

# NI 43-101 Mineral Resource Estimate of the Eaglehead Project



**Central Eaglehead Project Northwest British Columbia**

*Centred at 6,481,505 N and 495,804 E  
(NAD 83, Zone 9)*

Submitted to:

**Copper Fox Metals Inc.**

Suite 650, 340 – 12<sup>th</sup> Avenue SW

Calgary, Alberta

T2R 1L5

**Effective Date: August 21, 2023**

**Submission Date: October 10, 2023**

Submitted by:

**Moose Mountain Technical Services**

**Sue Bird, P.Eng.**

#210 1510-2<sup>nd</sup> St. North

Cranbrook, B.C., V1C 3L2, Canada

Tel: 250.489.1212

Email: [sueb@moosemmc.com](mailto:sueb@moosemmc.com)



## DATE & SIGNATURE PAGES

Herewith, the report entitled 'NI 43-101 Technical Report on the Eaglehead Project' effective date August 21, 2023.

*"Originals Signed and Sealed"*

---

Sue Bird, M.Sc., P.Eng.  
Moose Mountain Technical Services

---

Dated the 10<sup>th</sup> of October 2023

## **CERTIFICATE OF QUALIFIED PERSON – SUE BIRD**

I, Sue Bird, P.Eng., am employed as a Geological Engineer with Moose Mountain Technical Services, with an office address of #210 1510 2nd Street North Cranbrook, BC V1C 3L2. This certificate applies to the technical report titled “NI 43-101 Mineral Resource Estimate for the Eaglehead Project” that has an effective date of August 21, 2023 (the “technical report”).

- I am a member of the self-regulating Association of Professional Engineers and Geoscientists of British Columbia (#25007). I graduated with a Geologic Engineering degree (B.Sc.) from the Queen’s University in 1989 and a M.Sc. in Mining from Queen’s University in 1993.
- I have worked as an engineering geologist for over 25 years since my graduation from university. I have worked on precious metals, base metals and coal mining projects, including mine operations and evaluations. Similar resource estimate projects specifically include those done for Berg’s Surge Project, Gold Mining’s Whistler Project, Artemis’ Blackwater gold project, Ascot’s Premier Gold Project, Spanish Mountain Gold, all in BC; as well as numerous due diligence gold projects in the southern US done confidentially for various clients.
- As a result of my experience and qualifications, I am a Qualified Person as defined in National Instrument 43–101 Standards of Disclosure for Mineral Projects (NI 43–101).
- I visited the property on August 28, 2022.
- I am responsible for all Sections of the technical report, including Sections 1 through 27 and the Appendix.
- I am independent of Copper Fox Metals Inc. as independence is described by Section 1.5 of NI 43–101.
- I have had no previous involvement in the Eaglehead project.
- I have read NI 43–101 and the sections of the technical report for which I am responsible have been prepared in compliance with that Instrument.

As of the effective date of the technical report, to the best of my knowledge, information and belief, the sections of the technical report for which I am responsible contain all scientific and technical information that is required to be disclosed to make the technical report not misleading.

**Dated: 10<sup>th</sup> October 2023**

*“Signed and Sealed”*

---

Signature of Qualified Person

**Sue Bird, P.Eng.**

## TABLE OF CONTENTS

<b>1</b>	<b>Summary .....</b>	<b>13</b>
1.1	Mineral Resource Estimate .....	13
1.2	Project Location, Description and Ownership.....	14
1.3	History .....	14
1.4	Geology, Alteration and Mineralization .....	16
1.4.1	Alteration and Mineralization .....	17
1.4.2	Mineralization .....	17
1.5	Deposit Type.....	18
1.6	Drilling and Re-assessment of Historic Drillholes.....	18
1.7	Sample Preparation, Security and Analysis .....	19
1.8	Data Verification.....	19
1.9	Metallurgical Testing .....	20
1.10	Conclusions and Recommendations .....	20
<b>2</b>	<b>Introduction .....</b>	<b>22</b>
2.1	Purpose of Report and Terms of Reference .....	22
2.2	Sources of Information.....	22
2.3	Site Visits and Scope of Personal Inspections .....	22
<b>3</b>	<b>Reliance on Other Experts .....</b>	<b>23</b>
<b>4</b>	<b>Property Description and Location.....</b>	<b>24</b>
4.1	Location and Description.....	24
4.2	Tenure and Ownership .....	24
4.2.1	Tenure .....	24
4.2.2	Ownership .....	27
4.3	Historical Ownership Dispute .....	30
4.4	Community and Local Relations .....	31
4.5	Permitting, Environmental Liabilities and Other Issues .....	31
<b>5</b>	<b>Accessibility, Climate, Local Resources, Infrastructure and Physiography.....</b>	<b>33</b>
5.1	Access .....	33
5.2	Climate.....	33
5.3	Local Resources .....	33
5.4	Infrastructure .....	33
5.5	Physiography and Vegetation .....	35
<b>6</b>	<b>History.....</b>	<b>37</b>
6.1	Assessment of Historic Exploration Data .....	55
<b>7</b>	<b>Geological Setting and Mineralization .....</b>	<b>59</b>
7.1	Geological and Structural Setting.....	59
7.2	Property Geology.....	63
7.2.1	Eaglehead Pluton .....	63
7.2.2	Intrusive Rocks .....	63
7.2.3	Quesnel Terrane Lithologies .....	66
7.2.4	Hornblende Quartz Diorite (HQDT) ( <i>U-Pb Age: 195.090 ± 0.13 Ma</i> ).....	66
7.2.5	Quartz Porphyry (QP) ( <i>U-Pb Age: 194.852 ± 0.098 Ma</i> ) .....	66
7.2.6	Biotite Granodiorite (BGD).....	67
7.2.7	Late-Stage Dikes.....	67
7.2.8	Cache Creek Terrane Lithologies - Volcanic and Sedimentary Rocks .....	69
7.3	Alteration and Mineralization .....	70
7.3.1	Alteration .....	70
7.3.2	Mineralization .....	71
7.4	Descriptions of Mineralized Zones .....	74

7.4.1	Far East Zone.....	74
7.4.2	East Zone.....	77
7.4.3	Bornite Zone.....	84
7.4.4	Pass Zone .....	90
7.4.5	Camp Zone .....	96
7.4.6	West Zone .....	97
<b>8</b>	<b>Deposit Types .....</b>	<b>99</b>
<b>9</b>	<b>Exploration .....</b>	<b>103</b>
9.1	2021 Exploration .....	103
9.1.1	Logging of Historical Drill Core - 2021.....	103
9.1.2	Drillhole Summaries - 2021.....	104
9.1.3	Lithology Re-logging - 2021.....	106
9.1.4	Mineralization Re-logging - 2021 .....	106
9.1.5	Alteration Re-logging - 2021 .....	106
9.1.6	Surface Mapping- 2021.....	106
9.1.7	2021 Geophysical Survey: .....	107
9.1.8	Airborne Magnetic Survey - 2021 .....	108
9.1.9	Magnetic Vector Inversion Study - 2021.....	108
9.1.10	Baseline Water Quality Survey - 2021 .....	109
9.2	2022 Exploration .....	109
9.2.1	Age Dating - 2022.....	110
9.2.2	Archaeology Survey - 2022 .....	111
9.2.3	Re-logging and Sampling Program - 2022 .....	111
9.2.4	Mapping Program - 2022 .....	115
9.2.5	Water Surveys - 2022.....	115
<b>10</b>	<b>Drilling.....</b>	<b>116</b>
10.1	Drilling by Previous Operators.....	116
10.2	Drilling by District Copper .....	117
10.3	Summary Comments .....	117
10.4	Mineralized Intervals.....	117
10.4.1	Bornite Zone .....	123
10.4.2	Pass Zone .....	127
10.4.3	Camp Zone.....	129
10.4.4	West Zone.....	131
<b>11</b>	<b>Sample Preparation, Analyses and Security .....</b>	<b>132</b>
11.1	1965 to 1981 Programs .....	132
11.2	2006 to 2008 Programs .....	132
11.3	2011 Program .....	133
11.3.1	Blanks Performance - 2011.....	134
11.3.2	Standards Performance - 2011 .....	137
11.3.3	Duplicate Performance - 2011.....	139
11.4	2014 and 2015 Programs .....	141
11.4.1	Core Re-logging and Re-sampling procedures.....	142
11.4.2	Blanks Performance – 2014-2015.....	143
11.4.3	Standards Performance – 2014-2015.....	145
11.4.4	Duplicates Performance – 2014-2015 Program .....	147
11.4.5	Check-assay Performance – 2014-2015 .....	149
11.5	2016-2018 Resampling of Historical Core and re-assaying of pulps .....	151
11.5.1	Blanks Performance – 2015-2018.....	152
11.5.2	Standards Performance – 2015-2018.....	154

11.5.3	Duplicate Performance – 2015-2018.....	156
11.6	Resampling and Check-assays by ALS - 2021-2022 .....	158
11.6.1	Blanks Performance – 2021-2022.....	159
11.6.2	Standards Performance – 2021-2022 .....	160
11.6.3	Duplicate Performance – 2021-2022.....	162
11.6.4	Check-assay SGS Aqua Regia vs. ALS 4-acid – 2021-2022.....	162
11.7	Quality Assurance/Quality Control Procedures – 2017 .....	164
11.8	Adequacy of Sample Preparation, Security and Analytical Procedures.....	165
<b>12</b>	<b>Data Verification.....</b>	<b>167</b>
12.1	Assay database Review and Validation 2023 .....	167
<b>13</b>	<b>Mineral Processing and Metallurgical Testing .....</b>	<b>171</b>
13.1	Summary .....	171
13.2	Metallurgical Testing .....	172
13.2.1	Bond Ball Mill Grindability Test .....	172
13.2.2	Bond Abrasion Test.....	172
13.2.3	Mineralogy.....	172
13.2.4	Flotation.....	172
13.2.5	Rougher Flotation Testing .....	173
13.2.6	Cleaner Flotation Testing.....	174
13.2.7	Locked Cycle Flotation Testing .....	175
<b>14</b>	<b>Mineral Resource Estimate.....</b>	<b>177</b>
14.1	Key Assumptions and Data used in the Resource Estimate .....	178
14.2	Geologic Modelling.....	179
14.3	Capping and Assay / Composite Statistics.....	180
14.4	Compositing.....	183
14.5	Specific Gravity Assignment .....	186
14.6	Variography .....	187
14.7	Block Modelling.....	189
14.8	Classification.....	190
14.9	Model Validation .....	190
14.9.1	Global Grade Validation.....	190
14.9.2	Grade-Tonnage Curves .....	191
14.9.3	Visual Comparisons.....	193
14.10	Reasonable Prospects of Eventual Economic Extraction .....	197
14.11	Independent Check .....	199
14.12	Risk Assessment .....	200
<b>15</b>	<b>Mineral Reserve Estimates .....</b>	<b>201</b>
<b>16</b>	<b>Mining Method.....</b>	<b>202</b>
<b>17</b>	<b>Recovery Methods .....</b>	<b>203</b>
<b>18</b>	<b>Project Infrastructure.....</b>	<b>204</b>
<b>19</b>	<b>Market Studies and Contracts .....</b>	<b>205</b>
<b>20</b>	<b>Environmental Studies, Permitting and Social or Community Impact .....</b>	<b>206</b>
<b>21</b>	<b>Capital and Operating Costs .....</b>	<b>207</b>
<b>22</b>	<b>Economic Analysis.....</b>	<b>208</b>
<b>23</b>	<b>Adjacent Properties .....</b>	<b>209</b>
<b>24</b>	<b>Other Relevant Data and Information.....</b>	<b>210</b>
<b>25</b>	<b>Interpretation and Conclusions .....</b>	<b>211</b>
25.1	Mineral Resource Estimate .....	211
25.2	Geology and Exploration .....	211
25.3	Risks, Opportunities and Uncertainties.....	211

25.3.1	Risks and Uncertainties.....	211
25.3.2	Opportunities.....	212
<b>26</b>	<b>Recommendations .....</b>	<b>213</b>
26.1	Surveying .....	213
26.2	Bedrock Mapping .....	213
26.3	Geophysical Surveys.....	213
26.4	Deposit Modelling .....	213
26.5	Metallurgical Testwork.....	213
26.6	Diamond Drilling.....	214
<b>27</b>	<b>References.....</b>	<b>216</b>

## LIST OF TABLES

Table 1-1:	2023 Mineral Resource Estimate, Eaglehead Project .....	13
Table 1-2:	Proposed Budget for Recommended Exploration Program – Phase 1 .....	21
Table 1-3:	Proposed Budget for Recommended Exploration Program – Phase 2 .....	21
Table 4-1:	Eaglehead Mineral Claim Summary .....	26
Table 4-2:	Terms and Conditions of Royalty tied to Mineral Tenures, Eaglehead Project .....	29
Table 6-1:	Summary of Exploration Activities, Eaglehead Project.....	56
Table 7-1:	Weighted average metal concentrations by zone from Southeast to Northwest, ..... Eaglehead project. ....	73
Table 7-2:	Summary of Alteration and Mineralization by Zone, from Southeast to Northwest, Eaglehead Project .....	73
Table 9-1:	Summary of Drillholes Re-logged and Sampled in 2021 .....	104
Table 9-2:	2021 Analytical Core sampling - Far East Zone .....	105
Table 9-3:	Summary of drillholes re-logged in 2022. Eaglehead project.....	113
Table 9-4:	Analytical results of the 2022 drill core sampling program, Eaglehead project .....	115
Table 10-1:	Holes and Metres Drilled by Zone, Eaglehead Project.....	117
Table 10-2:	Selected Drillhole Results - Far East Zone .....	118
Table 10-3:	Drillhole Results - East Zone.....	119
Table 10-4:	Drillhole Results - Bornite Zone .....	123
Table 10-5:	Drillhole results - Pass Zone .....	127
Table 10-6:	Drillhole Results - Camp Zone .....	129
Table 10-7:	Drillhole Results, West Zone, Eaglehead Project .....	131
Table 11-1:	Drill Programs by Year, Eaglehead Project.....	132
Table 11-2:	QAQC Insertion Rate - 2011 .....	134
Table 11-3:	QAQC Insertion Rate – 2014 - 2015 .....	141
Table 11-4:	QAQC Insertion Rate – 2015-2018 Program .....	152
Table 11-5:	QAQC Insertion Rate – 2021 - 2022 .....	158
Table 11-6:	Quality Control Sample Insertion Rate Summary (after Amec Foster Wheeler, 2016) .. .....	165
Table 12-1:	Verification Sample Summary by Zone - 2017 .....	168
Table 13-1:	Analysis of Head Samples Used in the Test Works .....	172
Table 13-2:	Results of the Three Stages Cleaner Flotation Testing .....	175
Table 13-3:	Locked Cycle Test Results Yielded the Following Results .....	176
Table 14-1:	2023 Mineral Resource Estimate, Eaglehead Project .....	177
Table 14-2:	Summary of Drillholes and Assays used in the Eaglehead Resource Estimate .....	178
Table 14-3:	Capping and Outlier Restriction by Domain.....	181
Table 14-4:	Summary of Capped Assay and Composites Statistics by Domain .....	185
Table 14-5:	Specific Gravity Measurements by Lithology.....	186
Table 14-6:	Eaglehead Block Model Extents .....	189
Table 14-7:	Summary of Search Orientations and Distances for each Pass .....	189
Table 14-8:	Model Validation of Global Model Grades with De-clustered Composites.....	191
Table 14-9:	Metal Prices, Recoveries, Smelter Terms and Net Smelter Price (NSP).....	198
Table 14-10:	List of Risks and Mitigations/Justifications .....	200
Table 26-1:	Proposed Budget for Recommended Exploration Program – Phase 1 .....	215
Table 26-2:	Proposed Budget for Recommended Exploration Program – Phase 2 .....	215



## LIST OF FIGURES

Figure 4-1:	Eaglehead Project Location Map .....	25
Figure 4-2:	Mineral Tenure Map, Eaglehead project .....	27
Figure 4-3:	Tenure Royalty Holdings – Eaglehead Project .....	30
Figure 5-1:	Core Storage (lower left) and Camp (lower right), Eaglehead Project .....	34
Figure 5-2:	Looking Southward Over the Central Part of the Eaglehead Project.....	35
Figure 5-3:	Physiography of Mineralized zones Eaglehead project .....	36
Figure 6-1:	Northwest Trending Copper Soil Geochemical Anomaly, Eaglehead Project (after Ikona, 2004b) .....	40
Figure 6-2:	Total magnetic intensity map with location of mineralized zones. Turnagain Nickel Project (Giga Metals Corp.) included for spatial reference. ....	41
Figure 6-3:	TMI Base with Claim Boundary, Geology and Mineralized Zones (after Quist, 2015; Poon, 2014) .....	42
Figure 6-4:	Low Th/K Signature of the Central Eaglehead Pluton.....	43
Figure 6-5:	Location of 2014 IP Grid, Eaglehead Project.....	43
Figure 6-6:	Quantec Cross-sections of the 2D Chargeability Inversion Superimposed by the 3D Chargeability Inversion isosurfaces of 40 mrad (pink) and 35 mrad (purple) .....	44
Figure 6-7:	Plan Map of IP Chargeability (DC referenced) for Depths of 200m and 250m (after Quantec, 2014).....	45
Figure 6-8:	Plan Map of IP Chargeability (DC referenced) for Depths of 300m and 400m (after Quantec, 2014).....	46
Figure 6-9:	Plan Map of IP Chargeability (HS referenced) showing a number of Quantec’s Priority Targets (after Quantec, 2014).....	47
Figure 6-10:	2021 geophysical survey- chargeability anomaly Eaglehead project .....	49
Figure 6-11:	Combined 2021 and 2014 survey results.....	50
Figure 6-12:	MVI at 600m depth. Location of interpreted intrusive centers near drilling. ....	51
Figure 6-13:	Magnetic Vector Inversion anomaly map at 200m level below surface, Eaglehead project. ....	52
Figure 6-14:	Magnetic Vector Inversion anomaly map at 600m level below surface, Eaglehead project. ....	52
Figure 6-15:	Copper in soil geochemical anomaly, Eaglehead project. ....	53
Figure 6-16:	Geological model of mineralized corridor, Eaglehead project. ....	54
Figure 6-17:	Alteration model, mineralized corridor, Eaglehead project. ....	54
Figure 7-1:	Simplified Terrane Map of the British Columbia showing Distribution of Select Alkalic and Calc-alkalic Porphyry Deposits .....	60
Figure 7-2:	Regional Geology and Structural Elements of the Eaglehead Project Area (after Gabrielse, 1994) .....	61
Figure 7-3:	Regional Geology Legend for Figure 7-2 .....	62
Figure 7-4:	Total Alkali vs Silica geochemistry of the Pass, Bornite and East mineralized zones, Eaglehead project. ....	64
Figure 7-5:	Plots of Sr/Y vs. Y for samples from the Eaglehead Project.....	65
Figure 7-6:	Calc-alkaline and Alkalic Porphyry Type comparison with the Eaglehead Project. ....	66
Figure 7-7:	Classification of mafic dikes from the East and Pass Zones, Eaglehead project. IUGS Classification for Volcanic Rocks. ....	68
Figure 7-8:	3D model of the geology and Location of Mineralized Zones, Eaglehead Project .....	70
Figure 7-9:	Generalized Alteration zonation by mineralized zone; Eaglehead project.....	71
Figure 7-10:	Interpreted bedrock geology, Far East Zone, Eaglehead project.....	75
Figure 7-11:	Drillhole Locations, Far East Zone, Eaglehead Project .....	76

Figure 7-12:	Representative geological cross-section of the East Zone at approximately 495000E (Section NE-SW) with corresponding mineralization.....	78
Figure 7-13:	Distribution of alteration zonation and copper/molybdenum shell along approximately 495000E (NE-SW) of the East zone, Eaglehead project.....	79
Figure 7-14:	Mixed Potassic (k-feldspar) and Phyllic (sericite) Alteration, East zone, DDH 107, centered at 194.0 m (Lane, 2019).....	80
Figure 7-15:	Copper shell superimposed on the 2014 Quantec geophysical chargeability signature - Approximate Section 495000E (NE-SW). ....	81
Figure 7-16:	Chalcopyrite mineralization with associated mafics in the East Zone.....	82
Figure 7-17:	Close-up of Core Displaying Two Orientations (parallel to core axis and at 30° to core axis) of Quartz-chalcopyrite+/-molybdenite veinlets (with potassic halo), East Zone, DDH 107 at 194.2m (Lane, 2019).....	83
Figure 7-18:	Drillhole Locations, East Zone, Eaglehead Project.....	84
Figure 7-19:	Bornite Zone Cross Section with Mineralized Envelope >0.05% Cu. Section 494000E (NE-SW).....	85
Figure 7-20:	Generalized alteration model in relation to copper/molybdenum shells, Bornite Zone. Section 494000E (NE-SW). ....	86
Figure 7-21:	Interpreted Copper shell superimposed on Quantec geophysical chargeability signature). Approximate Section 494000E (NE-SW).....	87
Figure 7-22:	Bornite-chalcopyrite mineralization within intensely potassic altered zone, Bornite Zone, DDH 74 at 315.0m.....	89
Figure 7-23:	Drillhole Locations, Bornite Zone, Eaglehead Project.....	89
Figure 7-24:	Generalized geology with superimposed copper shell (0.05% Cu cutoff) Pass zone. Approximate Section 493000E (NE-SW).....	90
Figure 7-25:	Hydrothermal (magmatic) Breccia: Intergrown Chalcopyrite-pyrite as Matrix to Sub-rounded Clasts of Potassic-altered Intrusive Rock, Pass Zone, hole 53 centered at 70.0m.....	92
Figure 7-26:	Generalized alteration zonation and copper shell (0.05% Cu cutoff) on Section 493000E (NE-SW), Pass zone, Eaglehead project. ....	93
Figure 7-27:	Weak Propylitic Alteration, Biotite Hornblende Granodiorite, Pass Zone, hole 48 at 131.4m.....	94
Figure 7-28:	Drillhole location map, Pass Zone.....	95
Figure 7-29:	Drillholes for the Camp zone are shown on the east side of the Figure. The West Zone (discussed below is shown to the west (DDH 56 and DDH 57).....	97
Figure 8-1:	Generalized Model for a Telescoped Porphyry Copper System.....	101
Figure 8-2:	Generalized Alteration-mineralization Zoning for a Telescoped Porphyry Copper System.....	102
Figure 9-1:	Location of drillholes re-logged and sampled in 2021. Eaglehead Project.....	104
Figure 9-2:	Chargeability anomaly outlined by 2021 Quantec geophysical survey, Eaglehead project.....	107
Figure 9-3:	Merged 2014 and 2021 Quantec geophysical survey data, Eaglehead project.....	108
Figure 9-4:	Magnetic Vector Inversion anomalies identified in 2021. Eaglehead project.....	109
Figure 9-5:	Timing of Eaglehead intrusion in relation to emplacement of other porphyry systems in British Columbia.....	111
Figure 9-6:	Location of drillholes re-logged in 2022.....	112
Figure 9-7:	Locations of drillholes reviewed in 2022, Eaglehead Project.....	114
Figure 10-1:	Distribution of Diamond Drillholes, Eaglehead Project (insets refer to drillhole location maps in Section 7).....	116
Figure 11-1:	Blanks from 2011 Program - Cu.....	135
Figure 11-2:	Blanks from 2011 Program - Mo.....	135

Figure 11-3:	Blanks from 2011 Program - Ag .....	136
Figure 11-4:	Blanks from 2011 Program - Ag .....	137
Figure 11-5:	Standard Performance from 2011 Program - Cu .....	138
Figure 11-6:	Standard Performance from 2011 Program - Mo .....	138
Figure 11-7:	Standard Performance from 2011 Program - Au .....	139
Figure 11-8:	Standard Performance from 2011 Program - Ag .....	139
Figure 11-9:	Duplicate Performance from 2011 Program – Cu.....	140
Figure 11-10:	Duplicate Performance from 2011 Program – Mo .....	140
Figure 11-11:	Duplicate Performance from 2011 Program – Ag.....	140
Figure 11-12:	Duplicate Performance from 2011 Program – Au.....	141
Figure 11-13:	Blanks from 2014-2015 Program - Cu .....	143
Figure 11-14:	Blanks from 2014-2015 Program - Mo.....	144
Figure 11-15:	Blanks from 2014-2015 Program - Ag.....	144
Figure 11-16:	Blanks from 2014-2015 Program - Au.....	145
Figure 11-17:	Standard Performance from 2014-2015 Program - Cu .....	146
Figure 11-18:	Standard Performance from 2014-2015 Program - Mo.....	146
Figure 11-19:	Standard Performance from 2014-2015 Program - Ag.....	147
Figure 11-20:	Standard Performance from 2014-2015 Program - Au.....	147
Figure 11-21:	Duplicate Performance from 2014-2015 Program – Cu .....	148
Figure 11-22:	Duplicate Performance from 2014-2015 Program – Mo .....	148
Figure 11-23:	Duplicate Performance from 2014-2015 Program - Au .....	148
Figure 11-24:	Duplicate Performance from 2014-2015 Program - Ag .....	149
Figure 11-25:	Check Assays of Coarse Rejects – 2014-2015 .....	150
Figure 11-26:	Check Assays of Pulps – 2014-2015 .....	151
Figure 11-27:	Blank Performance from 2015-2018 Program - Mo .....	153
Figure 11-28:	Blank Performance from 2015 - 2018 Program - Au.....	153
Figure 11-29:	Standard Performance from 2015 - 2018 Program - Cu .....	154
Figure 11-30:	Standard Performance from 2015 - 2018 Program - Mo.....	155
Figure 11-31:	Standard Performance from 2015 - 2018 Program - Ag .....	155
Figure 11-32:	Standard Performance from 2015 - 2018 Program – Au .....	156
Figure 11-33:	Duplicate Performance from 2015 - 2018 Program – Cu.....	157
Figure 11-34:	Duplicate Performance from 2015 - 2018 Program – Mo .....	157
Figure 11-35:	Duplicate Performance from 2015 - 2018 Program – Ag.....	157
Figure 11-36:	Duplicate Performance from 2015 - 2018 Program – Au .....	158
Figure 11-37:	Blank Performance from 2021 - 2022 Program - Ag.....	159
Figure 11-38:	Blank Performance from 2021 - 2022 Program - Cu.....	160
Figure 11-39:	Standard Performance from 2021-2022 Program – Cu .....	160
Figure 11-40:	Standard Performance from 2021-2022 Program – Mo.....	161
Figure 11-41:	Standard Performance from 2021-2022 Program – Ag .....	161
Figure 11-42:	Standard Performance from 2021-2022 Program – Au .....	162
Figure 11-43:	Check Assays – 2021-2022 – Cu .....	163
Figure 11-44:	Check Assays – 2021-2022 – Mo.....	164
Figure 11-45:	Check Assays – 2021-2022 – Ag .....	164
Figure 12-1:	Check Assays from 2017 - Cu .....	169
Figure 12-2:	Check Assays from 2017 - Mo .....	169
Figure 12-3:	Check Assays from 2017 - Ag .....	170
Figure 12-4:	Check Assays from 2017 - Au .....	170
Figure 13-1:	Test Works Flowchart .....	173
Figure 13-2:	Time versus Percentage Recovery Curves for Copper and Molybdenite .....	174

Figure 14-1:	Plan view of Drillholes by Year Drilled (top) and by Year Re-Assayed (bottom) with Outline of the Resource Pit .....	179
Figure 14-2:	Modelled Domains and Resource Pit .....	180
Figure 14-3:	Cumulative Probability Plot of Assays - Cu .....	181
Figure 14-4:	Cumulative Probability Plot of Assays – Mo .....	182
Figure 14-5:	Cumulative Probability Plot of Assays - Au .....	182
Figure 14-6:	Cumulative Probability Plot of Assays - Ag .....	183
Figure 14-7:	Histogram of Assay Lengths .....	184
Figure 14-8:	Variogram Models for Domain 1 and 2 - Cu – Major Axes .....	188
Figure 14-9:	Three-dimensional view of the resource pit with the Classification (Indicated in green, Inferred in Yellow).....	190
Figure 14-10:	Grade-Tonnage Curve Comparison for Cu – Domain 1.....	192
Figure 14-11:	Grade-Tonnage Curve Comparison for Cu – Domain 2.....	192
Figure 14-12:	Composites (+/- 25m) and Model Grades at 4938350E - Cu .....	193
Figure 14-13:	Composites (+/- 25m) and Model Grades at 494040E - Cu .....	194
Figure 14-14:	Composites (+/- 25m) and Model Grades at 494040E – Au .....	195
Figure 14-15:	Composites (+/- 25m) and Model Grades at 495260E – Mo .....	196
Figure 14-16:	Composites (+/- 25m) and Model Grades at 495260E – Ag.....	197
Figure 14-17:	Three-dimensional view looking NW of the Resource Pit showing Modelled NSR above Cutoff .....	199
Figure 23-1:	Location of Turnagain Property in Relation to the Eaglehead Project .....	209

## 1 Summary

Copper Fox Metals Inc. (Copper Fox) on behalf of its wholly owned subsidiary Northern Fox Copper Inc. (Northern Fox) retained Moose Mountain Technical Services (MMTS) to prepare a National Instrument 43-101 (NI 43-101) Mineral Resource Estimate for the Eaglehead Copper-Molybdenum-Gold-Silver Project, located in the Cassiar region of northwest British Columbia, Canada. The Project has an intermittent history of exploration that dates to 1963. This Technical Report provides a resource estimate of the deposit as well as summaries of project history, geology, mineralization, deposit characteristics; exploration targets, and makes recommendations for future work.

### 1.1 Mineral Resource Estimate

The Resource Estimate for the Eaglehead project, as prepared by MMTS is summarized in the Table below. The effective date of the Resource Estimate is August 21, 2023. Parameters used to define the “reasonable prospects of eventual economic extraction” pit are summarized in the Notes to the Table.

**Table 1-1: 2023 Mineral Resource Estimate, Eaglehead Project**

Class	NSR Cutoff (CDN\$ /tonne)	Tonnage (kt)	In situ Grade						In situ Metal					
			NSR (CDN\$ /tonne)	CuEqv %	Cu %	Mo %	Au gpt	Ag gpt	NSR M\$	CuEqv Mlbs	Cu Mlbs	Mo Mlbs	Au koz	Ag koz
Indicated	5	71,971	24.422	0.322	0.219	0.0107	0.060	0.9	1,758	510	347	17.0	139.8	2,159
	5.5	70,810	24.737	0.326	0.221	0.0108	0.061	0.9	1,752	509	345	16.9	139.6	2,151
	8	64,395	26.524	0.349	0.236	0.0118	0.066	1.0	1,708	496	335	16.8	137.5	2,093
	10	58,210	28.383	0.374	0.251	0.0128	0.072	1.1	1,652	480	322	16.4	134.6	2,021
	15	43,415	33.832	0.446	0.293	0.0161	0.089	1.3	1,469	427	280	15.4	123.8	1,798
	20	30,454	40.823	0.538	0.344	0.0207	0.112	1.6	1,243	361	231	13.9	109.2	1,530
Inferred	5	250,820	18.188	0.240	0.187	0.0035	0.042	0.6	4,562	1,325	1,036	19.4	339.5	5,024
	5.5	242,331	18.641	0.246	0.192	0.0035	0.043	0.6	4,517	1,312	1,025	18.7	335.8	4,971
	8	202,996	20.95	0.276	0.215	0.0040	0.049	0.7	4,253	1,235	964	17.9	318.5	4,660
	10	175,071	22.861	0.301	0.234	0.0044	0.054	0.8	4,002	1,163	905	17.0	302.8	4,379
	15	118,277	27.907	0.368	0.283	0.0056	0.068	0.9	3,301	959	739	14.6	260.1	3,590
	20	78,227	33.32	0.439	0.334	0.0069	0.086	1.1	2,607	757	576	11.9	215.5	2,814

#### Notes to the Resource Table:

- The Mineral Resource Estimate has been prepared by Sue Bird, P.Eng., an independent Qualified Person.
- Resources are reported using the 2014 CIM Definition Standards and were estimated in accordance with the CIM 2019 Best Practices Guidelines.
- Mineral Resources that are not Mineral Reserves do not have demonstrated economic viability.
- The Mineral Resource has been confined by a “reasonable prospects of eventual economic extraction” pit using the following assumptions:
  - Cu price of US\$3.50/lb, Mo price of US\$20.00/lb, Au price of US\$1,750/oz, Ag price of US\$20/oz at an exchange rate of 0.77 US\$ per C\$.
  - 97% for Cu and Au, 90.0% payable for Ag, 99.0% payable for Mo, 1% Unit deduction for Cu and Mo, Cu concentrate smelting of US\$120/wmt, US\$0.10/lb Cu refining and transport of US\$100/t. For Mo smelting costs of US\$2.5/wmt con, US\$1.52/lb Mo refining, and US\$154.05/wmt transport, Au refining of US\$8.00/oz with Ag refining of US\$0.50/oz with transportation costs included in the Cu con.
  - Recoveries for Cu, Mo, Au, and Ag of 89.9%, 71.1%, 78.6% and 78.1% respectively.
- Resulting NSR equation is:  $NSR = 22.0462 * (Cu\% * CDN\$3.83/lb * 89.9\% + Mo\% * CDN\$23.58 * 71.1\%) + Augpt * CDN\$70.55/g * 78.6\% + Aggpt * CDN\$ 0.74/g * 78.1\%$
- $CuEq = Cu\% + Mo\% * 4.870 + Augpt * 0.7308 + Aggpt * 0.0076$
- Mining costs of C\$1.50/t.
- Processing, G&A, and tailings management costs of C\$5.50/t.
- Pit slopes of 50 degrees.
- Numbers may not sum due to rounding.

The following factors, among others, could affect the Mineral Resource estimate: commodity price and exchange rate assumptions; pit slope angles; assumptions used in generating the LG pit shell, including metal recoveries, and mining and process cost assumptions. The QP is not aware of any environmental, permitting, legal, title, taxation, socioeconomic, marketing, political, or other relevant factors that could materially affect the Mineral Resource estimate.

## **1.2 Project Location, Description and Ownership**

The Eaglehead Project lies within the Cry Lake map area, approximately 40km east of the small community of Dease Lake. The Project is centered at Latitude 58° 28' 27" N and Longitude 129° 4' 19" W, or 495804m E and 6481505m N (UTM NAD83, Zone 9), and covers parts of three NTS 1:50,000 scale map sheets 104I/6, 104I/7 and 104I/11.

The Project tenure follows a U-shaped glacial valley situated between two mountain ranges that in part comprise the Stikine Ranges of the Cassiar Mountains. The main areas of interest follow a northwesterly trend and lie southeast of Eaglehead Lake and northwest of the Turnagain River. The Project encompasses six principal zones of porphyry copper-molybdenum-gold-silver mineralization, the Far East, East, Bornite, Pass, Camp and West zones.

The Eaglehead Project is comprised of eleven contiguous mineral claims that cover 15,712.91 hectares (15km<sup>2</sup>) of land in the Liard Mining Division. The claims are 100%-owned by Northern Fox Copper Inc. (Northern Fox). The Project is subject to three Net Smelter Return (NSR) royalties on future production: a 2.5% NSR on the entire mineral tenure; a 0.5% NSR on the entire property, a 2% NSR on a 981-hectare portion of the mineral tenure and a 2% Net Milling Royalty Return (NMRR) on another 2,416-hectare portion of the mineral tenure. The claims are in good standing with anniversary dates ranging from April 1, 2025 until December 1, 2029. Copper Fox Metals Inc., through its wholly-owned subsidiary Northern Fox Copper Inc., owns 15.6% of the issued and outstanding shares of District Copper.

Access to the Project is primarily by helicopter. A seasonal 4x4 road leading eastward from Dease Lake to Boulder City, and then north to the Project may be upgraded for regular use in the future.

## **1.3 History**

Mineral exploration on the Eaglehead Project primarily took place during three periods: from discovery in 1963 to 1965, from 1970 to 1982, and from 2005 to 2018, the latter phase of which is still ongoing.

Exploration on the Project began in 1963 when Kennco Explorations Ltd. (Kennco) staked the Joy 1-32 claims to cover showings of copper mineralization it had discovered in association with a geochemical anomaly. From 1963-1965, Kennco conducted geological mapping, geochemical surveys and trenching, airborne and ground geophysical surveys, and completed two diamond drillholes in each of the Pass and Camp zones.

In 1970, after a five-year exploration hiatus in which the claims were allowed to lapse, Spartan Exploration Ltd., later reorganized as Nuspar Resources Ltd. (Nuspar), staked the property, and optioned it to Imperial Oil Limited, predecessor to Esso Minerals Canada Ltd. (Esso). Esso conducted geological, geochemical, and geophysical work from 1971-1976 and drilled 30 BQ-diameter core holes in the Camp, Pass and Bornite zones. In 1979, Nuspar became operator and conducted geochemical, geological, and Induced Polarization (IP) surveys and completed 5 BQ diamond drillholes. From 1980-1982, geochemical sampling, airborne VLF-EM, and magnetometer surveys, and 20 BQ diamond drillholes were completed. In 1982, Esso resumed operatorship of the Project and conducted

geological mapping, and geochemical and geophysical (IP) surveys. Limited work on the Project in 1990 and 1992 by Homestake Canada Inc. did not assess its porphyry potential; no other work was done, and the claims were allowed to lapse in 2001.

In 2002, J. Poloni staked the open ground and, over the next few years with partner E. Peters, established a control grid, conducted rock and soil sampling, and reviewed historic drill core. In 2005, they completed a 3D IP survey that identified two chargeability anomalies; later that year the Project was optioned to District Copper.

Work completed on the Eaglehead Project from 1963 – 2005 included:

- collection of more than 2,500 soil geochemical samples that outlined a semi-continuous, northwest-trending > 60 ppm copper anomaly with intermittent > 10 ppm molybdenum anomalies over an approximate 10km strike.
- more than 75 line-km of airborne magnetic and electromagnetic (EM) surveys
- ground geophysical surveys consisting of:
  - 78 line-km of IP surveys that outlined a northwest-trending chargeability anomaly coincident with the copper soil geochemical anomaly.
  - 30 line-km of magnetometer and EM surveys that did not detect any discernible conductors.
- a total of 59 diamond drillholes totaling 12,243.4m that encountered significant alteration and mineralization in five zones over 5km of strike length ranging from 0.1% Cu over 1.5m to 0.452% Cu over 152.7m.

In 2006, District Copper initiated a systematic exploration program on the Project that consisted of establishing 16km of useable road access from the Turnagain River to the Project, and completion of 10 NQ diamond drillholes on the Far East, East and Bornite zones. In 2007, a program consisting of 43.8 line-km of new survey grid, a 3D-IP survey that overlapped the 2005 survey, soil sampling and completion of 12 NQ diamond drillholes on the Far East, East and Bornite zones. In 2008, District Copper completed an additional 14 NQ diamond drillholes focussed on the East zone. In 2011, District Copper completed 25 NQ diamond drillholes on the Bornite and East zones and retained Rosco Postle Associates Inc. (RPA) to complete a NI 43-101 mineral resource estimate for the Project. In 2014, District Copper's work included four HQ diamond drillholes, an 18 line-km Titan24 geophysical survey, and a 767 line-km airborne magnetic and radiometric survey. Re-logging of historic drillholes was also initiated, and core samples from the East and Bornite zones were collected for preliminary rock characterization. In 2015, two NQ diamond drillholes were completed on the Pass zone, along with re-logging and sampling of 10 historic drillholes, and additional rock characterization studies.

Diamond drilling completed on the Eaglehead Project from 2006-2015 totaled 24,362.5m in 67 holes. The drilling targeted the Far East, East, Bornite and Pass zones, and intersected broad intervals of copper mineralization, some of which are accompanied by significant concentrations of molybdenum-gold-silver, including: 551.08m averaging 0.23% Cu, 0.013% Mo, 0.060 g/t Au, and 0.9 g/t Ag in hole 121 drilled in the East zone; 111.00m averaging 0.483% Cu, 0.020% Mo, , 0.276 g/t Au, and 1.4 g/t Ag in hole 116 drilled in the Bornite zone; 162.00m averaging 0.140% Cu, 0.010% Mo, 0.03 g/t Au, and 0.7 g/t Ag in hole 125 drilled in the Pass zone. Exploration has determined that these zones along with the Camp and West zones located northwest of, and along trend from, the Pass zone occur within a prospective, northwest-trending mineralized corridor from 0.5–1.5km wide and more than 8km long. The mineralized corridor is characterized by:

- a 10km long, semi-continuous copper soil geochemical anomaly

- a northwest trending belt of moderate magnetic response with small, irregular-shaped moderate-to-high magnetic features that coincides with the western margin of the Eaglehead pluton.
- a 6km long chargeability high anomaly, along which five zones of copper-molybdenum-gold-silver mineralization occur, that is open to the northwest towards the West zone and to the southeast toward the Far East zone. This anomaly averages 900m wide and is open below a depth of 500m.
- the Far East zone, located approximately 3,000m from the end of the chargeability anomaly, exhibits a 1,000m by 1,000m copper and molybdenum soil geochemical anomaly.
- moderate to intense potassic (principally K-feldspar), pervasive phyllic (sericitic) and late propylitic alteration of the mineralized intrusive host rocks
- mineralization, consisting primarily of chalcopyrite and bornite with minor molybdenite in quartz veins, quartz stockworks, and zones of fracturing and brecciation, that was emplaced in multiple phases.
- drilling that has intersected good grades of copper-molybdenum-gold-silver over narrow to wide intervals in 120 of 126 holes completed to-date.

In 2016, District Copper completed re-logging, sampling and/or re-sampling of either unsplit or split core intervals from 40 historical drillholes from the East, Bornite, Pass and Camp zones, re-analysis of approximately 15,000 pulp and core samples from drillholes completed prior to 2014, and preliminary metallurgical test work.

In 2018, District Copper Corp. completed a field program that included: i) re-logging, 36 historical diamond drillholes (7,789m); ii) sampling and re-sampling of 19 historical diamond drillholes (917 samples) for copper, molybdenum, gold, silver and a suite of trace elements ; iii) recovery of additional historical diamond drill core from the Camp zone; and iv) re-visiting previously mapped outcrops as part of a compilation reconnaissance program to obtain alteration data and determine controls on copper mineralization for a portion of the Eaglehead intrusion underlying the Camp zone and the area north of the Camp and Pass zones.

In 2021, Northern Fox Copper Inc. (Copper Fox) completed a field program consisting of i) re-logging five historical drillholes (1,828.9m) in the Far-East zone, ii) 293 core samples (659m of drill core), iii) 10.8 kms of chargeability/resistivity survey, iv) modelling and re-interpretation of the 2014 high sensitivity airborne magnetic survey and v) initiated a stream water sampling program to establish a stream water quality baseline for the project and vi) surface mapping of the geophysical lines and other portions of the property.

In 2022, Northern Fox Copper Inc. (Copper Fox) completed a field program consisting of i) re-logging of 34 historical drillholes, ii) sampling of 194.03 meters ('m') (20 mineralized intervals in 11 drillholes) of unsampled drill core, iii) re-analyses of 270 sample pulps utilizing a four-acid digestion, iv) review of 54 historical drillholes; v) reconnaissance scale mapping and prospecting; vi) age-dating and petrographic studies; vii) an archaeological assessment, viii) and stream water sampling to progress the stream water quality baseline analysis.

#### **1.4 Geology, Alteration and Mineralization**

The Eaglehead project is located at the southern margin of the Quesnel terrane immediately north of the terrane bounding fault that separates it from the Cache Creek terrane to the southwest. In the project area, the Quesnel terrane consists of a Triassic to Early Jurassic island arc assemblage dominated by the Eaglehead pluton. It is flanked to the north by Paleozoic sedimentary rocks of



Ancestral North America and to the south by an Upper Paleozoic oceanic assemblage of the Cache Creek terrane.

The Project covers the southwestern margin of the Eaglehead pluton, a zoned Early Jurassic batholith that is elongate in a northwest direction subparallel to the main structural grain in the area. The pluton is bounded on its northeast side by the Kutcho fault, a major northwest-trending fault with dextral lateral movement in the order of several tens of kilometers. The southwestern flank of the Eaglehead pluton is in structural contact along the Thibert fault with a sliver of bimodal volcanic and volcanoclastic rocks of the Lower Triassic Kutcho Assemblage and sedimentary rocks of the Whitehorse Trough belonging to the Cache Creek Terrane. The Kutcho Assemblage is stratigraphically overlain by sedimentary rocks of the Whitehorse Trough, including well-bedded greywacke, conglomerate, and siltstone of the Lower to Middle Jurassic Inklin Formation and thin-bedded limestone of the Upper Triassic Sinwa Formation. The Thibert fault is likely part of the Kutcho fault system, and these faults are interpreted to connect south of the Project near the Turnagain River.

The central part of the Eaglehead Project, as mapped by Caulfield in 1982, is subdivided into three phases; from south to north, the phases are: i) hornblende quartz diorite, ii) biotite granodiorite, and iii) porphyritic granodiorite. The intrusive phases are cut by aplitic dykes, pegmatitic dykes, diabase (mafic) dykes and quartz feldspar porphyry dykes. The diabase dykes and quartz feldspar porphyry dykes cross-cut areas of copper mineralization.

#### **1.4.1 Alteration and Mineralization**

Hydrothermal alteration associated with the porphyry mineralization at Eaglehead ranges from potassic to phyllic to propylitic. The alteration accompanying the mineralization in the Pass, Bornite and East zones is essentially similar. A brief description of the alteration styles is presented below.

- **Potassic alteration** (quartz + K-feldspar + secondary biotite, magnetite+/-hematite, calcite), occurs as envelopes around fractures, veins, quartz veinlets (which often contain chalcopyrite and/or bornite). Intense potassic alteration is typically accompanied by bornite and chalcopyrite in stringers, fractures, and veinlets, but can also occur in more intensely fractured or brecciated zones. Anhydrite veining also occurs in the potassic zone.
- **Phyllic alteration** (sericite-chlorite alteration) is characterized by a pale green silicified texture, with prominent muscovite grains (altered biotite). Fractures and veins within the phyllic alteration zone can contain chalcopyrite-bornite mineralization along with a combination of calcite, hematite, sericite, chlorite, and/or epidote.
- **Propylitic alteration** (pervasive epidote, epidote veinlets or epidote in veinlets with chlorite, albite veins, hematite, and pyrite). Propylitic alteration typically occurs over narrow intervals within zones of potassic and phyllic alteration.

#### **1.4.2 Mineralization**

Copper-bearing minerals (chalcopyrite and bornite) occur primarily in sheet-like fractures, quartz vein stockworks, breccia and fault zones with lesser amounts occurring as disseminated grains blebs and in biotite veins and associated with mafic mineral. Copper grade is typically a function of fracture/vein density. Late-mineral fault and breccia zones that exhibit intense potassic alteration typically contain higher concentrations of bornite and molybdenite. Molybdenite is primarily concentrated along shear planes, in breccia zones, and in quartz veinlets and in quartz-anhydrite veinlets. Malachite (and occasionally azurite, chrysocolla and chalcocite) is common near surface, and often occurs on fractures along with limonite and goethite. In general, mineralization consists of:

- An early phase of copper-silver (pervasive),
- A second phase of copper-gold-molybdenum-silver (that may be restricted in extent), and

- A third phase of copper-gold-molybdenum-silver (restricted to late fracture zones that exhibit intense potassic alteration).

The porphyry mineralization in the East and Bornite zones strike to the northwest and dips approximately 75 degrees to the north, No interpretation of the strike and dip of the mineralization in the Far East, Pass, Camp and West zones is provided primarily due to the short, shallow drillholes. Crudely defined sulphide species domains have been recognized in several of the mineralized zones. From the core of a mineralized zone to the periphery, the following general zonations are: bornite>chalcopyrite, chalcopyrite>bornite, chalcopyrite>pyrite, pyrite>chalcopyrite and pyrite can be observed.

## 1.5 Deposit Type

Mineralization on the Eaglehead Project is typical of a Calc-Alkalic style of porphyry copper-molybdenum-gold (Cu-Mo-Au) mineralization. Porphyry Cu-Mo-Au deposits are typically high tonnage (greater than 100 million tonnes) and low to medium grade (0.3–2.0% Cu). They are the world's most important source of copper and are an important source of other metals, most notably molybdenum, gold, and silver. Calc-Alkalic porphyry Cu-Mo-Au deposits consist of mineralization that is relatively evenly distributed throughout large volumes of rock. Mineralization is spatially, temporally, and genetically associated with hydrothermal alteration of the host rock intrusions and wall rocks. Intrusions range from coarse-grained phaneritic to porphyritic stocks, batholiths, and dike swarms. Compositions range from quartz diorite to granodiorite and quartz monzonite and can include multiple emplacements of successive intrusive phases and a wide variety of breccias.

Alteration can consist of a central and early formed potassic zone, that commonly coincides with ore, that grades outward into an extensive, marginal propylitic alteration halo. These older alteration assemblages can be overprinted by phyllic (sericite+/-pyrite) alteration. Mineralization consists of stockworks of quartz veinlets, quartz veins, closely spaced fractures and breccias containing pyrite and chalcopyrite with lesser molybdenite and bornite; disseminated sulphide minerals are present, but generally in subordinate amounts.

Porphyry copper mineralization at Eaglehead exhibits many similarities to the Plutonic sub-type of porphyry copper deposits in British Columbia.

## 1.6 Drilling and Re-assessment of Historic Drillholes

A comprehensive database has been assembled for the Eaglehead Project that includes information generated by several different exploration companies since 1963. A total of 126 drillholes (36,606m) have been drilled on the Project. Geological logs and analytical certificates are not available for all the drillholes. Most of the drill core is still stored on the property and much of it has been recovered and re-examined. A total of 91% of the assay intervals have been re-logged since 2016.

Not all the historic drillhole cores have been recovered. Drill core for 8 of 14 holes drilled in the Camp zone, 6 of 24 holes drilled in the Pass zone, are not available for review. For the lost drillholes, in some instances historical drill logs are available and, in some cases, the historic drillhole log cannot be located. Where drill core and drill logs are not available, historical exploration reports as well as work completed since 2014 has been used in completing the assessment of the Camp and Pass zones.

Recently employed (2014 - 2023) systematic drillhole logging, core sampling and QAQC procedures follow protocols that are consistent with industry best management practices. Moving forward, a 4-acid digestion with ICP AES/MS for 48 elements and fire assay for gold with atomic absorption spectroscopy will be used for analytical purposes.

The project data (magnetic, radiometric, chargeability, resistivity, geological and analytical) to the end of 2023 has been integrated into updated 3D geological and alteration block models. In additional modeling of the strike and dip of the mineralized envelope where possible has been completed.

### **1.7 Sample Preparation, Security and Analysis**

Sample preparation, security and analytical methods have varied since the first drilling program in 1965. For the most part BQ, NQ and HQ-diameter core has been split or sawn and sampled on 1m to 3m intervals. In some cases, individual pieces of whole core were collected between driller blocks, forming a “representative” sample for a broader interval, and submitted for analysis. Historical sample preparation, sampling procedures, and lab and analytical methods employed by Kennco, Nuspar, Imperial, Esso, and Homestake for geochemical sampling and diamond drill core sampling are not known. Sample preparation, sampling procedures, and lab and analytical methods utilized by Poloni, similarly, are not known. While details are not provided in assessment reports, the writer believes that historic sample preparation and security were conducted in an appropriate manner, following best industry management practices at the time the work was completed, and was conducted by, or under the direction of, experienced field exploration personnel.

From 2006-2008 drill core sampling was conducted by District Copper personnel, but there is no record of written protocols followed. District Copper reported a standard methodology for sampling core and employed Acme Analytical Laboratories Ltd. (ACME) in Vancouver to provide analysis (copper, molybdenum, and silver by aqua regia (HCL-HN03-H2O) digestion methods, and gold by fire assay with ICP-ES finish methods). There is no reference to the use of certified reference material (CRM), duplicates or blanks. There is no reference to the use of a check-assay procedure.

Independent quality control/quality assurance (QAQC) procedures were implemented during the 2011 diamond drilling program. The 2011 procedures, once employed, consisted of the insertion of one CRM every 20 to 25 samples, the insertion of one blank standard every 20 to 25 samples, and the re-sampling of drill core (field duplicate) every 20 to 25 samples. The aqua regia digestion method was used again in 2011 (and for a short time after 2011). Core samples were not analyzed for gold in 2011. There is no reference to the use of a check-assay procedure.

Further improvements were made to the sample preparation, sampling procedures, and analytical methods during the 2014-2015 drilling programs, including the implementation of written protocols; these were also applied to the resampling and analysis of historic drill core in 2016 and 2018. Samples were submitted to SGS and analyzed for a suite of 53 elements using a 4-acid digestion with ICP AES/MS (SGS code GE-ICM40b) and were assayed for gold using fire assay with atomic absorption spectroscopy (SGS code GE\_FAA313). Samples returning values >0.8% Cu or >1% Mo were re-analyzed using ICP90Q, samples returning values >10 ppm Au were re-analyzed using fire assay method FAG303, and samples returning >100 ppm Ag were re-analyzed using fire assay method FAG313 (Stewart, 2016).

The writer concludes that the sample preparation, security, and analytical procedures utilized in recent exploration programs, from 2006 onward, meet or exceed current industry best management practices. Continued use of a comprehensive QAQC program, as suggested by Amec Foster Wheeler (2016) is recommended to ensure that all analytical data can be confirmed to be reliable.

### **1.8 Data Verification**

In 2017 a batch of check assays comprising 24 samples from stored core and pulps, 4 Standard Reference Material (SRM) and 2 blanks was submitted to MS Analytical (MSA) in Langley BC for

analysis. The tests used were Fire Assay with AAS finish for Au, ICP-AES for multi-element testing for all samples to include Cu, Mo and Ag, and 4-acid with ICP-AES for higher grades of Cu. In summary, although the data set is small, the analysis of duplicate pairs shows acceptable precision for Cu, Mo, and Ag. The precision of the Au results is considered fair.

Verification of 2018 analytical results generated by resampling of historic drill core consisted of a review of the new data and of the laboratory analytical certificates.

It is the opinion of the independent QP that, with very few exceptions, all work, procedures, and results have adhered to the best practices and industry standards as required by NI 43-101 and are of sufficient quality to support the mineral resource estimate herein.

## **1.9 Metallurgical Testing**

In 2015 and 2016, SGS Canada Inc. (SGS) conducted a suite of preliminary metallurgical tests on HQ core collected the East and Bornite zones, and on NQ core collected from the Pass zone. The conclusions drawn from the studies were as follows:

- A Master Composite was formed by blending four variability composites forming a feed head grade of 0.2% Cu, 0.024% Mo, 0.18 g/t Au, and 1.3 g/t Ag. The four sub-composites ranged from 0.16 - 0.31% Cu, 0.008-0.05% Mo, 0.07- 0.27 g/t Au and 1 - 1.6 g/t Ag. The master composite and the four sub-composites were subjected to flotation testing. Mineralogical characterization was conducted on the four sub-composites.
- Mineralogical characterization using QEMSCAN was conducted on the four sub-composites, which showed that copper is present predominantly as chalcopyrite in all four samples with significant amounts of bornite in composites 1, 3, and 4. However, copper flotation was not impacted by the presence of bornite.
- BWI testing was performed on 9 samples and the Bond Work Indices varied from 16.9 to 20.6kWh/t with an average BWI of 18.6kWh/t, categorizing the composites as hard and very hard per the SGS database.
- Ai testing was performed on 6 samples and the Bond Abrasion Index ranged from 0.211 g to 0.554 g with an average Ai of 0.381 g. The samples were categorized as medium to abrasive per the SGS database.
- A simple copper/molybdenite rougher-regrind-cleaner flotation flowsheet was employed, and excellent flotation results were achieved from the locked cycle test. The final copper/molybdenite bulk concentrate assayed 29.6% Cu, 2.72% Mo, 28.2 g/t Au, and 175.9 g/t Ag at recoveries of 89.9% copper, 71.1% molybdenite, 78.6% gold, and 78.1% silver.

## **1.10 Conclusions and Recommendations**

A drill program in two Phases is recommended to advance the Eaglehead project with the goal of expanding the resource and upgrading from Inferred to Indicated the existing resource. The estimated cost of the Phase 1 drill program is recommended program is \$1.7 million as summarized in Table 1-2 below. Should the Phase 1 program be successful, additional future drilling is recommended in a Phase 2 program for additional resource expansion and upgrading as summarized in Table 1-3.

**Table 1-2: Proposed Budget for Recommended Exploration Program – Phase 1**

Activity	Cost
Surveying	\$ 30,000
Deposit Modelling, QEMSCAN, Petrology (20 samples)	\$ 31,150
Metallurgical Test Work (approx. 10 @ 10,000/sample)	\$ 100,000
Phase 1 Diamond Drilling (2500m @\$178/m), incl. Pad Building and Road Prep	\$ 454,500
Helicopter Support (Primarily Drill and Camp Support)	\$ 186,800
Personnel (Management, Geologists, Geo-Techs)	\$ 242,800
Field Supplies and Rentals	\$ 63,300
Camp Accommodation & Meals	\$ 38,600
Travel	\$ 41,600
Fuel	\$ 99,700
Assaying (approx. 850 @ \$150/sample (prep and analysis (FA + 4-acid)))	\$ 127,500
QAQC	\$ 25,000
Reporting	\$ 50,000
General Agreements and Archaeology	\$ 74,000
<b>Sub-Total</b>	<b>\$ 1,564,950</b>
Contingency (10%)	\$ 156,495
<b>Total</b>	<b>\$ 1,721,445</b>

**Table 1-3: Proposed Budget for Recommended Exploration Program – Phase 2**

Activity	Cost
Surveying	\$ 45,000
Bedrock Mapping	\$ 15,000
Geophysical Survey	\$ 250,000
Deposit Modelling, QEMSCAN, Petrology (45 samples)	\$ 72,300
Metallurgical Test Work (approx. 25 @ 10,000/sample)	\$ 250,000
Phase 2 Diamond Drilling (5800m @\$178/m), incl. Pad Building and Road Prep	\$ 1,055,000
Helicopter Support (Primarily Drill and Camp Support)	\$ 433,400
Personnel (Management, Geologists, Geo-Techs)	\$ 563,300
Field Supplies and Rentals	\$ 146,900
Camp Accommodation & Meals	\$ 89,600
Travel	\$ 96,500
Fuel	\$ 231,300
Assaying (approx. 1950 @ \$150/sample (prep and analysis (FA + 4-acid)))	\$ 292,500
QAQC	\$ 58,000
Reporting	\$ 116,000
General Agreements and Archaeology	\$ 74,000
<b>Sub-Total</b>	<b>\$ 3,788,800</b>
Contingency (10%)	\$ 378,880
<b>Total</b>	<b>\$ 4,167,680</b>

## 2 Introduction

### 2.1 Purpose of Report and Terms of Reference

Copper Fox Metals Inc. (“Copper Fox”) through its wholly owned subsidiary Northern Fox Copper Inc. (“Northern Fox”) retained Moose Mountain Technical Services (MMTS) to prepare a National Instrument 43-101 (NI 43-101) Technical Report and Mineral Resource Update for the Eaglehead Project. The Project includes a significant calc-alkalic porphyry copper-molybdenum-gold-silver deposit in northwest British Columbia, Canada. The author of the report is Sue Bird M.Sc., P.Eng., of MMTS who is a “Qualified Person” as defined by NI 43-101.

Northern Fox is a private wholly owned subsidiary of Copper Fox a publicly traded Canadian mineral exploration company listed on the TSX-Venture Exchange in Canada (TSX VENTURE: CUU) and in the United States on the OTCQX® Best Market (“OTCQX”) (“CPFXF”). Copper Fox is focused on the acquisition, exploration, and development of copper mineral projects in North America with offices in Calgary, Alberta Canada. Copper Fox’s property portfolio also includes a 100% working interest in the Van Dyke, Mineral Mountain, and Sombrero Butte copper project in Arizona and a 25% working interest in the Schaft Creek Joint Venture with Teck Resources Limited (75%) as Operator.

The purpose of this NI 43-101 Technical Report is to provide an up-to-date compilation of all historic and recent exploration activities and results for the Project. This Technical Report was prepared in accordance with the guidelines provided in NI 43-101, Standards of Disclosure for Mineral Projects (CIM, 2014) for technical reports, Companion Policy 43-101CP, Form 43-101F1, and using industry accepted Canadian Institute of Mining, Metallurgy and Petroleum (CIM) “Best Practices and Reporting Guidelines” for disclosing mineral exploration information, including CIM Definition Standards for Mineral Resources and Mineral Reserves (CIM, 2019).

### 2.2 Sources of Information

This report is based on historical information and data compiled by Copper Fox including unpublished papers and electronic copies of reports, technical memos and correspondence, geologic maps, drill logs and cross-sections, analytical results from re-sampling and sampling stored historic drill core and drill core pulps, analytical results from diamond drilling and re-analyses completed from 1965 to 2022, modelling of current and historical data geophysical surveys, petrology, whole rock analyses, age dating of specific lithologies and publicly available reports and documents. All sources of data referenced in the text are listed alphabetically in Section 27 of this Report.

### 2.3 Site Visits and Scope of Personal Inspections

The Qualified Person (Sue Bird) visited the Project on August 28, 2022. A helicopter tour of the site included flying the existing access road eastward from Dease Lake to Boulder City and northward from Boulder City to the Project. The on-site review included an aerial perspective of the relative locations of each of the mineralized zones. Ground inspections included examination of the camp, core logging and core storage facilities and visits to several historic drillhole collar locations, outcrops, and examining core from holes drilled from 1980 - 2016. Activity on the Project at the time of the visit, included re-logging, sampling, and re-sampling of drill core, mapping and prospecting of potential exploration targets identified by Copper Fox prior to commencement of the field season. A review of active drill core handling, drill core Chain-of-Custody procedures, and QAQC methodologies was also completed.

### **3 Reliance on Other Experts**

This report has been prepared by Sue Bird, M.Sc., P.Eng. (the QP) for Copper Fox Metals Inc. and its wholly owned subsidiary Northern Fox Copper Inc. The information, conclusions, and opinions contained herein are based on:

- Information available to the QP at the time of preparation of this report,
- Assumptions, conditions, and qualifications as set forth in this report, and
- Data, reports, and other information supplied by Copper Fox and other third-party sources.

For the purpose of this report, the QP has relied on ownership information provided by Copper Fox. The QP has not researched property title or mineral rights for the Eaglehead Project and expresses no opinion as to the ownership status of the property.

## **4 Property Description and Location**

### **4.1 Location and Description**

The Eaglehead Project is located approximately 50km east of the small community of Dease Lake in the Cassiar region of northwest British Columbia (Figure 4-1). The project lies within the Cry Lake map area and covers parts of five British Columbia Geological Survey (BCGS) 1:20,000 scale map sheets: 104I-045, 104I-046, 104I-054, 104I-055, and 104I-056. The Project is centered approximately at Universal Transverse Mercator (UTM) coordinates (NAD 83, Zone 9) of 495804m East and 6481505m North or 58° 28' 27" north latitude and 129° 4' 19" west longitude.

The Project tenure follows a U-shaped glacial valley situated between two mountain ranges that in part comprise the Stikine Ranges of the Cassiar Mountains. The main areas of interest follow a northwesterly trend and lie southeast of Eaglehead Lake and northwest of the Turnagain River.

The Project encompasses six principal zones of porphyry copper-molybdenum-gold-silver mineralization none of which outcrop, except the Camp zone. From southeast to northwest, they are the Far East, East, Bornite, Pass, Camp and West zones. A NI 43-101 Resource Estimate was determined for the East and Bornite zones in 2012 (McDonough and Rennie, 2012). Since that time significant additional drilling, preliminary rock characterization studies, re-logging and re-sampling of historical diamond drill core, re-analyse of drill core pulp samples, ground and airborne geophysical surveys, reconnaissance mapping, age dating, petrographic studies and whole rock analyses has added important information to the dataset for the Project.

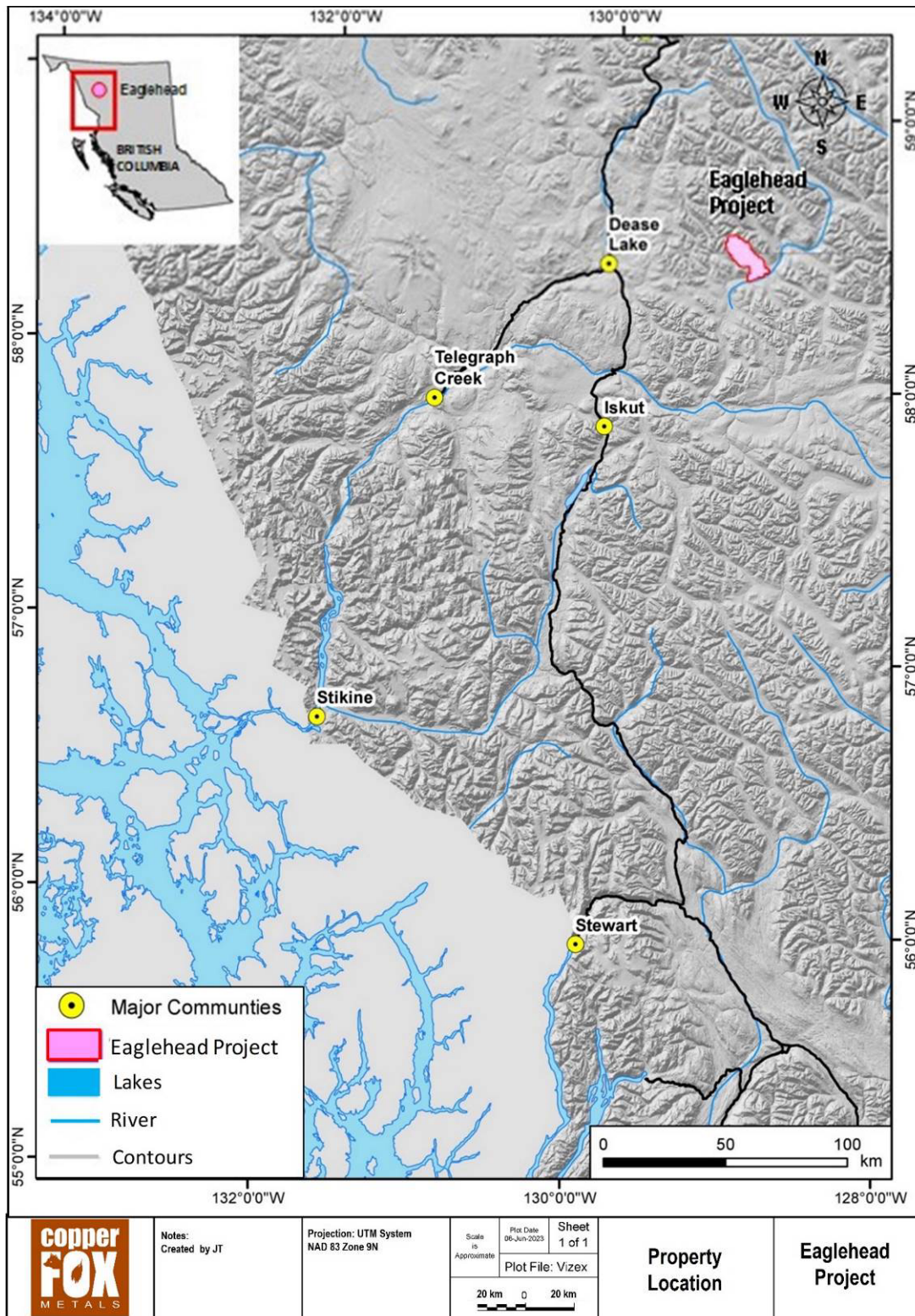
### **4.2 Tenure and Ownership**

#### **4.2.1 Tenure**

The Ministry of Energy, Mines and Low Carbon Innovation is largely responsible for the mining sector. The Ministry of Environment and Climate Change Strategy, the Environmental Assessment Office and the Ministry of Forests, Lands, Natural Resource Operations and Rural Development provide for additional oversight of mining operations through their respective mandates. Applicable legislation and regulation in British Columbia include:

- Mineral Tenure Act (MTA);
- Land Act;
- Mines Act (and the accompanying Health, Safety and Reclamation Code for Mines in British Columbia);
- Mineral Land Tax Act;
- Mineral Tax Act;
- Environmental Assessment Act;
- Environmental Management Act.





**Figure 4-1: Eaglehead Project Location Map**

Rights to mineral resources on public lands are generally held by the Crown. The ownership of lands and minerals situated in a province generally belong to the province. The provincial government exercises administration and control of ownership and disposition of most mining rights and lands through provincial legislation. The Eaglehead project is comprised of 11 contiguous mineral tenures

that in total cover 15,712.8 hectares (157.2 km<sup>2</sup>) of land in the Liard Mining Division (Figure 4-2; Table 4-1). The claims area registered as 100%-owned by Northern Fox in the British Columbia government's Mineral Titles Online titles management system.

District Copper Corp holds a general security on the Eaglehead project subject to receipt of the final debenture payment of \$330,000 due on April 17, 2024. Copper Fox has guaranteed the debenture payments owing by Northern Fox. The project does not include any surface tenure. The project is not encumbered by any National or Provincial parks, or by any other type of protected area.

**Table 4-1: Eaglehead Mineral Claim Summary**

<b>Title Number</b>	<b>Claim Name</b>	<b>Owner</b>	<b>Title Type</b>	<b>Title Sub Type</b>	<b>Map Number</b>	<b>Issue Date</b>	<b>Good To Date</b>	<b>Status</b>	<b>Area (ha)</b>
409960	EH #9	286917 (100%)	Mineral	Claim	104I045	2004/APR/17	2025/APR/30	GOOD	100.00
528788	T6	286917 (100%)	Mineral	Claim	104I	2006/FEB/23	2027/MAY/01	GOOD	270.22
528789	T7	286917 (100%)	Mineral	Claim	104I	2006/FEB/23	2027/MAY/01	GOOD	422.47
528790	T8	286917 (100%)	Mineral	Claim	104I	2006/FEB/23	2028/MAY/01	GOOD	253.61
1056997	EAGLE100	286917 (100%)	Mineral	Claim	104I	2017/DEC/12	2025/APR/30	GOOD	1030.05
1056998	EAGLE101	286917 (100%)	Mineral	Claim	104I	2017/DEC/12	2025/APR/30	GOOD	844.35
1056999	EAGLE102	286917 (100%)	Mineral	Claim	104I	2017/DEC/12	2025/APR/30	GOOD	270.90
1057000	EAGLE103	286917 (100%)	Mineral	Claim	104I	2017/DEC/12	2025/APR/30	GOOD	271.18
1082809	Eaglehead	286917 (100%)	Mineral	Claim	104I	2015/MAR/06	2025/APR/30	GOOD	11286.18
1083275		286917 (100%)	Mineral	Claim	104I	2005/APR/25	2027/MAY/01	GOOD	270.27
1083277		286917 (100%)	Mineral	Claim	104I	2005/APR/20	2029/DEC/01	GOOD	693.70

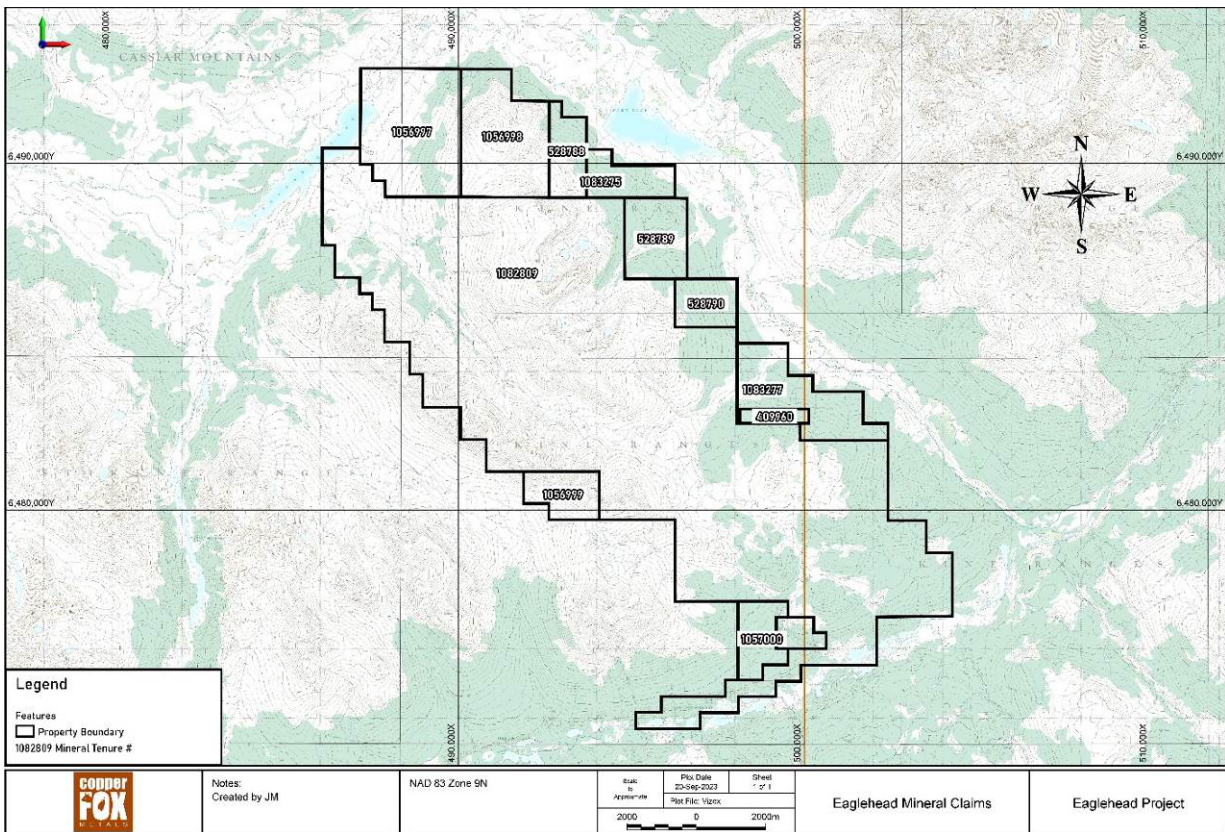


Figure 4-2: Mineral Tenure Map, Eaglehead project

#### 4.2.2 Ownership

Copper Fox through its wholly owned subsidiary Norther Fox owns 100% working interest in the Eaglehead Project and 3,328,326 (15.6%) of the issued and outstanding shares of District Copper (Copper Fox interim financial statements, April 30, 2023).

District Copper acquired ownership of the Eaglehead project by way of an option agreement with then owners John Poloni and Ernest S. Peters (the Optionors) whereby District Copper had an option to earn 100% in the Project. Under the terms of the agreement, District Copper was required to pay an aggregate sum of C\$350,000 and issue a total of three million shares of the company to the Optionors over five years. In addition, District Copper was required to fund C\$6 million in exploration expenditures over six years and grant the Optionors a 2.5% Net Smelter Return (NSR) royalty on future production, of which 1.5% may be purchased for a C\$2 million cash payment. The conditions set out in the agreement were met in 2011 resulting in District Copper controlling 100% of the Project subject to the NSR (District Copper news release, August 23, 2011).

During the year ended July 31, 2014, District Copper acquired an additional four claims comprising 2,130 hectares for \$11,011 from Copper Fox. Three of the four additional claims, comprising of 981 hectares, were acquired from Copper Fox and are subject to an arm's length third party 2% NSR, one-half (1%) of which may be purchased for \$1,000,000.

In March 2015, District Copper amalgamated all mineral tenures making up the Eaglehead Project into one mineral tenure covering approximately 13,539.6 hectares.

On May 8, 2018, District Copper acquired four additional mineral tenures (2,416.5 hectares) contiguous to its 100% owned Eaglehead Project for \$15,000 and 3,900,000 shares. The vendor

retains a 2% Net Milling Returns Royalty (“NMRR”) on production from the four claims, with District Copper retaining the right to re-purchase 1.5% of the 2% NSR for \$1,000,000.

On April 19, 2021, Copper Fox through its wholly owned subsidiary Northern Fox Copper Inc. completed the purchase of the Eaglehead copper project for an aggregate consideration of CAD\$1.20 million. A sum of \$200,000 was paid at closing and the remaining CAD\$1 million is to be paid in three annual installments of \$340,000, \$330,000, and \$330,000 on each anniversary following closing. The final payment of \$330,000 is payable on April 15, 2024. The Vendor retained a 0.5% net smelter return royalty over the Eaglehead Property, half of which can be purchased by Northern Fox for \$1,000,000 at any time up until the second anniversary of commercial production on the Eaglehead Property. The Promissory Note covering the three annual installments is secured by a general security agreement and is registered against Northern Fox Copper’s assets.

On February 1, 2022, Northern Fox completed a mineral tenure exchange with Giga Metals Corporation consisting of exchanging one mineral tenure (2,153.4 ha) located on the southeast end of the Eaglehead project for five mineral tenures (totaling 1,910.3 ha) located along the northern border of the project.

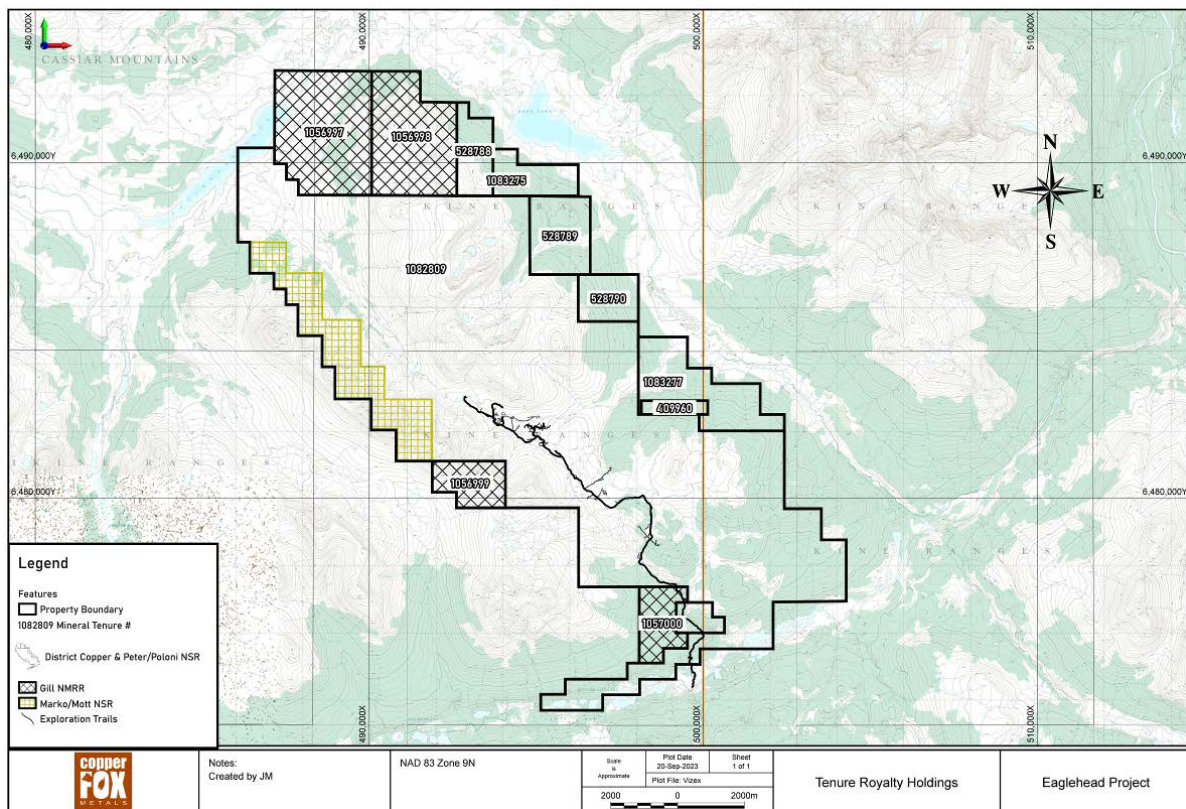
On July 26, 2022, Northern Fox added mineral tenures 1096809 and 1096808 to the Eaglehead project to secure locations for potential future infrastructure locations.

On July 26, 2023, Northern Fox voluntarily allowed mineral tenures 1096808 and 1096809 to expire as these tenures are not considered important for future project infrastructure development.

The schedule of Net Smelter Return (‘NSR’) and one Net Milling Returns Royalty (‘NMRR’) agreements applicable to the Eaglehead project is set out in Table 4-2 and shown on Figure 4-3.

**Table 4-2: Terms and Conditions of Royalty tied to Mineral Tenures, Eaglehead Project**

NSR/NMRR Party	Title Number	Claim Name	NTS Map Number	Owner	Area (ha)	Description	NSR/NMRR %	NSR/NMRR Buyback %	NSR/NMRR Buyback \$
<b>Peters/Poloni</b>	409960	EH #9	1041045, 046	286917 (100%)	100	Net Smelter Return (NSR) Includes a 5.0 km area of interest clause.	2.5	1.5	\$2,000,000
	528788	T6	1041055	286917 (100%)	270.22				
	528789	T7	1041055	286917 (100%)	422.475				
	528790	T8	1041055	286917 (100%)	253.607				
	1056997	EAGLE100	1041054, 055	286917 (100%)	1030.05				
	1056998	EAGLE101	1041055	286917 (100%)	844.35				
	1056999	EAGLE102	1041045	286917 (100%)	270.9				
	1057000	EAGLE103	1041045	286917 (100%)	271.18				
	1082809	Eaglehead	1041045, 046, 054, 055	286917 (100%)	11286.18				
	1083275		1041055	286917 (100%)	270.2653				
	1083277		1041045, 046	286917 (100%)	693.6968				
	1096808	EAGLE 104	1041045, 046	286917 (100%)	118.6371				
	1096809	EAGLE 105	1041045	286917 (100%)	661.0685				
	<b>District Copper</b>	409960	EH #9	1041045, 046	286917 (100%)				
528788		T6	1041055	286917 (100%)	270.22				
528789		T7	1041055	286917 (100%)	422.475				
528790		T8	1041055	286917 (100%)	253.607				
1056997		EAGLE100	1041054, 055	286917 (100%)	1030.05				
1056998		EAGLE101	1041055	286917 (100%)	844.35				
1056999		EAGLE102	1041045	286917 (100%)	270.9				
1057000		EAGLE103	1041045	286917 (100%)	271.18				
<b>Amandeep Gill</b>	1082809	Eaglehead	1041045, 046, 054, 055	286917 (100%)	11286.18	Net Milling Returns Royalty (NMRR)	2	1.5	\$1,000,000
	1083275		1041055	286917 (100%)	270.2653				
	1083277		1041045, 046	286917 (100%)	693.6968				
	1056997	EAGLE100	1041054, 055	286917 (100%)	1030.05				
	1056998	EAGLE101	1041055	286917 (100%)	844.35				
<b>Marko/Mott</b>	1056999	EAGLE102	1041045	286917 (100%)	270.9	Pre-amalgamation of 1082809, thus only claims 102746, 1027655, 1027656 (comprised of 980.99 ha) apply to this NSR.	2	1	\$1,000,000
	1057000	EAGLE103	1041045	286917 (100%)	271.18				



**Figure 4-3: Tenure Royalty Holdings – Eaglehead Project**

### 4.3 Historical Ownership Dispute

On April 12, 2016, District Copper received notification that its Eaglehead claim had been forfeited under the British Columbia Mineral Tenure Act and deleted from the Registry for failure to file work or pay cash in lieu of assessment work to maintain the claim in good standing. The circumstances giving rise to the forfeiture involved a filing made by District Copper in March 2015, to amalgamate all the mineral claims that comprise the Eaglehead Project into one mineral claim (1034634). The expiry date for the new amalgamated claim became the earliest expiry date of any of the claims being amalgamated (e.g., April 11, 2016) even though the majority (30 of the 34) of the claims being amalgamated were in good standing until 2019. Following April 11, 2016, intervening parties staked claims over the allegedly forfeited amalgamated tenure. District Copper subsequently requested the Chief Gold Commissioner (the “CGC”) for the Province of British Columbia to set aside the April 11, 2016, forfeiture of mineral claim 1034634 pursuant to the Chief Gold Commissioner’s authority under Section 67 of the Mineral Tenure Act and allow a further period to comply with Section 29 of the Act. On April 22, 2017, District Copper received a written decision from the CGC to reinstate the District mineral claim and allowed District Copper until September 30, 2016, to comply with Section 29 of the Act. District Copper complied with the requirements of the extension by filing an assessment report on September 8, 2016.

In his decision to reinstate the District Copper tenure, the CGC considered the long-standing claim history and development, the significant exploration expenditure, the extraordinary prejudice to District Copper compared to the relatively minor impacts to the intervening claim holders, and the inadvertent nature of the District Copper administrative error. In conjunction with the decision to reinstate the District Copper claim, the Chief Gold Commissioner determined that all new claims registered over the area of the District Copper claim were to be treated as intervening claims and were cancelled from the registry.

However, on June 14, 2016, the intervening parties filed a Petition in the Supreme Court of British Columbia against the CGC requesting a judicial review of his decision to reinstate the District Copper claim. The judicial review was heard in the Supreme Court of British Columbia on January 24, 2017.

On July 17, 2017, the Supreme Court of British Columbia issued an oral judgment that the Petitioner's challenge of the Gold Commissioner's decision to reinstate District Copper's claim #1034634 be dismissed. The presiding justice found that there was no lack of procedural fairness, transparency, or rigour in the decision of the Gold Commissioner, as alleged by the Petitioner's and as such the judge saw no conflict between the Commissioner's interpretation of his authority under the Mineral Tenure Act and prior case law.

On August 23, 2017, District Copper announced that the petitioners challenging the Company's title to the Eaglehead claims had not filed a Notice of Appeal related to the decision of the Supreme Court of British Columbia delivered on July 17, 2017, within the time permitted by court rules, and that District Copper was the 100%-ownership of the Eaglehead Project.

#### **4.4 Community and Local Relations**

The Project overlaps traditional lands of the Tahltan First Nation (TFN). On January 1, 2021, Copper Fox on behalf of Northern Fox entered into a Communication and Engagement agreement with the Tahltan Central Government pertaining to the Eaglehead Project. The Communication and Engagement agreement is automatically renewed on an annual basis unless cancelled by one of the parties based on 30 days notice to the other party. In addition to facilitating continuing discussions and presentations, the agreement provides for, among other things, sponsorship, and employment opportunities as well.

On August 23, 2022, Copper Fox on behalf of Northern Fox forwarded an executed copy of an Exploration Agreement with the Tahltan Central Government pertaining to the Eaglehead project to support constructive engagement of the TCG in the Exploration Program and to ensure the TCG can meaningfully review, collaborate, monitor, and consent to all aspects of the Exploration Program and participate in the economic benefits arising from the Exploration Program.

The writer is not aware of any other encumbrances, or potential encumbrances, that would negatively impact the future exploration of the Project.

#### **4.5 Permitting, Environmental Liabilities and Other Issues**

Exploration on the Eaglehead Project is currently approved by the British Columbia Ministry of Energy and Mines (BCMEM) under Permit Number: MX-100000008 Mine Number: 0101121, issued to Northern Fox on November 7, 2022. Pursuant to the Permit drilling operations from two sites had been approved until March 31, 2024. Copper Fox posted a reclamation bond totaling \$212,000 to provide funding for reclamation of all disturbances related to exploration conducted on the Project. The funds are held by the Minister of Finance and only will only be released to the Northern Fox upon reclamation of the Project as deemed satisfactory by a Mines Inspector from the BCMEM. Water for use in diamond drilling activities is included within the Permit granted on November 7, 2022. Expansion of the drilling program would require an application pursuant to the "Water Use for Mineral Exploration and Small-Scale Placer Mining under the *Water Sustainability Act*" which was updated in April 2016. Northern Fox has adopted the Draft Exploration Road Management Plan prepared by Greenwood Environmental Inc. on behalf of District Copper in 2016.

In 2021 Northern Fox posted a reclamation bond totaling C\$212,000 to provide funding for reclamation of all disturbances related to exploration conducted on the Project. The funds are held

under Permit Number: MX-100000008 by the Minister of Finance; and will only be released to the company upon reclamation of the Project as deemed satisfactory by a Mines Inspector from the BCMEM.

In November 2016, District Copper submitted a “Draft Exploration Road Management Plan” for *Mines Act* Permit MX-1-661 to the BCMEM. The Draft Exploration Road Management Plan was prepared by Greenwood Environmental Inc. The objective of this plan was to describe measures for protecting streams, lakes, and wetlands by following appropriate methods for construction and operation of roads/trails throughout the Project area. Access for exploration is directed in part by Section 9.10.1 of the Health, Safety, and Reclamation Code (HSRC) of the *Mines Act* with practical guidance in Section 10 of the Handbook for Mineral and Coal Exploration in British Columbia (HME). As required by Sections 9.10.1 (1) and (5) of the HSRC, the Exploration Road Management Plan describes the methods for monitoring and maintenance of the access roads/trails with particular emphasis on drainage control, erosion prevention, and sediment control. Northern Fox has accepted this Road Management Plan and plans to implement its objectives going forward.

There are no known environmental liabilities associated with the Project because of any previous exploration. Northern Fox is required to file an Annual Summary of Exploration Activities (ASEA) with BCMEM. All filings are currently up-to-date.



## **5 Accessibility, Climate, Local Resources, Infrastructure and Physiography**

### **5.1 Access**

The Eaglehead project is located approximately 50 kilometers east of the community of Dease Lake in northern British Columbia, Canada. Access to the Project is primarily via helicopter. Tundra Helicopters and Aberdeen Helicopters operate seasonal helicopter bases at Dease Lake and have been used during summer programs to transport staff, supplies and samples to and from the site.

Access to the Eaglehead Project can also be gained by using the Caribou Pass Road eastward from Dease Lake to Boulder City and then northward to the Project. A Delta (a large off-road vehicle), located in Boulder City can be used to pick up supplies in Dease Lake and transport them to the Project. The Caribou Pass Road is managed by the Boulder Trail Users Association (“BTUA”) pursuant to a Special Use Permit #26726 issued by the Ministry of Forest, Lands, Natural Resources, Operations and Rural Development dated September 8, 2020. Northern Fox is not a member of the BTUA. To utilize the Caribou Pass Road to transport supplies to the Eaglehead project, Northern Fox would be required to become a member of the BTUA, which has an annual membership fee of \$6,000.00.

Dease Lake was serviced by a charter flight operated by NT Air from either Smithers or Terrace with flights scheduled for Monday, Wednesday, and Fridays. Regular commercial flights operated by Air Canada and Central Mountain Air fly from Smithers and Terrace to various regional hubs in British Columbia. These scheduled flights to Dease Lake were suspended in 2017. The suspension of scheduled flights to Dease Lake is still in effect as of the date of this report.

### **5.2 Climate**

The project area lies in a region of moderate annual precipitation with an average of 530 mm total annual precipitation which is more or less evenly distributed throughout the year, with April to May receiving the least and August to December the most. Temperatures vary from an average low of -20o C in January to an average high of 10o C in July with temperature extremes ranging from -50o C to 30o C. Summer exploration programs normally span the period from late May to mid-September depending on snow conditions. Winterization of the camp could allow exploration activities to be conducted all year around.

### **5.3 Local Resources**

Northwest British Columbia has a history of mining activity. Supplies and trained labour are available from the towns of Smithers, Terrace, Dease Lake, Iskut and Telegraph Creek. The area is well serviced by helicopter and fixed wing charter airlines and experienced labour can be brought in from other parts of the province. Local experienced and general labour is available from the small communities of Dease Lake, Telegraph Creek, Iskut, and Stewart. Diamond drilling equipment is available locally from Smithers or Watson Lake, Yukon, as well as from other centres in British Columbia such as Prince George and Kamloops. The Tahltan Nation Development Corporation (“TNDC”), located in Dease Lake have recently significantly expanded their service base to include diamond drilling, camp logistics, geotechnical personnel, and temporary workers as well.

There is abundant water available for exploration activities and for camp use.

### **5.4 Infrastructure**

The Eaglehead project is located approximately 50 kilometers east of Dease Lake in northern British Columbia. There is no infrastructure on the Project. Electric power is provided by diesel generators and the camp comprises temporary kitchen, shop, wash house, sleeping facilities and core processing

and storage facilities (Figure 5-1). The camp infrastructure in relation to the mineralized zones is shown in Figure 5-2.

Important infrastructure for the Project area is the recently completed 287 kV Northwest Transmission Line to Bob Quinn Lake. This hydro-electrical line provides power for the Imperial Metals' Red Chris mine and communities in this part of British Columbia. Future mining operations in this area of British Columbia could obtain power from this line through BC Hydro.

The closest community, Dease Lake, has electric power, internet service, health facilities, and some road building equipment but lacks cellular telephone service. In 2017, previously scheduled air service between Dease Lake and Smithers, and between Dease Lake and Terrace via Northern Thunderbird Air Inc. (NT Air) was suspended. Smithers and Terrace have daily air service to Vancouver, British Columbia, via Air Canada Jazz and Hawkair Aviation Services Ltd.



**Figure 5-1: Core Storage (lower left) and Camp (lower right), Eaglehead Project**



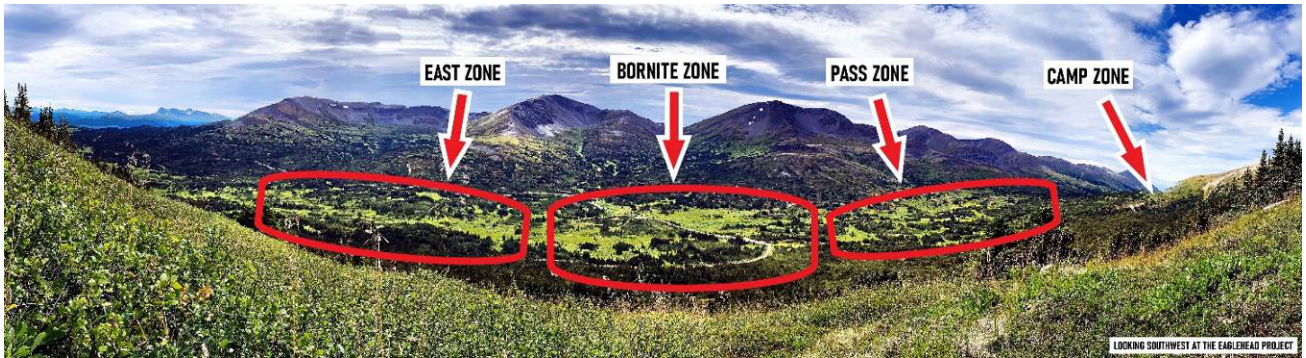
**Figure 5-2: Looking Southward Over the Central Part of the Eaglehead Project**

## **5.5 Physiography and Vegetation**

The Project is situated in a geographic area referred to as the Cassiar Mountains. The property occupies a northwesterly trending, drift-filled valley flanked by northwest-southeast trending ridges. The ridges, with elevations reaching over 1900 m, are typically scalloped on their northeast sides and are gently sloping and rounded on their southern sides. The valley floor is at an approximate elevation of between 1400-1500m asl and is extensively drift covered in which kames, kettles and eskers are prominent features.

Vegetation on the Project is predominantly "bunch grass" and "buck brush" in the valleys with a fringe of scrub alpine spruce and balsam on the lower slopes of the ridges. The upper slopes are covered with bunch grass.

Exposures of bedrock in the valley are restricted to creek beds. The rounded south-facing slopes display few outcrops although talus fans suggest sub outcrops are present. Bedrock outcrops increase in frequency along ridge crests and on the more rugged northeast-facing slopes (Figure 5-3).



**Figure 5-3: Physiography of Mineralized zones Eaglehead project**

## 6 History

Exploration of the Eaglehead Project took place in three main phases, from discovery in 1963 to 1965, from 1970 to 1982, and from 2005 to 2018. In 2021 Northern Fox commenced exploration of the project and conducted exploration program in 2021 and 2022.

Exploration activity on the Project began in 1963 when Kennco Explorations Ltd. (Kennco) staked the Joy 1-32 claims to cover “scattered showings of copper mineralization” it had discovered in association with a geochemical anomaly (BC Minister of Mines Annual Report, 1963). From 1963 to 1965, Kennco conducted geological mapping, geochemical surveys and trenching, and airborne and ground geophysical surveys and completed four diamond drillholes totaling approximately 450.0m (BC Minister of Mines Annual Report, 1963; 1964 and 1965; Panteleyev, 1964; Ahlborn and MacLean, 1971).

The work by Kennco identified several copper mineralized outcrops in the Camp zone and outlined two copper soil geochemical anomalies that extended over 6,000 feet. The Induced Polarization (IP) survey outlined a chargeability anomaly that followed the intrusive/sedimentary rock contact, and Kennco tested the anomaly with four drillholes (two at each end of the property). One drillhole is reported to have intersected 0.4% copper over an interval of 40 feet and a second drillhole is reported to have intersected 0.5% to 0.6% copper over a core interval of 100 feet (Ahlborn and MacLean, 1971). Note that neither specific information for the drilling results nor accurate drillhole locations are known. The claims were eventually forfeited.

In 1970, Spartan Exploration Ltd. (Spartan) later reorganized as Nuspar Resources Ltd. (Nuspar), staked the property (referred to as the Eagle Group), established an exploration grid, and conducted an IP survey. The results of the survey generally confirmed the IP work previously completed by Kennco.

From 1971 to 1976 the ground was optioned to Imperial Oil Limited (Imperial), predecessor to Esso Minerals Canada Ltd. (Esso). Imperial conducted geological, geochemical, and geophysical work and drilled 30 BQ-diameter core holes with an aggregate length of 5,609.0m in the Camp, Pass and Bornite zones (Scott, 1980; Agnerian, 2010). The number of core samples collected by Imperial is unknown. Imperial’s work included sampling of 13 mineralized shear zones that yielded copper values ranging from 0.04 - 6.9% and the discovery of a number of new mineralized occurrences located north of Murmuring creek. Soil sampling over an area measuring 13,400' x 3,500' outlined two large zones of anomalous copper and molybdenum concentrations. One of the anomalous copper zones continued to the northeast into an un-sampled area. Imperial’s IP survey showed the presence of a large anomalous area, roughly coincident with one of the soil anomalies. The drilling tested a number of selected IP targets and intersected copper-molybdenum mineralization in altered intrusive rocks over significant core intervals in the Camp, Pass and Bornite zones.

The Project was dormant until 1979 when Nuspar became the operator and conducted geochemical, and IP geophysical surveys (Burton and Walcott, 1979) and cored five BQ diamond drillholes with an aggregate length of 877.3m. A total of 99 core samples were collected (Ikona and Scott, 1981).

From 1980 to 1982, geochemical sampling, airborne Very Low Frequency Electro-Magnetic (VLF-EM) and magnetometer surveys, ground IP surveys, and drilling of 20 BQ-diameter core holes with an aggregate length of 5,307.0m were completed on the Pass, Bornite, East and West zones. A total of 980 core samples were collected (Ikona and Scott, 1981; Ikona and Scott 1982; Agnerian, 2010). Soil sampling (813 samples analyzed for Cu, Mo, Ag and/or Pb, Zn and Au) on previously untested portions of the property outlined a significant geochemical target on the northern portion of the East grid as

well as a significant target in the western portion of the property. The IP surveys (13.9 total line-km) delineated extensions of the Bornite and East zones that coincided with the geochemical anomalies on the East grid. The diamond drilling indicated that mineralization in the Bornite zone may be controlled by closely-spaced, subparallel sheet-like structures and that the width and grades appear to increase with depth and toward the southwest. The two drillholes completed on the East zone tested an IP anomaly and intersected significant copper-molybdenum mineralization in altered intrusive rocks. The two drillholes completed on the West zone tested an IP target and intersected silicified strongly deformed rocks that contained minor concentrations of copper.

In 1982, Esso resumed operatorship of the Project and conducted geochemical, geological, and geophysical (IP) surveys on the Far East zone and re-evaluated the Bornite zone (Everett, 1982). Four areas of weakly anomalous chargeability were delineated that were interpreted to be extensions of sulphide bearing horizons. The soil sampling survey outlined an extensive copper and molybdenum geochemical anomaly, but its source was not determined.

In 1989 Homestake Canada Inc. (Homestake) acquired Esso's interest in the property and completed work in 1990 and 1992 that consisted of limited grid-based soil geochemical sampling designed to evaluate the potential for shear-hosted gold and silver mineralization associated with the fault contact (terrane boundary) between the Eaglehead pluton and the Kutcho Assemblage. A total of 72 soil samples were collected from 3.4-line kilometres of grid. Results showed that anomalous gold and silver values correlate well with copper values and occur predominantly within areas underlain by intrusive rocks of the Eaglehead pluton. Homestake concluded that the gold-silver anomalies trended to the southeast and warranted investigation (McPherson, 1991; 1993). No other work was done, and the claims were allowed to lapse in 2001.

In 2002, J. Poloni staked the open ground covering the Project. Over the next four years (2002 – 2005) Poloni, with partner E. Peters, established a control grid and conducted rock and soil geochemical sampling, and examined and resampled existing drill cores (Poloni, 2002; Poloni, 2004; Ikona, 2004). In 2005, they contracted S.J. Geophysics Ltd. to complete a 3D IP survey over a total of 25.4 line-km on two grids that covered the Bornite zone and a small part of the Far East zone. Two chargeability anomalies were identified on the Bornite grid, and one chargeability anomaly was located on the Far East grid. The soil sampling program (173 samples analyzed for copper-molybdenum-gold) extended the soil geochemical anomaly in the East zone approximately 1.4km to the east and the IP survey outlined the previously identified conductive zones over the Bornite, East and Far East zones with better detail.

A summary of the work completed on the Project from inception up to and including year 2005 was:

- collection of more than 2,500 soil geochemical samples that outlined a semi-continuous, northwest-trending > 60 ppm copper anomaly with intermittent > 10 ppm molybdenum anomalies over an approximate 10km strike (Figure 6-1; Ikona, 2004)
- more than 75 line-km of airborne magnetic and electromagnetic (EM) surveys
- ground geophysical surveys consisting of:
  - 78 line-km of induced polarization (IP) surveys that outlined a northwest-trending chargeability anomaly coincident with the copper soil geochemical anomaly (Walcott, 1972).
  - 30 line-km of magnetometer and EM surveys that did not detect any discernible conductors.
- A total of 59 diamond drillholes with an aggregate length of 12,243.4m that encountered significant mineralization ranging from 0.1% Cu over 1.5m to 0.452% Cu over 152.7m

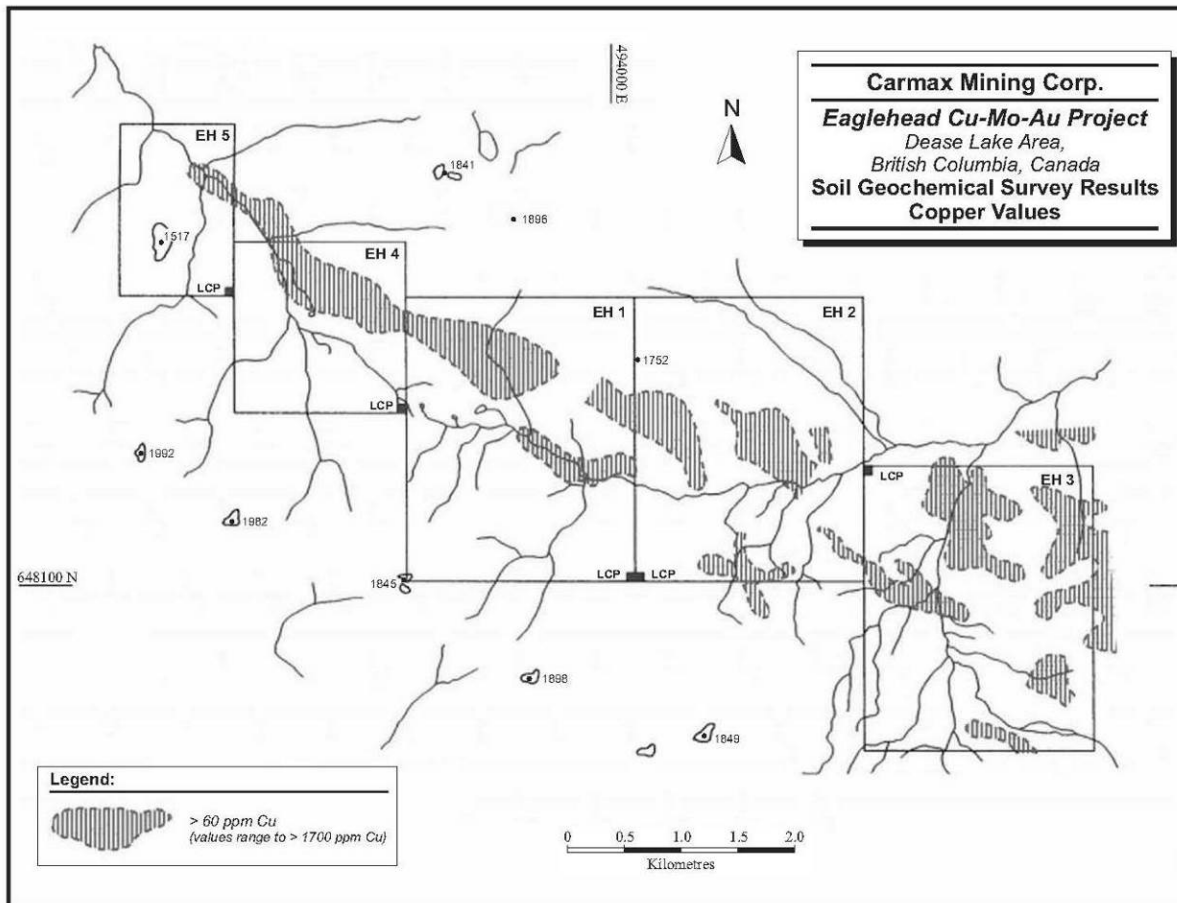
(Agerian, 2010). For a summary of selected drill intersections refer to Section 7.3.3 “Descriptions of Mineralized Zones”.

In November 2005 the Project was optioned to District Copper.

In 2006, District Copper constructed and/or refurbished of 16km of road access from the Turnagain River to the Project and initiated a systematic exploration program to re-evaluate all previously identified mineralized zones and possible extensions to them. In that year, ten NQ diamond drillholes totaling 3,050.3m (553 core samples were collected for analysis) tested the Bornite (1 hole), East (5 holes) and Far East (4 holes) zones which had been outlined in the 3D IP survey completed in 2005. All drillholes intersected significant copper-molybdenum-gold-silver (Cu-Mo-Au-Ag) mineralization and indicated that further drilling, and geochemical and geophysical surveys were needed to evaluate each zone more adequately, particularly the East and Far East zones (Poloni, 2006). Only select intervals of the core were sampled for analysis, presumably being limited to visually well-mineralized and/or strongly altered rock. The lack of continuous sampling left gaps in the analytical dataset for each hole was rectified by later sampling of un-split core intervals (Quist, 2015; Stewart, 2016).

The 2007 exploration program was designed to further explore the East, Bornite and Far East zones. A new 3D IP survey totaling 43.8 line-km was completed over expanded grids that more adequately covered the three zones. Soil geochemical sampling was completed over previously unsampled portions of the grid. Twelve NQ diamond drillholes totaling 4,101.0m (approximately 1,560 core samples were collected for analysis) were also completed during the program; two holes tested the Bornite zone, seven evaluated the East zone, and two evaluated the Far East zone (Poloni, 2008a). All holes drilled in the Bornite and East zones intersected significant intervals Cu-Mo-Au-Ag mineralization.

In 2008, District Copper continued its work on the Project by completing improvements to the access road and camp, conducting a small soil geochemical survey, and completing 5,495.3m (approximately 2,170 core samples were collected for analysis) of NQ diamond drilling in 14 holes (Poloni, 2008b). Holes 082-089, 092 and 094 were drilled in the East zone area, holes 090 and 091 were drilled to assess an undrilled gap between the East and Bornite zones, and hole 095 was drilled to test a 2007 3D IP anomaly in the Far East zone (Poloni, 2008b).



**Figure 6-1: Northwest Trending Copper Soil Geochemical Anomaly, Eaglehead Project (after Ikona, 2004b)**

In 2011, District Copper completed 25 NQ drillholes totaling 8,302.1m (approximately 7,380 core samples were collected for analysis) on the Bornite and East zones and retained Rosco Postle Associates Inc. (RPA) to author a National Instrument 43-101 technical report and mineral resource estimate for the Project (McDonough and Rennie, 2012). Fourteen holes, 096-109, were drilled on the East zone and eleven holes were drilled on the Bornite zone. These holes were primarily drilled to fill in gaps in previous drilling or served as modest step-outs or step downs on each of the two zones. Findings of the mineral resource estimate are discussed below.

In 2012, RPA completed its NI 43-101 resource estimate for the Project. The results of the mineral resource estimate are discussed in Section 14 of this report.

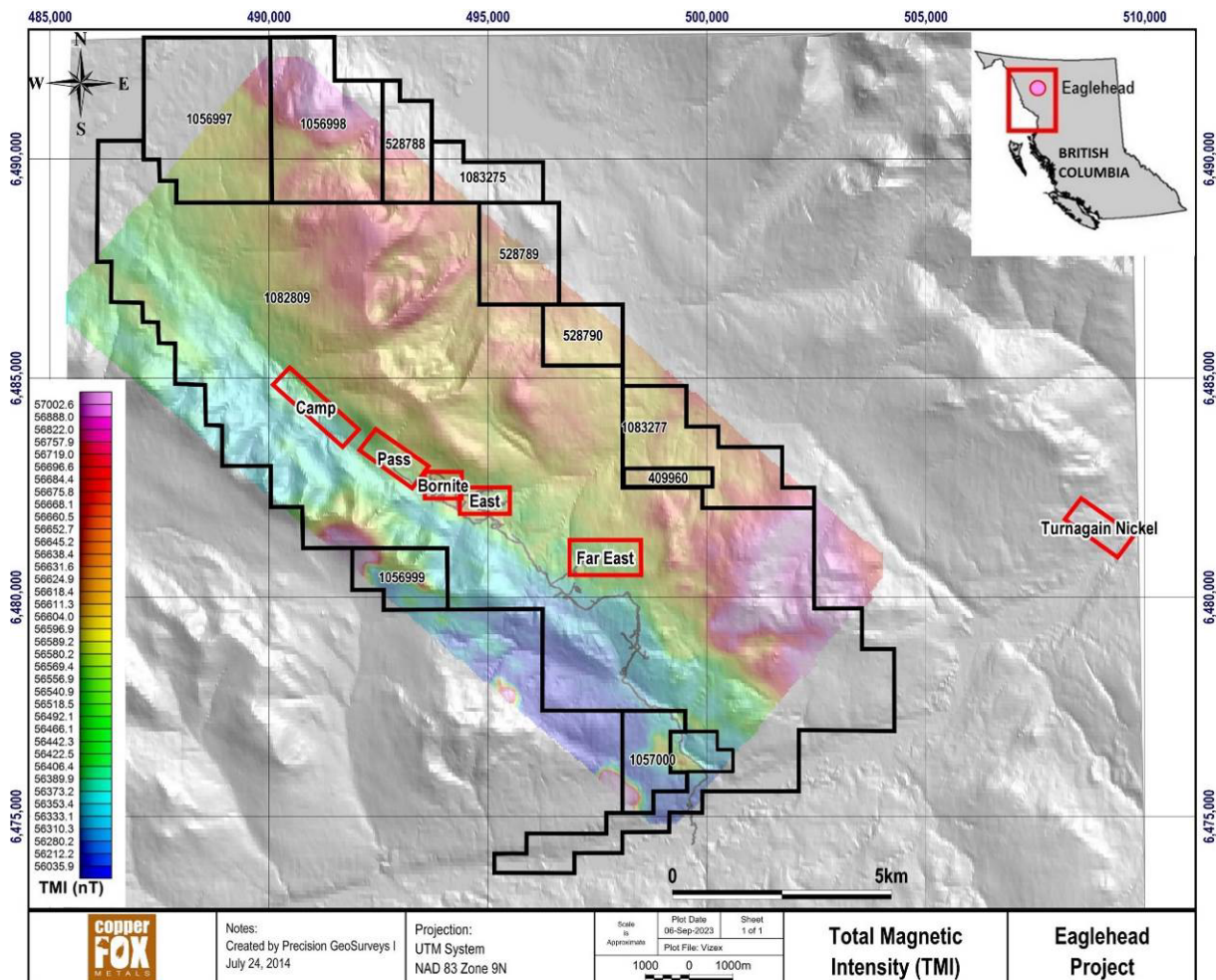
In 2014, with funding by way of a private placement, program planning and onsite direct project supervision provided by Copper Fox, District Copper resumed its exploration efforts at Eaglehead. In the period from 2014 to 2018, Copper Fox provided funding, program planning and onsite direct project supervision of the Eaglehead project. Work included an 18 line-km Titan 24 geophysical survey, and a 767 line-km an airborne magnetic and radiometric survey and a 4-hole HQ diamond drilling program (three holes on the East zone and one hole on the Bornite zone) totaling 2,229.3m (Quist, 2015). Approximately 1,064 core samples were collected for analysis. Drilling intersected Cu-Mo-Au-Ag mineralization with grades like those reported in the past and proved that the mineralized system extends to greater depths than previously recognized (Quist, 2015). In addition, District Copper collected samples for preliminary rock characterization and re-logged 18 historical drillholes (5,747m)



many of which were later revisited for re-sampling and analysis of previously unsampled core intervals.

The 2014 airborne magnetic and radiometric survey was completed by Precision GeoSurveys Inc. The survey was flown at 200m line spacing at a heading of 040°/220°, with tie lines flown at 2,000m spacing at a heading of 130°/310° for a total of 767 line-km and covers a 7.8km by 18.0km area (Poon, 2014).

The total magnetic intensity (TMI), residual magnetic intensity (RMI) and calculated vertical gradient (CVG) maps illustrate a pronounced northwest-trending grain that is consistent with the known terrane boundary, and major geologic units and the lithologic or structural contacts between them (Figure 6-2).



**Figure 6-2: Total magnetic intensity map with location of mineralized zones. Turnagain Nickel Project (Giga Metals Corp.) included for spatial reference.**

To the east, the western margin of the Eaglehead pluton is clearly shown by a conspicuous increase in magnetic strength across the terrane boundary. A northwest-trending corridor, characterized by a moderate magnetic response with small, irregular-shaped moderate-to-high magnetic features, follows the western margin of the Eaglehead pluton, immediately east of the Thibert fault. The corridor coincides with biotite granodiorite mapped by Caulfield (1982) and includes the six known mineralized zones (Figure 6-3). Neither the full strike length of the corridor nor gaps between existing zones has been tested by drilling.

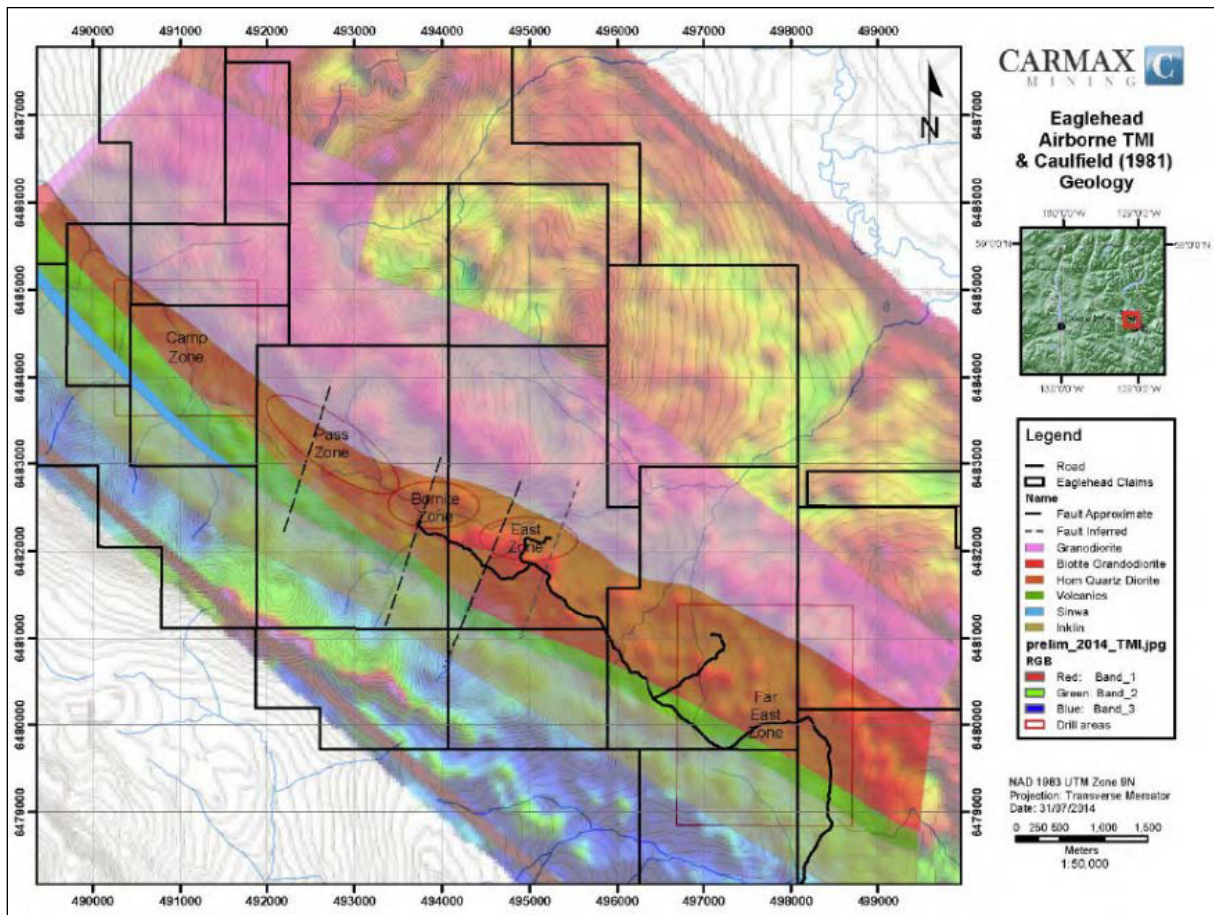


Figure 6-3: TMI Base with Claim Boundary, Geology and Mineralized Zones (after Quist, 2015; Poon, 2014)

An interpretation of the radiometric data has not been performed, but several prominent features are apparent. The central Eaglehead pluton is marked by a large, pronounced thorium/potassium (Th/K) low (Figure 6-4). Several much smaller Th/K lows occur within the northwest trending corridor mentioned above and may coincide with some of the known zones of mineralization or identify new, nearby targets.

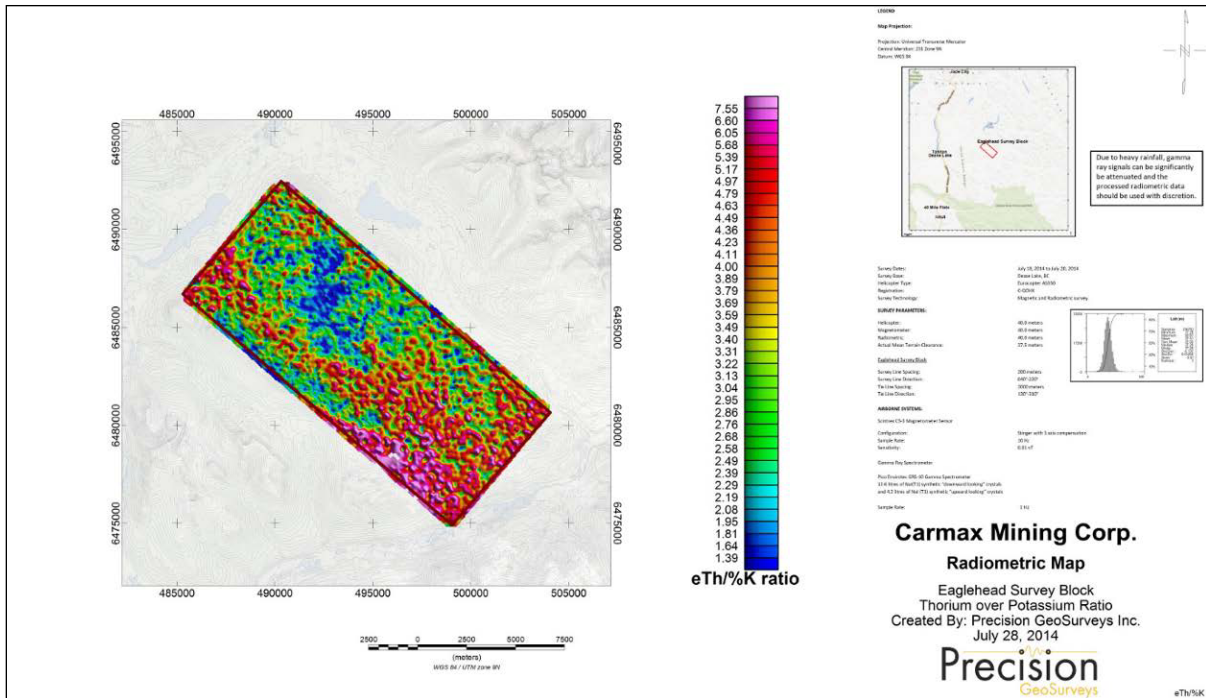


Figure 6-4: Low Th/K Signature of the Central Eaglehead Pluton

In 2014, Quantec Geoscience Ltd. was contracted by District Copper to complete an 18 line-km Titan 24 DC - IP (direct current – induced polarization) survey over the central part of the Eaglehead Project (Figure 6-5).

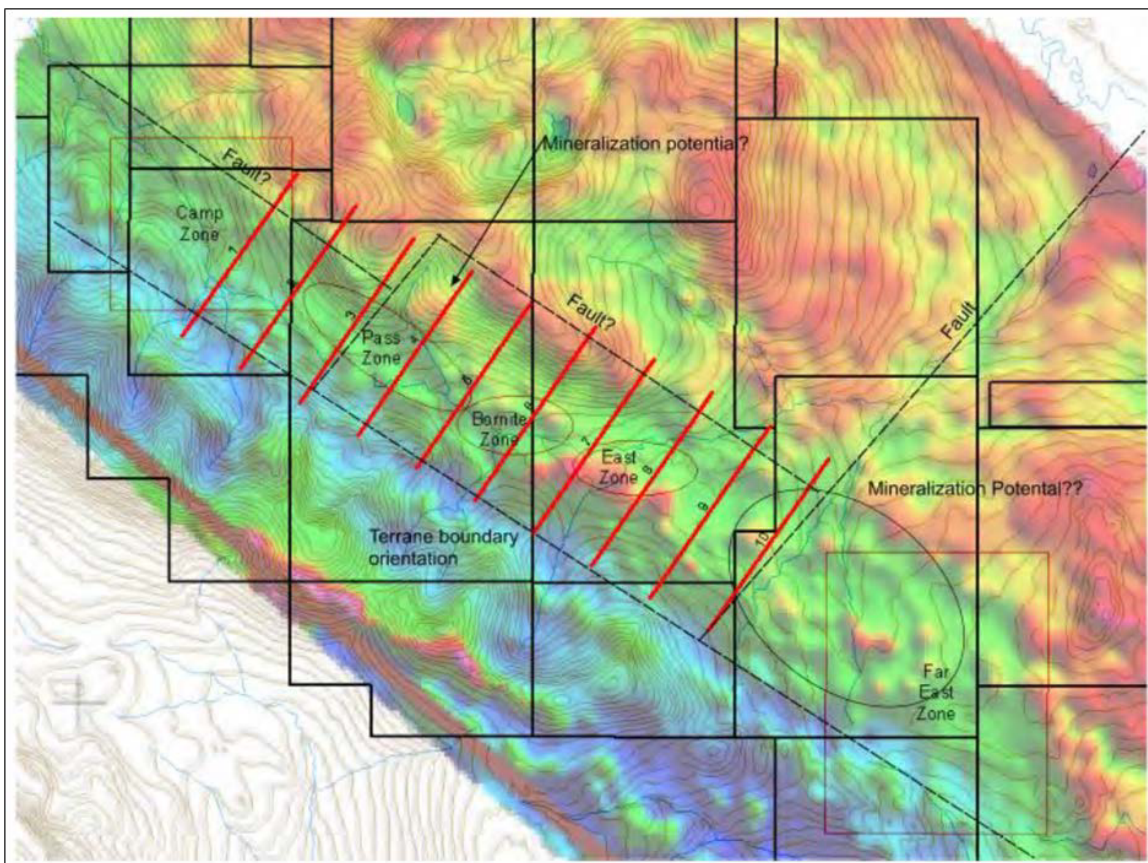
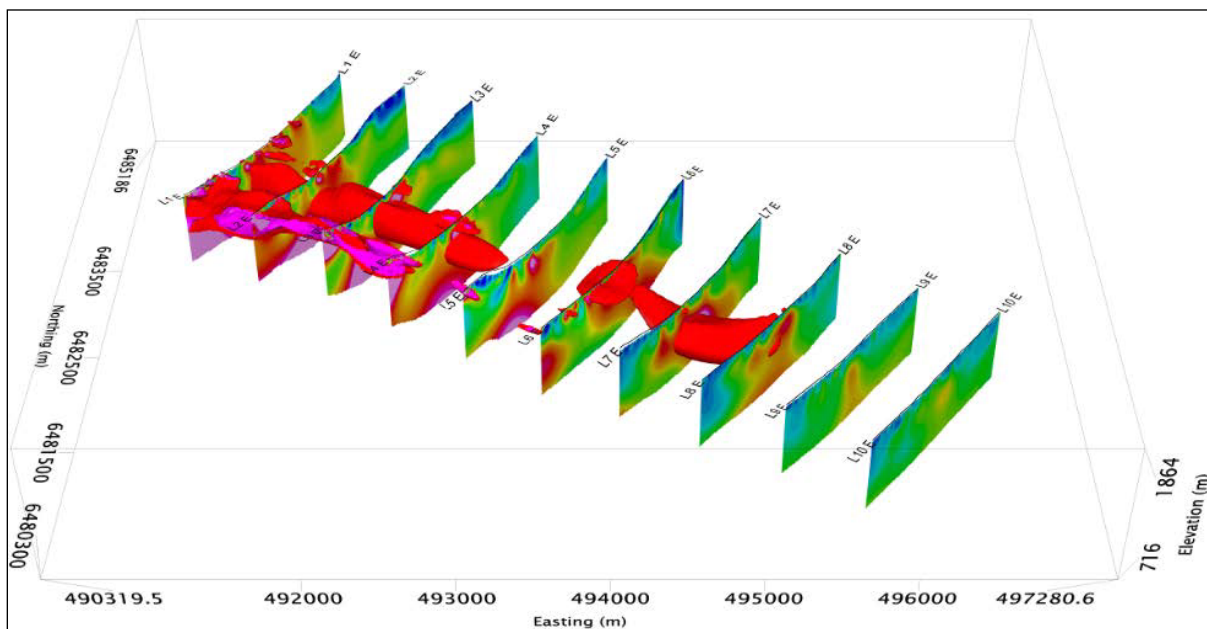


Figure 6-5: Location of 2014 IP Grid, Eaglehead Project

The survey consisted of ten 1.8km lines that followed an azimuth of 035°. Survey lines were spaced approximately 600m apart and survey stations were spaced at 75m along the lines. A pole-dipole configuration was used for DC and IP measurements. The DC and IP data were inverted using the 2D and 3D inversion algorithms to produce cross-sections and plan maps of the resistivity and chargeability distributions of the subsurface. All the inversions incorporated topography in inversion process. Plan maps of the DC and IP 2D inversions results, using DC reference and half-space (HS) reference were created for a number of selected depth intervals. Resistivity maps were plotted using a resistivity range of 300 - 10000  $\Omega$ m. Chargeability maps are plotted using a chargeability range between 0 - 40 millirads (Quantec, 2014). The objectives of the survey were to identify the geophysical characteristics of the mineralization in the East, Bornite, Pass and Camp zone and use this data to detect and define anomalies that indicate the northwest and southeast extensions of these zones. The anomalies can later be integrated into a geological model and used to guide future diamond drilling on the Project (Quantec, 2014).

The 2D and 3D IP inversion results show a strong correlation and outline a prominent, continuous southeast-northwest linear high to moderate conductivity and high chargeability anomaly (>10 millirads) in the central part of the grid that runs the entire length of the survey, a distance of more than 5.5km (Figure 6-6).



**Figure 6-6: Quantec Cross-sections of the 2D Chargeability Inversion Superimposed by the 3D Chargeability Inversion isosurfaces of 40 mrad (pink) and 35 mrad (purple)**

The anomaly appears to extend beyond the northernmost survey line 1E to the northwest but weakens to the southeast at depth beneath survey lines 9E and 10E. Within the 5.5km long linear anomaly are three distinct elevated (>20 millirads) chargeability-conductivity anomalies that are in part associated with East, Bornite and Pass zone mineralization, and one partial elevated chargeability-conductivity anomaly that coincides with southern Camp zone mineralization (Figure 6-7). Each of these anomalies persists from near surface to depths of more than 300m (Figure 6-8).



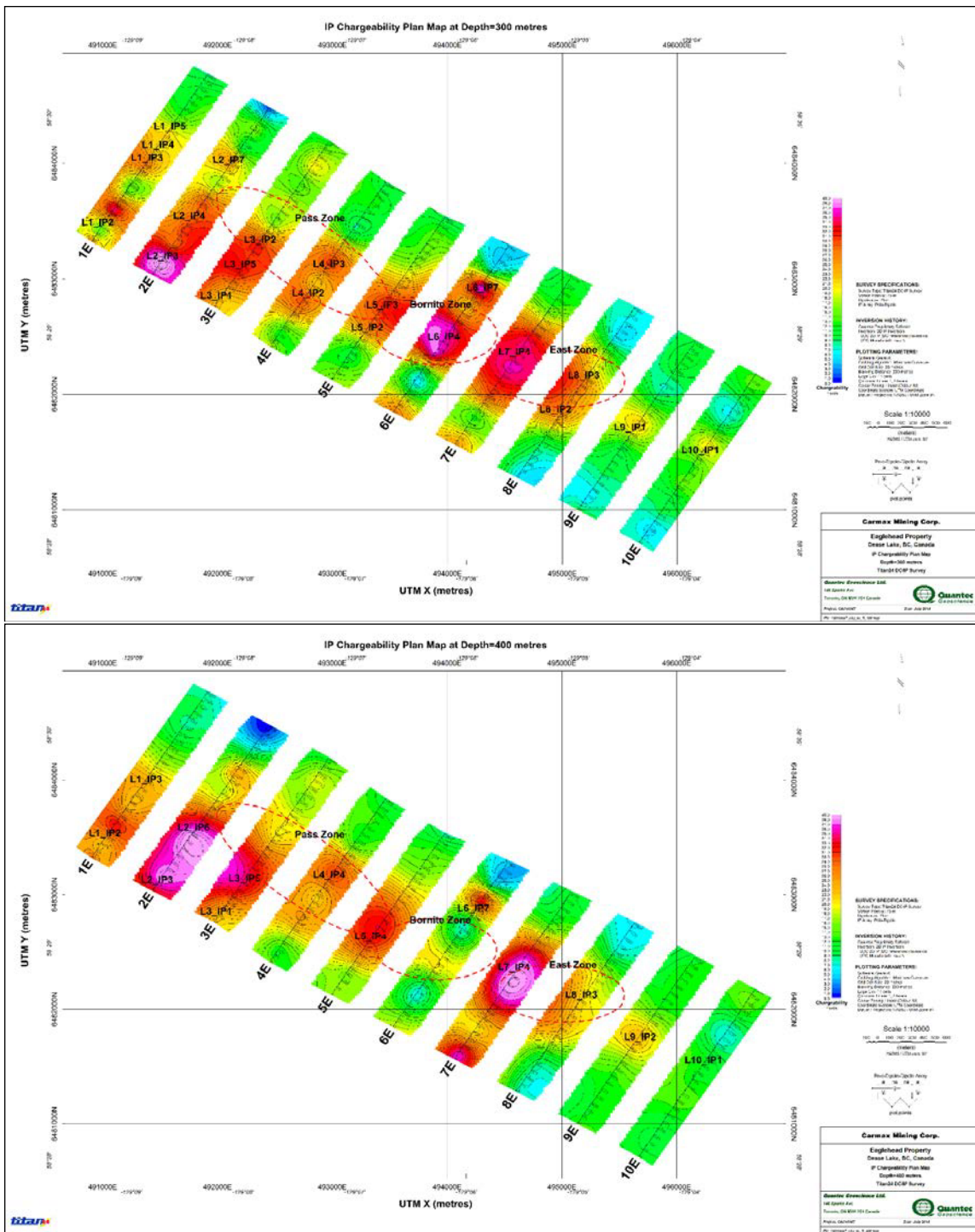


Figure 6-8: Plan Map of IP Chargeability (DC referenced) for Depths of 300m and 400m (after Quantec, 2014)

The Quantec survey outlined 36 individual high to low priority targets, 16 of which are characterized by high to moderate chargeability and high to moderate conductivity characteristics. Some of Quantec’s targets lack integration with available geological information and may be suspect (e.g., L1\_IP1 is located within Kutcho Assemblage volcanic rocks and may not contain notable copper mineralization). Therefore, more interpretation and integration with known geology and past diamond drilling results is warranted to establish drill targets. Still, many of these anomalies (i.e., L1\_IP3, L2\_LP4, L5\_IP3 and L7\_IP4; Figure 6-9) generally correlate with known zones of mineralization,

their relative location to past drilling indicates that they have not been tested, and therefore form exploration targets.

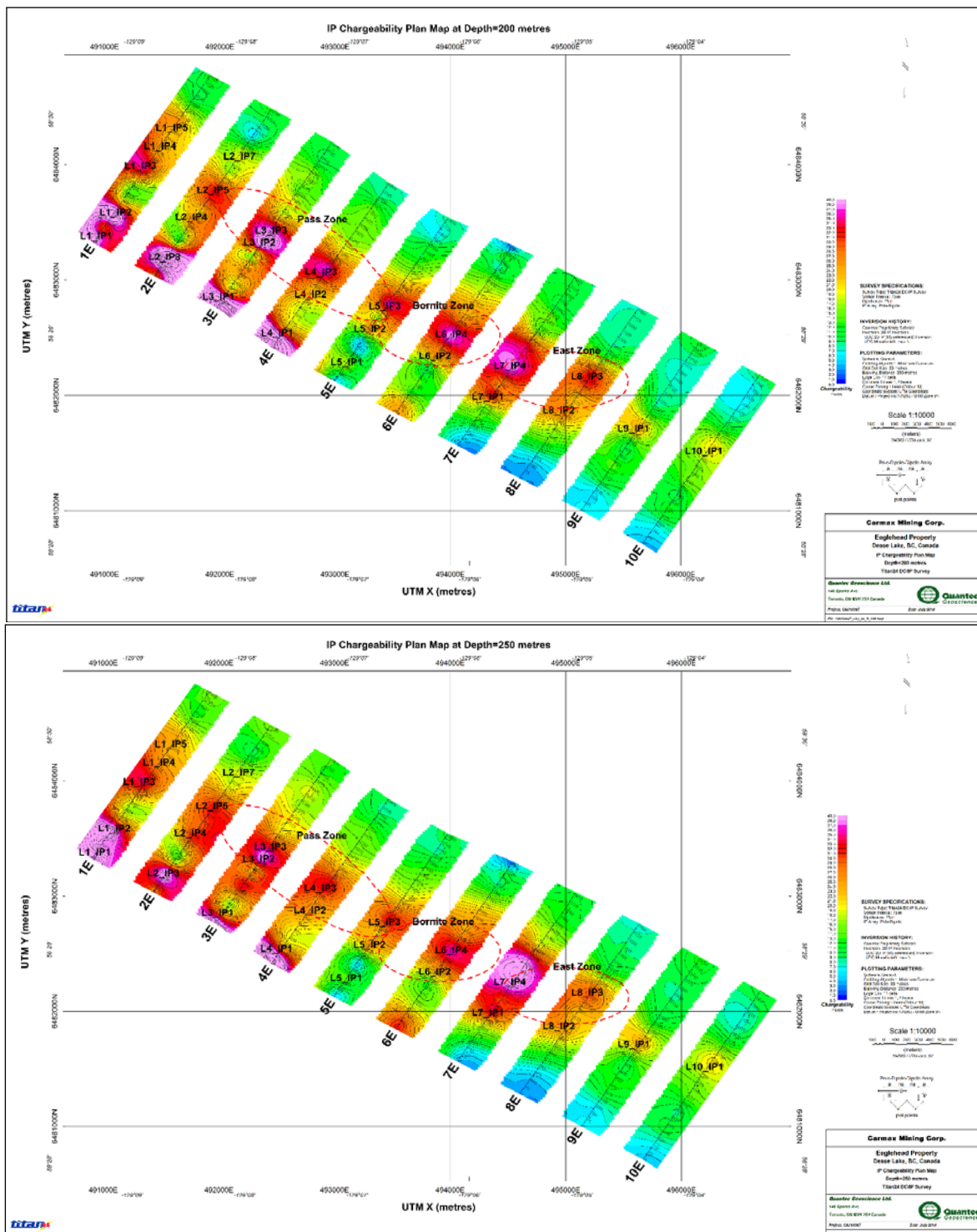


Figure 6-9: Plan Map of IP Chargeability (HS referenced) showing a number of Quantec's Priority Targets (after Quantec, 2014)

In 2015, two NQ diamond drillholes totaling 1,184.5m were completed on the Pass zone (approximately 564 core samples were collected for analysis). Hole 125 was drilled on line 4 of the Quantec survey and hole 126 was drilled on line 5 of the Quantec survey; each hole tested a

chargeability/resistivity signature identified in 2014 (Stewart, 2016). Re-logging of historical drillholes continued in 2015 and included 10 holes (2,103.8m), two of which required sampling and analysis of previously unsampled core intervals.

In 2016, District Copper under the supervision of Copper Fox conducted extensive re-logging, sampling and/or re-sampling of either un-split or split core intervals from 40 historic drillholes (13,562m), re-analyzed (using 4 acid digestion) approximately 15,000 pulp and core samples from historic drill core, and completed additional metallurgical work. The re-analyses of the pulp and core samples was required because the original analyses were completed using aqua regia digestion. The work contributed meaningfully to upgrading the quality of the Project's data base. The results of the metallurgical studies are summarized in Section 13 of this report.

There was no exploration conducted on the Project in 2017. However in 2018, the Company under the supervision of Copper Fox completed a field program that included: i) re-logging of 36 historical diamond drillholes (7,789m); ii) sampling and re-sampling of 19 historical diamond drillholes (917 samples) for copper, molybdenum, gold, silver and a suite of trace elements ; iii) recovery of additional historical diamond drill core from the Camp zone; and iv) re-visiting previously mapped outcrops as part of a compilation reconnaissance program to obtain alteration data and determine controls on copper mineralization for a portion of the Eaglehead intrusion underlying the Camp zone and the area north of the Camp and Pass zones (Stewart, 2018; Marsh, 2018).

There was no exploration completed on the Eaglehead project in 2019 or 2020.

In 2021, Copper Fox through its wholly owned subsidiary Northern Fox Copper, conducted a field program consisting of re-logging and sampling or re-sampling 1573.75 meters of historical drill core from the Far East zone, 293 samples of historical drill core from the Far East zone, 18.0 kms of chargeability/resistivity survey, re-interpretation and updated modelling of the 2014 high sensitivity airborne geophysical survey and initiated a stream water sampling program to establish a stream water quality baseline for the project.

The 2021 geophysical survey located a positive chargeability body of >10 mrad, approximately 2500m by 1200m in size located 950m north of the Camp and Pass zones. The survey completed 3 read lines 3.6km in length (totalling approximately 10.8kms) that followed an azimuth of 035°. Quantec's ORION Swath DCIP survey configuration was used to survey lines spaced approximately 600m apart and receiver stations spaced at 100m along the lines. Two complete ORION Swath spreads and one partial ORION Swath spread were surveyed. 2D DC resistivity and chargeability inversion models were generated for each subset of inline data as well as 3D inversion models of the full inline and crossline dataset. Additionally, the data from the present surveys were merged with previously acquired TITAN 24 DCIP covering 3 of the survey lines. Additional 2D DC resistivity and chargeability inversion models were generated for each subset of merged inline data. For completeness, 3D inversion models of the full merged dataset were also performed.

Interpretation was done on a line-by-line basis, primarily based on the DCIP results but also considering known mineralized zones and structures identified in geologic and geophysical data provided by Copper Fox. Several low to moderate resistivity features and moderate to high chargeability features that may be of interest were identified along each line.

The results of 3D inversion of the full ORION Swath dataset have delineated distribution of resistivity exhibiting lineaments consistent with results of airborne magnetic surveys and potentially related to



interpreted geologic structure as well as potential zonations within the prospective porphyry system at the Eaglehead project. A zone of moderate chargeability, zone IP-2, associated with lower resistivity has been delineated by 3D inversion centered along line 1600E from 2000N to 2900N at elevation of approximately 1300 m ASL. A second zone of low resistivity and corresponding moderate to high chargeability is delineated underlying the area over which TITAN 24 surveys were performed in 2014.

The DC and IP data were inverted using the 2D and 3D inversion algorithms to produce cross-sections and plan maps of the resistivity and chargeability distributions of the subsurface. All the inversions incorporated topography in inversion process. Plan maps of the DC and IP 2D inversions results, using DC reference and half-space (HS) reference were created for a number of selected depth intervals. Resistivity maps were plotted using a resistivity range of 300 - 10000  $\Omega\text{m}$ . Chargeability maps are plotted using a chargeability range between 0 - 40 millirads (Quantec, 2021). Using the 10mrad chargeability contour the chargeability signature outlined a north (35-40) dipping chargeability body, the western portion of which is exposed in the valley floor and the south facing slope of the hills located on the north side of the valley (Figure 6-10) and indicates a good correlation to the porphyry style mineralization intersected by the drilling in the Camp and Pass zones.

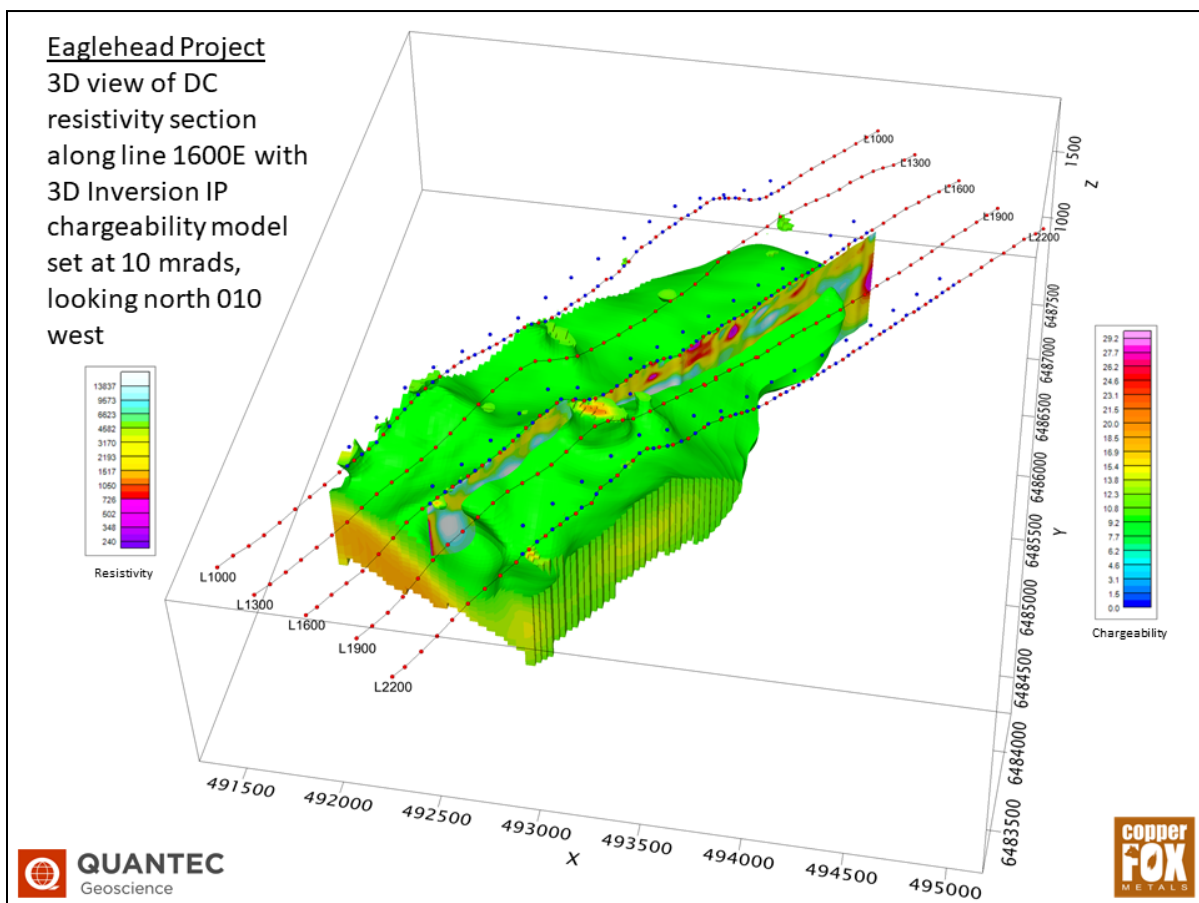
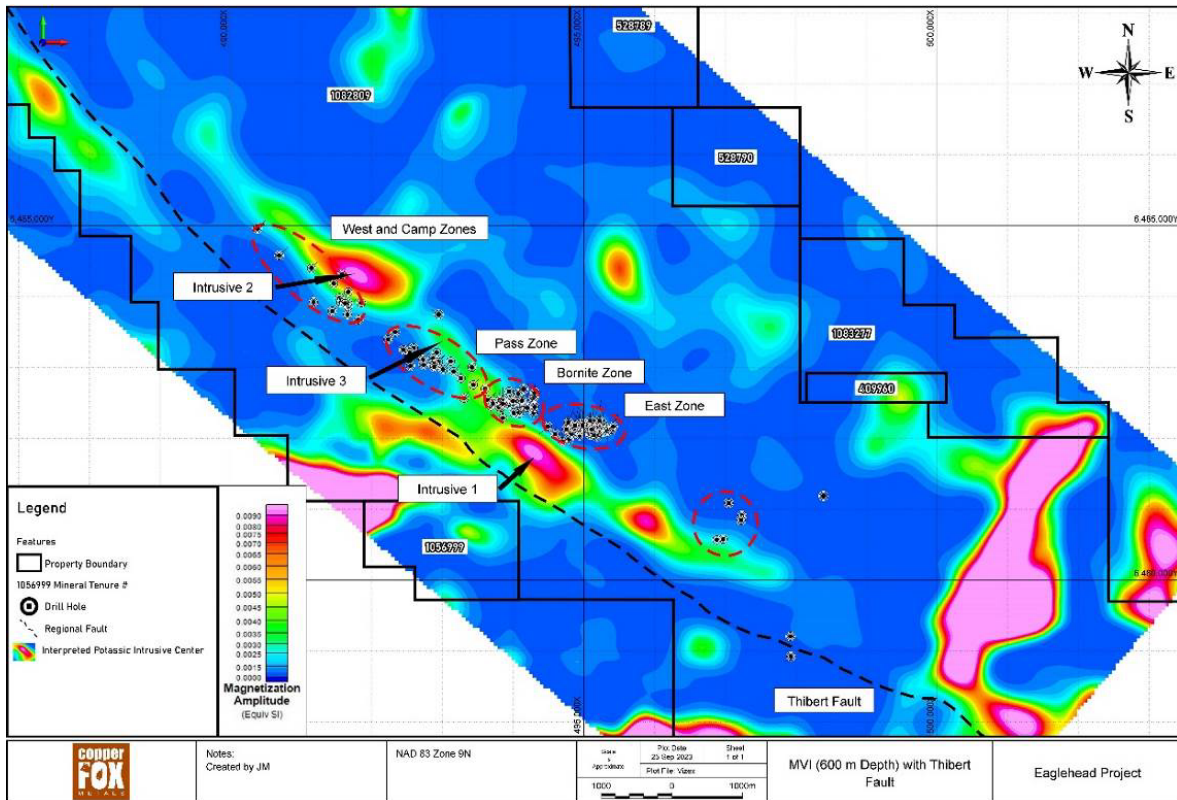


Figure 6-10: 2021 geophysical survey- chargeability anomaly Eaglehead project

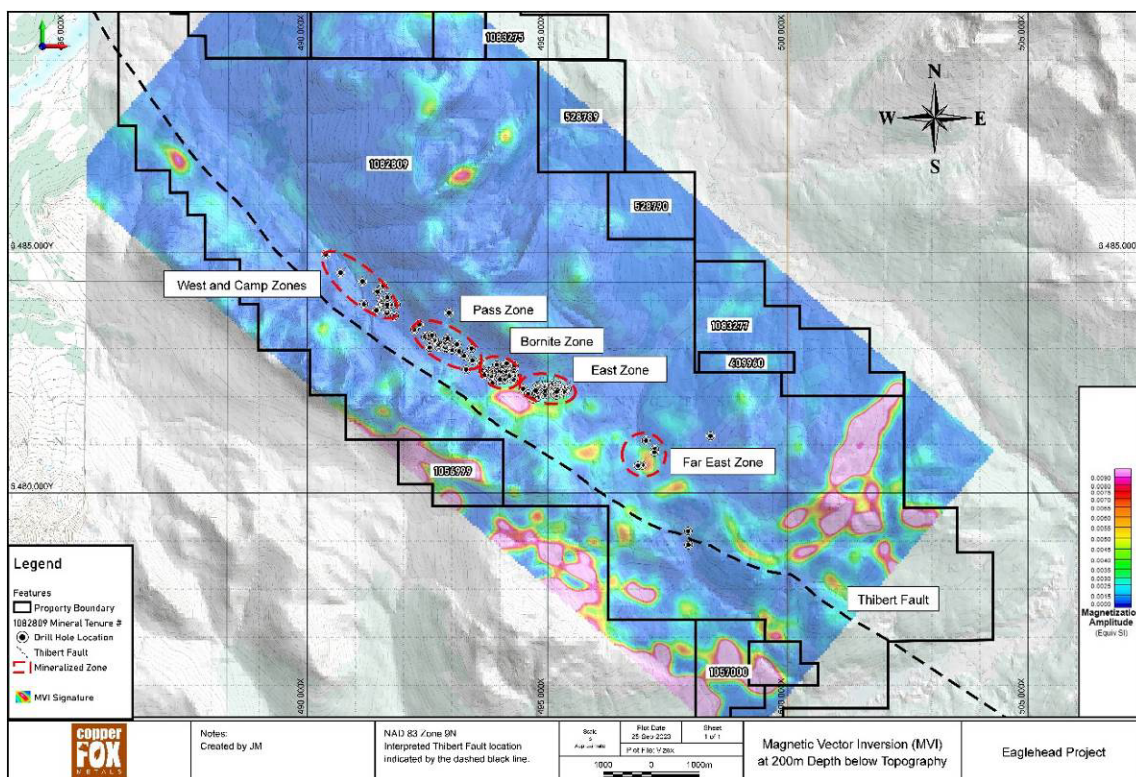
Following completion of the 2021 geophysical survey, the data sets from 2014 and 2021 were combined as shown in Figure 6-11.



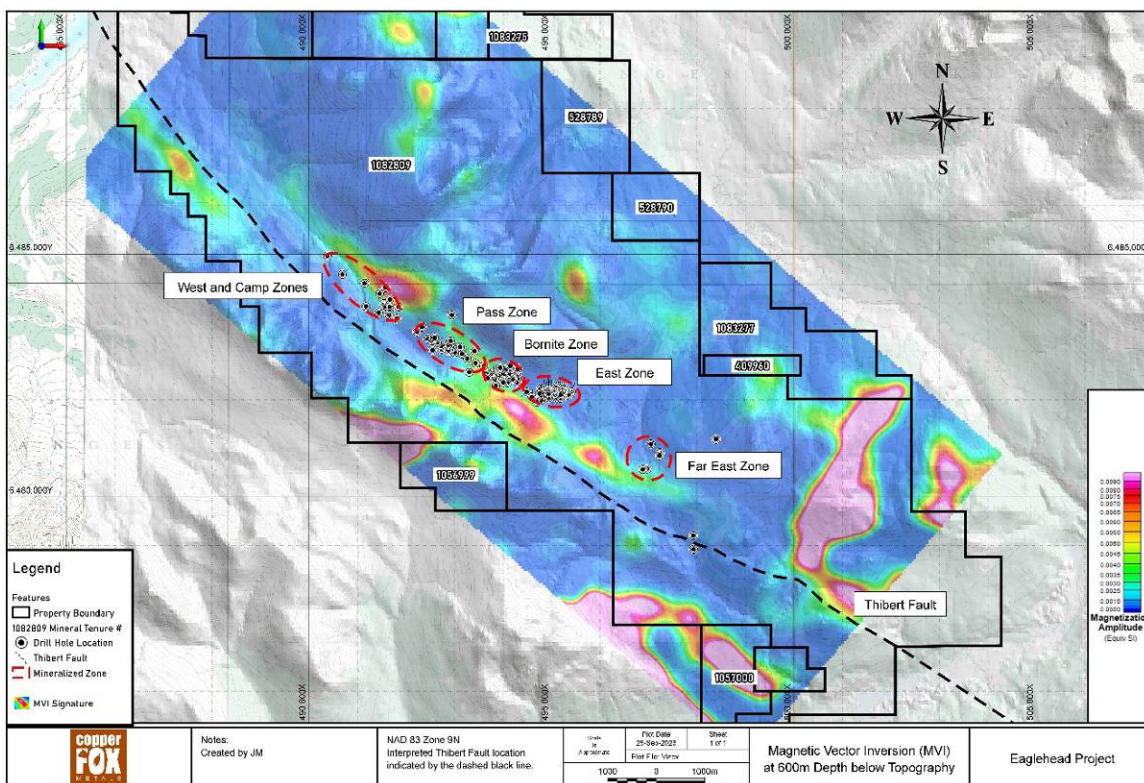


**Figure 6-12: MVI at 600m depth. Location of interpreted intrusive centers near drilling.**

One of the MVI anomalies is located on the south side of the interpreted surface trace of the Thibert Fault zone underlying a hornblende quartz diorite intrusive. Reconnaissance mapping in this area located widespread secondary copper (malachite) mineralization in leached quartz veinlets, fractures and as disseminations.



**Figure 6-13: Magnetic Vector Inversion anomaly map at 200m level below surface, Eaglehead project.**



**Figure 6-14: Magnetic Vector Inversion anomaly map at 600m level below surface, Eaglehead project.**

In 2021, a re-interpretation and modelling of the historical soil geochemical data for the Eaglehead project was completed, Figure 6-15. The copper in soil values demonstrate a strong correlation to the mineralized zones. The copper in soil concentration southeast of the East zone toward the Far East zone suggests glacial dispersion to the southeast.

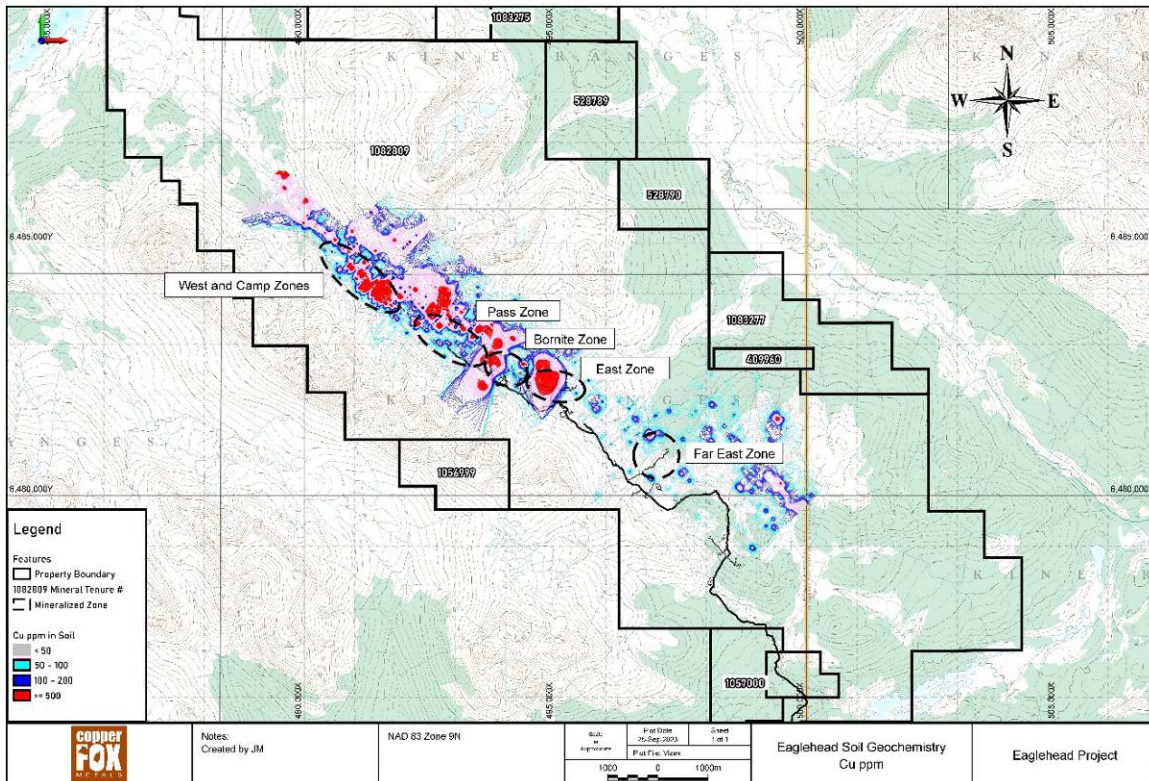


Figure 6-15: Copper in soil geochemical anomaly, Eaglehead project.

In 2022, Copper Fox continued collection of additional lithologic, alteration and structural data to model the geology and alteration patterns associated with the porphyry style mineralization within the mineralized corridor. The 2022 field activities consisted of a review and compilation of the lithologies, alteration and mineralization in 34 historical drillholes, sampling of 194.03 meters (20 mineralized intervals in 11 drillholes) of unsampled drill core, re-analyses of 270 sample pulps utilizing a four-acid digestion (original analyses completed using aqua regia digestion), review of 54 historical drillholes collecting systematic data to update the geological model; reconnaissance scale mapping, prospecting; age-dating and petrographic studies; an archaeological assessment, and stream water sampling to progress the stream water quality baseline analysis.

The updated geological and alteration models for the portion of the Eaglehead intrusive underlying the mineralized corridor are shown in Figure 6-16 and Figure 6-17.

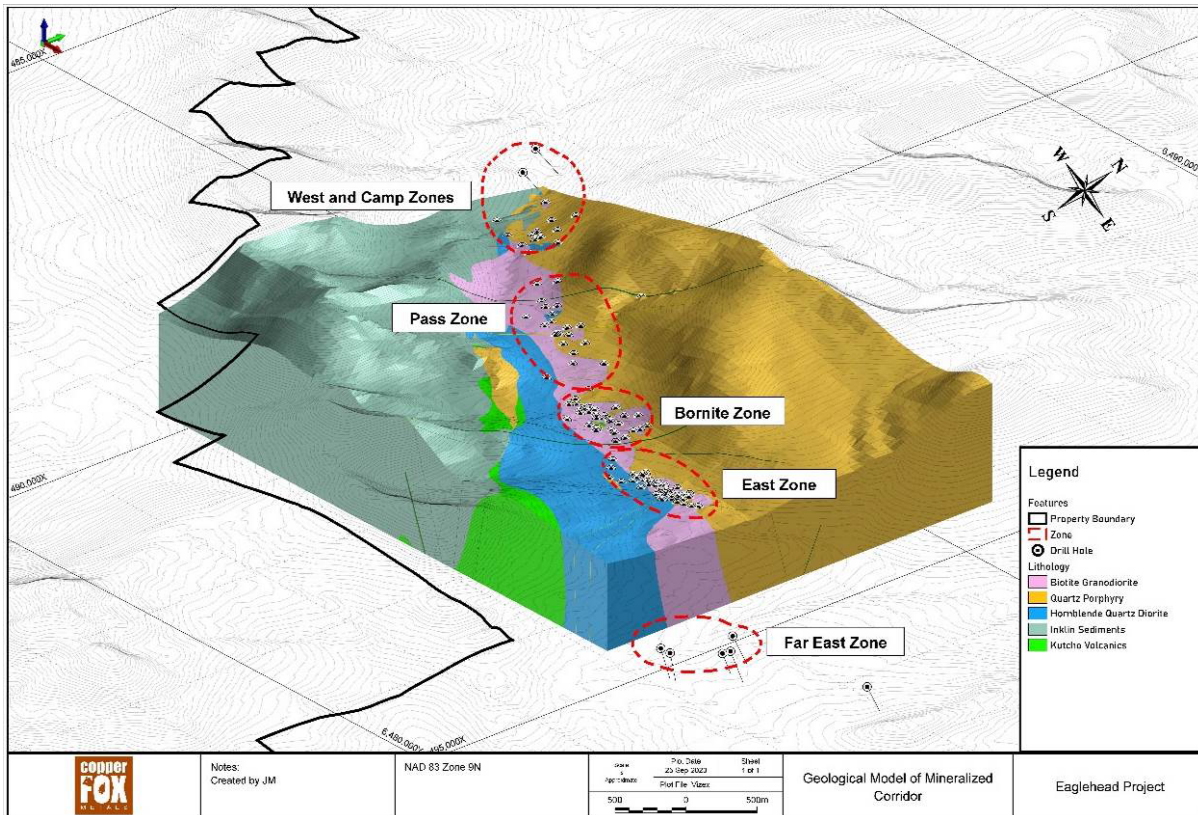


Figure 6-16: Geological model of mineralized corridor, Eaglehead project.

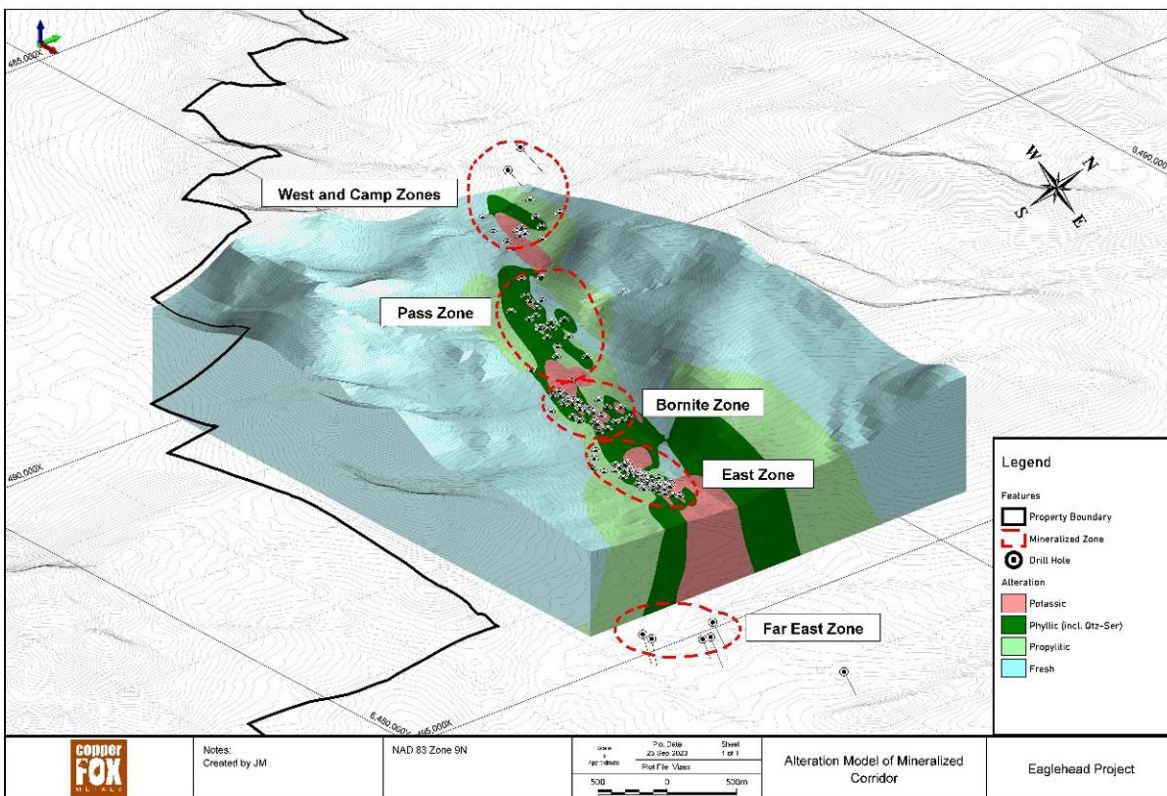


Figure 6-17: Alteration model, mineralized corridor, Eaglehead project.

Age dating (U/Pb zircon, based on 12 determinations) completed by the Pacific Centre for Isotopic and Geochemical Research located in Vancouver, British Columbia. of the intrusive phases of the Eaglehead pluton indicates crystallization of the older marginal phase hornblende quartz diorite at (195.1+/-0.13Ma) and the younger quartz porphyry at (194.8 +/-0.1Ma) comparable to other calc-alkalic copper porphyry systems in British Columbia. Earlier age dating (K-Ar on biotite) determined an age of the biotite hornblende granodiorite at 186+/-7 Ma. Age dating (Re-Os) of a sample of molybdenite mineralization collected from DDH-116 at core depth of 159.5m yielded a 194.2 +/- 0.9 Ma. date indicating emplacement of the copper-molybdenum mineralization approximately 500,000 to 700,000 years after crystallization of these phases of the Eaglehead intrusive (Antofagasta; personnel communication).

## **6.1 Assessment of Historic Exploration Data**

Northern Fox with the financial and technical support of Copper Fox, initiated a detailed re-examination of as many historic drillholes as could be recovered from the core stored on the project. The purpose of the re-examination was to identify an exploration model and compile all available technical data into a workable porphyry copper model for the project. The re-examination included re-logging, re-sampling of split core intervals, sampling of previously unsampled core intervals, surface mapping, modelling of the magnetic, lithologic and alteration data. In addition, 270 drill core sample pulps were re-analyzed using four-acid digestion and fire assay techniques to eliminate inconsistencies in analytical techniques in the project database. The results of this work are summarized in Sections 7, 9 and 10 of this report.

The tabulated list of the exploration history of the Eaglehead Project, based on a review of all available assessment and private reports is provided in Table 6-1.

**Table 6-1: Summary of Exploration Activities, Eaglehead Project**

Year(s)	Company	Summary	Drilling (m)
1963	Kennco Explorations Limited ("Kennco")	Staked the Joy claims to cover what is now the Eaglehead Project; conducted a geochemical survey of stream and seepage sediments, as well as an IP survey and geological mapping.	
1965	Kennco	Drilled four short holes in the Camp and Pass zones; the claims were later allowed to lapse.	450.0
1970	Spartan Exploration Ltd. ("Spartan"); Esso Resources Canada ("Esso")	Re-staked the property as the Eagle claims; in 1971, optioned it to Esso Resources Canada ("Esso"); Spartan was later re-organized as Nuspar Resources Ltd. ("Nuspar").	
1971	Esso / Nuspar	Joint venture partnership staked additional claims and completed a detailed geochemical survey over the mineralized zones; also completed bedrock mapping and collected basic structural measurements.	
1972	Esso / Nuspar	Conducted an IP survey and drilled 6 BQ core holes in the Camp and Pass zones.	1,183.6
1973	Esso / Nuspar	Drilled 19 core holes in the Camp, Pass and Bornite zones. No official assessment report containing drillhole logs or assays for these holes exists; their locations are noted in later reports.	3,380.5
1975	Esso / Nuspar	Completed bedrock mapping and collected soil samples; soil samples revealed anomalous Cu-Mo values in the Camp zone.	
1976	Esso / Nuspar	Drilled 5 BQ diamond core holes in the Camp, Pass, Bornite and East zones.	1,044.9
1979	Nuspar / Esso	Nuspar assumed operatorship; reviewed all available data; extended the 1963 and 1972 IP survey grids; collected 242 soil samples and 75 silt samples; drilled 5 BQ core holes in the Pass and Bornite zones.	877.3
1980	Nuspar / Esso	Drilled 9 BQ core holes and collected 165 soil samples; employed Geophysical Aero Data Ltd. to fly 77.6 line-km of airborne VLF-EM and Mag.	1,638.9
1981	Nuspar / Esso	Drilled 11 NQ/BQ holes; collected 813 soil samples; conducted a ground horizontal loop EM survey and an IP survey.	3,668.1
1982	Esso / Nuspar	Esso assumed control of the property; completed a program of soil sampling, mapping and IP surveying (34 line-km).	
1989	Homestake Canada Ltd. / Nuspar	Homestake Canada Ltd. ("Homestake") purchased Esso's interest in the property.	
1990	Homestake / Nuspar	Collected 98 soil samples.	
1992	Homestake / Nuspar	Collected 72 soil samples.	



Year(s)	Company	Summary	Drilling (m)
2001		Claims are allowed to lapse.	
2002	Poloni	Claims staked by the Poloni family; a small reconnaissance program of examining drill core and locating old survey grids and drillhole collars was undertaken.	
2004	Poloni & Peters	J.R. Poloni and E.S. Peters assumed ownership of the claims; collected 173 soil samples.	
2005	Poloni & Peters	Completed 25.8 line-km of ground IP over the Bornite, East and Far East zones. Later in the year Carmax Explorations Inc., predecessor to District Copper Mining Corp., entered into a joint venture agreement with Poloni and Peters to earn a 100% interest in the property.	
2006	District Copper	Completed 10 NQ diamond drillholes in the East, Bornite and Far East zones.	3,050.3
2007	District Copper	Completed 43.8 line-km of ground IP to extend the 2005 IP grids; the 2005 and 2007 IP data was inverted to create a 3D model; 139 soil geochemical samples were collected; 12 NQ diamond drillholes were completed on the Bornite, East and Far East zones.	4,101.0
2008	District Copper	Completed 14 NQ drillholes in the East and Far East zones.	5,495.3
2011	District Copper	Completed 25 NQ drillholes in the Bornite and East zones.	8,302.1
2012	District Copper	Retained Rosco Postle Associates Inc., to complete a National Instrument 43-101 technical report and mineral resource estimate for the Project.	
2014	District Copper	Completed 4 HQ diamond drillholes, an 18 line-km Titan-24 DC-IP ground survey, 787 line-km of combined airborne magnetic and radiometric survey, re-logged 18 historical drillholes (5,747 m) and collected samples for a preliminary rock characterization study.	2,229.3
2015	District Copper	Completed 2 NQ diamond drillholes, re-logged and sampled and/or re-sampled 10 historic diamond drillholes and conducted preliminary metallurgical characterization.	1,184.4
2016	District Copper	Completed re-logging, sampling and/or re-sampling of either unsplit or split core intervals from 40 historic drillholes (13,562 m); re-analyzed approximately 15,000 pulp and core samples from historic drill core; completed additional metallurgical work.	

Year(s)	Company	Summary	Drilling (m)
2018	District Copper	Completed a field program that included: i) re-logging of 36 historical diamond drillholes (7,789m); ii) sampling and re-sampling of 19 historical diamond drillholes (917 samples) for copper, molybdenum, gold, silver and a suite of trace elements ; iii) recovery of additional historical diamond drill core from the Camp zone; and iv) re-visiting previously mapped outcrops as part of a compilation reconnaissance program to obtain alteration data and determine controls on copper mineralization for a portion of the Eaglehead intrusion underlying the Camp zone and the area north of the Camp and Pass zones	
2021	Copper Fox	Completed a field program consisting of i) re-logging five historical drillholes (1,828.9m) in the Far-East zone, ii) 293 core samples (659m of drill core), iii) 10.8 kms of chargeability/resistivity survey, iv) modelling and re-interpretation of the 2014 high sensitivity airborne magnetic survey and v) initiated a stream water sampling program to establish a stream water quality baseline for the project and vi) surface mapping of the geophysical lines and other portions of the property.	
2022	Copper Fox	Completed a field program consisting of i) re-logging of 34 historical drillholes, ii) sampling of 194.03 meters ('m') (20 mineralized intervals in 11 drillholes) of unsampled drill core, iii) re-analyses of 270 sample pulps utilizing a four-acid digestion, iv) review of 54 historical drillholes; v) reconnaissance scale mapping and prospecting; vi) age-dating and petrographic studies; vii) an archaeological assessment, viii) and stream water sampling to progress the stream water quality baseline analysis.	

## **7 Geological Setting and Mineralization**

### **7.1 Geological and Structural Setting**

The Eaglehead Project is located at the southern margin of the Quesnel terrane immediately north of the terrane bounding fault that separates it from the Cache Creek terrane to the southwest (Figure 7-1). In the project area, the Quesnel terrane is described as a narrow structurally complex zone of mainly Mesozoic intrusive rocks. It is flanked to the north by Paleozoic sedimentary rocks of Ancestral North America. To the south, the Quesnel terrane is in structural contact with an Upper Paleozoic oceanic assemblage of the Cache Creek terrane.

The Cache Creek terrane is represented mainly by the Cache Creek complex, which includes structurally interleaved slices of chert, argillite, basalt, carbonate, wacke, gabbro, and alpine ultramafic rocks that range in age from Early Mississippian to Early Jurassic (Monger, 1975; Gabrielse, 1998; Mihalynuk et al., 2004). In the Project area, the Quesnel terrane consists of a Triassic to Early Jurassic Island arc assemblage dominated by the Eaglehead pluton (Gabrielse, 1994; Gabrielse, 1998).

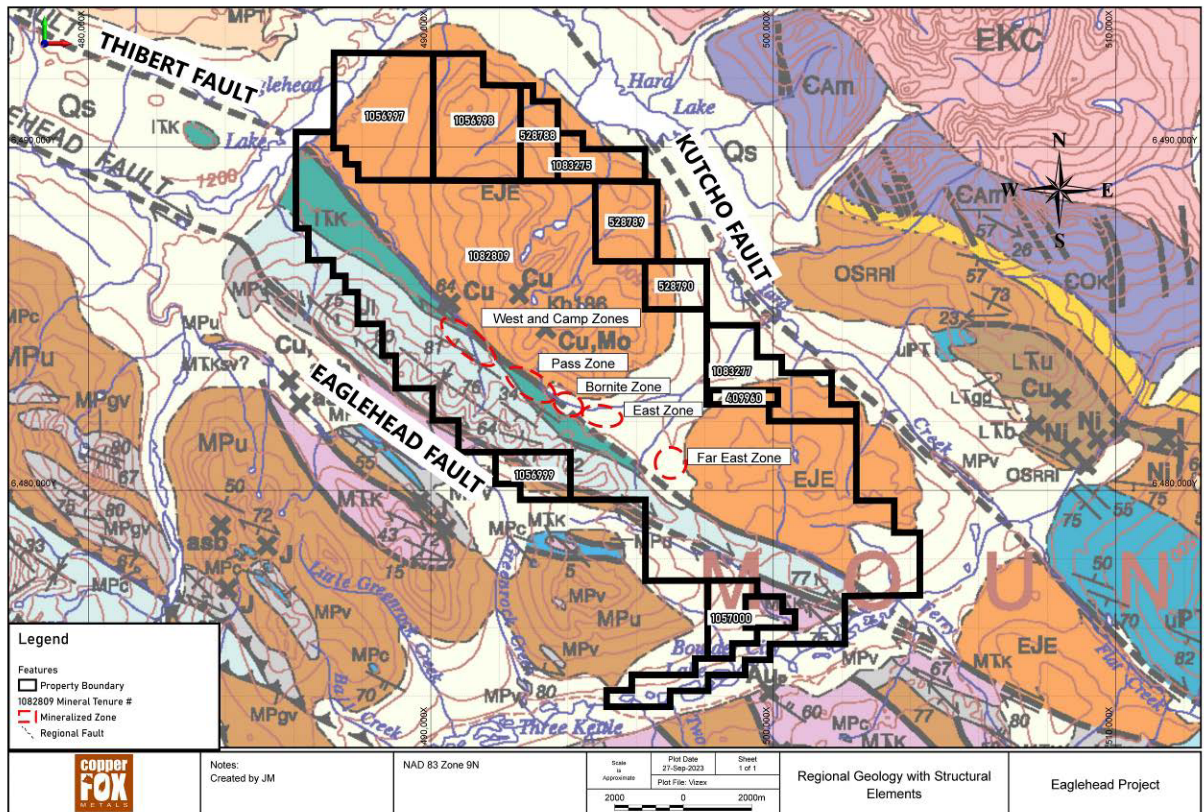
The Project lies along the southwestern flank of the Eaglehead pluton, a zoned Early to Late Jurassic batholith that is elongated in a northwest-southeast direction subparallel to the main structural fabric in the area (Figure 7-2 and Figure 7-3). The pluton is bounded on its northeast side by the Kutcho fault, a major northwest-trending fault characterized by a 1.5-3.0 km zone of strongly cataclastized, foliated and mylonitized rocks with dextral lateral movement in the order of several tens of kilometers (Gabrielse, 1998). The southwestern flank of the Eaglehead pluton is in structural contact along the Thibert fault with a sliver of Permo-Triassic bimodal volcanic and volcanoclastic rocks of the Lower Triassic Kutcho Assemblage and sedimentary rocks of the Whitehorse Trough. The Kutcho Assemblage is stratigraphically overlain by sedimentary rocks of the Whitehorse Trough, including well-bedded greywacke, conglomerate, and siltstone of the Lower to Middle Jurassic Inklin Formation and thin-bedded limestone of the Upper Triassic Sinwa Formation.

The Thibert fault is likely part of the Kutcho fault system, and these faults are interpreted to connect near the Turnagain River (Gabrielse, 1998). A third northwest trending fault, the Eaglehead fault, lies west of the Thibert fault and separates the clastic sedimentary rocks of the Inklin Formation from the phyllites and schists of the Kedahda Formation.



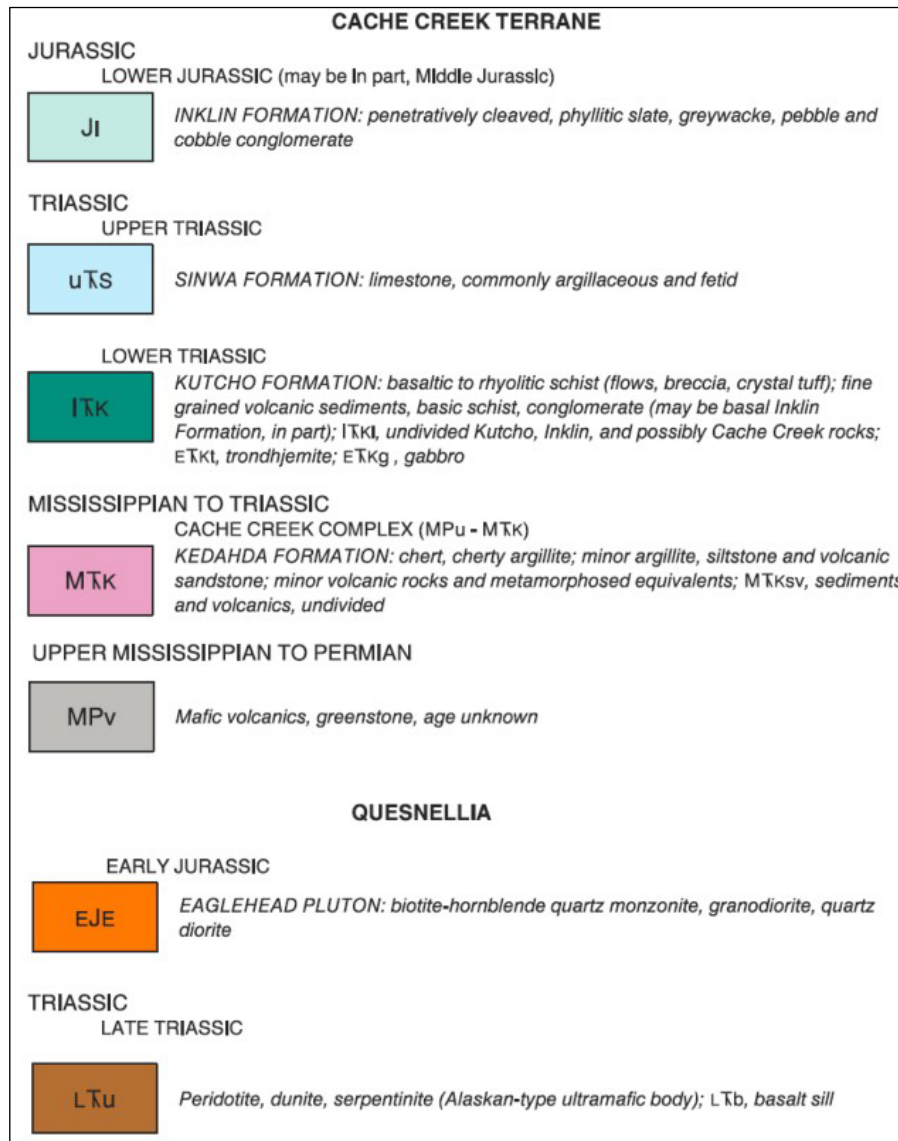
(Source: Massey et al., 2005)

**Figure 7-1: Simplified Terrane Map of the British Columbia showing Distribution of Select Alkalic and Calc-alkalic Porphyry Deposits**



(Source: Gabrielse, 1994)

**Figure 7-2: Regional Geology and Structural Elements of the Eaglehead Project Area (after Gabrielse, 1994)**



(Source: Gabrielse, 1994)

**Figure 7-3: Regional Geology Legend for Figure 7-2**

## **7.2 Property Geology**

The central part of the Eaglehead Project was mapped in 1982 by Caulfield who subdivided this portion of the Eaglehead pluton located within the Project into three phases being in order from south to north:

1. hornblende quartz diorite,
2. biotite granodiorite, and
3. porphyritic granodiorite.

Caulfield (1982) describes the contact between the hornblende quartz diorite, as seen in drill core, as gradational over several tens of meters as indicated by an increase in biotite at the expense of hornblende. Caulfield also noted that the intrusive phases were cut by aplitic dykes, pegmatitic dykes, mafic dykes, and quartz feldspar porphyry dykes. The mafic dykes and quartz feldspar porphyry dykes were reported to cross-cut areas of copper mineralization.

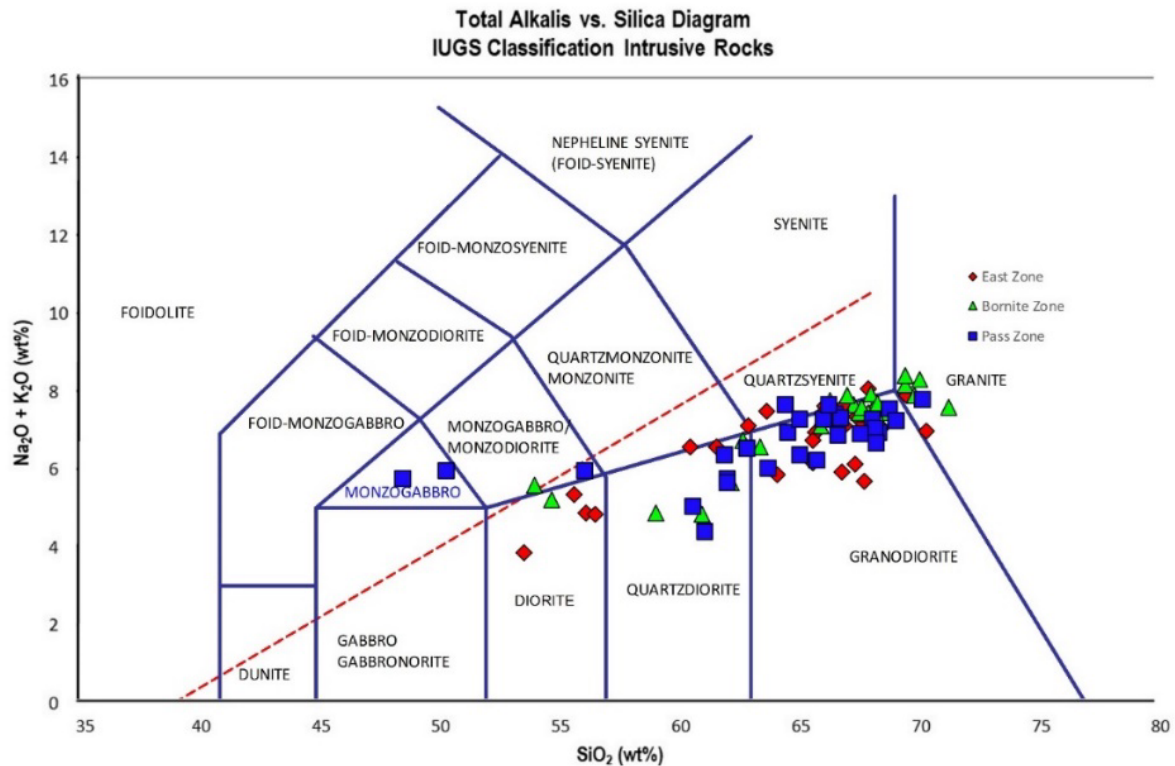
### **7.2.1 Eaglehead Pluton**

The Eaglehead Pluton is an elongated intrusive body that measured approximately 80kms in length and up to 8-10kms wide located south of the regional scale Kutcho fault system and north of the Thibert fault system, a second order fault to the Kutcho system.

Extensive re-logging of drill core by Copper Fox has modified the relationship between the intrusive phases defined by Caulfield that indicates an intrusive contact relationship between the hornblende quartz diorite and the biotite granodiorite and a gradational contact between the biotite granodiorite and quartz porphyry. These main intrusive phases are cut by late stage aplitic, pegmatitic, mafic, hornblende porphyry and both mineralized and non-mineralized quartz feldspar porphyry dikes. The geological model for that area of the Eaglehead pluton hosting the zones of porphyry style mineralization is shown later in Figure 7-4.

### **7.2.2 Intrusive Rocks**

To gain a better understanding of the identified intrusive phases, Copper Fox completed whole rock geochemical analyses on 91 select samples of the intrusive phases from the East, Bornite and Pass zones within the mineralized corridor hosting the porphyry style copper mineralization. Using the IUGS system (total alkali to silica ratio) for classification, the select samples primarily plot in the diorite – quartz diorite – granodiorite fields (see Figure 7-4).

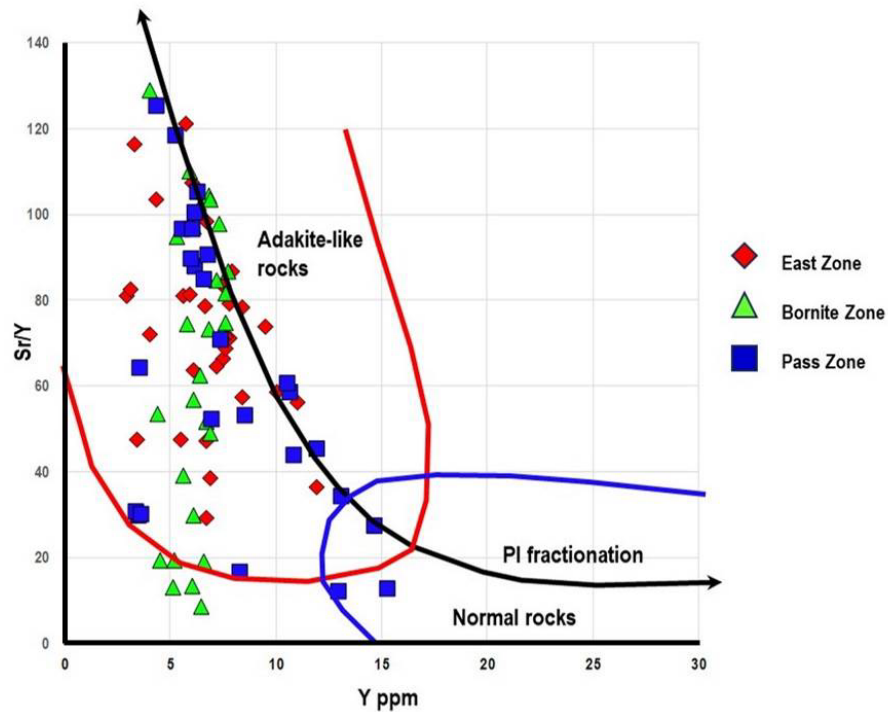


(Source: Castillo et al. (1999) and Richards and Kerrich (2007))

**Figure 7-4: Total Alkali vs Silica geochemistry of the Pass, Bornite and East mineralized zones, Eaglehead project.**

Recent studies have shown that certain intrusive rock suites contain mineralogical and geochemical indicators minerals such as hornblende and elements such as strontium and yttrium that can be used to indicate water content and oxidization state of a magma. The Sr/Y and other elemental ratios are commonly referred to as “fertility indices” that could indicate the potential of the magma to generate a porphyry copper deposit. The 91 samples used for whole rock geochemistry were also analyzed for a suite of 48 elements including strontium and yttrium. The geochemistry demonstrated that samples from the various intrusive phases of the Eaglehead intrusive within the mineralized corridor have high Sr/Y vs Y ratios, indicative of moderate to very strong “Adakite” type affinities (Figure 7-5). Fields and fractionation trends from Fractionation trends modeled assuming an average medium-K, calc-alkaline andesite (Gill, 1981) and partition coefficient values from Bachmann et al. (2005)



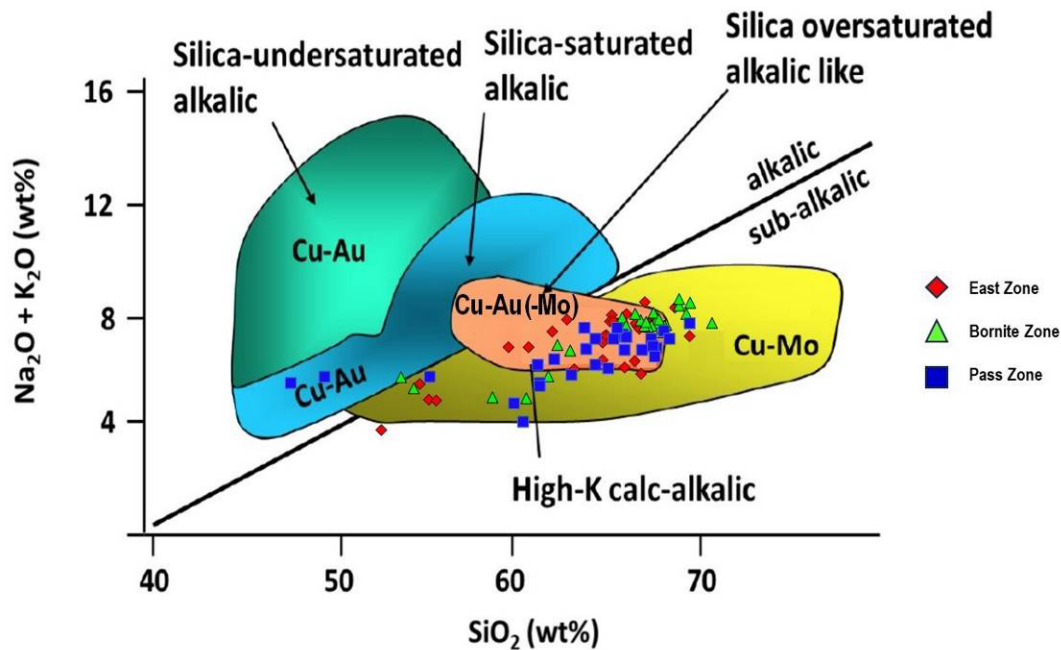


(Source: Castillo et al. (1999) and Richards and Kerrich (2007))

**Figure 7-5: Plots of Sr/Y vs. Y for samples from the Eaglehead Project**

The whole rock geochemistry of the selected samples of the intrusive phases from within the mineralized corridor on the Eaglehead project using Na + K versus Si ratios indicates that these rocks are sub-alkalic in nature and exhibit an affinity for Cu-Au (Mo) and Cu-Mo styles of porphyry mineralization Figure 7-6.

## Calc-alkaline and Alkalic Porphyry Types



(Source: Castillo et al. (1999) and Richards and Kerrich (2007))

**Figure 7-6: Calc-alkaline and Alkalic Porphyry Type comparison with the Eaglehead Project.**

### 7.2.3 Quesnel Terrane Lithologies

A general description of the main rock types underlying the Eaglehead project is described below. The distribution of the intrusive phases within the mineralized corridor is shown in Figure 7-8.

### 7.2.4 Hornblende Quartz Diorite (HQDT) (U-Pb Age: $195.090 \pm 0.13$ Ma)

Unit HQDT is the early-stage border phase of the Eaglehead pluton and pinch out northwest of the Camp zone. This unit is present in the Camp, Pass, Bornite, East and Far East zones. The HQDT intrusive phase is dark green, medium-grained, weakly inequigranular and locally weakly porphyritic with plagioclase, quartz, and hornblende phenocrysts. Hornblende is commonly altered to chlorite and feldspar can be altered to sericite. Modal mineral percentage ranges based on field, core, and petrographic observations are:

1. Quartz (1-10%)
2. Plagioclase (45-50%)
3. Hornblende, Biotite, Pyroxene (5-15%)
4. Magnetite (up to 5%)
5. Orthoclase (5-15%)
6. Accessory minerals include apatite, zircon and sphene.

### 7.2.5 Quartz Porphyry (QP) (U-Pb Age: $194.852 \pm 0.098$ Ma)

Previously referred to as the Porphyritic Granodiorite; the Quartz Porphyry is the most abundant phase of the Eaglehead intrusive and initially thought to be the youngest of the major intrusive phases comprising the Eaglehead Intrusive (Gabrielse, 1998).

This unit is the second intrusive phase of the Eaglehead pluton and interpreted to underly the majority of the Eaglehead project. The Quartz porphyry has a slightly higher modal content of orthoclase than the biotite granodiorite and contains rounded (and partially resorbed) quartz phenocrysts (2-5mm typically) set in a finer grained plagioclase/quartz matrix.

Modal mineral percentages ranges based on field, core, and petrographic observations are.

1. Plagioclase (55-60%)
2. Orthoclase (15-20%)
3. Quartz as phenocrysts and matrix (20-25%)
4. Accessory minerals include apatite, magnetite, and opaques.

### **7.2.6 Biotite Granodiorite (BGD)**

The biotite granodiorite is the youngest intrusive phase of the Eaglehead pluton and the main host to the mineralization within the Eaglehead project. It is light grey, phaneritic, medium-grained and equigranular and the biotite and hornblende can attain grain sizes that can be classified as weakly porphyritic. This unit exhibits Unidirectional Solidification Textures (“UST”) evidenced by preferred orientation alignment of euhedral plagioclase, anhedral quartz and subhedral hornblende and biotite phenocrysts (in the East Zone). Modal mineral percentages ranges based on field, core, and petrographic observations are:

1. Plagioclase (55-60%)
2. Perthitic Orthoclase (10-15%)
3. Quartz (20-25%)
4. Biotite and hornblende (1-5%)

Accessory minerals include, magnetite, apatite, sphene and opaques. The primary differences between the quartz porphyry and the biotite granodiorite unit are the quartz porphyry has a slightly higher modal content of orthoclase and distinctive contains rounded (and partially resorbed) quartz phenocrysts (2-5mm typically), though the biotite granodiorite can exhibit mildly porphyritic textures.

The biotite granodiorite exhibits an intrusive contact with the hornblende quartz diorite and a gradational contact with the quartz porphyry indicating that the quartz porphyry magma was still plastic at the time the biotite granodiorite magma was intruded; essentially near synchronous emplacement of the two intrusive phases. The location of the biotite granodiorite between the quartz porphyry and the hornblende quartz diorite supports the interpretation that the biotite granodiorite is the last intrusive phase of the Eaglehead pluton in the central portion of the Eaglehead project area (i.e., youngest) based on field contact relationships.

### **7.2.7 Late-Stage Dikes**

#### **7.2.7.1 QFP – Quartz Feldspar Porphyry Dike:**

This unit is typically pink to salmon color with modal mineral percentages of Quartz 10%, K-Feldspar 70%, as phenocrysts and 20% fine grained quartz K-Feldspar matrix. QFP dikes exhibit a variable thickness (1.0 to 56m core interval), but generally are less than 5.0m. The dikes typically exhibit sharp, well-defined contact with the country rock although gradational contact has been observed in several drillholes as observed in DDH0017. QFP is compositionally like the Quartz Porphyry. Two categories of QFP have been recognized and are described as:

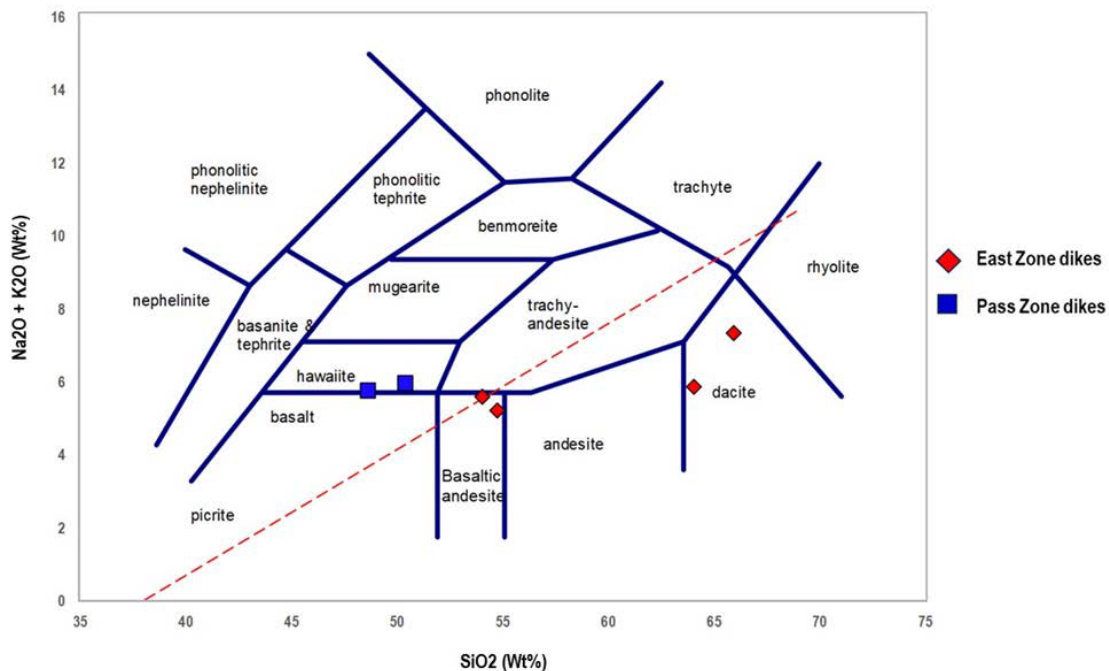
“Crowded” QFP – are typically lighter in color, phenocryst supported in an aphanitic matrix, (often silicious) and consist primarily of euhedral to subrounded K-feldspar phenocrysts and lesser amounts of plagioclase and biotite phenocrysts.

“Sparse” QFP – are typically darker in color, matrix supported, with euhedral to subrounded Quartz and K-feldspar phenocrysts.

Historically, QFP dykes were reported to post-date mineralization; however, recent studies including core re-logging has identified numerous mineralized quartz feldspar porphyry dykes as seen in DDH 125.

### 7.2.7.2 DMAF - Mafic dikes:

Mafic dikes are typically late stage, displays an aphanitic texture, typically dark green in color and in places exhibit chilled contacts with the country rock. The mafic dikes are typically thin (<2m) but can reach thicknesses of up to 5m in places. Mafic dike “swarms” of close spaced, interpreted shallow dipping, thin mafic dikes have been observed in the lower portion of DDH-124 and in outcrop located north of the Eaglehead Camp. In outcrop, the dike swarm strike 068 and exhibit a shallow dip (5-10 degrees) to the north. In places these mafic dikes host plagioclase phenocrysts that imparts a weak porphyritic texture. Whole rock geochemistry indicates that samples of mafic dikes range in composition from Basalt/Hawaiite to Basaltic/Andesite and Dacite. See Figure 7-7.



(Source: Castillo et al. (1999) and Richards and Kerrich (2007))

**Figure 7-7: Classification of mafic dikes from the East and Pass Zones, Eaglehead project. IUGS Classification for Volcanic Rocks.**

### 7.2.7.3 APL – Aplite Dikes

Aplite dikes are typically less than 30 cm thick, are typically fine-grained, aphanitic, and exhibits a saccharine texture (sugary/grainy) containing abundant quartz, potassium feldspar and occasionally

biotite phenocrysts. Occasionally, aplite exhibits locally pegmatitic textures. In certain drillholes, significant intervals (5-15m), aplitic stockwork veining occur.

#### **7.2.7.4 Listwanite:**

Listwanite; a chromium-rich rock (mariposite) occurs in outcrop within a topographic depression referred to as the Cirque approximately 2.5 kms north of the Eaglehead camp. Listwanite is commonly recognized as the product of ankerite (carbonate) hydrothermal alteration of precursor serpentinite. The listwanite outcrop can be traced at least 300 meters along strike, has a width averaging about 5 meters, and dips uniformly 55 to 71 degrees to the southwest. Internally it is strongly deformed, showing porphyroblasts of vein quartz surrounded by isoclinal folded mariposite-ankerite schist. Late, thin ankerite veinlets cut the schist approximately parallel to foliation. Listwanite has been described as part of the Cache Creek Complex west of the south end of Dease Lake (Logan et al., 2011), and in fault zones southeast of Eaglehead between the Turnagain River and Letain Lake (Gabrielse, 1998).

### **7.2.8 Cache Creek Terrane Lithologies - Volcanic and Sedimentary Rocks**

#### **7.2.8.1 Kutcho Assemblage**

Within the Eaglehead project, a narrow wedge of Late Permian to Middle Triassic Kutcho Assemblage rocks lies in structural contact with the Eaglehead pluton on the southwest side of the Thibert fault. To the west it is stratigraphically overlain by sedimentary and meta-sedimentary rocks of the Whitehorse Trough. The Kutcho Assemblage is a heterogeneous package of schists derived from felsic and mafic volcanic and volcanoclastic rocks and associated felsic and mafic intrusions (Thorstad and Gabrielse, 1986). Within the Project, Kutcho Assemblage rocks have been mapped and described by Caulfield as epiclastic and volcanoclastic sediments comprised of shale, carbonate, and sandstone interbedded with conglomeratic and tuffaceous volcanic units. One of the volcanic tuffs is reported to contain 20% pyrite (Caulfield, 1982). These rocks are a component of the Cache Creek Terrane.

#### **7.2.8.2 Whitehorse Trough**

Rocks of the Whitehorse trough occur in a northwest trending belt in the southeastern part of the project area. They are represented by two units: a discontinuous fine-grained limestone unit assigned to the Late Triassic Sinwa Formation and an extensive package of conformably overlying clastic metasedimentary rocks consisting mainly of metasandstone, metasilstone and slate assigned to the Early – Middle Jurassic Inklin Formation within the Cache Creek Terrane. The units have boundaries which lie sub-parallel to the interpreted intrusive contact and near the pluton, dip steeply to the southwest (Gabrielse, 1998).

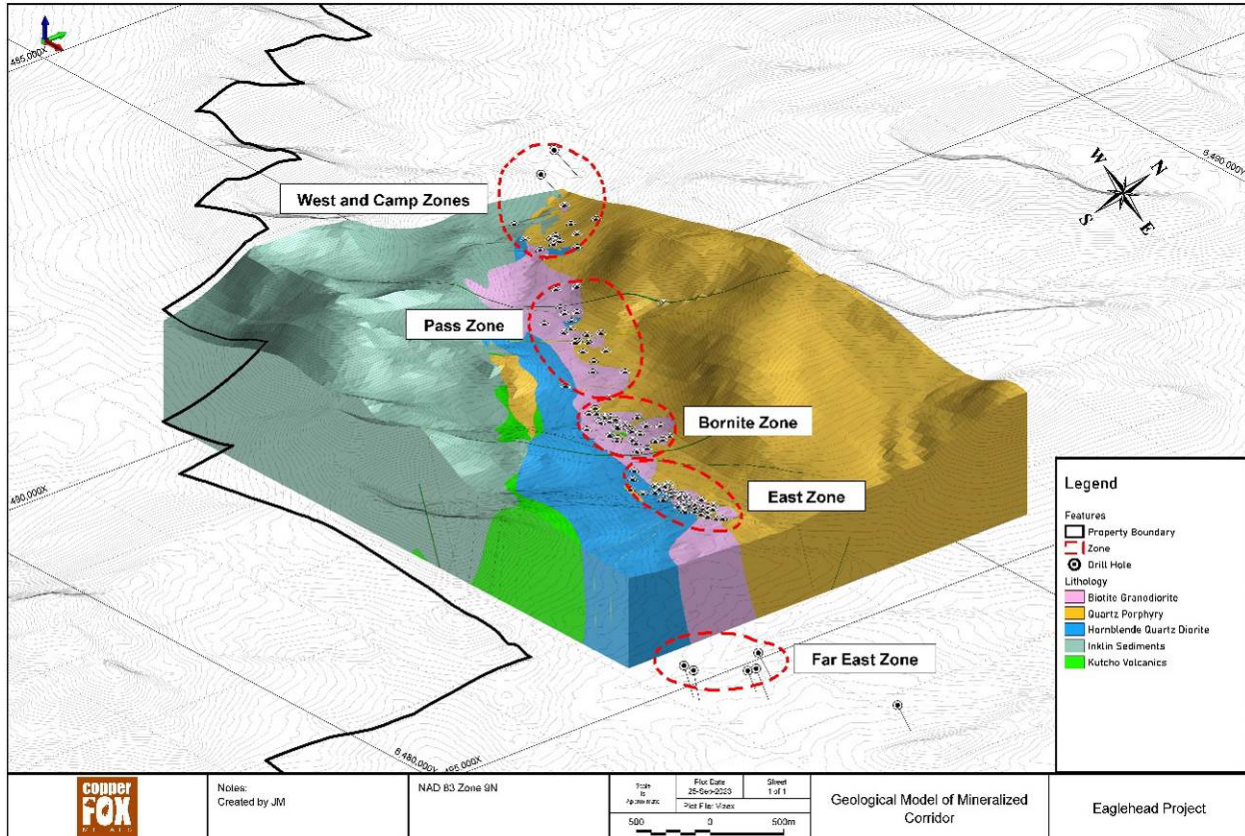


Figure 7-8: 3D model of the geology and Location of Mineralized Zones, Eaglehead Project

### 7.3 Alteration and Mineralization

The geological setting, alteration, and mineralization at Eaglehead is consistent with that of a calc-alkalic porphyry copper-molybdenum system (see Section 8 of this report). The property hosts six zones of Cu-Au-Mo-Ag style mineralization within an 8km long, northwest trending valley (referred to as the “mineralized corridor”). From southeast to northwest these zones are, Far East, East, Bornite, Pass, Camp and West which have been the focus of exploration since the discovery of the Camp zone in 1963. Bedrock exposures of altered and mineralized rock are uncommon primarily due to a thin to thick cover of glacial overburden.

#### 7.3.1 Alteration

Alteration related to the porphyry style mineralization within the mineralized corridor ranges from potassic to phyllic to propylitic, shown in Figure 7-9. Mapping of the alteration zones follows the format provided by Bouzari 2020. A brief description of the main alteration phases is presented below. A general description of the host rocks, dyke activity, alteration, and mineral assemblages by zone to the end of 2022 are shown in Figure 7-2.

**Potassic alteration** (quartz + K-feldspar + secondary biotite, magnetite+/-hematite, calcite), occurs as envelopes around fractures, quartz veins and quartz veinlets (which often contain chalcopyrite and/or bornite), anhydrite veins and pervasive alteration of feldspar. Intense potassic alteration is typically accompanied by chalcopyrite +/- bornite.

**Phyllic alteration** (sericite-chlorite-quartz) is characterized by texturally destructive intense sericitization/chloritization, pale green coloration, silicification and prominent muscovite grains (altered biotite). Fractures and veinlets within this zone can host chalcopryrite-bornite mineralization (commonly vein center) along with a combination of calcite, hematite (after magnetite), sericite and chlorite gangue.

**Propylitic alteration** is characterized by pervasive epidote on edges of plagioclase, epidote veinlets, albite veins, epidote-chlorite veinlets, hematite and pyrite veinlets. Propylitic alteration typically occurs over narrow intervals overprinting the potassic alteration and is overprinted by phyllic alteration.

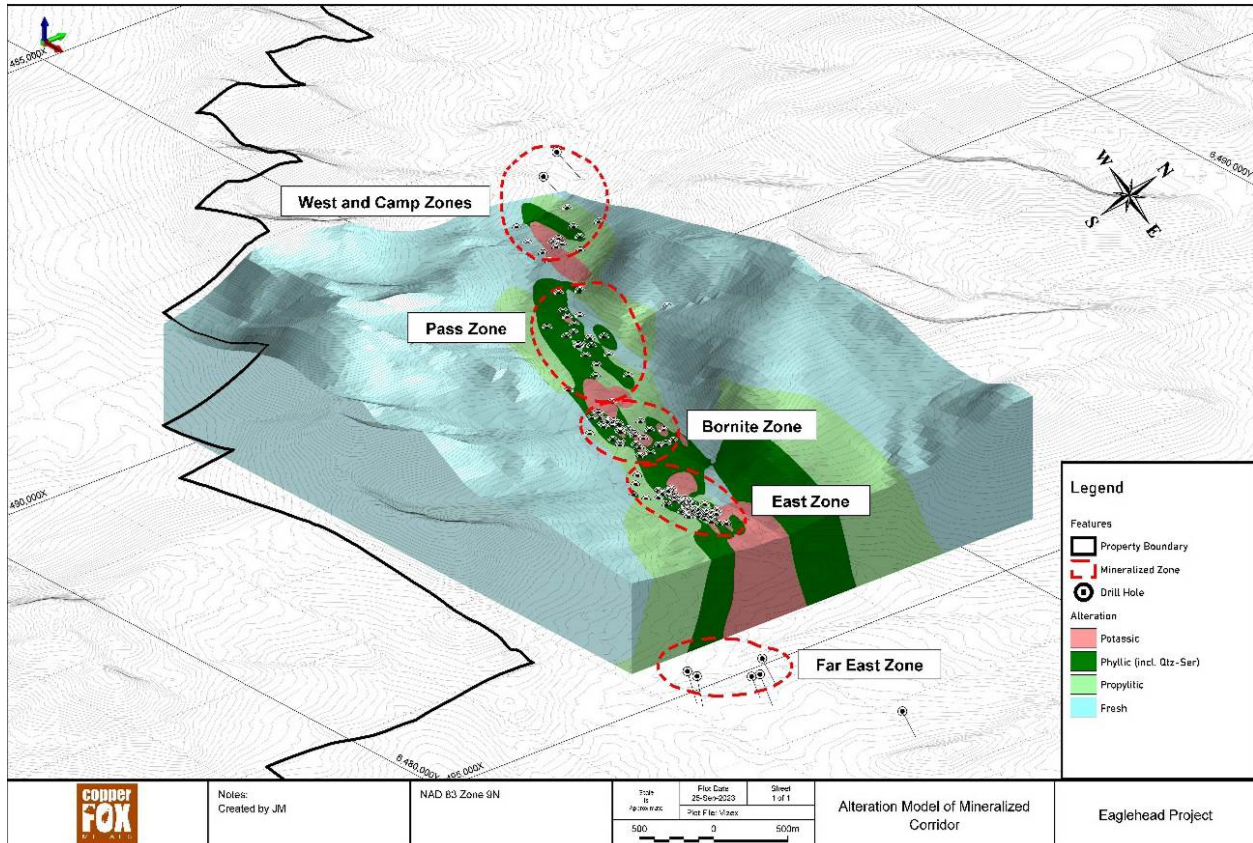


Figure 7-9: Generalized Alteration zonation by mineralized zone; Eaglehead project

### 7.3.2 Mineralization

The porphyry mineralization within the mineralized corridor exhibits a calc-alkaline affinity, that typically hosts copper-molybdenum and gold mineralization. Age dating of the intrusive phases of the Eaglehead pluton indicates crystallization of the older marginal phase hornblende quartz diorite at (195.1+/-0.13Ma) and the younger quartz porphyry at (194.8 +/-0.1Ma). Age dating (Re-Os) of molybdenite mineralization yielded a 194.2 +/- 0.9 Ma. date indicating emplacement of the copper-molybdenum mineralization approximately 500,000 to 700,000 years after crystallization of these phases of the Eaglehead intrusive.

Near surface, oxidization of the primary copper-iron and iron sulphides resulted in the formation of primarily malachite with lesser concentrations of azurite, chrysocolla, secondary chalcocite, limonite, and goethite on fracture surfaces and within quartz veinlets. The depth of oxidization is variable across the mineralized areas and reaches a maximum depth of 194 m in DDH-9.

The copper mineralization (chalcopyrite, bornite with assessor primary chalcocite) is associated with potassic, and texturally destructive sericite-chlorite alteration hosted in crosscutting, multi-phase quartz-sulphide veins, quartz vein stockworks and fractures that can contain significant concentrations of gold-molybdenum-silver. The copper mineralization also occurs as stringers, disseminations, with biotite veins and associated with mafic minerals. Several pulses of copper mineralization are evidenced by early-stage chalcopyrite filled veins cross-cut by later stage chalcopyrite-bornite-pyrite +/- molybdenite veins, quartz chalcopyrite veins and pyrite veins. Late-stage magmatic breccia and brecciated zones exhibiting intense potassic alteration occur in the East, Bornite and Pass zones and contain significantly higher concentrations of copper-molybdenum-gold-silver mineralization as seen in drillholes 69A, 79 and 87.

Copper grade is typically a function of vein/fracture density. Intense, potassic altered late-stage fault related breccia and magmatic breccia typically contain higher concentrations of bornite and molybdenite along with significantly elevated gold and silver concentrations. Molybdenite primarily occurs on shear/fracture surfaces, as matrix in breccia zones, in quartz veinlets and in quartz-anhydrite veinlets.

The updated general mineral paragenetic sequence for the Eaglehead Project is:

1. Early stage: copper (typically over narrow intervals)
2. Second stage: Copper-silver (pervasive)
3. Third stage (copper-gold-molybdenum-silver (may be restricted in extent),
4. Fourth stage copper-gold-silver (restricted in extent),
5. Fifth stage: copper-gold-molybdenum-silver (restricted to intense potassic altered breccia zones and magmatic breccia).

Modelling of the copper shell (0.05% Cu grade cutoff) indicates a northwest strike and moderate to steep dip to the northeast for the mineralization in the bornite and East zones. Surface mapping of copper bearing structures (veins, veinlets, fractures) identified the dominant mineralized trends as N35E +/-90 and N45W dipping 48NE.

Crudely defined sulphide species domains have been recognized in several of the mineralized zones. From the core to the periphery of the mineralized zone, the generalized copper and iron sulphide mineral zonation is: bornite>chalcopyrite, chalcopyrite>bornite, chalcopyrite>pyrite, pyrite>chalcopyrite and pyrite (Stewart, 2016).

The weighted average grade for copper, molybdenum, gold, and silver for the mineralized interval (using a 0.10% copper cutoff) in the East, Bornite, Pass and Camp zones is presented in Table 7-1. The average metal concentrations indicate higher molybdenum concentration to the southeast toward the East zone and higher gold concentrations in the Bornite zone peripheral to the molybdenum.

In the Pass zone, most of the drillholes tested only to a vertical depth of approximately 100m below surface. The mineralization is characterized as copper-silver with scattered relatively narrow intervals of copper-molybdenum-silver and copper-gold-silver mineralization. However, as seen in DDH-16, DDH-125 and DDH-126, the concentrations of molybdenum and gold generally tend to increase with depth.

The Camp zone: also tested to an average vertical depth of 100m below surface is characterized dominantly by copper with scattered silver vales and relatively thin intervals of copper-molybdenum-silver and copper-gold-silver mineralization. Drillhole: DDH-22 is the only drillhole from the Camp zone that intersected significant concentrations of copper-molybdenum-gold-silver over core intervals ranging from 1.7 to 22.5m.



**Table 7-1: Weighted average metal concentrations by zone from Southeast to Northwest, Eaglehead project.**

Zone	Cu (%)	Mo (%)	Au (g/t)	Ag (g/t)
East	0.273	0.013	0.064	0.86
Bornite	0.313	0.007	0.078	1.04
Pass	0.298	0.003	0.024	0.79
Camp	0.296	0.004	0.047	0.72

A summary of the main parameters for each of the mineralized zones within the Eaglehead project is presented in Table 7-2.

**Table 7-2: Summary of Alteration and Mineralization by Zone, from Southeast to Northwest, Eaglehead Project**

Mineralized Zone	Host Rock	Dikes	Alteration Assemblage	Sulphide Mineral Assemblage
Far East	Biotite Granodiorite Hornblende Quartz Diorite  Quartz porphyry	QFP Mafic Aplite	Sericite-chlorite Potassic, Phyllic	Py-Cpy Cpy-Py-Mo Mo
East	Biotite Granodiorite Hornblende Quartz Diorite Quartz Porphyry Kutcho Volcanics	QFP  HBP Aplite Mafic	Potassic  Phyllic  Propylitic Anhydrite veining	Bn-Cpy-Mo  Cpy-Py-Mo  Cpy-Py
Bornite	Biotite Granodiorite Quartz Porphyry Hornblende Quartz Diorite	QFP Mafic	Potassic Phyllic Propylitic Anhydrite veins	Bn-Cpy+/-Mo Cpy-Py Py-Cpy Py
Pass	Biotite Granodiorite Hornblende Quartz Diorite Quartz Porphyry	QFP (crowded) Mafic Aplite	Phyllic-Potassic Late Potassic Propylitic Incl. Anhydrite Veining	Cpy-Py-Bn +/-Mo Qtz-Cpy Py +/- Cpy Py-Hem-Mag
Camp	Biotite Granodiorite Hornblende Quartz Diorite Quartz Porphyry Limestone	QFP Mafic	Potassic Phyllic Late Propylitic	Cpy-Py+/-Bn Bn+/-Mo
West	Biotite Granodiorite	QFP Mafic	Potassic-Phyllic	Cpy-Bn+/-Mo

QFP = Quartz Feldspar Porphyry; HBP = Hornblende Porphyry; HQD = Hornblende Quartz Diorite

## **7.4 Descriptions of Mineralized Zones**

The mineralized corridor hosting the porphyry style mineralization at Eaglehead measures approximately 8kms long by 2-3kms wide located within the Quesnel Terrane near the Thibert Fault system. The mineralized corridor is characterized by a positive chargeability signature, four polymetallic porphyry copper deposits, two zones of porphyry style mineralization and a 6kms long coincident copper-molybdenum in soil geochemical anomaly. The general geology, alteration, and mineralization characteristics of each zone, from southeast to northwest, are described below and are summarized in Table 7-2 (after Stewart, 2022; Quist, 2015; McDonough and Rennie, 2012; Agnerian, 2010). The mineralized intervals from the Far East, East, Bornite, Pass, Camp and West zones are provided in Section 10 of this report. The mineralized intervals do not represent true thickness; the true thickness of each mineralized zone is unknown currently.

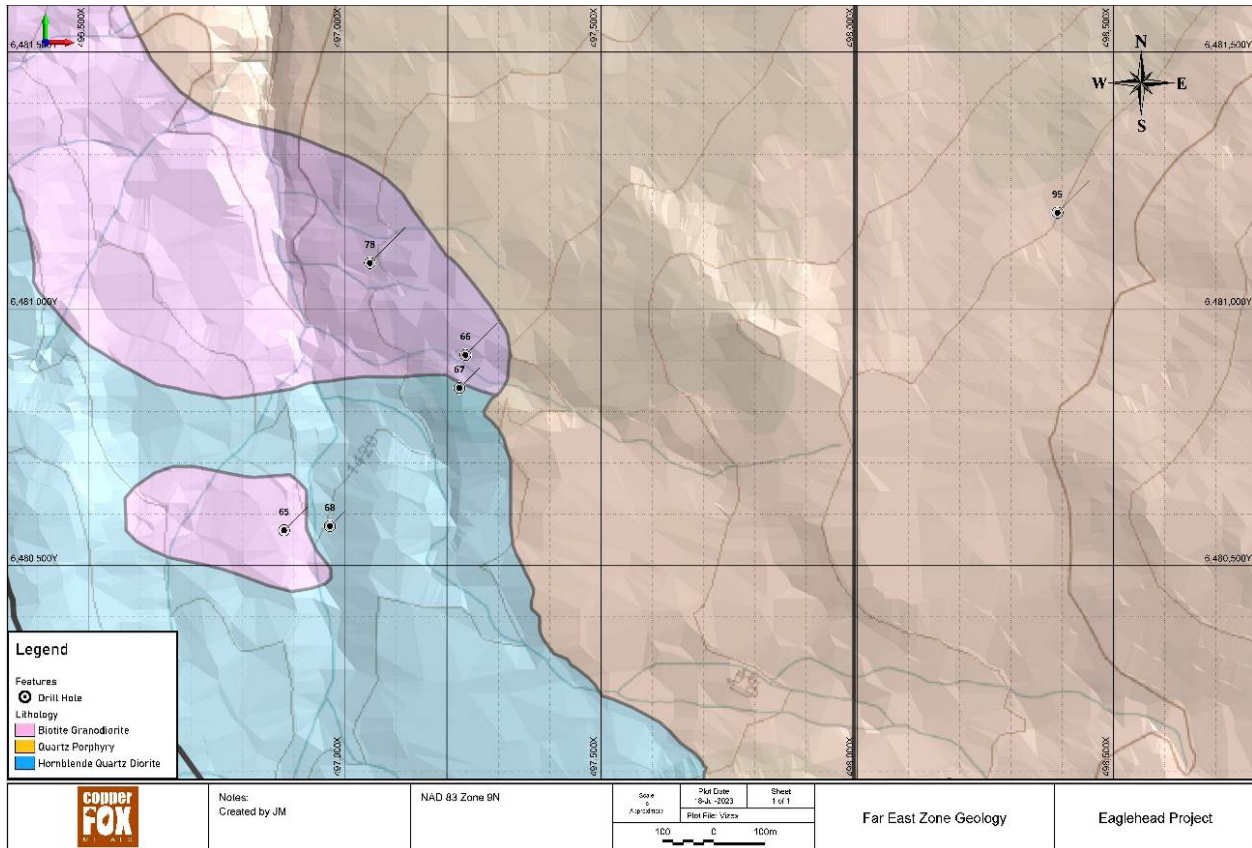
### **7.4.1 Far East Zone**

The Far East zone is located approximately 3kms southeast of the East zone situated along the biotite granodiorite - hornblende quartz diorite - quartz porphyry contact, like that observed in the East zone, Figure 7-10.

The area is covered by overburden and historical exploration identified a coincident copper and molybdenum soil geochemical anomalies and several small, isolated, weak chargeability anomalies in 2005 and 2007. In 2021, a Magnetic Vector Inversion of the 2014 airborne magnetic data identified a strong, circular positive magnetic signature located approximately 1km west of the Far east zone. The top of the magnetic anomaly occurs at an interpreted depth of 100m and is interpreted to represent a potassic altered intrusive plug due to the presence of hydrothermal magnetite.

Initially the Far East zone covered a much larger area. The Far East zone is now defined as the area along the biotite granodiorite-quartz porphyry-hornblende quartz diorite contact shown in Figure 7-10. Historically, eight wide-spaced drillholes were completed to test the weak, positive chargeability anomalies located in 2005 and 2007. Of the eight drillholes, five holes were completed along the biotite granodiorite/hornblende quartz diorite – quartz porphyry contact; two holes were completed to the south along the interpreted Kutcho/Inklin contact and one drillhole (DDH-95) was completed in the quartz porphyry (Figure 7-10).

The interpreted bedrock geology of the Far East zone is shown in Figure 7-10. Late-stage crowded quartz-feldspar porphyry and mafic dikes occur within this zone but are not shown in the Figure.



**Figure 7-10: Interpreted bedrock geology, Far East Zone, Eaglehead project**

The copper mineralization is hosted in biotite granodiorite, hornblende quartz diorite and volcanic units of the Kutcho Formation. Oxidation of primary iron and copper sulphide minerals occur to a depth of 50m.

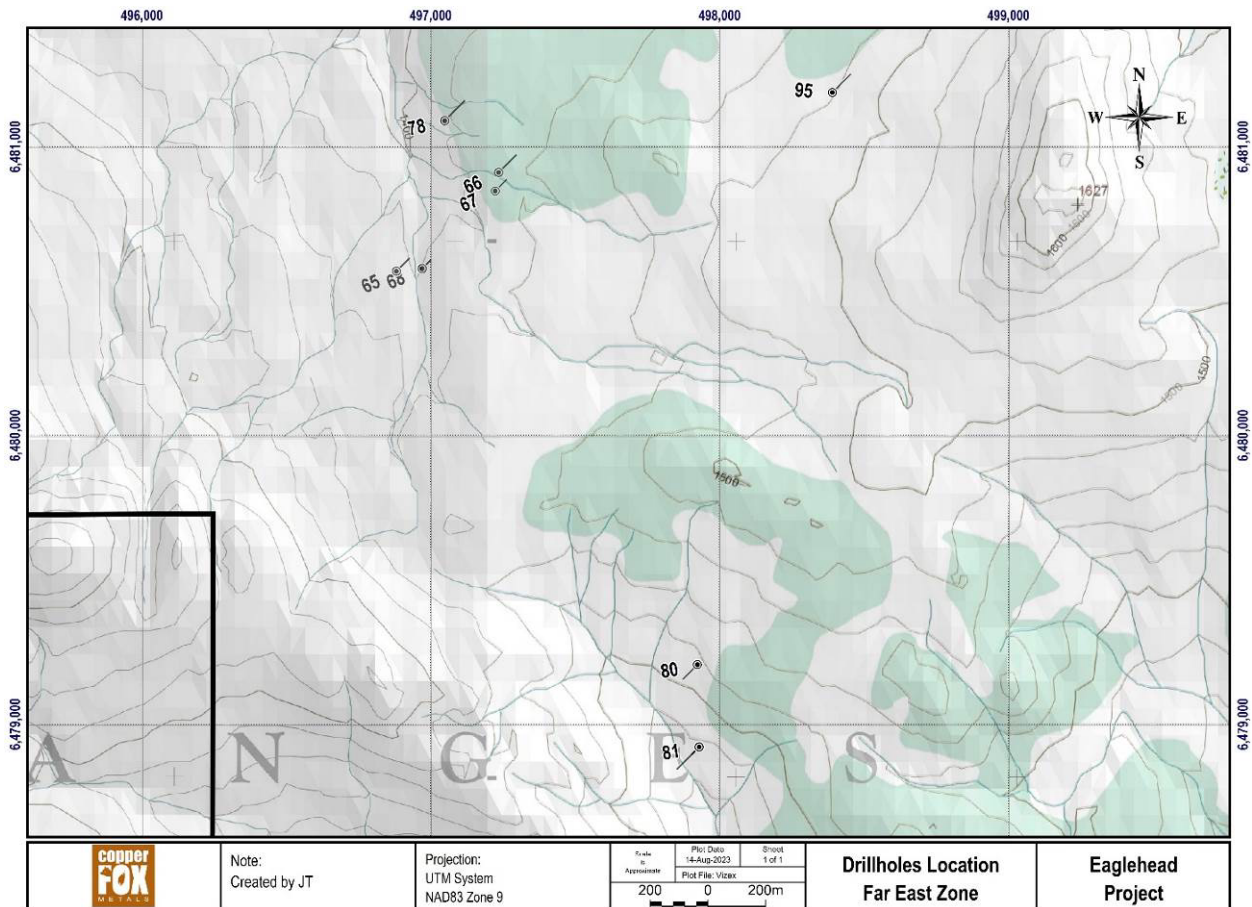
The mineralization occurs as sporadic intervals of weak to moderate concentrations of quartz-chalcopyrite, quartz-chalcopyrite-pyrite and quartz-chalcopyrite-pyrite-molybdenite veins and in fractures throughout the zone. Molybdenite is most prevalent in DDH-66, occurring smeared along fractures and in quartz-molybdenite veinlets. Pyrite is the dominant sulphide and occurs in all drillholes as quartz-pyrite veins, as disseminations and on fractures in association with the copper mineralization. Pyrite content is estimated to be less than 1% on average. Copper and molybdenite concentrations are higher in DDH-66, due to the presence of sporadic, quartz-chalcopyrite-molybdenite-pyrite veins that carry low but significant gold-silver concentrations hosted in the biotite granodiorite.

The dominant alteration in the Far East zone is phyllic (sericite-chlorite) with siliceous intervals as evidenced by the presence of sericite and chlorite veining and the apple green coloration imparted to the drill core. Narrow intervals of early stage potassic alteration evidenced by potassic halos around quartz veinlets and narrow intervals of pervasive potassic alteration of feldspars occur within the phyllic alteration. Propylitic overprinting of the potassic alteration is shown by late-stage cross-cutting epidote veinlets and epidote alteration on the edge of plagioclase.

Significant concentrations of copper-gold-silver along with increased in molybdenum values are hosted in sericite-chlorite altered biotite granodiorite, hornblende quartz diorite and volcanics rock of the Kutcho Formation. Drillhole 66 intersected two distinct styles of mineralization. Sporadic intervals ranging from

0.03 – 3.72m (core interval) characterized by higher-grade copper mineralization (> 1.0 %) with significant concentrations of molybdenum-gold-silver occur within broader intervals of lower-grade copper mineralization (0.1 - 0.4%) containing sporadic low concentrations of molybdenum, gold, and silver. The mineralization generally exhibits a low magnetic susceptibility signature.

The range of metal concentrations within the mineralized intervals for the Far East zone ranges from 0.5 to 40,900 ppm Cu, 0.09 to 458 ppm Mo, 0.005 to 1,22g/t gold and 0.02 to 79.10 g/t Ag. Weighted average grades for mineralized intervals in the Far East zone range from 0.11 – 2.08% Cu and mineralized intervals range from 0.12 – 31.45m in core length. See Section 10 for tabulated intervals. Drill locations are included in Figure 7-10 and Figure 7-11.



**Figure 7-11: Drillhole Locations, Far East Zone, Eaglehead Project**

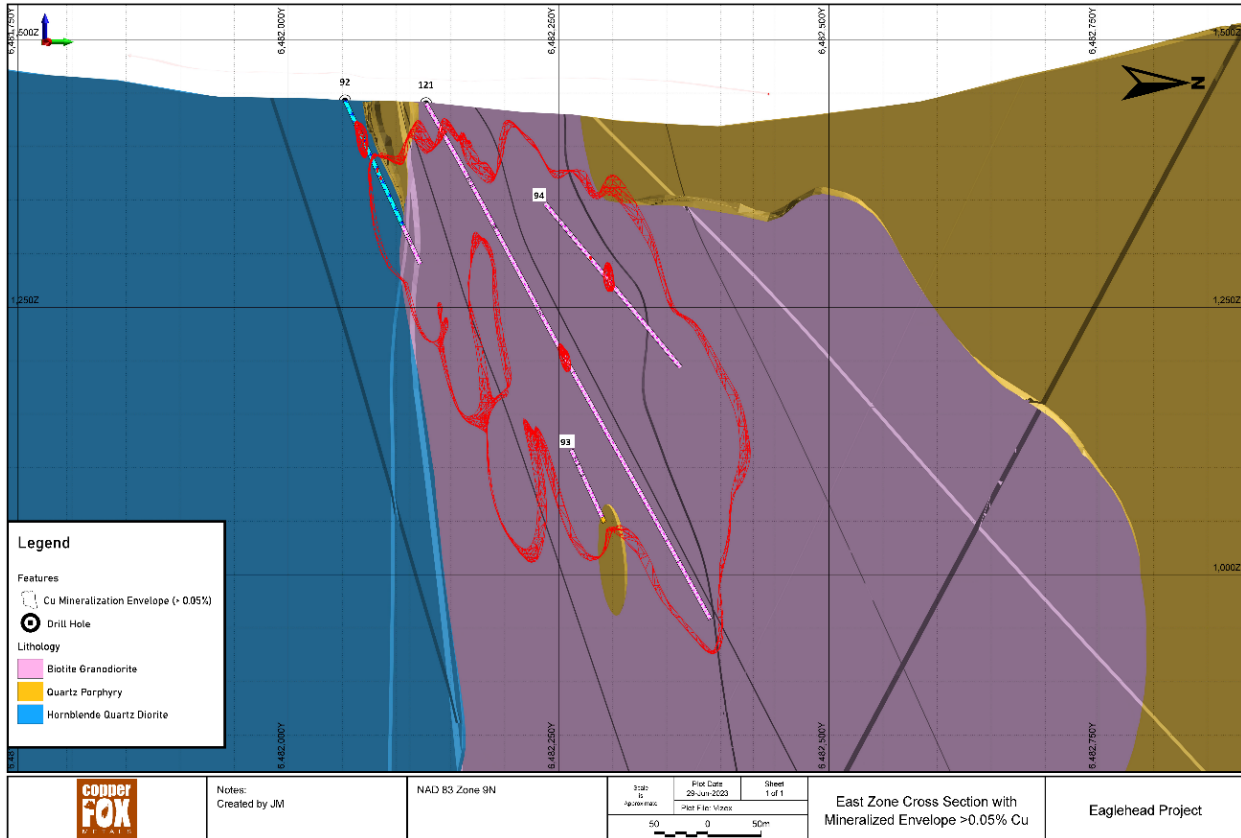
## **7.4.2 East Zone**

Centered approximately 3km northwest of the Far East zone, the East zone is interpreted to be essentially a continuation of the Bornite zone with similar style of porphyry mineralization, alteration and metal associations. The zone is underlain primarily by biotite granodiorite with lesser amounts of quartz porphyry, hornblende quartz diorite, late-stage quartz feldspar porphyry, Mafic and Aplite dikes. Whole rock analyses of four selected samples of mafic dikes show that two of the dikes are of basaltic/andesitic composition and two of the samples are of dacitic composition. Quartz feldspar porphyry dikes are more abundant toward the northern portion of the zone as observed in DDH 108 and DDH109.

Weathering and oxidization resulted in the transformation of chalcopyrite and bornite to malachite-azurite-chalcocite all secondary copper minerals to vertical depths of up to 40m below surface.

Modelling of the mineralized envelope in the East zone using a 0.05% Cu cutoff indicates the mineralization extends approximately 750m along strike, is up to 450m wide, extends to a depth of approximately 500m and dips steeply to the north (Figure 7-12). The mineralization is open to the west toward the Bornite zone, to the south and at depth to the north (Figure 7-12). Figure 7-12 shows a cross-section (495000E) of the lithologic units in relation to the copper envelope across the central portion of the East zone.

The mineralization is primarily hosted in biotite granodiorite with lesser amounts in quartz porphyry, hornblende quartz diorite and in some but not all, thin (1-3m) quartz feldspar porphyry dikes. The mineralization in portions of the East zone outcrops below the overburden.



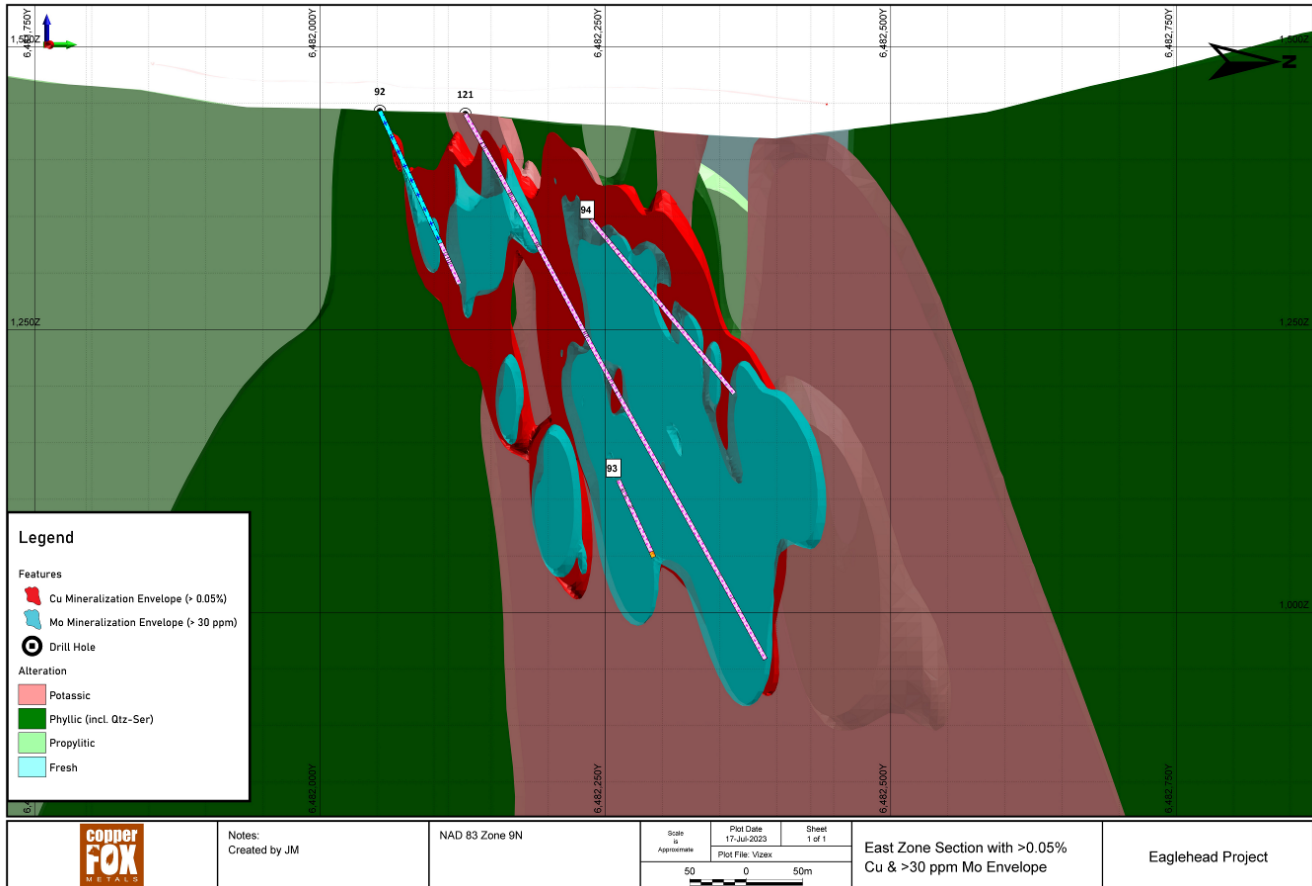
**Figure 7-12: Representative geological cross-section of the East Zone at approximately 495000E (Section NE-SW) with corresponding mineralization.**

The East zone is characterized by a central core of potassic alteration transitioning outward to a pyrite deficient (<0.5%) zone of phyllic (Sericite-Chlorite) followed by an outer zone of propylitic alteration, (Figure 7-13). The early stage potassic alteration is evidenced by pervasive K-Feldspar flooding, K-Feldspar veins, K-Feldspar envelopes around quartz veins, quartz veinlets and mineralized fractures. In places, hydrothermal (secondary) biotite occurs associated with quartz-chalcopyrite veining. Late stage intense potassic (K-spar) alteration occurs within late-stage magmatic breccia and brecciated zones. Fracture and vein density appears to be the main control on intensity of potassic alteration.

Texturally destructive, Phyllic alteration (Sericite-Chlorite) is evidenced by the light green coloration imparted to the host rocks, sericite-muscovite mineralogy, sericite halos on quartz veins and quartz veinlets, and presence of both sericite and chlorite veinlets. Phyllic alteration is observed to overprint the potassic and propylitic alteration.

Narrow intervals of propylitic alteration occur throughout the East zone evidenced by epidote alteration of plagioclase, epidote veinlets, epidote coating fractures, albite rims on plagioclase and albite veinlets. Hydrothermal albite, as a product of this early propylitic alteration, is found ubiquitously associated with calcite, epidote, and chlorite in veinlets. Pervasive sericitic alteration has obliterated all traces of earlier propylitic alteration in certain of these veins.

Localized, intervals of anhydrite veining occur at deeper levels within the East zone. A generalized model of the alteration zonation associated with the porphyry style mineralization in the East zone is shown in Figure 7-13.



**Figure 7-13: Distribution of alteration zonation and copper/molybdenum shell along approximately 495000E (NE-SW) of the East zone, Eaglehead project.**

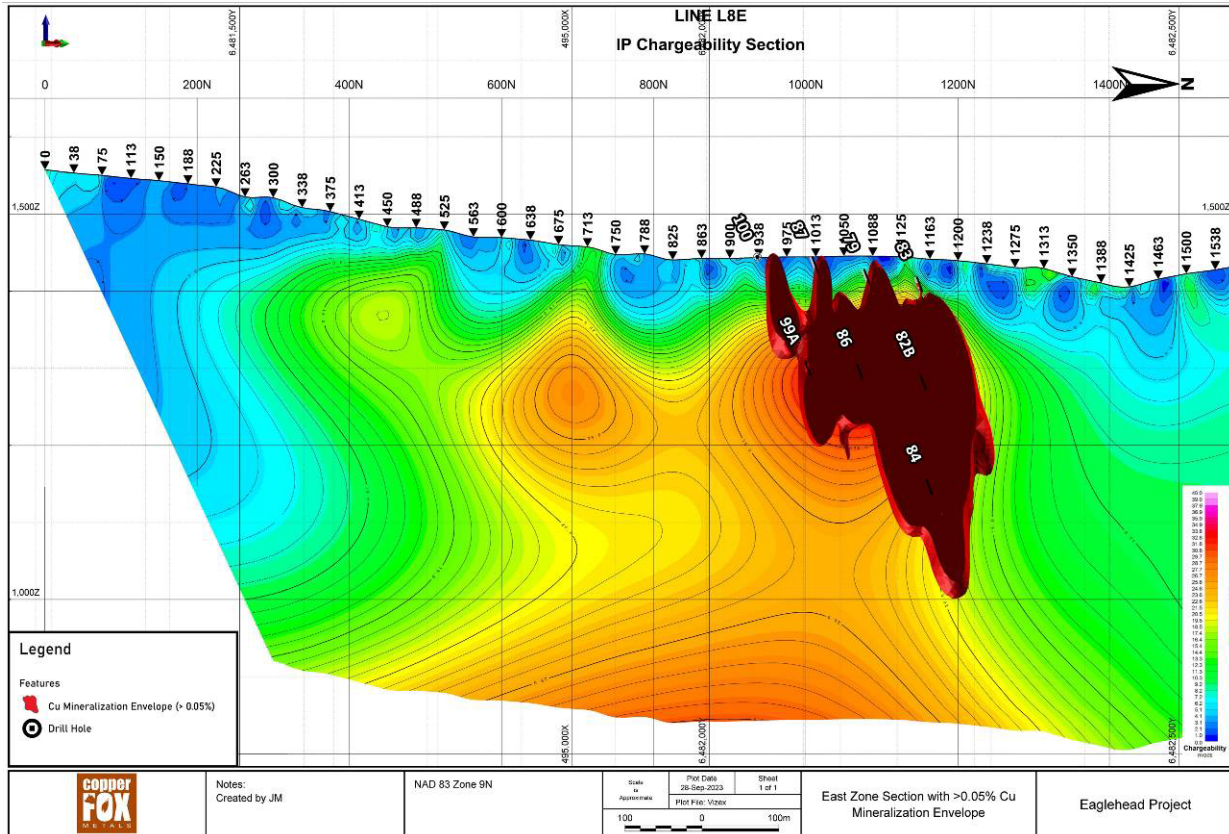
East of section 495350, within the East zone, the potassic alteration is abruptly terminated over a 50m horizontal distance; all drillholes east (+/- 40m) of this section exhibit weak to moderate phyllic alteration enclosing weak patchy potassic alteration. Detailed re-logging of the drillholes from within this area indicates that the biotite granodiorite in DDH 97 and DDH 98 is coarser grained, contains larger quartz phenocrysts and intersected significant intervals of gouge, crushed, intensely fractured and broken core than the biotite granodiorite intersected in DDH-96 located approximately 50m to the west. DDH-98 intersected an intensely bleached, fault zone (56.0 to 129.0m) with intense clay alteration overprinting earlier phyllic alteration. In drillholes 97 and 98, pyrite occurs over the entire length of these holes and occurs at the top of the hole (15-41m) and from 227 to 325m (EOH) in DDH 96. Figure 7-14 shows the distribution of potassic and phyllic alteration in DDH 107 from within the East zone.

The copper mineralization exhibits a strong spatial correlation to the chargeability and resistivity signatures identified by ground based geophysical surveys (Figure 7-15). Based on the spatial correlation and the modelling of the mineralized envelope, the mineralization is open to the west toward the Bornite zone, to the south and at depth to the north.



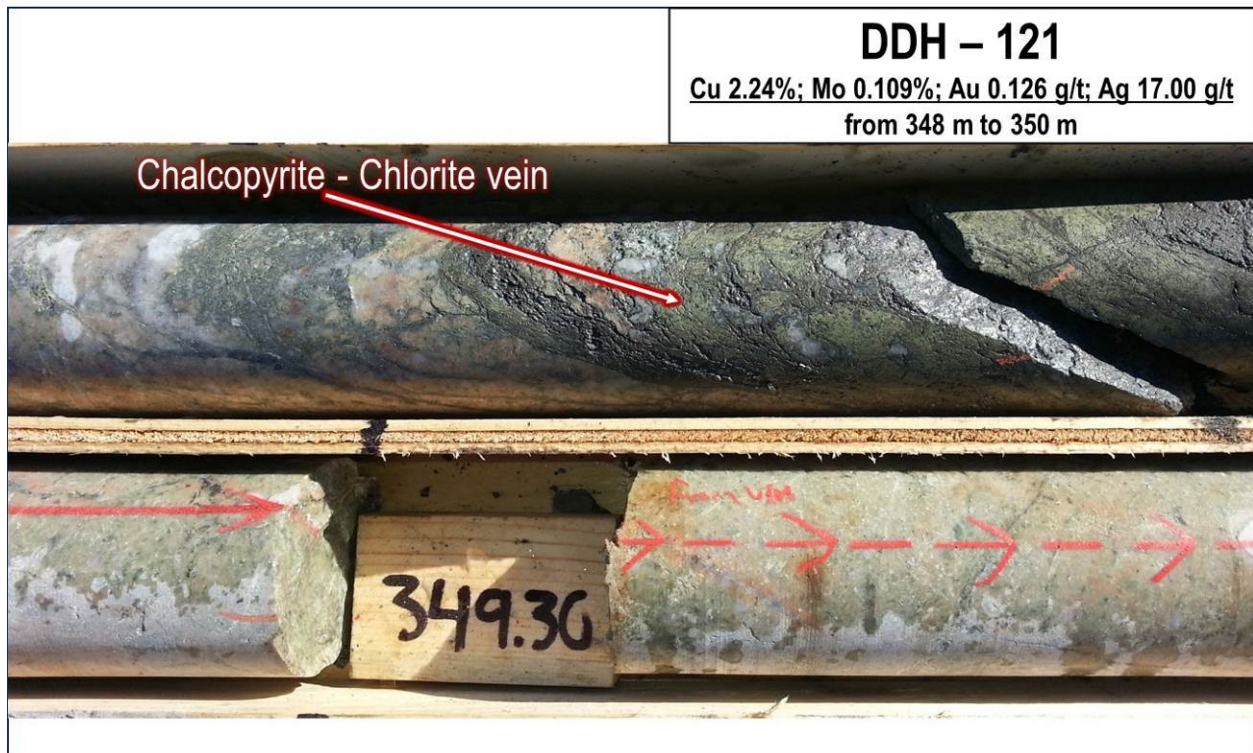
**Figure 7-14: Mixed Potassic (k-feldspar) and Phyllic (sericite) Alteration, East zone, DDH 107, centered at 194.0 m (Lane, 2019)**





**Figure 7-15: Copper shell superimposed on the 2014 Quantec geophysical chargeability signature - Approximate Section 495000E (NE-SW).**

The copper mineralization (chalcopyrite-bornite) occurs primarily as fracture and vein fillings with lesser concentrations in quartz veins, quartz veinlets stockwork, stringers, disseminations, in biotite veins and associated with mafic minerals (Figure 7-16). The copper mineralization is associated with potassic, and texturally destructive sericite-chlorite alteration hosted in crosscutting, multi-phase quartz-sulphide veins and quartz vein stockworks that contain significant concentrations of gold-molybdenum-silver. Several pulses of copper mineralization are evidenced by early-stage chalcopyrite filled veins cross-cut by later stage chalcopyrite-bornite-pyrite +/- molybdenite veins, quartz chalcopyrite veins and pyrite veins. An example of cross-cutting relationships of quartz-chalcopyrite +/- molybdenite veins are shown in Figure 7-17 from DDH 107 in the East Zone. Late-stage magmatic breccia and fault related brecciated zones exhibiting intense potassic alteration occur throughout the East zone and contain significantly higher concentrations of copper-molybdenum-gold-silver mineralization as seen in drillholes 69A, 79 and 87.



**Figure 7-16: Chalcopyrite mineralization with associated mafics in the East Zone**

The distribution of molybdenite is more restricted in extent and primarily occurs in quartz-molybdenite and quartz-molybdenite-anhydrite veins and veinlets, in quartz-chalcopyrite-bornite-pyrite-molybdenite veins and veinlets and along slippage planes and in minor shear zones.

Pyrite has a wider distribution than the copper mineralization and occurs mainly as fracture and vein filling and in quartz vein and quartz veinlet associated with copper sulphides. Pyrite also occurs as disseminations and associated with mafic minerals. The pyrite content across the East zone is estimated based on visual estimates to range from 0.1 to 3.0 % averaging 0.4%, with specific narrow interval estimated to contain up to 20% pyrite as seen in DDH-90. The highest pyrite concentrations are recorded on the southern portion of the zone and decreasing significantly toward the northern portion of the zone.

Fracture and vein hosted hematite and disseminated, vein and fracture-controlled magnetite accompany the porphyry mineralization in the East zone. Petrographic studies indicate that nearly all the primary magmatic magnetite has undergone hypogene oxidation to hematite (martite). Hypogene oxidation has been identified as a key process in the genesis of porphyry copper deposits having higher-than-average hypogene copper grades (cf. Brimhall, 1980).

In general, the mineralized intervals exhibit a low (<1.0) magnetic susceptibility with a few intervals of mineralization exhibiting moderate (3.0-8.0) magnetic susceptibility.

The East zone is characterized as a copper-molybdenum-gold-silver style of mineralization and contains the highest overall molybdenum concentrations. The concentrations of molybdenum-gold-silver can vary significantly with the copper mineralization. The higher concentrations of molybdenum occur in a northeast trending zone that measures approximately 100m wide by 200m long (open to the northeast)

located at the eastern end of the East zone. Overall higher molybdenum-gold concentrations typically occur in the deeper parts of the drillholes in the East zone. Sulphide mineralization displays the following generalized mineral zonation:

1. A bornite-chalcopyrite-molybdenite core
2. A chalcopyrite-pyrite intermediate zone
3. A pyrite-chalcopyrite outer halo
4. Outer pyrite shell (<<1% Py)

The range of metal concentrations within the mineralized intervals for the East zone ranges from 0.5 to 99,700 ppm Cu, 0.05 to 17,700 ppm Mo, 0.005 to 42.91g/t gold and 0.02 to 98.49 g/t Ag. Weighted average grades for mineralized intervals range from 0.10 – 3.45% Cu and mineralized intervals range from 1.30 – 245.08 m in core length. See Section 10 for tabulated results. Drillhole locations for the East zone are shown in Figure 7-18.



**Figure 7-17: Close-up of Core Displaying Two Orientations (parallel to core axis and at 30° to core axis) of Quartz-chalcopyrite±molybdenite veinlets (with potassic halo), East Zone, DDH 107 at 194.2m (Lane, 2019)**

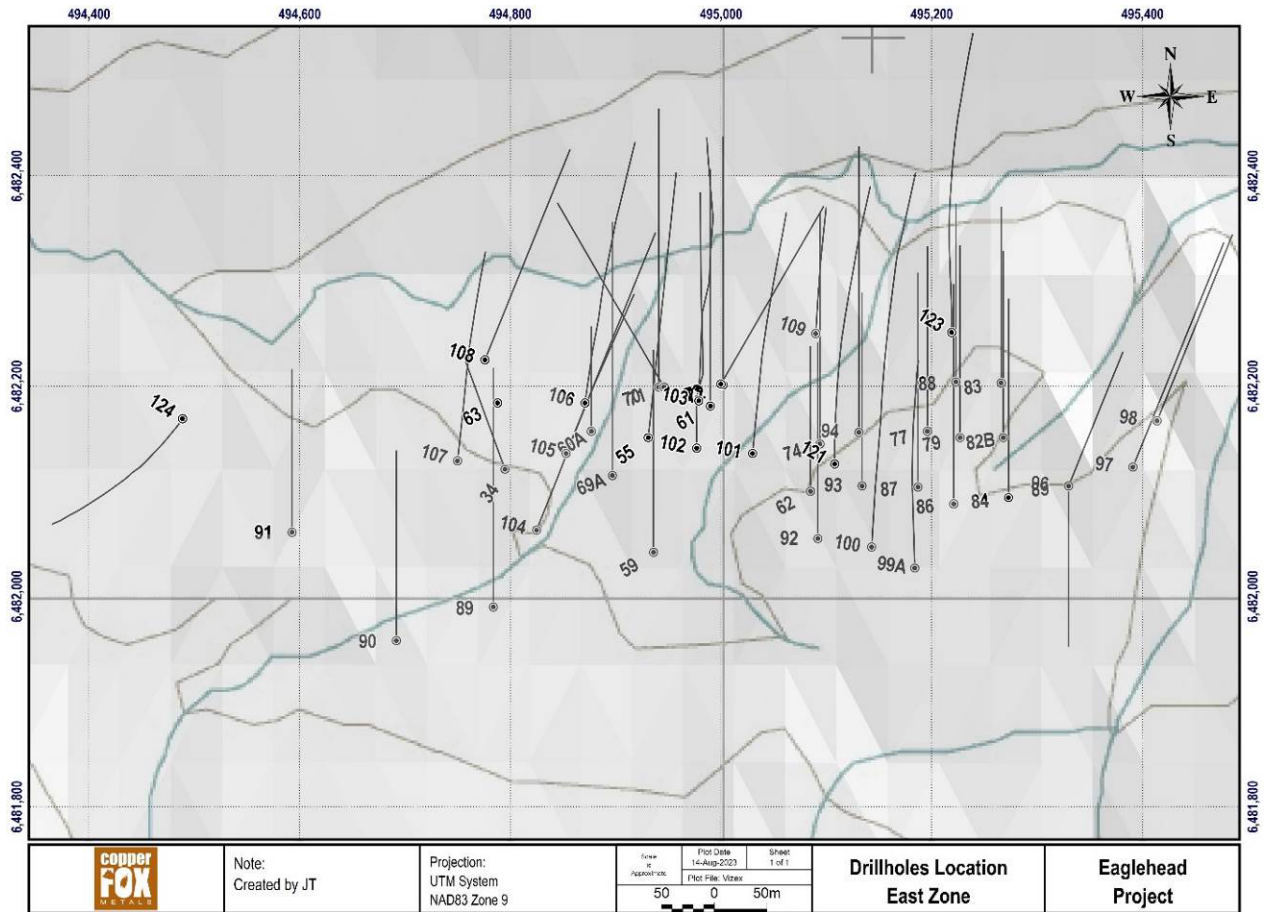


Figure 7-18: Drillhole Locations, East Zone, Eaglehead Project

### 7.4.3 Bornite Zone

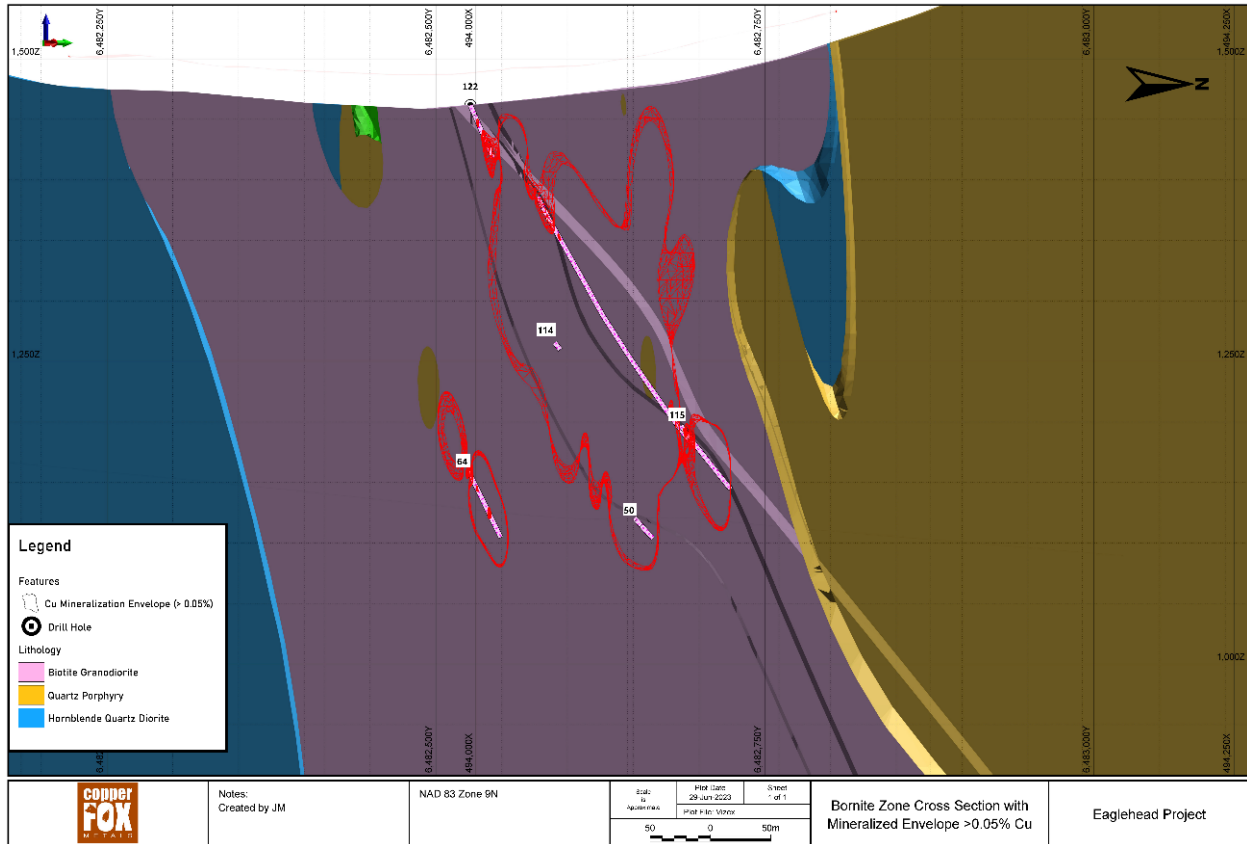
The Bornite zone is located approximately 400m northwest of the East zone and is interpreted to be essentially a continuation of the East zone with similar porphyry styles of mineralization, alteration, and metal associations. Together with the East zone, it has been the focus of the majority of exploration drilling completed to date on the Project.

The zone is underlain primarily by biotite granodiorite with lesser amounts of quartz porphyry, and hornblende quartz diorite. These units have been intruded by both crowded and sparse quartz feldspar porphyry dikes ranging in thickness up to 35m and mafic dikes that are typically from 1-5m in thickness.

Weathering and oxidization resulted in the transformation of chalcopyrite and bornite to malachite-azurite-chalcocite all secondary copper minerals to a maximum vertical depth of 169.16 below surface as seen in DDH 19. The average vertical depth of the oxidization is 58m based on data from all drillholes within the zone.

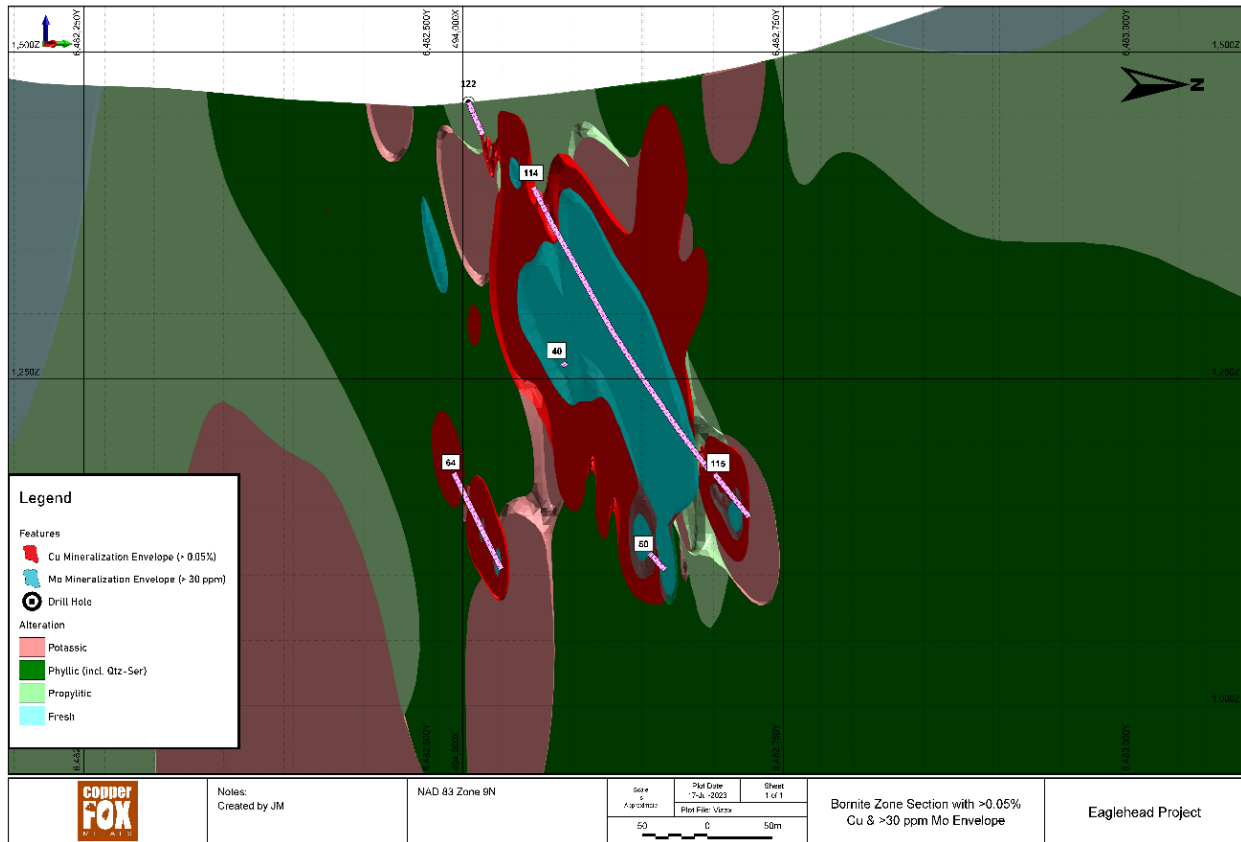
Modelling of the mineralized envelope using a 0.05% Cu cutoff, the mineralization has a strike length of approximately 750m, an interpreted width of 450m, extends to a vertical depth of 350m below surface and dip steeply to the north (Figure 7-19). Mineralization in several areas of the zone remains open to the north, to the east (towards the East zone) and at depth.

The mineralization is primarily hosted in biotite granodiorite with lesser amounts in quartz porphyry and quartz feldspar porphyry dikes. The quartz feldspar porphyry dikes in the Bornite zone exhibit a higher frequency and increased apparent thickness compared to the East zone as observed in DDH-50. Not all quartz feldspar porphyry dikes in this zone are mineralized. The mineralization in portions of the Bornite zone is exposed immediately below the overburden.



**Figure 7-19: Bornite Zone Cross Section with Mineralized Envelope >0.05% Cu. Section 494000E (NE-SW)**

The Bornite zone is characterized by a restricted central core of potassic alteration transitioning outward to a pyrite deficient (<1% Py) zone of pervasive phyllic (Sericite-Chlorite) alteration. A generalized model of the alteration associated with the porphyry style mineralization in the Bornite zone is shown in Figure 7-20. Early stage potassic alteration is evidenced by K-Feldspar flooding, K-Feldspar veins, K-Feldspar envelopes around quartz veins, quartz veinlets, mineralized fractures, secondary biotite, and magnetite veins. Late stage intense potassic alteration occurs within late-stage magmatic breccia and structural breccia.



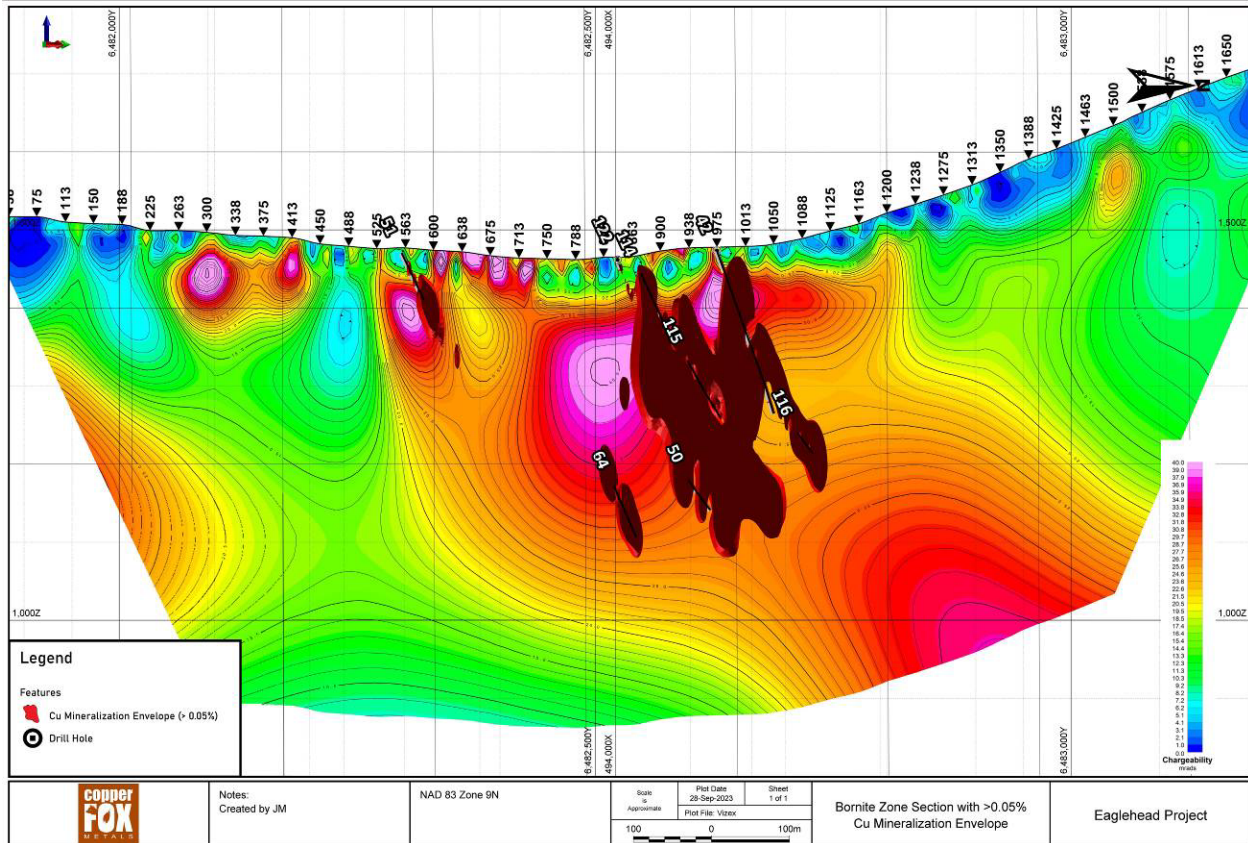
**Figure 7-20: Generalized alteration model in relation to copper/molybdenum shells, Bornite Zone, Section 494000E (NE-SW).**

Texturally destructive phyllic alteration (sericite-chlorite +/-quartz) is evidenced by the light green coloration imparted to the host rocks, sericite-muscovite mineralogy, sericitic haloes to quartz vein and quartz veinlets and presence of both sericite and chlorite veinlets. Phyllic alteration is observed to overprint the potassic and propylitic alteration.

Narrow intervals ranging from 5-30m (core intervals) of propylitic alteration evidenced by epidote alteration of plagioclase, cross-cutting epidote veinlets, epidote coating fractures calcite veins albite rims on plagioclase, albite veinlets and sporadic pyrite veins occur within the potassic and phyllic alterations zones. Pervasive later stage sericitic alteration has obliterated all traces of earlier propylitic alteration in many of the albite veins.

Localized, narrow intervals of anhydrite veining occur at deeper level within the Bornite zone.

The copper mineralization exhibits a strong spatial correlation to the chargeability and resistivity signatures identified by ground based geophysical surveys Figure 7-21. Modelling of the mineralized envelope indicates that the mineralization is open to the east toward the East zone, to the West toward the Pass zone, to the south and at depth to the north.



**Figure 7-21: Interpreted Copper shell superimposed on Quantec geophysical chargeability signature). Approximate Section 494000E (NE-SW)**

The copper mineralization (chalcopyrite-bornite) is associated with potassic, and texturally destructive sericite-chlorite alteration hosted in crosscutting, multi-phase quartz-sulphide veins and quartz vein stockworks that can contain significant concentrations of gold-molybdenum-silver. Several pulses of copper mineralization are evidenced by early-stage chalcopyrite filled veins cross-cut by later stage chalcopyrite-bornite-pyrite +/- molybdenite veins, quartz chalcopyrite veins and pyrite veins. Late-stage magmatic breccia and brecciated zones exhibit intense potassic alteration and contain significantly higher concentrations of copper-molybdenum-gold-silver mineralization as seen in DDH 114 and DDH-122.

The copper concentration appears to be directly related to fracture intensity, abundance of quartz veins-quartz veinlets and degree of rock alteration. The copper and iron sulphide mineralization displays a generalized mineral zonation and is recognized as:

1. A bornite-chalcopyrite-molybdenite core
2. A chalcopyrite-pyrite intermediate zone
3. A pyrite-chalcopyrite outer halo
4. A pyrite shells.

The mineralization in the Bornite Zone occurs mainly in quartz-chalcopyrite-bornite-pyrite +/- molybdenite veinlets, quartz-k-spar-chalcopyrite-bornite-pyrite veins and quartz-chalcopyrite-bornite veins. Magmatic breccias typically contain higher grades of copper-molybdenum-gold-silver mineralization as observed in DDH-116 and DDH-122.

Chalcopyrite and bornite are the most abundant copper sulphide species and occurs mainly in quartz veins (Figure 7-22) and veinlets (center filling) along with lesser amounts as fine to medium-grained disseminations, blebs, stringers in either calcite or anhydrite veinlets, on fractures, in breccia zones and associated with mafic minerals and in biotite veinlets. The higher concentrations of chalcopyrite and bornite tend to occur in areas of more intense structural preparation, such as fault breccia, increased fracture density, quartz stockwork and magmatic breccia. The copper mineralization exhibits a positive copper-magnetite-hematite association.

Molybdenum (>30 ppm) is more restricted in extent than the copper mineralization and generally occurs along the southern portion of the Bornite zone. Molybdenite is primarily fracture controlled but can also occur along shear surfaces, in quartz veinlets, anhydrite veinlets, in magmatic breccia and brecciated zones. On occasion molybdenite is associated with chalcopyrite in quartz veinlets. Molybdenum concentrations are highly variable but in general are more restricted and of lower concentration than seen in the East zone. Mineralized intervals with higher molybdenum and gold concentrations generally occur at depth.

Pyrite has a wider distribution than the copper mineralization and occurs mainly as fracture and vein filling and in quartz veins and quartz veinlets associated with copper sulphides. Pyrite also occurs as disseminations and associated with mafic minerals. The pyrite content across the Bornite zone based on visual estimates ranges from 0.1 to 2.0 % averaging 0.25%.

The copper and gold appear to show a good correlation whereas the relationship between copper and molybdenum is more variable.

The concentrations of molybdenum-gold-silver can vary significantly with the copper mineralization. Higher concentrations of molybdenum occur at surface in drillholes DDH-122 and DDH-120. Overall higher molybdenum-gold concentrations typically occur in the deeper parts of the drillholes in the Bornite zone.

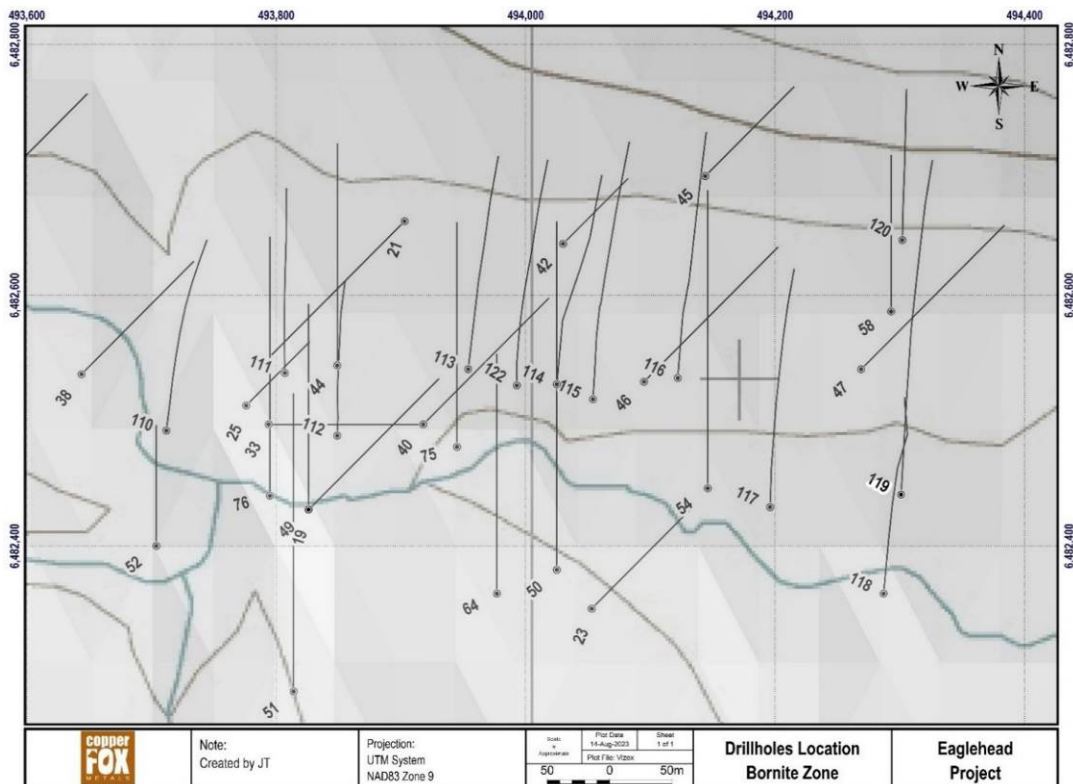
The weighted average grade of the mineralized intervals (0.10% Cu cutoff) in the Bornite zone are shown in Section 10 of this report. Drillhole locations for the Bornite zone are shown in Figure 7-23.





(Source: Lane, 2019)

**Figure 7-22: Bornite-chalcopyrite mineralization within intensely potassic altered zone, Bornite Zone, DDH 74 at 315.0m**



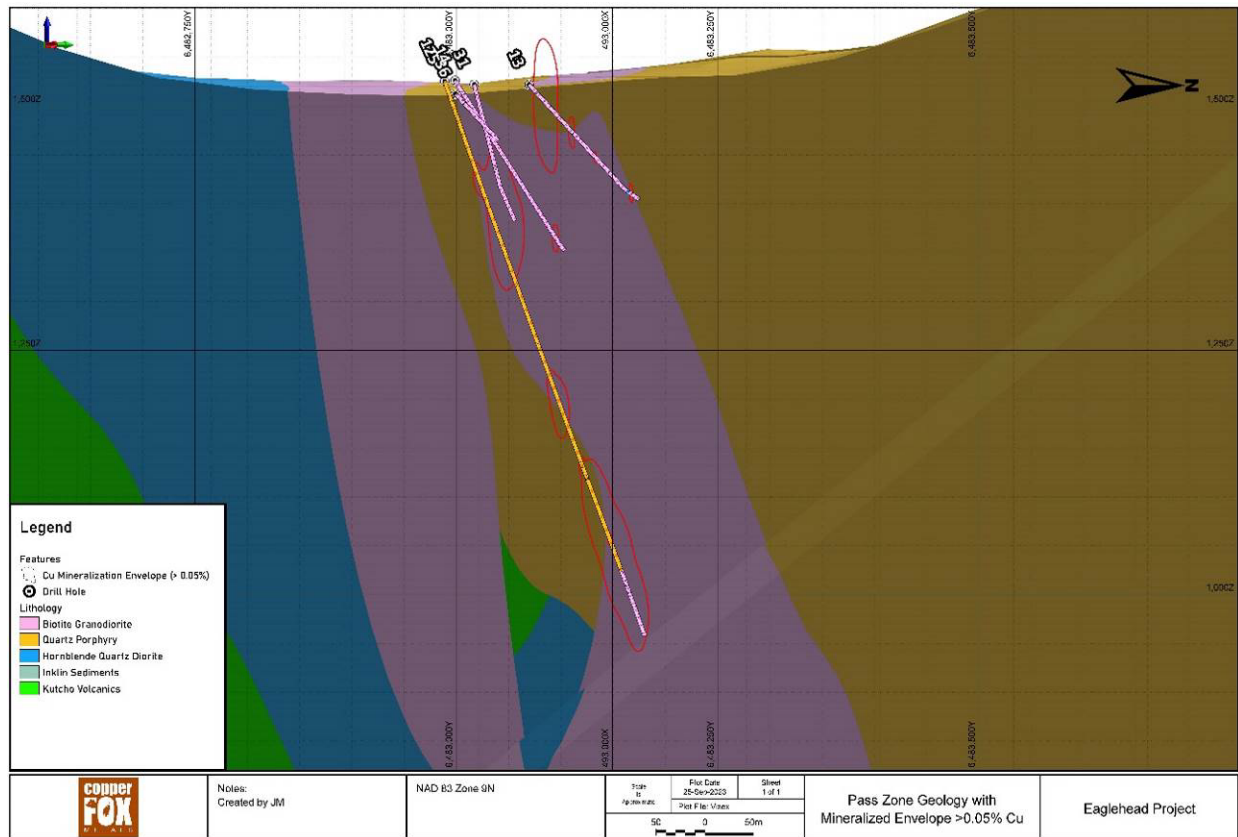
**Figure 7-23: Drillhole Locations, Bornite Zone, Eaglehead Project**

### 7.4.4 Pass Zone

The Pass zone is located approximately 500m northwest of the Bornite zone and is underlain by biotite granodiorite, quartz porphyry and hornblende quartz diorite, intruded by sparse quartz feldspar porphyry, hornblende quartz diorite, and mafic dikes. Whole rock analyses of select samples of the mafic dikes indicates that the samples are of basaltic/hawaiite composition (refer to Figure 7-7 above). The mineralization extends over a strike length of 1,500m, appears to dip steeply to the north (70° to 80°) and consists of pinching and swelling en echelon mineralized intervals extending to a depth of 609m below surface in drillhole 125. Drillholes 16 and 125 were terminated in mineralization.

The depth of weathering/oxidization of the primary sulphide mineralization extends to a vertical depth of approximately 150m as evidenced by the presence of malachite/azurite at a core interval of 194m in DDH 35.

The mineralization in portions of the Pass zone is exposed immediately below the overburden as seen in DDH-48. Figure 7-24 shows a cross-section (493000E) showing distribution of lithologic units in relation to the copper envelope across central portion of the Pass zone. Modelling of the mineralized envelope using a 0.05% copper cutoff suggests a steep dip of the mineralization to the north (Figure 7-24).



**Figure 7-24: Generalized geology with superimposed copper shell (0.05% Cu cutoff) Pass zone. Approximate Section 493000E (NE-SW)**

The porphyry mineralization consists of chalcopyrite and pyrite with traces of bornite and molybdenite occurring within intervals of moderate to strong potassic and phyllic-altered biotite granodiorite, hornblende quartz diorite and quartz feldspar porphyry dykes hosted in crosscutting, multi-phase quartz-

sulphide veins and quartz vein stockworks that contain significant concentrations of gold-molybdenum-silver. Several pulses of copper mineralization are evidenced by early-stage chalcopyrite filled veins cross-cut by later stage chalcopyrite-bornite-pyrite +/- molybdenite veins, quartz chalcopyrite veins and pyrite veins that exhibits a spatial correlation to magnetite and hematite. Intervals of higher-grade copper mineralization are characterized by late stage, potassic alteration and bornite.

Drillholes 125 and 126 provide the best representation of the alteration, mineral zonation, and copper-molybdenum-gold silver concentrations in the Pass zone.

Bornite occurs in DDH 13, DDH125, DDH 17, DDH 48 and 126 and is most abundant at the bottom off these drillholes. The bornite occurs in quartz-chalcopyrite-bornite-pyrite-molybdenite veins and in quartz chalcopyrite-bornite veins and veinlets. The most consistent zones of bornite mineralization occurs in the deeper parts of Drillholes 125 and 126 where it occurs with broad intervals of continuous chalcopyrite mineralization and overlaps intervals of molybdenite mineralization.

Chalcopyrite accompanied by variable concentrations pyrite is the most abundant copper sulphide species. Chalcopyrite occurs in association with the bornite bearing veins and as quartz-chalcopyrite-pyrite veins and veinlets and as quartz-chalcopyrite veins and veinlets and occurs mainly as veinlets and vein center filling along with lesser amounts as fine to medium-grained disseminations, blebs, stringers in either calcite or anhydrite veinlets, on fractures, in breccia zones and associated with mafic minerals and in biotite veinlets. See Figure 7-25 for an example of mineralization in a breccia. The higher concentrations of chalcopyrite and bornite tend to occur in areas of more intense structural preparation, such as faults, brecciated zones, increased fracture density and in quartz stockwork. Copper mineralization exhibits a positive copper-magnetite-hematite association.



(Source: Lane, 2019)

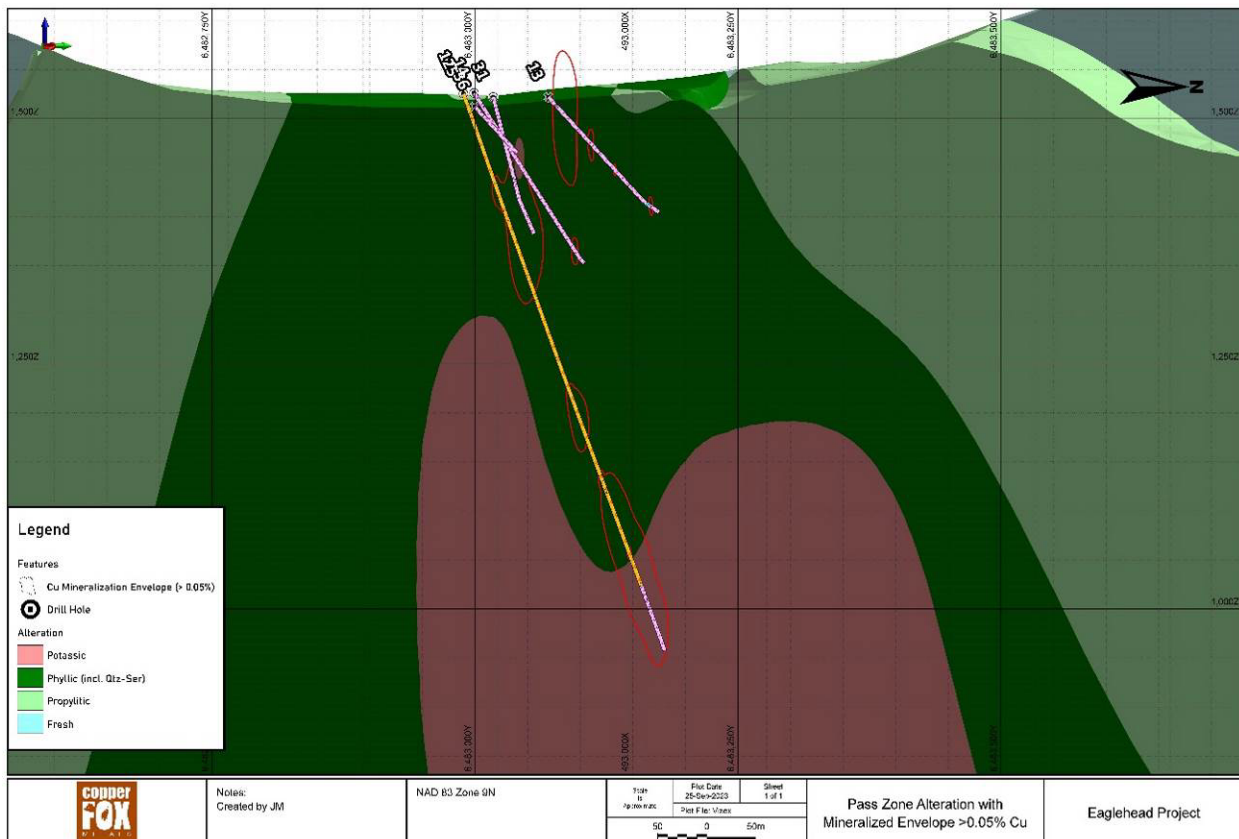
**Figure 7-25: Hydrothermal (magmatic) Breccia: Intergrown Chalcopyrite-pyrite as Matrix to Sub-rounded Clasts of Potassic-altered Intrusive Rock, Pass Zone, hole 53 centered at 70.0m**

Visible Molybdenite is rare and where present occurs in quartz-molybdenite and quartz-molybdenite-anhydrite veinlets. Molybdenite mineralization is more restricted in extent than the copper mineralization. Molybdenite (>30 ppm) is primarily fracture controlled but can also occur along shear surfaces and associated with quartz-chalcopyrite-bornite-pyrite-molybdenite veins and breccia zones. On occasion molybdenite is observed associated with quartz-chalcopyrite veinlets. Molybdenum concentrations are highly variable but in general are more restricted in extent and of lower concentration than seen in either the Bornite or East zone. Mineralized intervals with higher molybdenum and gold concentrations generally occur toward the bottom of DDH 16 and 126 and at the bottom of DDH125. Molybdenum concentrations are in general low (<30ppm) apart from molybdenum concentrations exceeding 0.009% Mo over a 176m core interval in DDH 126 and 0.012%MO over a core interval of 90m at the bottom of DDH 125.

Pyrite content is variable within specific drillholes and across the zone. Pyrite exhibits a broader distribution than copper mineralization and based on visual estimates averages 0.4% and in specific drillholes ranges from 0.05 to 3%. Pyrite occurs primarily in quartz-pyrite veinlets (1-3mm) as disseminations and stringers (fractures) and associated with copper sulphides in quartz veins and quartz veinlets and mafic minerals. In DDH-126, the interval from 12.19m to 132.0m does not contain either

copper-iron or iron sulphide minerals and the interval from 132m to the end of the holes at 575m averaged 1.0% pyrite. In contrast DDH125, the pyrite content from 21.49m to 213m is estimated to average 0.9% pyrite and the interval from 231m to 493m is estimated to average 0.3%. The core interval from 493m to the end of the hole at 606m contains significant copper and molybdenum mineralization but no pyrite. The majority of the other drillholes in the Pass zone contains pyrite over the entire core interval.

A generalized model of the alteration zonation associated with the porphyry style mineralization in the Pass zone is shown in Figure 7-26. Potassic alteration is limited in extent and occurs mainly as pervasive K-Feldspar flooding, K-Feldspar veins, K-Feldspar envelopes around quartz veins, quartz veinlets and mineralized fractures as well as hydrothermal biotite and magnetite veins. In DDH 125 and DDH 126, the intensity of the potassic alteration increase toward the bottom of these drillholes with the introduction of secondary biotite accompanying the K-spar alteration.



**Figure 7-26: Generalized alteration zonation and copper shell (0.05% Cu cutoff) on Section 493000E (NE-SW), Pass zone, Eaglehead project.**

Phyllic alteration (sericite-chlorite-quartz) is widespread and is the dominant alteration present within the Pass zone. This alteration overprints the potassic alteration and is primarily evidenced by the light green coloration imparted to the host rocks, sericite-muscovite mineralogy and presence of sericite, chlorite and pyrite veinlets and widespread disseminated pyrite.

Narrow intervals ranging from 3-10m (core intervals) of late stage propylitic alteration evidenced by epidote alteration of plagioclase, cross-cutting epidote veinlets, epidote coating fractures calcite veins

and irregular pyrite filled fractures and veinlets occur within the potassic and phyllic alterations zones. See Figure 7-27 for an example of weak propylitic alteration.



(Source: Lane, 2019)

**Figure 7-27: Weak Propylitic Alteration, Biotite Hornblende Granodiorite, Pass Zone, hole 48 at 131.4m**

Intensity of sulphide mineralization is directly related to fracture intensity, abundance of quartz veins and quartz veinlets and intensity of rock alteration. The Pass zone is characterized by copper-silver mineralization with sporadic narrow intervals of molybdenum (>30 ppm) and gold (>0.10g/t). Narrow (<4m core length) intervals of higher-grade copper-molybdenum-gold-silver mineralization occur with the copper-silver mineralized shell. In general, molybdenite-gold concentration tend to increase with depth in several drillholes as seen in DDH 125 where the core interval 516.0 to the end of the hole at 606.0m returned a weighted average of 0.21% Cu, 0.012% Mo, 0.12 g/t Au and 0.12 g/t Ag over a core interval of 90m. This hole ended in mineralization.

Weighted average grades for mineralized intervals in this zone range from 0.10 – 0.798% Cu and mineralized intervals range from 12.0 - 231.0m in core length. See Section 10 for tabulated interval results. Drillhole locations for the Pass zone are shown in Figure 7-28.

The copper exhibits a good correlation to silver whereas the relationship between copper, molybdenum and gold is more variable.

The Pass zone contains lower overall molybdenum and gold concentrations than the Bornite and East zones. The concentrations of molybdenum-gold-silver can vary significantly with the copper mineralization. The mineralized zones roughly parallel the alteration assemblages, resulting in following generalized associations:

1. A bornite-chalcopyrite zone with potassic alteration.
2. A chalcopyrite-pyrite zone with phyllic alteration.
3. A pyrite-chalcopyrite zone with propylitic alteration.

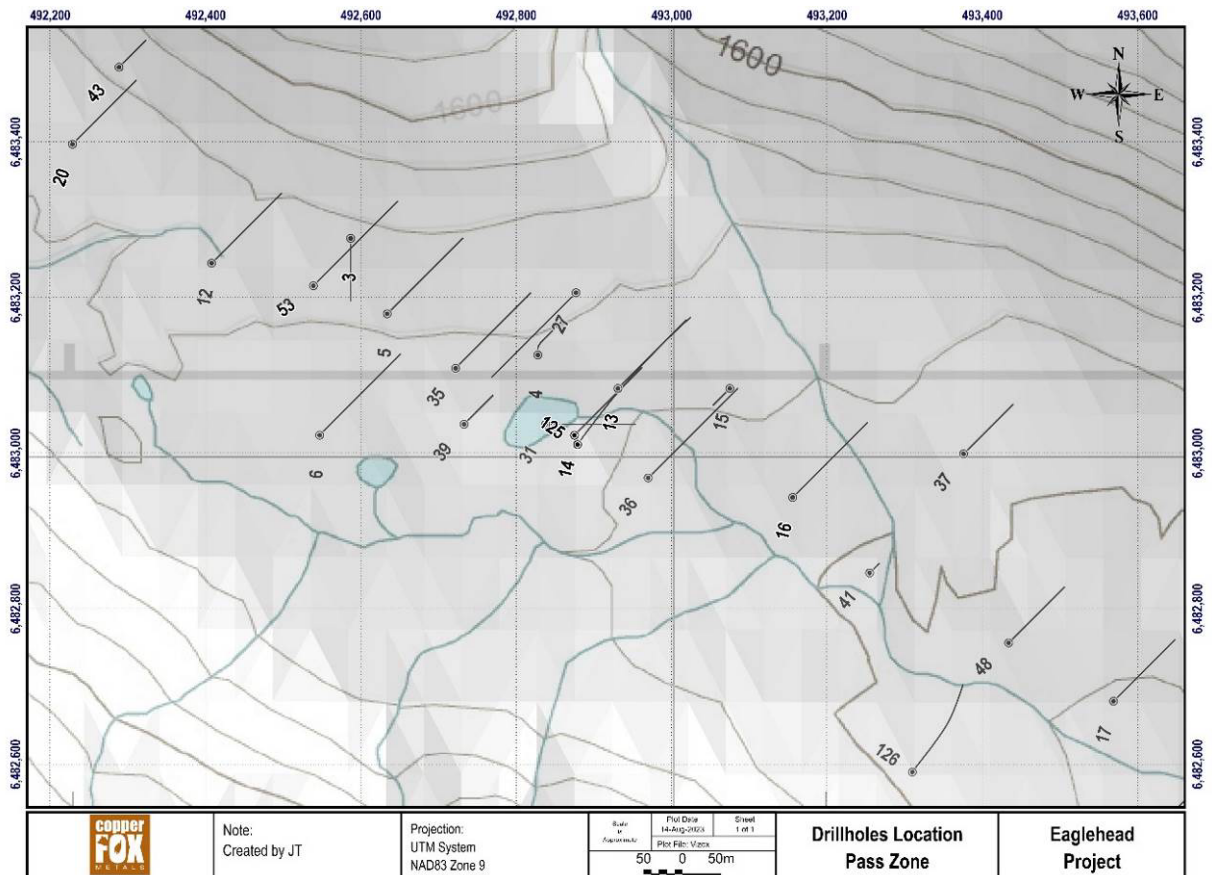


Figure 7-28: Drillhole location map, Pass Zone.

Intervals of significant gold mineralization (>0.03 g/t) are sporadic and normally where present; occur with significant copper mineralization. The most consistent interval of higher-grade gold mineralization occurs at the bottom of DDH 125 that returned a weighted average of 0.12g/t gold over a core interval of 90m from 516.0 to 606.0m (EOH). This drillhole was stopped in mineralization.

No direct correlation between the copper-molybdenum-gold mineralization has been observed.

#### **7.4.5 Camp Zone**

The Camp zone is located approximately 800m northwest of the Pass zone. Copper mineralization with minor concentrations of molybdenum, gold and silver has been intersected in wide spaced (100 - 300m) drillholes over a strike length of approximately 800m, over a width of up to 400m and to a maximum depth of approximately 230m below surface.

The depth of weathering/oxidization of the primary sulphide mineralization extends to a depth of approximately 47m as evidenced by the presence of malachite/azurite at a core interval of 197m in DDH 9.

This zone is underlain by biotite granodiorite, quartz porphyry, hornblende quartz diorite, limestone, crowded and sparse quartz feldspar porphyry and late stage mafic and pegmatitic aplite dykes.

The mineralization is hosted in biotite granodiorite, quartz porphyry and hornblende quartz diorite associated with pervasive strong to intense texturally destructive phyllic and localized moderate potassic alteration. The potassic alteration is restricted in extent and occurs as K-spar halos on quartz-chalcopyrite veins, K-spar veins, and weak K-spar overprinting of feldspar. Phyllic (sericite-chlorite-quartz) alteration is the dominant alteration and consists of moderate to strong variable concentrations of sericite-chlorite-silica and quartz-pyrite veinlets. Narrow intervals of sericite-chlorite alteration impart a light apple-green coloration to the core. Narrow intervals of weak propylitic alteration have also been observed evidenced by the presence of epidote (1-2mm) and pyrite-epidote veins.

The metal zonation for the Camp zone is generally Py>Cpy except for DDH-9 where the metal zonation is mainly Cp>Py. The copper mineralization (chalcopyrite +/- bornite) occurs in 1-2 mm thick quartz-chalcopyrite veins, quartz-bornite veins, quartz-chalcopyrite-pyrite veins, quartz-chalcopyrite-molybdenite veins, in quartz stringers and as fine to medium-grained disseminations, stringers, fractures and associated with mafic minerals within the altered intrusive rock.

Pyrite is ubiquitous throughout the zone and occurs as pyrite veins, quartz-chalcopyrite-pyrite veins and as fine to medium-grained disseminations, stringers, and fractures. Based on the lack of systematic data, the estimated pyrite content of the Camp zone cannot be provided.

Significant molybdenite was observed in DDH-22 and DDH-26 in quartz-chalcopyrite-molybdenite veins, quartz-molybdenite veins and as fracture coatings in core. The zone, based on drilling and surface mapping, is interpreted to have a strike length of approximately 1,200m.

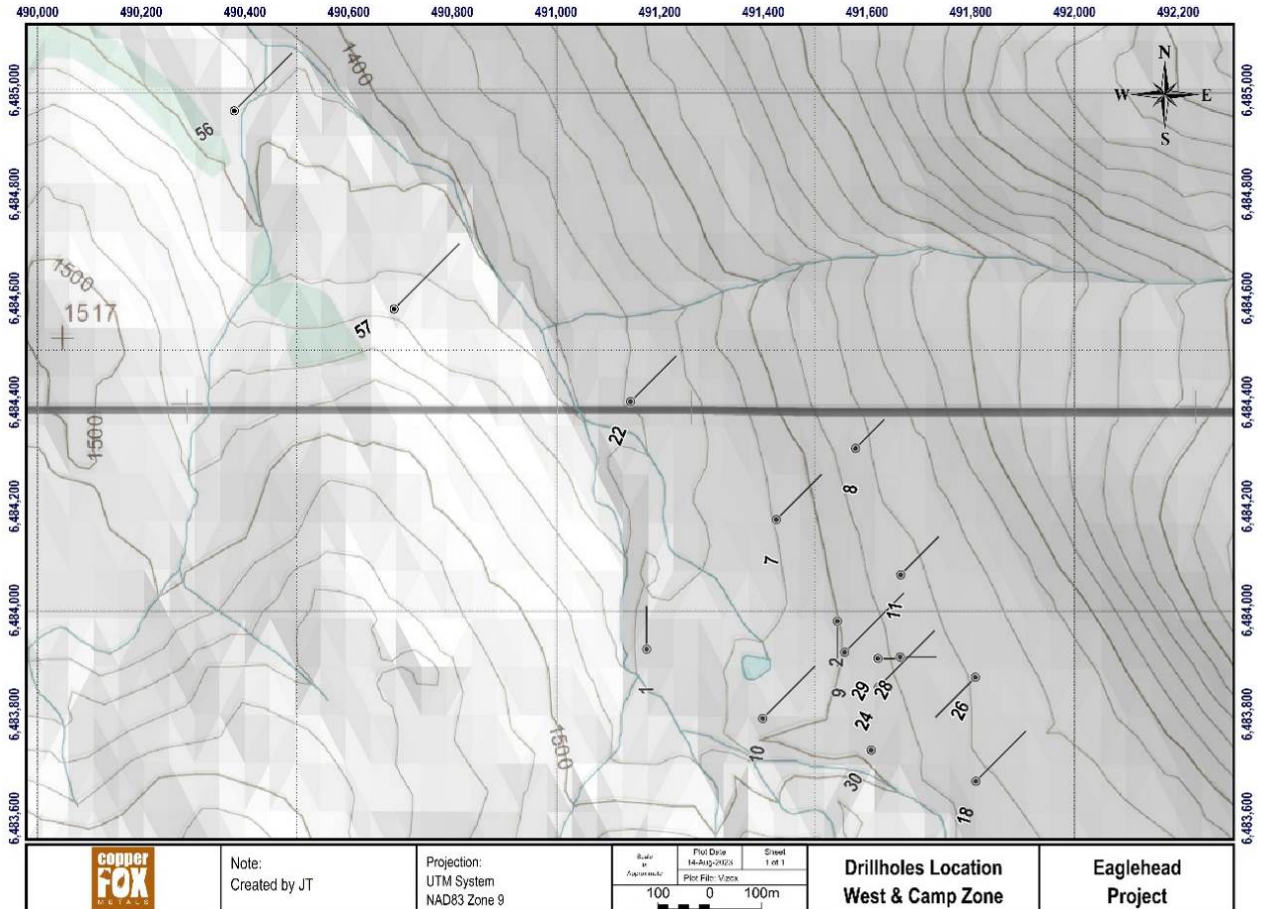
Weighted average grades for mineralized intervals in this zone range from 0.131 – 0.688% Cu and mineralized intervals range from 1.5 – 133.07 in core length. Metal concentrations ranges are copper 16.5 to 14,500 ppm; Molybdenum from 0.5 to 1,050 ppm, gold from <0.005 to 0.545 g/t and silver <0.02 to 5.50g/t.

The weighted average grade for the mineralized intervals in the Camp zone are shown in Section 10 of this report. Drillhole locations for the Camp zone are shown in Figure 7-29.

Mapping in the vicinity of the Camp zone in the early 1970's located outcrop northwest of the Camp zone that displayed two sets of mineralized structures: early thick quartz-chalcopyrite veins with thin sericite selvages that dip 80° toward 135° and thin cross-cutting quartz-chalcopyrite veins with wide sericite



selvages that trend 60-80° toward 040° (Britten and Marr, 1995). The outcrop also displays a prominent post-alteration shear fabric that generally strikes northwest and dips 50-80° northeast (Britten and Marr, 1995). Mapping in the Camp-Pass area in 2018 identified two dominant mineralized vein sets generally trending N45W/48NE and N35E/90.



**Figure 7-29:** Drillholes for the Camp zone are shown on the east side of the Figure. The West Zone (discussed below) is shown to the west (DDH 56 and DDH 57).

### 7.4.6 West Zone

The West zone, located 1,000m northwest of the Camp zone, is approximately 400m long and estimated to be at least 160m wide. It forms part of a northwest trending structure and has been tested by only two widely spaced diamond drillholes. The zone is underlain by moderate to weak phyllic altered biotite granodiorite, quartz feldspar porphyry, mafic dikes and xenoliths of volcanic rocks exhibiting hornfels textures.

Potassic alteration is of limited extent and occurs as K-spar halos on veins and fractures. Texturally destructive phyllic alteration (sericite-chlorite-quartz) is the dominant alteration exhibiting sericite-chlorite alteration of plagioclase and mafic minerals, halos on quartz-K-spar-chalcopyrite veins and pyrite veins. Propylitic alteration is restricted to epidote veins exhibiting cross-cutting relationship with early-stage K-spar alteration halos.

The mineralization occurs as discrete intervals ranging over core interval from 3.29 to 29.80m. Copper (chalcopyrite and bornite) occur as blebs, in rare quartz-chalcopyrite-bornite and quartz chalcopyrite-pyrite veins. Molybdenite is restricted in extent and occurs coating fractures within moderate to weak potassic and phyllic-altered biotite granodiorite. Pyrite occurs in both drillholes but is most abundant in DDH-57, being present over the entire length of the drillhole in quartz-chalcopyrite-bornite-and pyrite veins and as dissemination and along fractures.

The copper mineralization is accompanied by low concentrations of molybdenum-gold-silver. The mineralization in DDH-56 is primarily copper with elevated molybdenum concentrations whereas DDH-57 is primarily copper-gold-silver with low concentrations of molybdenum.

Weighted average grades for mineralized intervals in this zone range from 0.19 – 0.56% Cu and mineralized intervals range from 9.7 – 29.8m in core length. See Section 10 for tabulated weighted average mineralized intervals. Drillhole locations for the West zone are shown above in Figure 7-29. Metal concentration ranges within the mineralized intervals are copper 100 to 19,200 ppm; Molybdenum from 0.5 to 480 ppm, gold from <0.005 to 0.40 g/t and silver <0.15 to 5.50g/t.

## **8 Deposit Types**

Porphyry Cu deposits are typically high tonnage (greater than 100 million tonnes) and low to medium grade (0.3–2.0% Cu). They are the world's most important source of copper, accounting for more than 60% of the annual world copper production and about 65% of known copper resources. Porphyry copper deposits are an important source of other metals, most notably molybdenum, gold, and silver.

Porphyry copper deposits in British Columbia have recently been sub-divided into Plutonic, Volcanic calc-alkalic, Volcanic alkalic and Classic based primarily on tectonic setting, host rocks alkalinity index, metal assemblage and age.

In northern British Columbia porphyry copper deposits occur in the Quesnel and Stikine terrains. The porphyry copper mineralization at Eaglehead Project is interpreted to represent Plutonic style porphyry mineralization based on the many similarities to other Plutonic porphyry copper deposits in British Columbia.

In Northwest British Columbia, Plutonic porphyry copper deposits are associated with calc-alkalic, batholith-scale intrusions (ranging in size from 150 to 1,800km<sup>2</sup>) and formed in an Island Arc setting between 215 and 186 Ma. Examples of Plutonic porphyry copper deposits are Highland Valley, Ike, and Gibraltar.

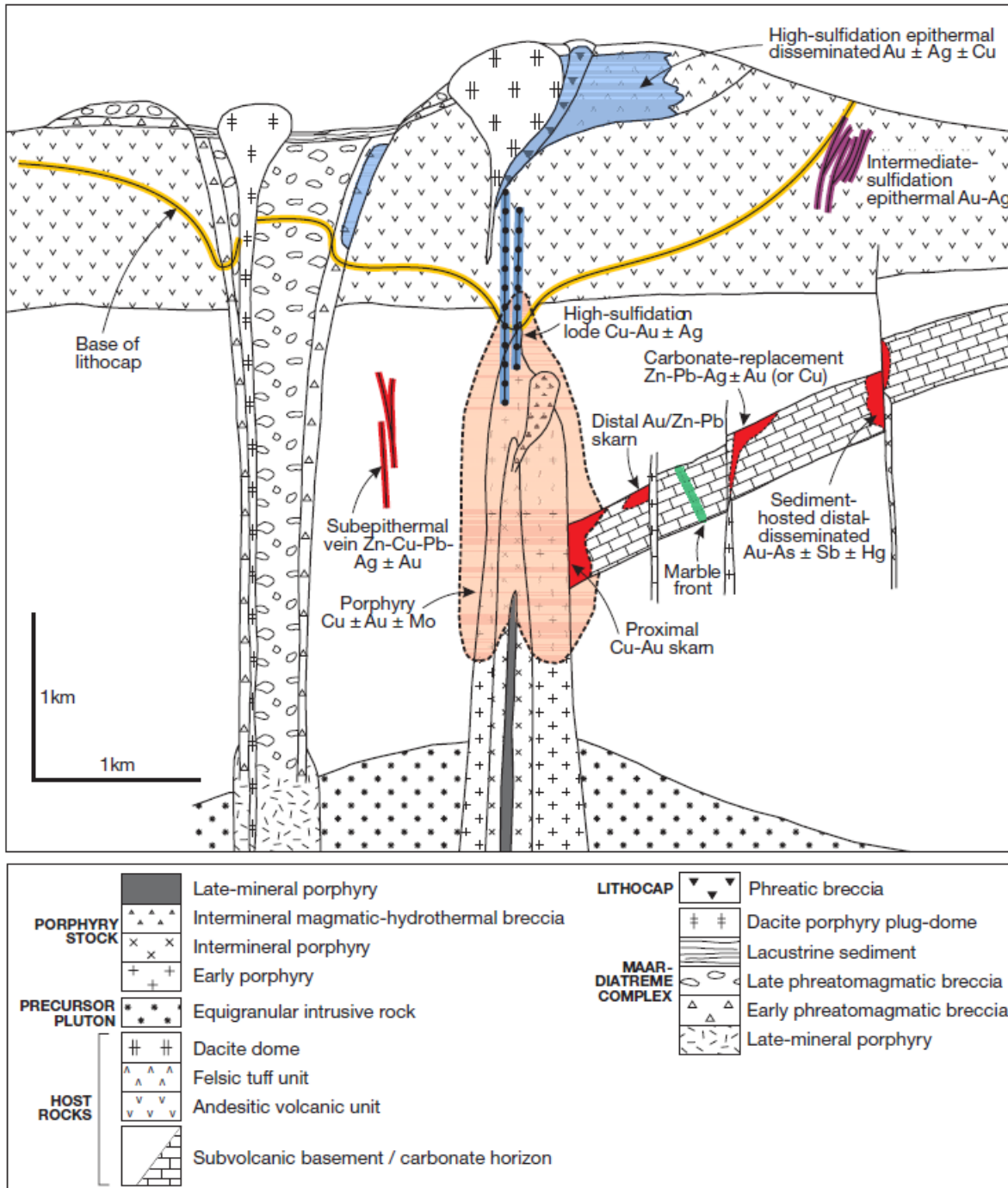
Plutonic Calc-Alkalic porphyry Cu-Mo-Au deposits consist of mineralization that is relatively evenly distributed throughout large volumes of rock hosted in intrusive phases of the host batholith. These deposits are typically formed within a few kilometres of the surface from hydrothermal fluids in the range of < 150 - 300°C. Mineralization is spatially, temporally, and genetically associated with hydrothermal alteration of the host rock intrusions and wall rocks. Intrusions range from coarse-grained phaneritic to porphyritic stocks, batholiths, and dike swarms. Host rock compositions range from quartz diorite to granodiorite and quartz monzonite and can include multiple emplacements of successive intrusive phases and a wide variety of late-stage dikes and magmatic breccias. Comagmatic volcanic rocks may or may not be present in the vicinity of these deposits. A generalized model for a classic Calc-Alkalic porphyry copper deposit is shown in Figure 8-1.

Alteration can consist of a central and early formed potassic zone, that commonly coincides with copper mineralization, that grades outward into an extensive, marginal propylitic alteration halo. These older alteration assemblages can be overprinted by sericite-chlorite-clay and phyllic (sericite-chlorite-silica +/- pyrite) alteration (Figure 8-2). Mineralization consists of stockworks of multi-phase quartz sulphide veinlets, quartz veins, closely spaced fractures and breccias containing pyrite and chalcopyrite with lesser molybdenite and bornite; disseminated sulphide minerals are present, but generally in subordinate amounts.

Porphyry copper deposits commonly are centered on small cylindrical porphyry stocks or swarms of dikes (Panteleyev, 1995; Sillitoe, 2010). However, the geometry and dimensions of porphyry copper deposits vary greatly because of multiple factors including post-ore intrusions, a range of types of host rocks that influence deposit morphology, amounts of hypogene and supergene mineralization each of which has different configurations, and erosion and post-ore deformation including faulting and tilting. Deposit geometries are also determined by lithologic, alteration and structural controls that outline large areas of low-grade, concentrically zoned mineralization.

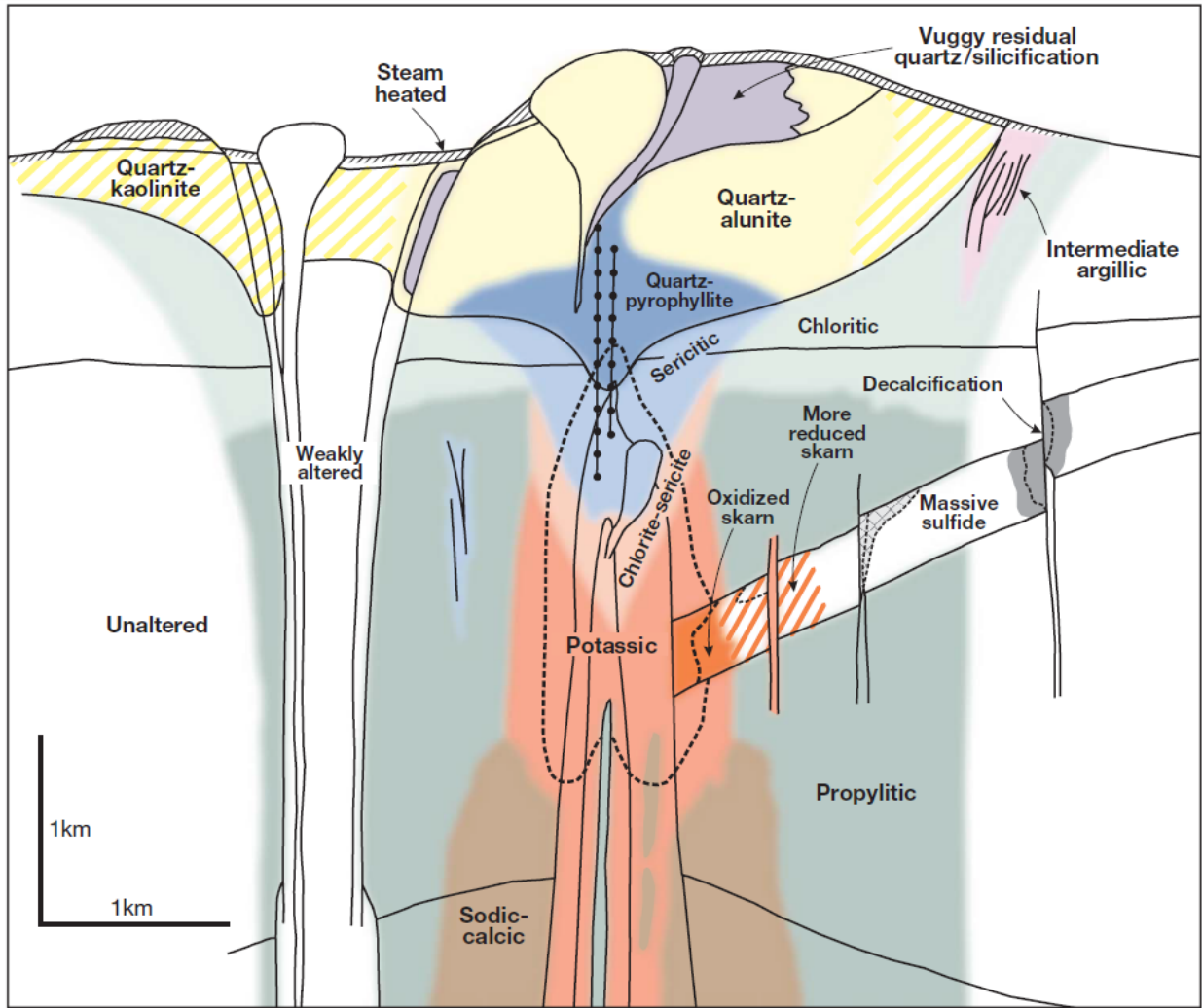
The vertical extent of hypogene mineralization in porphyry copper deposits is generally less than or equal to 1 to 1.5km (Sillitoe, 2010). The predominant hypogene copper sulphide minerals are chalcopyrite, which occurs in nearly all deposits, and bornite, which occurs in about 75% of deposits. Molybdenite, the only molybdenum mineral of significance, occurs in about 70% of deposits. Gold and silver, as by-products, occur in about 30% of deposits.

In porphyry copper deposits, the development of supergene, or secondary copper, mineralization occurs when low-pH groundwater dissolves copper from hypogene copper minerals in an oxidizing environment, and transports and re-precipitates the copper in the form of oxides, carbonates, silicates and or sulphides in a stable, low-temperature, reducing environment. In British Columbia, likely as a result of glaciation, most exposed porphyry deposits lack a supergene zone. Only trace amounts of secondary copper minerals (malachite, chrysocolla, azurite and chalcocite) have been observed at Eaglehead.



(Source: Sillito, 2010)

**Figure 8-1: Generalized Model for a Telescoped Porphyry Copper System**



(Source: Sillito, 2010)

**Figure 8-2: Generalized Alteration-mineralization Zoning for a Telescoped Porphyry Copper System**

## **9 Exploration**

### **9.1 2021 Exploration**

In 2021 Copper Fox completed a 9-week field program consisting primarily of: re-logging, sampling, re-sampling of selected historical diamond drillholes in the Far East and Bornite zones; a deep penetration geophysical survey over portions of the Camp and Pass zones, and a reconnaissance mapping program in the area located north of the Camp and Pass zones to collect data on lithology, alteration and controls on copper mineralization in that portion of the Eaglehead intrusion. Studies completed prior to the field season included a re-interpretation and Magnetic Vector Inversion (MVI) study of the 2014 airborne data, and a re-interpretation of the soil geochemical data (copper-molybdenum in soil) for the area located north of the Pass and Camp zones. The outcrops in the area north of the Pas-Camp zones were initially mapped and sampled between 1971-1975; and in 2018. The 2021 mapping in this area was extended further to the north to include a topographic depression referred to as the Cirque.

On commencing the 2021 exploration program, Copper Fox determined the drill core availability from each of the mineralized zones. It was found that the drill core for all holes completed in the Far East, East, Bornite and West zones were available. Seven of the 16 drillholes in the Camp zone and six of the 24 drillholes in the Pass zone are not available.

#### **9.1.1 Logging of Historical Drill Core - 2021**

The 2021 core re-logging program focussed on the Far East zone. Initially this zone was a distal polymetallic vein system related to the porphyry style mineralization in the East zone. The re-logging of a drillhole from the Bornite zone was also completed in 2021. The information collected from prior drilling programs related to the lithology, sampling, analytical procedures (digestion, detection limits and analytical method) and QA/QC methods (if any) was either partially or not available. In addition, variances in sampling protocols resulted in mineralized intervals of drill core being un-sampled, resulting in analytical gaps within the mineralized envelope.

The 2021 re-logging program focussed on collecting more systematic lithologic, alteration, mineral association, and vein/fracture relationship to build a data base from which to update the geological and alteration modelling for the mineralized zones within the mineralized corridor. The core logging utilized the format established in 2014 with emphasis on alteration, lithology and structural features and estimated percentage of sulphide species (chalcopyrite, pyrite, bornite and molybdenite).

The 2021 analytical program focused on; i) sampling of intervals of the historical drill cores that were not previously sampled and ii) re-sampling of core intervals that were previously sampled but the analytical data for the specific sample interval has been lost and iii) collect trace element geochemical data in addition to copper-molybdenum-gold-silver values. The locations of the drillholes re-logged in 2021 are shown in Figure 9-1. A summary of the drillholes re-logged and sampled in 2021 are shown in Table 9-1.

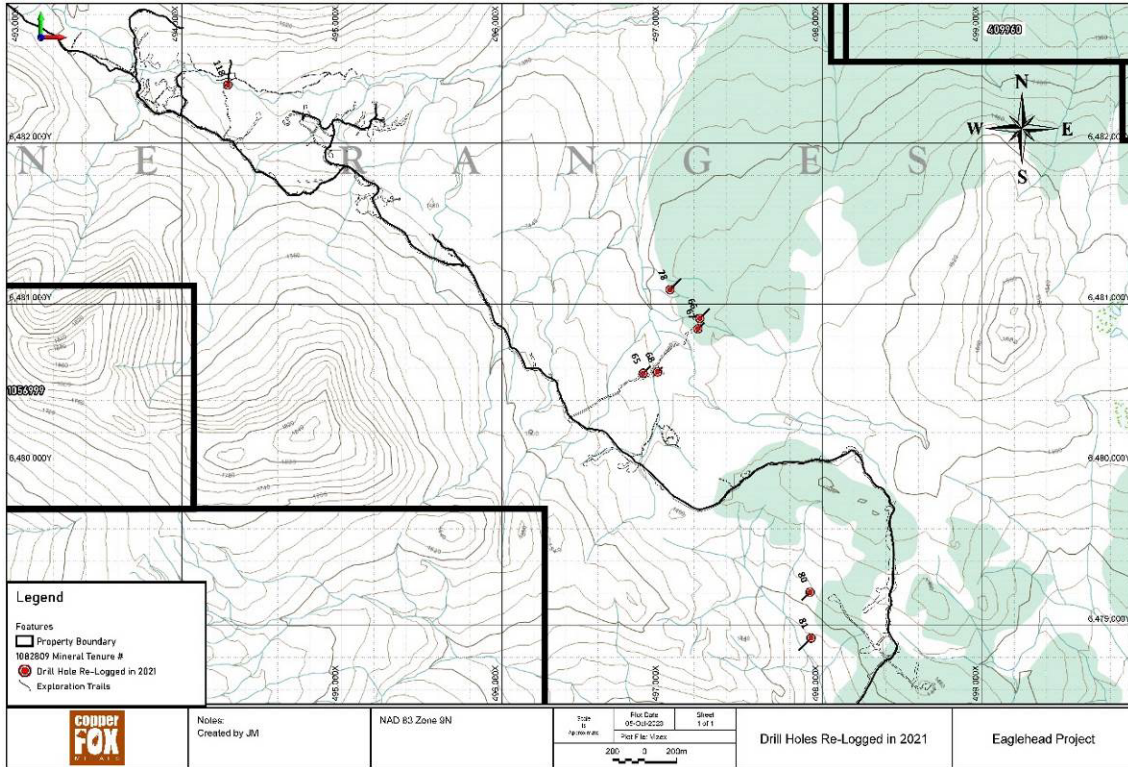


Figure 9-1: Location of drillholes re-logged and sampled in 2021. Eaglehead Project

Table 9-1: Summary of Drillholes Re-logged and Sampled in 2021

Hole No.	Zone	Easting	Northing	Elevation	EOH (m)	Azimuth	Dip	Hole ID	Core Size	Year Drilled	Year Core Re-logged	Year Core Re-sampled
65	Far East	496882	6480568	1425.44	247.80	0	-75	DDH0065	NQ	2006	2021	2021
66	Far East	497236	6480910	1426.46	254.80	0	-70	DDH0066	NQ	2006	2021	2021
67	Far East	497224	6480846	1426.61	166.40	0	-70	DDH0067	NQ	2006	2021	2021
68	Far East	496971	6480577	1420.54	239.57	0	-80	DDH0068	NQ	2006	2021	2021
78	Far East	497049	6481089	1415.61	233.17	45	-65	DDH0078	NQ	2007	2021	2021
80	Far East	497924	6479206	1432	170.69	225	-65	DDH0080	NQ	2007	2021	2016
81	Far East	497930	6478921	1447	261.21	225	-65	DDH0081	NQ	2007	2021	2016
118	Bornite	494287	6482362	1444.45	255.12	5.3	-53.1	DDH0118	NQ	2011	2021	2016

### 9.1.2 Drillhole Summaries - 2021

A total of 293 core samples (including re-sampled core intervals) were collected from five diamond drillholes in the Far East zone. The analytical results for the 2021 sampling program are shown in Table 9-2.



**Table 9-2: 2021 Analytical Core sampling - Far East Zone**

DDH ID	From (m)	To (m)	Interval (m)	Cu (ppm)	Cu (%)	Mo (ppm)	Au (g/t)	Ag (g/t)
65	96.32	99.36	3.04	3550	0.355	11.0	0.038	1.53
	110.36	115.15	4.79	2130	0.213	7.0	0.020	0.76
	135.87	148.74	12.87	910	0.091	7.0	0.017	0.18
	153.92	154.84	0.92	607	0.061	tr	tr	1.30
	162.72	165.20	2.48	796	0.080	tr	0.012	1.46
66	10.05	10.36	0.31	11150	1.115	30.0	0.151	21.20
	29.21	30.00	0.79	1215	0.122	tr	tr	1.57
	42.00	45.99	3.99	530	0.053	tr	tr	0.35
	61.78	62.42	0.64	14300	1.430	tr	0.394	6.93
	70.26	71.32	1.06	20800	2.080	133.0	0.142	28.20
	83.15	114.60	31.45	2670	0.267	36.0	0.063	4.54
	131.98	144.54	12.56	4730	0.473	127.0	0.119	7.53
	157.58	160.32	2.74	18910	1.891	53.0	0.252	13.05
	191.65	192.00	0.35	870	0.087	6.0	0.042	0.47
	213.20	219.15	5.95	1150	0.115	tr	tr	0.16
67	18.60	19.50	0.90	2320	0.232	37.0	0.161	1.07
	31.09	44.80	13.71	560	0.056	33.0	0.012	0.16
	53.95	72.24	18.29	1110	0.111	52.0	0.018	0.32
	104.88	105.00	0.12	4370	0.437	41.0	0.070	1.13
	126.80	133.20	6.40	910	0.091	31.0	0.012	0.29
68	47.00	50.59	3.59	1020	0.102	18.0	tr	1.01
	103.30	103.60	0.30	1790	0.179	tr	tr	1.56
	123.75	125.12	1.37	1780	0.178	21.0	tr	1.19
	157.30	160.30	3.00	650	0.065	20.0	tr	0.56
	198.90	199.80	0.90	1925	0.193	tr	tr	1.35
	208.94	209.70	0.76	1085	0.109	tr	tr	1.40
	215.20	224.30	9.10	1540	0.154	tr	0.120	1.58
	233.50	239.57	6.07	1770	0.177	tr	0.011	2.20
78	116.89	124.05	7.16	2764	0.276	30.0	0.732	6.85
	140.51	151.49	10.98	1355	0.136	14.0	0.343	4.13

**Notes:** a) metal concentrations of less than 0.01g/t Au and 5.0 ppm Mo listed as tr., b) cutoff for mineralized intervals 0.05% Cu., c) grade capping was not employed. d) weighted average interval includes up to 10m core length of material below the Cu cutoff.

The mineralized intervals are hosted in granodiorite, hornblende quartz diorite and mafic volcanics of the Kutcho Formation. The analytical program increased lengths of the mineralized intervals in several drillholes and identified additional intervals of Cu mineralization. The 2021 analytical results yielded similar copper-molybdenum concentrations, lower silver and modestly higher gold concentrations than previously reported from the Far East zone.

### **9.1.3 Lithology Re-logging - 2021**

The data from the 2021 re-logging of historical drillhole in the Far East zone indicated similar lithology, alteration and mineralogical associations as seen in the Bornite and East zones. The re-logging identified biotite granodiorite, hornblende quartz diorite and quartz porphyry. These rock units have been intruded by thin to thick quartz feldspar porphyry, and mafic dikes. A description of the lithologic units encountered in the drillholes re-logged in 2021 from the Far East zone is described in Section 7 of this report.

### **9.1.4 Mineralization Re-logging - 2021**

The drillholes re-logged in 2021 contained intervals of varying lengths and concentrations of chalcopyrite and lesser amounts of bornite and molybdenite. Pyrite is ubiquitous and on occasion accompanies the copper sulphide mineralization.

Chalcopyrite, the main copper mineral occurs mainly as fracture filling, quartz veinlets and quartz vein center filling with lesser amounts as disseminations, blebs, stringers in biotite veins and associated with mafic minerals. The higher concentrations of chalcopyrite-bornite-molybdenite occur in areas of increased fracture density. Chalcopyrite and pyrite in varying concentrations extend over variable intervals in most drillholes. The concentration of pyrite in the drill core re-logged in 2021 is estimated to be less than 1%. Bornite and molybdenite are restricted in extent and where present usually occurs with chalcopyrite in quartz veinlets, on fractures, in breccia zones and rarely as blebs. Several intervals of molybdenum (based on analytical results >30 ppm) were outlined by the 2021 sampling program.

### **9.1.5 Alteration Re-logging - 2021**

The dominant alteration observed during the re-logging program was overlapping phyllic with lesser concentrations of potassic alteration. Narrow intervals of propylitic alteration (typically pervasive with minor epidote veining) occur within the potassic/phyllic zones. Narrow intervals of late-stage intense potassic alteration (normally associated with late structures and veinlets) were also observed in the drill cores. All mafic dikes exhibit propylitic alteration.

### **9.1.6 Surface Mapping- 2021**

The reconnaissance style mapping focussed in the area north of the Pass-Camp-West zones and in the Cirque to determine the extent of the copper mineralization and alteration in these areas.

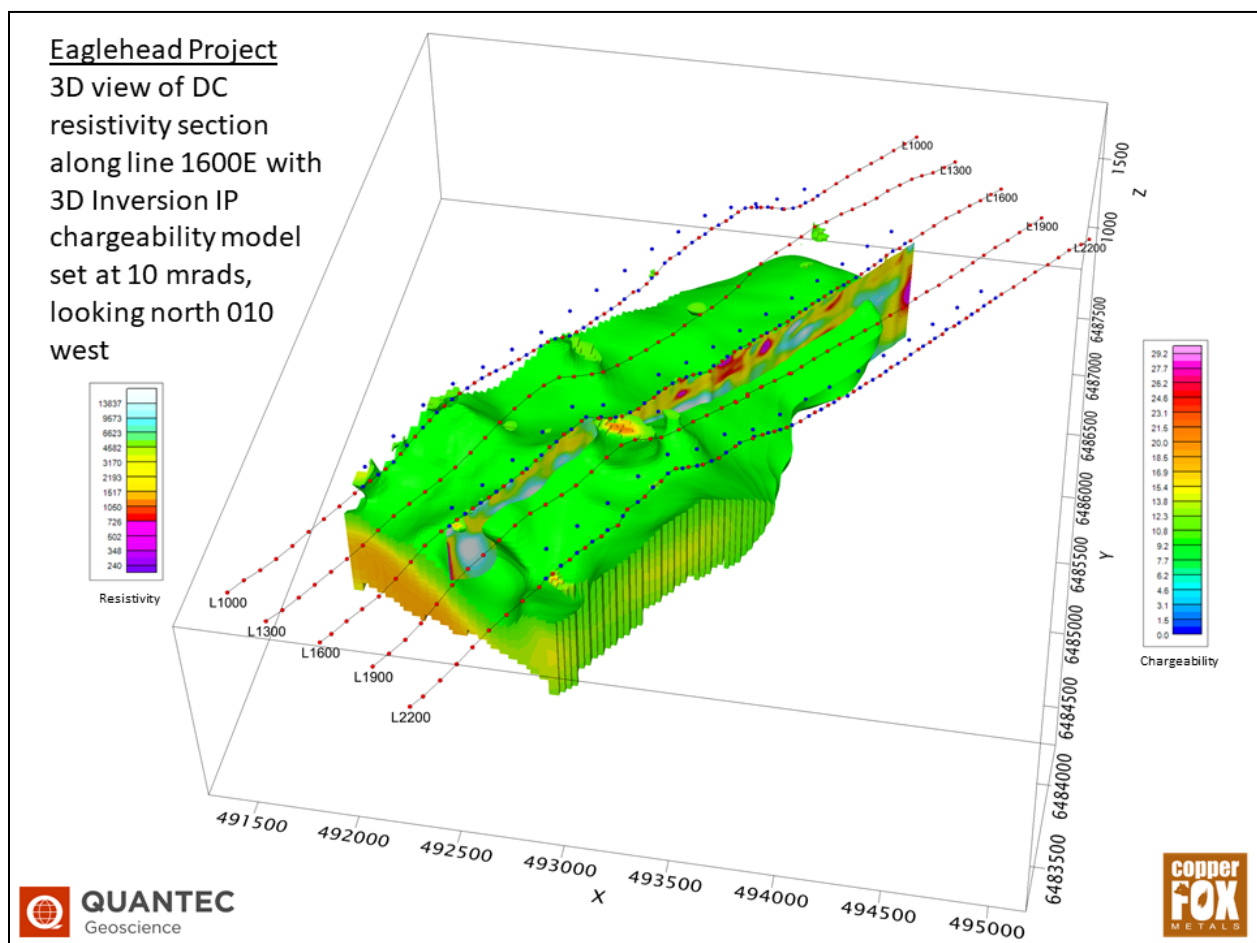
The predominant lithology in the area mapped in 2021 was the Eaglehead quartz porphyry “PGD” of Caulfield (1982) or “igd” of District Copper nomenclature. Listwanite was found at the extreme southwestern and northeastern portion of the Cirque. Very thin, volumetrically negligible aplite, pegmatite and mafic dykes were observed cutting the Eaglehead quartz porphyry.

The program located several new occurrences of copper in fractures and quartz-chalcopyrite veinlets hosted in phyllic and potassic altered biotite granodiorite. Chrysocolla, malachite, chalcocite and less commonly pitch limonite and neotocite were also observed. Malachite was also observed on biotite granodiorite fragments contained within vertically dipping, magmatic breccia pipes that range in size from 5 to 30m in outcrop exposed in the Cirque walls. The copper-bearing fractures and quartz-chalcopyrite veinlets show a wide range of orientations, similar to that found by previously mapping programs in other parts of the property.

### 9.1.7 2021 Geophysical Survey:

Quantec Geosciences utilizing their ORION SWATH configuration completed a helicopter supported deep penetrating survey (10.8-line kms) over an area measuring 1.2km wide by 3.6km long. The receiver dipole spacing was 100m for all lines. The off-line receive electrode for orthogonal ( $E_y$ ) dipoles was located 100m to west side of the inline dipole array except in instances of severe topography. The 2D, DC resistivity and chargeability inversion models were generated for each subset of inline data as well as 3D inversion models of the full inline and crossline dataset.

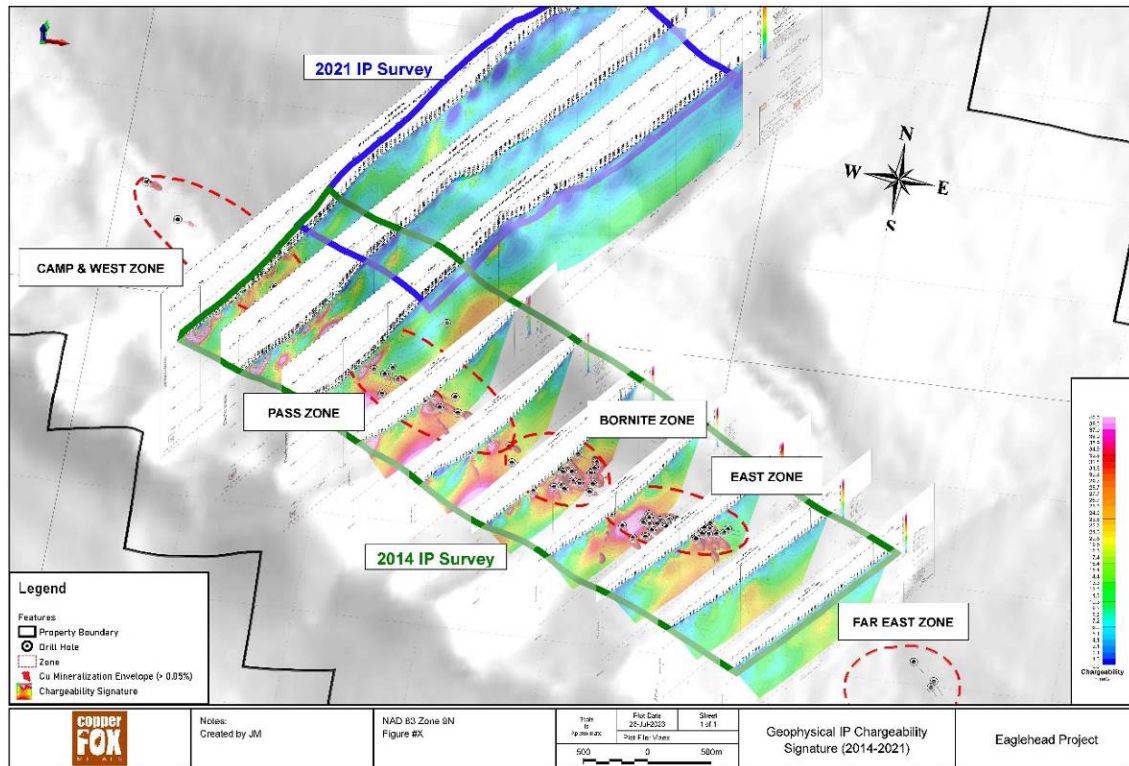
The survey covered a portion of the large copper-molybdenum in soil geochemical anomaly and the area of abundant copper mineralization (in outcrop/subcrop) located north of the Pass and Camp zones and the Cirque area. The survey outlined a large positive chargeability ( $> 10$  mrad) target shown in Figure 9-2.



**Figure 9-2: Chargeability anomaly outlined by 2021 Quantec geophysical survey, Eaglehead project.**

The open-ended 2,500m long by 1,200m wide, northerly dipping positive chargeability ( $>10$ mrad) anomaly is located on the northern flank of the Magnetic Vector Inversion anomaly underlying the Camp zone. DDH-032 located approximately 500m north of the Pass zone is interpreted to have intersected the upper level of the chargeability anomaly and returned sporadic intervals of copper mineralization with individual samples returning up to 0.48% copper.

Quantec also merged the 2014 geophysical survey data with the 2021 geophysical data to provide a more comprehensive subsurface picture of the chargeability and resistivity signatures underlying the mineralized corridor and the area north of the Camp-Pass zones. The merging of the two data set indicated that the chargeability signature associated with the porphyry style mineralization in the Camp and Pass zones extends to the north under the copper-molybdenum in soil geochemical anomaly and the area of abundant copper showings, Results of the merging of the 2014 and 2021 data sets are shown in Figure 9-3.



**Figure 9-3: Merged 2014 and 2021 Quantec geophysical survey data, Eaglehead project.**

### 9.1.8 Airborne Magnetic Survey - 2021

In March 2021, Campbell & Walker Geophysics Ltd completed a re-interpretation of the 2014 high sensitivity airborne geophysical survey. The data was upwardly continued to an elevation of 60m above surface prior to commencing the re-interpretation. The work identified several previously unrecognized regional scale subsidiary faults related to the larger, regional scale Thibert and Eaglehead fault systems. One of these interpreted structures crosses the 500m gap between the Bornite and East zone. The re-interpretation also indicates a strong spatial correlation between the Thibert structural zone and five previously identified zones of porphyry style mineralization within the project.

### 9.1.9 Magnetic Vector Inversion Study - 2021

Campbell & Walker Geophysics Ltd completed a Magnetic Vector Inversion (MVI) study on the 2014 airborne magnetometer data. The MVI analysis was completed using Geosoft's VOXI Magnetic Vector Inversion software. Multiple inversions were carried out to find a model that fit the observed data within the allocated noise threshold while not adding unnecessary features to the model. The final model was

generated by applying the VOXI IRI focussing method to recover a sharper model. Horizontal slices ranging from 200 to 600 meters below surface were generated during the modelling.

The study identified five positive magnetic signatures that are interpreted to represent potassic (magnetite) alteration associated with late-stage intrusive plugs located at various depths below the Bornite-East zone, West-Camp zone, between the East zone and the Far East zone and on the west side of the Thibert Fault. Four of the five anomalies exhibit a strong spatial association with the Thibert Fault system. The anomaly located on the west side of the Thibert Fault suggests that the Thibert Fault offset the mineralization in the Bornite and East zones potentially up to 1km to the east. Results of the MVI study at the 600m level are shown in Figure 9-4.

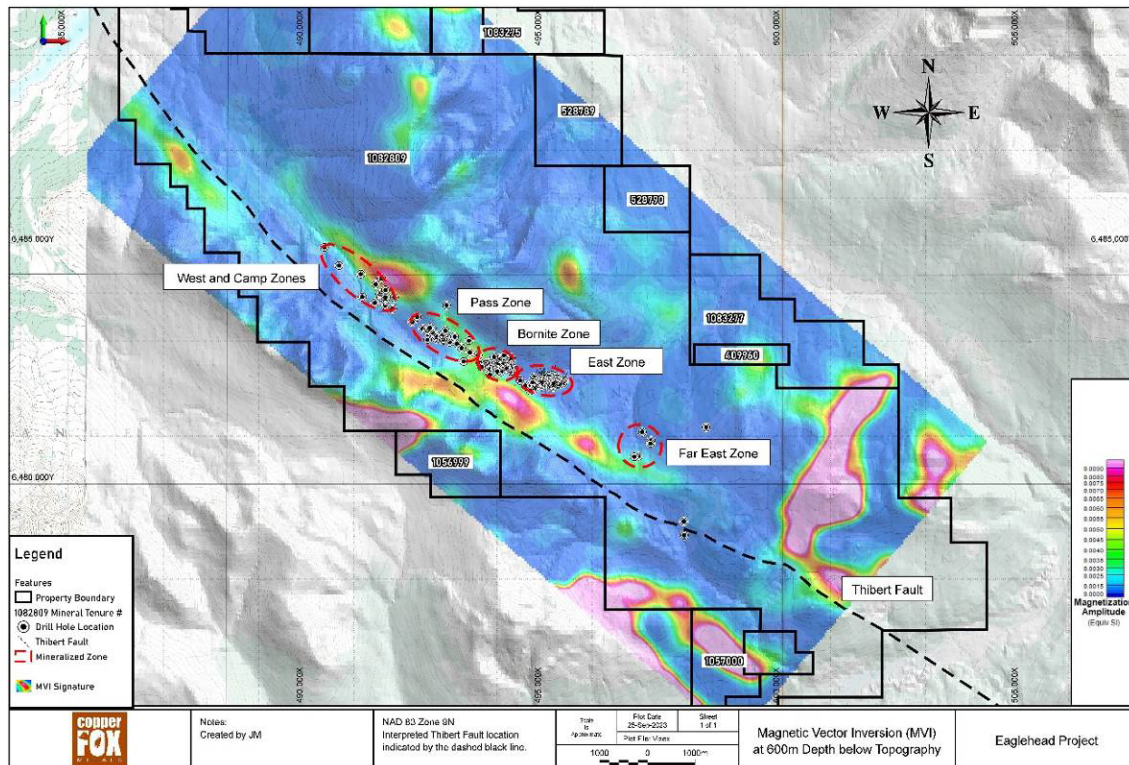


Figure 9-4: Magnetic Vector Inversion anomalies identified in 2021. Eaglehead project

### 9.1.10 Baseline Water Quality Survey - 2021

In 2021, Copper Fox established a series of water monitoring stations (15 stations) covering the stream drainage for collection of water samples to establish a baseline water quality for the project prior to commencing drilling activities. The water samples after collection were prepared for transport and delivered to ALS Laboratories (Terrace British Columbia) within 48 hour of sample collection time. The samples were analyzed for 48 trace elements (metals), mercury, and total dissolved solids (TDS). The sampling was completed in June and September. The results of the survey indicate that all parameters tested were below BC Drinking Water Quality and Aesthetic Guideline limit.

### 9.2 2022 Exploration

The focus of the 2022 program was to complete the re-logging process initiated in 2021 to update the geological and alteration models for the mineralized zones within the mineralized corridor. Work

performed in 2022 included re-logging of 34 drillholes and a review of 54 drillholes in the West, Camp, Pass, Bornite and East zone, a preliminary archeological survey of a portion of the project, and age dating (Pb-U on zircon) of the hornblende quartz diorite and quartz porphyry and petrographic studies. Sampling of mineralized drill core and re-analyses of 270 pulp samples (initial analyses completed using aqua regia digestion) of drill core was also completed. The strong spatial alignment of the open-ended zones of porphyry mineralization and late stage felsic intrusives to the Thibert Fault system suggests that the Thibert Fault system exerted significant control on the emplacement of the late stage felsic intrusives and porphyry mineralization.

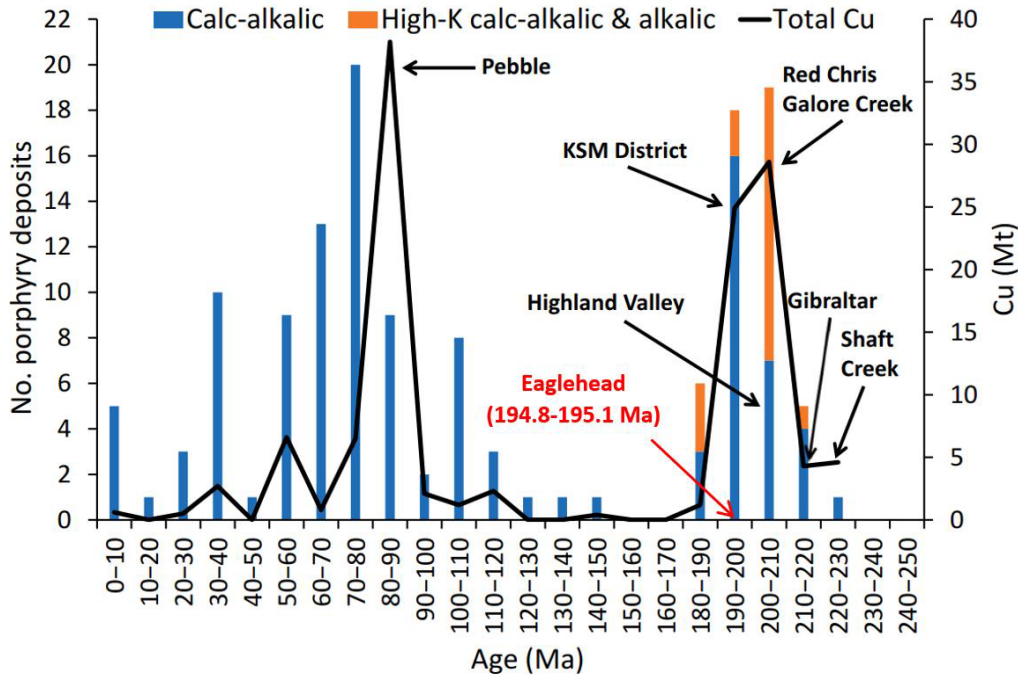
Based on the results of the 2021 and 2022 re-logging, core review and age dating, the generalized sequence of intrusive activity for the property has been revised and is as follows:

- Hornblende Quartz Diorite (phase 1),
- Quartz Porphyry (phase 2),
- Biotite granodiorite (phase 3)
- Quartz Feldspar Porphyry (phase 4), and
- Late mafic dikes (phase 5).

### **9.2.1 Age Dating - 2022**

Age dating (U/Pb zircon, based on 12 determinations) of samples of the hornblende quartz diorite and quartz porphyry from the Eaglehead intrusive was performed by the Pacific Centre for Isotopic and Geochemical Research located in Vancouver, British Columbia. The study yielded a Lower Jurassic age with the average age for the hornblende quartz diorite at 195.1 $\pm$ 0.13Ma and for the biotite granodiorite 194.8  $\pm$  0.1Ma; comparable to other calc-alkalic copper porphyry systems in British Columbia Figure 9-5.

Age dating (Re-Os) of molybdenite mineralization yielded a 194.2  $\pm$  0.9 Ma. date indicating emplacement of the porphyry style copper-molybdenum-gold-silver mineralization occurred 500,000 to 700,000 years after emplacement of the Eaglehead intrusive.



(Source: "Porphyry Deposits of the Northwestern Cordillera of North America: A 25-Year Update", edited by Sharman E.R., et al. (2020). Page 4, *Special Volume 57*. Canadian Institute of Mining, Metallurgy and Petroleum)

**Figure 9-5: Timing of Eaglehead intrusion in relation to emplacement of other porphyry systems in British Columbia**

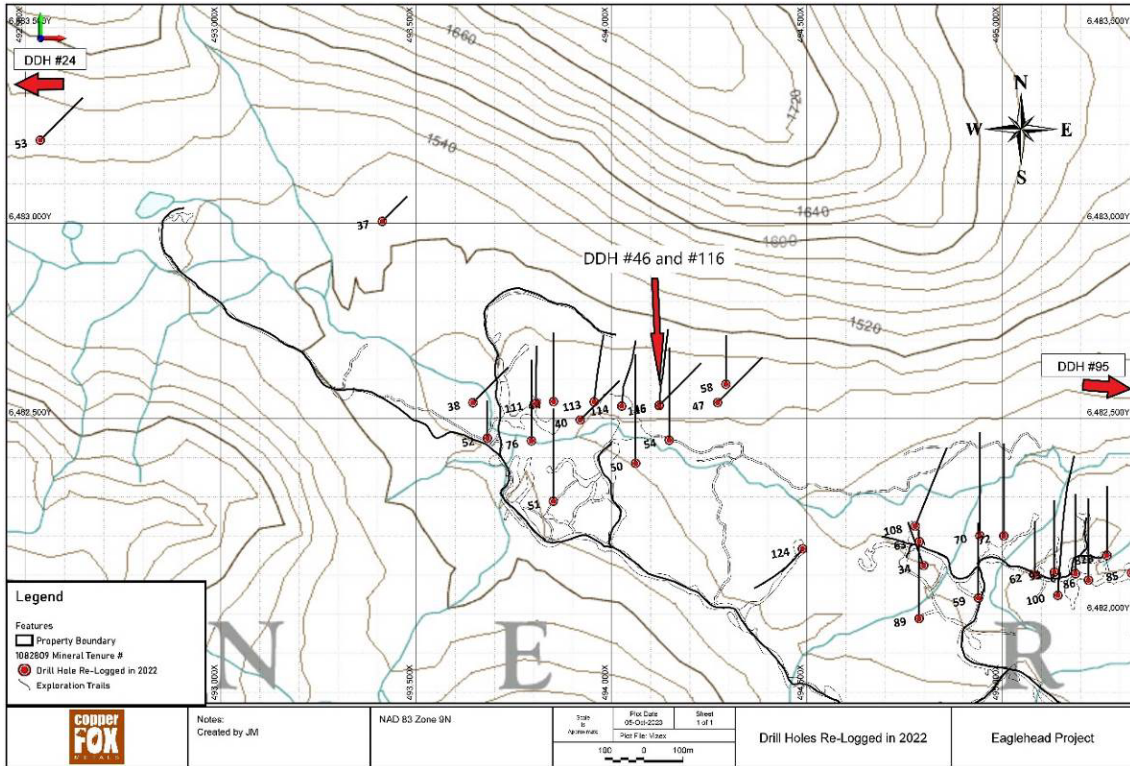
### 9.2.2 Archaeology Survey - 2022

In June 2022, Cordillera Archeology completed a preliminary archeological assessment of the proposed access route and locations for the 2022 drilling program, a post-impact assessment of the existing Eaglehead Camp and an assessment of other parts of the Eaglehead Claim area not related to proposed 2022 program. pursuant to Permit 2022-0323.issued under the *Heritage Conservation Act* of British Columbia.

Results of the survey results indicated no areas of historical, cultural or habitation sites and that the project components are not in conflict with any noted areas of moderate or high archaeological potential. The archeological survey recommended that if, during any ground disturbance, suspected archaeological material is identified, all work should cease until the BC Archaeology Branch and First Nations have been notified and that a qualified archaeologist should assess the area and make recommendations, in writing, prior to the continuation of work.

### 9.2.3 Re-logging and Sampling Program - 2022

The re-logging program included core re-logging and reviewing the lithologies, alteration and mineralization in 34 historical drillholes within the Camp, Pass, Bornite and East zones. The work was completed to either confirm or revise previous descriptions of lithology, alteration, mineral associations and cross-cutting vein and fracture relationships. The locations of the drillholes re-logged in 2022 are shown in Figure 9-6.and listed in Table 9-3.



**Figure 9-6: Location of drillholes re-logged in 2022**

A summary of the drillholes re-logged in 2022 is shown in Table 9-3.



**Table 9-3: Summary of drillholes re-logged in 2022. Eaglehead project.**

Hole No	Zone ID	Easting	Northing	Elevation	EOH (m)	Azimuth	Dip	Year Drilled	Year Core Relogged	Year Core Re-Sampled	Year Pulps Analyzed
24	Camp	491622	6483852	1509.56	224.90	45	-50	1973	2022	2022	
34	East	494795	6482121	1439.00	179.80	340	-50	1976	2016_2022	2016_2022	
37	Pass	493376	6482999	1497.06	165.31	45	-58	1979	2022	2022	
38	Bornite	493644	6482537	1466.96	185.93	45	-50	1979	2018_2022	2018_2022	
40	Bornite	493918	6482497	1454.96	246.75	45	-55	1980	2016_2022	2016_2022	
44	Bornite	493849	6482544	1458.00	246.14	0	-45	1980	2016_2022	2016_2022	
46	Bornite	494095	6482531	1458.21	244.00	45	-55	1980	2018_2022	2018_2022	
47	Bornite	494269	6482541	1460.38	242.90	45	-50	1980	2018_2022	2018_2022	
50	Bornite	494025	6482381	1448.71	451.10	0	-55	1981	2016_2022	2016_2022	
51	Bornite	493814	6482284	1467.28	431.90	0	-60	1981	2014_2022	2016	
52	Bornite	493704	6482400	1469.83	282.20	0	-70	1981	2018_2022	2018_2022	
53	Pass	492539	6483215	1543.10	263.50	45	-55	1981	2014_2022	2015	
54	Bornite	494146	6482446	1449.00	414.50	0	-55	1981	2016_2022	2016	
58	Bornite	494293	6482587	1464.40	295.70	0	-65	1981	2018_2022	2018_2022	
59	East	494936	6482042	1433.00	317.60	0	-50	1981	2016_2022	2016_2022	
62	East	495085	6482100	1438.18	240.20	0	-55	2006	2016_2022	2016	
63	East	494788	6482184	1441.00	245.70	0	-90	2006	2016_2022	2016	
70	East	494941	6482199	1431.00	411.90	0	-50	2007	2016_2022		2016
72	East	495002	6482201	1438.00	412.09	0	-55	2007	2016_2022	2016	2016
76	Bornite	493795	6482440	1459.78	321.87	0	-50	2007	2016_2022	2016	2016
82B	East	495268	6482151	1436.12	419.71	0	-65	2008	2014_2022	2016	2016
85	East	495330	6482105	1435.83	361.79	180	-65	2008	2014_2022	2016	2016
86	East	495221	6482088	1438.45	453.24	0	-65	2008	2016_2022	2016	2016
87	East	495187	6482104	1438.93	431.90	0	-65	2008	2016_2022	2016	2016
89	East	494784	6481990	1440.00	396.54	0	-55	2008	2016_2022	2016	2016
93	East	495134	6482105	1435.89	435.25	0	-65	2008	2014_2022	2016	2016
95	Far East	498391	6481187	1502.00	213.66	0	-65	2008	2022		2016
100	East	495143	6482047	1440.17	548.00	4	-50	2011	2016_2022		2016
108	East	494776	6482225	1438.00	335.90	22	-50	2011	2018_2022		2016
111	Bornite	493807	6482538	1461.80	206.35	359	-47	2011	2018_2022		2016
113	Bornite	493954	6482541	1458.61	252.40	7	-50	2011	2018_2022		2016
114	Bornite	494025	6482529	1457.98	331.00	5	-62	2011	2014_2022		2016
116	Bornite	494122	6482534	1461.88	318.40	5	-54	2011	2018_2022		2016
124	East	494489	6482169	1466.00	615.09	215	-75	2014	2022		

Compilation of lithology, alteration, and mineral associations data prior to commencing the 2022 field season, indicated discrepancies that required verification. To facilitate the verification process, drill core from 54 drillholes in the East, Bornite, Pass, Camp and West zones were reviewed on site to either confirm

or amend previously reported data. The locations of the drillholes reviewed in 2022 are shown in Figure 9-7.

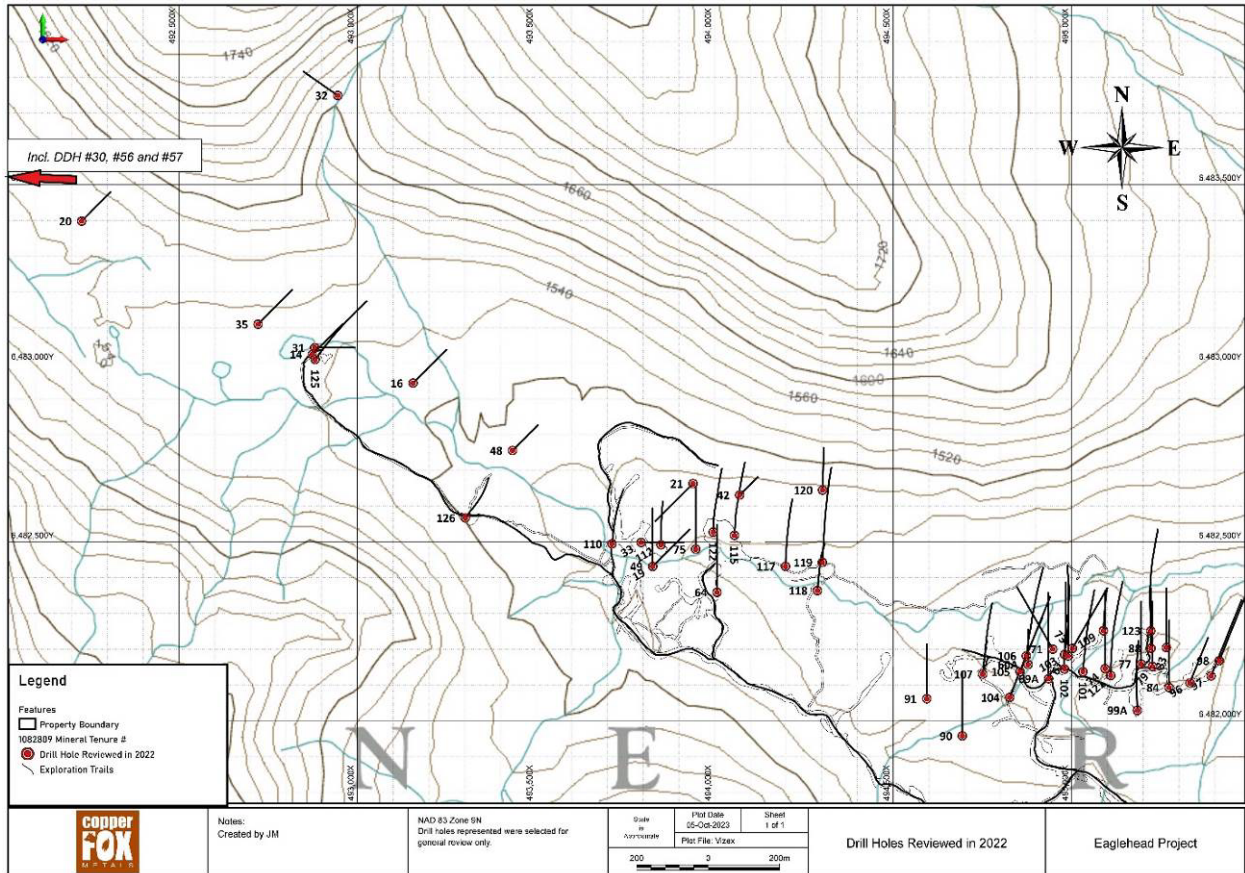


Figure 9-7: Locations of drillholes reviewed in 2022, Eaglehead Project

The re-logging program identified previously unsampled intervals (totalling 175m core length) of copper mineralization (chalcopyrite +/- bornite) in 11 drillholes. The sampling program extended the limits of the mineralized envelope in several drillholes. The weighted average grades (0.05% Cu cutoff) of the intervals are set out in Table 9-4.

**Table 9-4: Analytical results of the 2022 drill core sampling program, Eaglehead project**

Zone	DDH #	From (m)	To (m)	Interval (m)	Cu (%)	Mo (%)	Au (g/t)	Ag (g/t)
Camp	24	17.54	30.29	10.29	0.070	0.006	tr	0.21
	24	160.00	189.57	27.00	0.060	0.004	tr	0.07
Pass	37	139.00	155.24	16.24	0.133	tr	0.02	0.15
Bornite	40	123.60	131.80	8.20	0.090	tr	0.02	0.17
	58	282.00	295.70	13.70	0.100	tr	tr	0.26
East	59	96.85	103.00	6.15	0.051	tr	tr	0.21
	59	109.35	115.55	6.20	0.130	tr	tr	0.43

**Notes:** a) metal concentrations of less than 0.01g/t Au and 5.0 ppm Mo listed as tr, b) cutoff for mineralized intervals 0.05% Cu., c) capping of higher-grade sample results were not employed. d) mineralized intervals in the above table do not represent true thickness.

In addition to the drill core sampling program, pulps samples (270 samples) from five drillholes (DDH-13, 23, 53 and 125) were re-analyzed utilizing a four-acid digestion in 2022.

#### **9.2.4 Mapping Program - 2022**

Reconnaissance mapping in the area covering the MVI anomaly on the south side of the Thibert Fault system southwest of the Bornite zone, located an area of copper mineralization measuring approximately 300m by 200m hosted in phyllic altered hornblende quartz diorite. Malachite with minor azurite occur in extensively leached, quartz veinlets, along shear planes and disseminated throughout the hornblende quartz diorite. Pyrite and limonite, along with several anhydrite veinlets and epidote veinlets were observed within this area.

Samples from two of the eight copper showings located during the 2022 mapping program contained remnant malachite lining quartz veinlets centers were submitted for analyses. A sample located 770 meters ('m') northeast of camp yielded 0.11% Cu, trace Mo, <5 ppb Au, and 0.165 g/t Ag. The second sample 900m west of camp returned 0.66% Cu, trace Mo, trace g/t Au, and 0.434 g/t Ag.

Mapping in the area north of the Bornite-East zones, located a NW trending NE dipping (55°) fault zone. Structural relationships suggest transport of the hangingwall of the fault to the west. The location of this north dipping fault zone provides a better understanding of the location and morphology of the chargeability anomaly identified by the 2021 geophysical survey.

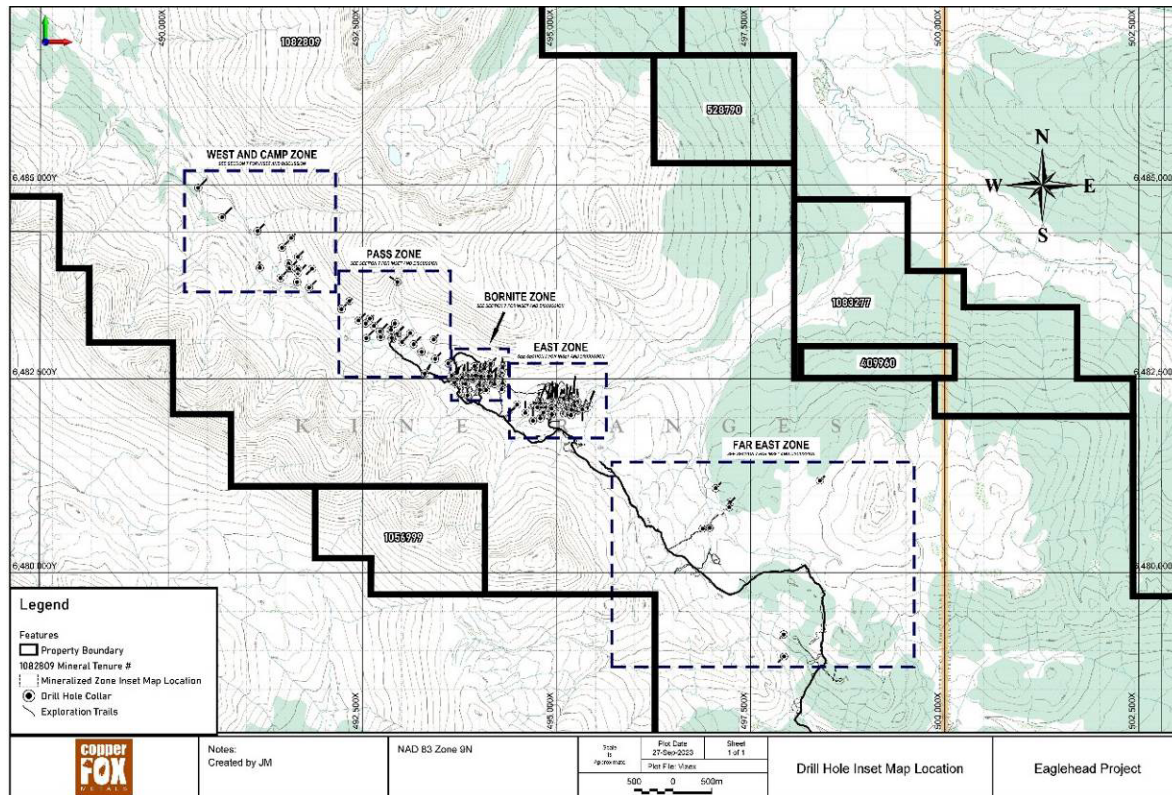
#### **9.2.5 Water Surveys - 2022**

Samples collected in early July, and in mid-September (32 water samples from 16 sites) were analyzed for components outlined in the BC Drinking Water Quality and Aesthetic Guidelines. Negligible changes were observed in the analytical results generated in 2021 and 2022.

## 10 Drilling

### 10.1 Drilling by Previous Operators

A total of 126 exploration diamond drillholes with an aggregate length of 36,605.9m have been completed on the Eaglehead Project. The holes were drilled from 1965 to 2015 by various operators as detailed in Section 6 of this report. The drillholes tested six mineralized zones located within a northwest trending mineral corridor that is approximately 8kms long and up to 3.0 kms wide. Drill core is currently stored near the Eaglehead camp in carefully arranged stacks, or in metal core racks, that are tightly covered with heavy tarpaulins. The distribution of all holes drilled on the Project is shown on Figure 10-1.



**Figure 10-1: Distribution of Diamond Drillholes, Eaglehead Project (insets refer to drillhole location maps in Section 7)**

By the end of the 2022 field season near-complete technical data has been compiled for the majority of the drillholes within the project. Table 10-1 lists all exploration drillholes completed on the Project by zone.

**Table 10-1: Holes and Metres Drilled by Zone, Eaglehead Project**

Zone	# Holes	# Metres
West	2	523.1
Camp	14	2,562.0
Pass	24	4,819.0
Bornite	33	9,382.5
East	45	17,531.9
Far East	8	1,787.4
TOTALS	126	36,605.9

## 10.2 Drilling by District Copper

District Copper completed a total of 67 drillholes aggregating 24,362m on the Eaglehead project. No drilling has been completed on the Eaglehead Project since 2015.

## 10.3 Summary Comments

The drilling covers approximately 30% of the length of the contact between the Eaglehead pluton and Kutcho Assemblage on the Project tenure. Of the six identified zones within this mineralized corridor, the Bornite and East zones have received most of the drilling. Northwest of the Bornite zone, the Pass and Camp zones have been tested by 38 drillholes, and the West zone by just two drillholes. Southeast of the East zone, the Far East zone has been evaluated by eight diamond drillholes.

The Bornite and East zone has been systematically tested by drilling to average depths below surface of approximately 350m to 400m. The Camp and Pass zones were drill tested to an average depth of approximately 100m apart from two drillholes in the Pass zone that were drilled to depths of between 575m and 606m core length. Three of the drillholes completed in the Far East zone are considered outside the currently defined area of interest.

Of the 126 drillholes completed, drill core from 6 of the holes in the Pass zone and eight of the drillholes in the Camp zone have not been recovered.

## 10.4 Mineralized Intervals

By the end of the 2022 field season near-complete technical data has been compiled for the majority of the drillholes within the project.

The weighted average for the mineralized intervals by zone were calculated using the analytical data base for the project up to the end of 2022 using a 0.10% copper cutoff. Where possible, historical assays were used to calculate the weighted average grades provided that no overlap in interval or grade occurred. The mineralized core intervals do not represent true thickness. Numbers are rounded for presentation purposes. Molybdenum values below 0.003%, gold values below 0.03 g/t, and silver values below 0.5 g/t are reported as trace ("tr"). The composited mineralized intervals can include a maximum interval of 5 meters at or below the 0.10% copper cutoff.

### 10.4.1 Far East Zone

The range of metal concentrations for the Far East zone are:

- <0.5 to 40,900 ppm Cu;

- 0.09 to 458 ppm Mo;
- <0.005 to 1.22 g/t Au;
- <0.02 to 79.10 g/t Ag.

Weighted average grades for mineralized intervals in this zone range from 0.11 – 1.89% Cu and mineralized intervals range from 0.31 – 31.45 m in core length. This table provides the mineralized intervals in the Far East zone. Weighted average grade for copper, molybdenum, gold, and silver for mineralized intervals by zone is provided in the following tables.

**Table 10-2: Selected Drillhole Results - Far East Zone**

Zone ID	Hole #	Azimuth	Dip	From, m	To, m	Length, m	Cu (%)	Mo (%)	Au (g/t)	Ag (g/t)		
Far East	65	0	-75	96.32	99.36	3.04	0.36	tr	0.04	1.53		
				111.25	115.15	3.90	0.25	tr	tr	0.92		
				143.41	148.74	5.33	0.17	tr	0.03	0.52		
Far East	66	0	-70	10.05	10.36	0.31	1.12	0.003	0.15	21.20		
				29.21	30.00	0.79	0.12	tr	tr	1.57		
				61.78	71.32	9.54	0.33	tr	0.05	3.67		
					including	62.42	63.06	0.64	1.43	tr	0.39	6.93
					including	70.26	71.32	1.06	2.08	0.013	0.14	28.20
						83.15	114.60	31.45	0.27	0.004	0.06	4.54
					including	84.43	88.15	3.72	1.50	0.014	0.18	29.55
						131.98	144.54	12.56	0.47	0.013	0.12	7.53
					including	135.33	142.95	7.62	0.59	0.021	0.17	10.39
					including	143.56	144.54	0.98	1.30	tr	0.09	13.75
						157.58	160.32	2.74	1.89	0.005	0.25	13.05
					including	159.11	160.64	1.53	0.15	0.005	0.33	2.41
						213.20	219.15	5.95	0.17	tr	tr	tr
Far East	67	0	-70	18.60	19.50	0.90	0.23	0.004	0.16	1.07		
				53.95	72.24	18.29	0.11	0.005	tr	tr		
				104.88	105.00	0.12	0.44	0.004	0.07	1.13		
Far East	68	0	-80	43.89	44.50	0.61	0.35	0.002	tr	5.00		
				49.37	50.59	1.22	0.25	tr	tr	2.32		
				103.30	103.60	0.30	0.18	tr	tr	1.56		
				124.50	125.12	0.62	0.32	0.004	tr	1.92		
				198.90	199.80	0.90	0.19	tr	tr	1.35		
				215.20	239.52	24.32	0.11	tr	tr	1.31		
Far East	78	45	-65	116.89	124.05	7.16	0.28	0.003	0.73	6.85		
				143.26	151.49	8.23	0.16	tr	0.33	4.48		

**Notes:** The weighted average for the mineralized intervals were calculated using a 0.10% copper cutoff. Where possible, historical assays were used to calculate the weighted average grades provided that no overlap in interval or grade occurred. The core intervals in the above table do not represent true thickness. Numbers are rounded for presentation purposes. Molybdenum values below 0.003%, gold values below 0.03 g/t, and silver values below 0.5 g/t are reported as trace ("tr"). For hole 66, the weighted average for 131.67-144.53m includes null values for the included interval 141.27-143.56m.

#### 10.4.2 East Zone

The range of reported Cu grades for the East Zone

- <0.5 to 99,700 ppm Cu.
- <0.05 to 17,700 ppm Mo.
- <0.005 to 42.91 g/t Au; and
- <0.02 to 98.49 g/t Ag.

Weighted average grades for mineralized intervals in this zone range from 0.10 – 3.60% Cu and mineralized intervals range from 3.00 – 372.16 m in core length. This table provides the mineralized intervals in the East zone.

**Table 10-3: Drillhole Results - East Zone**

Zone ID	Hole #	Azimuth	Dip	From, m	To, m	Length, m	Cu (%)	Mo (%)	Au (g/t)	Ag (g/t)
East	34	340	-50	94.00	172.00	78.00	0.12	0.002	tr	0.67
East	55	6	-50	17.40	63.90	46.50	0.38	tr	0.04	0.86
				87.80	95.30	7.50	0.21	tr	0.05	tr
				115.10	136.00	20.90	0.24	tr	0.04	tr
				211.00	356.60	145.60	0.31	0.007	0.96	1.61
				392.00	402.30	10.30	0.20	0.004	tr	0.98
East	59	0	-50	70.00	87.00	17.00	0.40	0.005	tr	1.34
				142.00	232.00	90.00	0.24	0.003	tr	0.57
				290.45	312.32	21.87	0.20	0.010	tr	0.74
East	60A	0	-75	26.20	30.00	3.80	0.64	0.002	0.04	1.27
				74.00	129.00	55.00	0.12	tr	tr	0.54
				181.00	187.00	6.00	0.31	0.006	tr	tr
				205.00	243.00	38.00	0.28	0.006	0.03	1.30
				269.00	277.00	8.00	0.22	0.005	tr	tr
				331.00	385.90	54.90	0.18	0.007	tr	tr
East	61	0	-55	13.20	155.00	141.80	0.23	tr	tr	0.85
			including	33.00	39.00	6.00	2.05	0.014	0.08	11.44
				167.00	183.00	16.00	0.22	0.005	0.09	1.31
				235.00	319.00	84.00	0.14	0.004	tr	tr
				345.00	419.40	74.40	0.18	0.002	0.04	0.82
East	62	0	-55	38.10	121.00	82.90	0.30	0.004	tr	0.74
				143.00	145.00	2.00	0.45	tr	tr	0.62
				183.00	205.00	22.00	0.21	0.002	tr	tr
				221.00	240.20	19.20	0.17	tr	tr	tr
East	63	0	-90	56.00	75.00	19.00	0.24	0.006	tr	tr
				149.00	159.00	10.00	0.40	tr	tr	6.74
				207.00	215.00	8.00	0.25	0.003	tr	1.45
East	69A	0	-57	21.34	174.00	152.66	0.21	0.003	tr	0.58

Zone ID	Hole #	Azimuth	Dip	From, m	To, m	Length, m	Cu (%)	Mo (%)	Au (g/t)	Ag (g/t)
				238.00	244.00	6.00	2.11	0.124	0.18	12.95
				272.00	432.00	160.00	0.27	0.008	0.05	0.88
			including	360.00	370.00	10.00	0.846	0.025	0.308	3.98
East	70	0	-50	63.09	130.76	67.67	0.16	0.003	tr	1.03
				181.41	237.81	56.40	0.24	0.006	0.05	0.68
				298.63	359.46	60.83	0.27	0.005	0.47	1.63
East	71	330	-60	27.44	38.71	11.27	0.14	tr	tr	1.00
				64.01	96.63	32.62	0.22	tr	tr	1.19
				113.08	131.98	18.90	0.12	0.002	tr	1.00
				154.84	164.90	10.06	0.46	0.019	0.05	0.94
				218.39	277.07	58.68	0.14	0.008	0.03	0.62
				360.89	383.14	22.25	0.18	0.004	0.07	0.83
East	72	0	-55	48.77	134.73	85.96	0.16	0.002	tr	0.79
				159.41	345.04	185.63	0.19	0.007	0.09	0.81
East	73	30	-55	33.53	80.62	47.09	0.31	tr	0.07	1.44
				108.21	188.67	80.46	0.16	0.006	0.05	0.68
				254.51	268.23	13.72	0.28	0.003	tr	0.56
East	74	0	-55	67.67	104.25	36.58	0.18	tr	tr	0.50
				117.96	373.84	255.88	0.31	0.012	0.11	1.50
			including	258.78	292.31	33.53	0.657	0.061	0.324	4.48
East	77	0	-65	27.43	40.54	13.11	0.13	tr	tr	0.92
				74.22	182.58	108.36	0.27	0.004	tr	0.78
				200.86	400.51	199.65	0.26	0.015	0.06	1.15
East	79	0	-65	42.68	414.84	372.16	0.28	0.018	0.12	2.08
			including	50.91	66.14	15.23	2.57	0.115	1.91	33.58
East	82B	0	-65	30.48	374.90	344.42	0.32	0.052	0.09	1.47
			including	123.14	135.94	12.80	3.45	0.547	0.64	18.97
				402.34	416.66	14.32	0.25	0.031	0.09	0.77
East	83	0	-65	63.09	81.69	18.60	0.27	0.010	1.23	1.53
				88.70	315.77	227.07	0.25	0.015	0.05	0.87
				350.22	395.33	45.11	0.12	0.004	0.04	tr
East	84	0	-65	71.02	101.35	30.33	0.24	tr	tr	1.31
				130.31	447.14	316.83	0.26	0.020	0.07	1.22
			including	195.84	213.06	17.22	0.60	0.019	0.09	1.96
East	85	180	-65	90.53	117.96	27.43	0.21	0.004	tr	0.61
				157.58	227.69	70.11	0.15	tr	tr	0.68
East	86	0	-65	35.66	57.00	21.34	0.19	tr	tr	0.54
				114.91	169.77	54.86	0.51	0.026	0.14	1.83
			including	145.39	157.58	12.19	1.92	0.110	0.58	6.82
				188.06	209.40	21.34	0.18	tr	tr	tr
				236.83	258.17	21.34	3.60	0.003	0.03	0.88
East	87	0	-65	23.47	47.85	24.38	0.57	tr	0.04	3.04
				81.38	121.01	39.63	0.93	0.031	0.22	4.31
			including	105.77	124.05	18.28	1.91	0.066	0.47	9.09
				154.53	191.11	36.58	0.14	0.003	tr	tr
				209.40	279.50	70.10	0.14	0.004	tr	tr
				297.79	431.90	134.11	0.25	0.045	0.39	1.05
East	88	0	-65	42.67	303.89	261.22	0.27	0.028	0.08	1.27



Zone ID	Hole #	Azimuth	Dip	From, m	To, m	Length, m	Cu (%)	Mo (%)	Au (g/t)	Ag (g/t)
				322.17	380.09	57.92	0.15	0.009	tr	tr
East	89	0	-55	45.26	93.27	48.01	0.22	0.002	tr	0.92
				132.59	148.44	15.85	0.28	0.003	tr	1.53
				190.35	205.59	15.24	0.11	tr	tr	tr
				229.06	384.05	154.99	0.33	0.003	tr	1.57
East	90	0	-60	87.48	92.96	5.48	0.14	0.006	tr	0.51
				158.50	172.52	14.02	0.17	tr	tr	tr
				191.41	230.12	38.71	0.19	0.003	0.04	0.56
				318.82	362.10	43.28	0.21	0.003	tr	0.65
East	91	0	-60	82.14	97.69	15.55	0.23	tr	tr	0.57
				132.28	190.04	57.76	0.12	tr	tr	tr
				210.31	241.10	30.79	0.11	tr	tr	tr
East	92	0	-65	23.16	38.10	14.94	0.15	tr	tr	tr
				62.33	124.05	61.72	0.28	0.004	tr	1.00
				163.68	207.11	43.43	0.26	0.003	tr	0.59
				246.43	319.43	73.00	0.17	0.007	tr	0.57
				356.01	441.96	85.95	0.33	0.019	0.09	1.44
East	93	0	-65	39.62	130.45	90.83	0.21	0.002	tr	1.10
				218.85	432.21	213.36	0.31	0.036	0.13	1.74
East	94	0	-50	54.86	203.30	148.44	0.24	0.006	0.03	1.00
				224.64	410.57	185.93	0.18	0.007	0.05	0.69
East	96	22	-65	15.50	29.60	14.10	0.17	tr	0.05	0.74
				46.50	66.50	20.00	0.26	0.004	tr	tr
				89.00	110.00	21.00	0.20	0.003	0.13	1.63
				132.50	158.00	25.50	0.25	0.007	tr	0.57
				205.00	210.00	5.00	0.25	tr	tr	2.13
				224.00	325.80	101.80	0.23	0.005	0.03	0.99
East	99A	358.2	-63.9	36.00	65.00	29.00	0.19	tr	tr	tr
				108.00	118.00	10.00	0.19	0.002	tr	tr
				167.00	243.00	76.00	0.35	0.004	0.03	1.72
			including	188.00	201.00	13.00	1.53	0.015	0.15	8.54
East	100	3.5	-49.9	21.00	120.00	99.00	0.17	tr	tr	0.60
				137.00	149.00	12.00	0.80	0.022	0.07	1.41
				167.00	200.00	33.00	0.35	0.025	0.05	0.89
				232.00	461.00	229.00	0.23	0.006	0.03	0.85
			including	281.00	297.00	16.00	0.89	0.032	0.13	3.85
				473.00	543.00	70.00	0.21	0.008	0.04	0.97
			including	507.00	516.00	9.00	0.62	0.020	0.03	1.86
East	101	5.4	-50.5	68.00	139.00	71.00	0.15	0.005	tr	0.62
				149.00	160.00	11.00	0.26	0.006	tr	0.61
				216.00	308.00	92.00	0.20	0.007	0.10	0.65
East	102	359.5	-50.6	24.00	124.00	100.00	0.32	0.004	tr	1.27
			including	47.00	54.00	7.00	1.60	0.048	0.17	11.65
			including	104.00	114.00	10.00	0.60	0.003	0.03	0.74
				204.00	353.00	149.00	0.14	0.004	0.03	0.57
East	103	2.2	-49.9	38.00	66.00	28.00	0.70	tr	tr	2.33
				142.00	190.00	48.00	0.14	0.002	tr	tr
				213.00	273.00	60.00	0.19	0.006	0.11	0.67

Zone ID	Hole #	Azimuth	Dip	From, m	To, m	Length, m	Cu (%)	Mo (%)	Au (g/t)	Ag (g/t)
				323.00	332.00	9.00	0.13	0.003	0.04	0.56
East	104	21.7	-50.9	37.20	147.00	109.80	0.19	tr	tr	0.69
				189.00	200.00	11.00	0.14	0.017	tr	tr
				248.00	251.00	3.00	0.38	0.013	0.05	1.39
				272.00	297.00	25.00	0.22	0.006	0.03	0.64
				338.00	352.00	14.00	0.14	0.004	0.04	0.57
East	105	22	-60	35.00	59.00	24.00	0.56	0.002	tr	1.74
			including	39.00	54.00	15.00	0.80	0.003	0.04	2.40
				70.00	81.00	11.00	0.16	0.004	tr	tr
				89.00	111.00	22.00	0.14	0.002	tr	0.55
				144.00	151.00	7.00	0.10	tr	tr	tr
				181.00	196.00	15.00	0.16	tr	tr	tr
				214.00	241.00	27.00	0.14	0.002	tr	0.56
				284.00	406.00	122.00	0.22	0.003	tr	0.51
East	106	8.1	-48.9	53.00	112.00	59.00	0.17	tr	tr	0.67
				139.00	171.00	32.00	0.22	0.006	tr	0.59
				189.00	244.00	55.00	0.26	0.016	0.07	1.44
				279.00	301.00	22.00	0.30	0.014	0.18	1.14
East	107	6.2	-48.9	41.50	83.00	41.50	0.17	tr	tr	tr
				108.00	112.00	4.00	0.19	tr	tr	0.94
				131.00	248.00	117.00	0.21	0.005	0.04	0.88
			including	197.00	209.00	12.00	0.46	0.015	0.14	2.17
				260.00	296.00	36.00	0.29	0.004	0.07	0.93
East	108	22	-50	85.00	101.00	16.00	0.37	tr	0.54	2.24
			including	85.00	86.30	1.30	2.69	0.006	6.21	20.40
				119.00	122.00	3.00	0.96	0.003	0.03	2.89
				156.00	168.00	12.00	0.13	0.002	0.03	0.75
				179.00	186.00	7.00	0.14	0.004	0.09	0.78
				260.00	266.00	6.00	0.18	0.002	tr	0.51
East	109	3.5	-54.9	95.00	181.00	86.00	0.17	0.003	0.05	0.67
East	121	0	-60	29.87	58.00	28.13	0.60	0.006	0.12	1.99
				96.00	254.00	158.00	0.21	0.003	tr	tr
				306.00	551.08	245.08	0.27	0.025	0.09	1.35
			including	308.00	330.00	22.00	1.02	0.092	0.14	4.94
East	123	0	-65	124.00	228.00	104.00	0.22	0.004	0.10	1.33
			including	124.00	144.00	20.00	0.70	0.006	0.13	3.93
				352.00	358.00	6.00	0.29	0.003	0.24	1.35
				430.00	446.00	16.00	0.27	tr	0.28	2.16
				534.00	548.00	14.00	0.26	0.005	0.10	1.12
East	124	215	-75	122.00	128.00	6.00	0.18	0.002	tr	tr
				176.00	224.00	48.00	0.12	0.008	tr	tr
				274.00	288.00	14.00	0.13	0.004	tr	tr
				332.00	348.00	16.00	0.12	tr	tr	tr
				418.00	502.00	84.00	0.35	0.002	tr	0.84
			including	424.00	450.00	26.00	0.60	0.003	tr	1.29
			including	472.00	476.00	4.00	1.02	tr	tr	2.86

**Notes:** The weighted average for the mineralized intervals were calculated using a 0.10% copper cutoff. Where possible, historical assays were used to calculate the weighted average grades provided that no overlap in interval or grade occurred. The core intervals in the above table do not represent true thickness. Numbers are rounded for presentation purposes. Molybdenum values below 0.003%, gold values below 0.03 g/t, and silver values below 0.5 g/t are reported as trace (“tr”).

#### 10.4.1 Bornite Zone

The range of reported Cu grades for Bornite zones

- <0.5 to 107,000 ppm Cu.
- <0.05 to 4530 ppm Mo.
- <0.005 to 8.04 g/t Au; and
- <0.02 to 75.00 g/t Ag.

Weighted average grades for mineralized intervals in this zone range from 0.10 – 1.05% Cu and mineralized intervals range from 1.00 – 165.00 m in core length. This table provides the mineralized intervals in the Bornite zone.

**Table 10-4: Drillhole Results - Bornite Zone**

Zone ID	Hole #	Azimuth	Dip	From, m	To, m	Length, m	Cu (%)	Mo (%)	Au (g/t)	Ag (g/t)
Bornite	19	45	-50	24.39	45.72	21.33	0.32	tr	tr	tr
				88.30	124.97	36.67	0.29	0.002	tr	tr
				185.93	216.41	30.48	0.31	0.005	tr	tr
Bornite	21	225	-45	15.24	27.44	12.20	0.16	0.002	tr	tr
				42.70	79.20	36.50	0.32	0.003	tr	tr
				88.40	91.44	3.04	0.14	0.002	tr	tr
				106.68	134.12	27.44	0.20	0.003	tr	tr
				149.36	158.50	9.14	0.12	tr	tr	tr
				168.00	213.40	45.40	0.33	0.005	tr	tr
Bornite	23	225	-45	85.30	92.00	6.70	0.33	tr	tr	0.72
Bornite	25	45	-45	42.70	64.00	21.30	0.63	tr	tr	tr
				76.20	88.40	12.20	0.68	0.008	tr	tr
Bornite	33	90	-50	105.80	111.90	6.10	0.98	0.038	tr	tr
				120.90	131.10	10.20	0.21	0.002	tr	tr
				145.70	183.50	37.80	0.52	0.037	tr	tr
Bornite	38	45	-50	46.94	54.87	7.93	0.77	0.004	0.031	1.12
				87.00	102.10	15.10	0.14	tr	tr	tr
				112.09	128.30	16.21	0.33	tr	tr	tr
				149.40	179.34	29.94	0.23	tr	tr	tr
Bornite	40	45	-50	144.40	164.09	19.69	0.17	tr	tr	0.51
				171.72	246.75	75.03	0.45	0.025	tr	0.64
Bornite	42	45	-70	33.86	101.87	68.01	0.53	0.003	tr	1.08
				149.96	170.38	20.42	0.70	0.009	tr	4.61

Zone ID	Hole #	Azimuth	Dip	From, m	To, m	Length, m	Cu (%)	Mo (%)	Au (g/t)	Ag (g/t)
Bornite	44	0	-45	17.12	58.26	41.14	0.61	0.004	tr	7.02
			including	23.18	47.58	24.40	0.90	0.006	tr	7.90
				78.39	83.57	5.18	1.05	0.026	tr	2.18
				36.91	41.33	4.42	0.26	tr	tr	tr
Bornite	45	45	-55	53.99	58.87	4.88	0.21	0.003	tr	tr
				88.45	102.18	13.73	0.26	0.003	tr	tr
				111.63	116.82	5.19	0.25	tr	tr	tr
				143.35	148.23	4.88	0.28	0.005	tr	tr
Bornite	46	45	-55	35.38	43.01	7.63	0.26	0.004	tr	tr
				106.75	114.68	7.93	0.30	0.014	tr	tr
				120.17	142.44	22.27	0.18	0.003	tr	tr
				157.54	163.79	6.25	0.41	0.002	tr	tr
				213.50	233.33	19.83	0.42	0.010	tr	0.60
Bornite	47	45	-50	64.32	80.90	16.58	0.18	0.007	tr	0.71
				88.80	99.05	10.25	0.24	tr	tr	tr
				125.01	132.00	6.99	0.72	0.013	tr	2.19
				138.69	141.40	2.71	0.41	tr	tr	1.24
				232.00	239.00	7.00	0.17	0.004	tr	0.52
Bornite	49	0	-55	87.00	98.20	11.20	0.17	tr	tr	tr
				107.30	215.20	107.90	0.37	0.003	0.073	1.74
				235.10	262.30	27.20	0.12	tr	1.276	1.53
Bornite	50	0	-55	30.00	45.00	15.00	0.17	tr	tr	tr
				102.00	114.00	12.00	0.70	0.003	tr	0.78
				194.00	212.00	18.00	0.56	0.002	0.092	2.33
				316.31	360.00	43.69	0.27	0.005	0.094	1.16
				368.30	378.66	10.36	0.39	0.005	tr	1.66
				405.00	451.10	46.10	0.18	0.005	0.055	0.97
Bornite	51	0	-60	86.00	95.40	9.40	0.37	tr	0.050	0.71
				152.60	161.50	8.90	0.41	tr	0.066	0.75
				294.90	323.00	28.10	0.21	0.004	0.050	0.59
				329.10	350.30	21.20	0.25	0.003	0.120	0.62
				380.90	392.38	11.48	0.19	0.003	0.055	0.53
				401.52	422.87	21.35	0.29	0.004	0.155	1.96
Bornite	52	0	-70	30.80	43.30	12.50	0.38	0.003	0.050	tr
				144.10	161.20	17.10	0.25	tr	0.050	tr
				219.80	229.20	9.40	0.63	0.003	0.050	0.94
				243.30	273.60	30.30	0.15	tr	0.054	tr
Bornite	54	0	-55	62.62	79.00	16.38	0.23	tr	0.047	0.63

Zone ID	Hole #	Azimuth	Dip	From, m	To, m	Length, m	Cu (%)	Mo (%)	Au (g/t)	Ag (g/t)
				125.00	140.20	15.20	0.27	0.007	0.181	0.75
				253.70	289.00	35.30	0.41	0.026	0.062	0.78
				295.00	338.00	43.00	0.62	0.010	0.201	2.10
				402.22	409.50	7.28	0.14	tr	tr	tr
Bornite	58	0	-65	6.70	12.80	6.10	0.31	0.007	0.300	1.00
				157.70	166.10	8.40	0.23	0.003	0.063	0.97
				192.50	205.80	13.30	0.29	tr	0.042	0.53
Bornite	64	0	-62	32.30	40.00	7.70	0.14	tr	tr	tr
				84.00	118.00	34.00	0.13	0.002	tr	tr
				286.00	322.00	36.00	0.13	0.002	tr	tr
				296.00	332.00	36.00	0.13	0.002	tr	tr
				366.00	378.00	12.00	0.27	0.005	tr	0.75
				392.00	407.30	15.30	0.14	0.004	0.031	tr
Bornite	75	0	-55	87.17	99.21	12.04	0.12	tr	tr	tr
				156.06	246.58	90.52	0.30	0.007	0.105	1.03
Bornite	76	0	-50	46.02	53.64	7.62	0.24	tr	tr	tr
				102.41	117.65	15.24	0.21	tr	0.046	0.61
				123.44	188.67	65.23	0.55	0.007	0.147	5.03
				238.96	244.30	5.34	0.30	0.003	0.070	1.40
Bornite	110	7.3	-64.9	28.00	61.00	33.00	0.21	tr	tr	tr
				117.00	188.00	71.00	0.19	tr	tr	0.55
				194.00	258.00	64.00	0.36	0.005	0.038	0.90
				266.00	361.00	95.00	0.31	0.003	0.079	1.83
Bornite	111	359.4	-46.9	26.00	46.00	20.00	0.24	tr	0.034	2.40
				59.00	101.00	42.00	0.75	0.003	0.195	5.29
			including	73.00	82.00	9.00	2.73	0.011	0.689	19.08
				112.00	137.00	25.00	0.29	0.010	0.108	1.70
				190.00	196.00	6.00	0.37	0.002	0.510	0.62
Bornite	112	2.2	-64.4	70.00	92.00	22.00	0.71	0.011	0.218	5.84
			including	73.00	91.00	18.00	0.80	0.013	0.240	6.81
				111.00	178.00	67.00	0.38	0.007	0.232	3.50
			including	126.00	140.00	14.00	1.03	0.017	0.424	12.49
				197.00	209.00	12.00	0.21	tr	0.065	0.60
				246.00	260.00	14.00	0.11	tr	0.344	1.03
Bornite	113	6.7	-49.5	9.70	23.00	13.30	0.22	tr	0.055	0.96
				34.00	47.00	13.00	0.27	tr	0.033	tr
				54.00	60.00	6.00	0.22	tr	0.046	1.15
				81.00	180.00	99.00	0.28	0.012	0.141	0.78

Zone ID	Hole #	Azimuth	Dip	From, m	To, m	Length, m	Cu (%)	Mo (%)	Au (g/t)	Ag (g/t)
			including	106.00	124.00	18.00	0.61	0.020	0.134	0.89
				196.00	215.00	19.00	0.18	tr	0.061	1.17
Bornite	114	5.2	-61.8	50.00	55.00	5.00	0.52	0.004	0.075	3.86
				130.00	295.00	165.00	0.54	0.029	0.295	2.08
			including	157.00	164.00	7.00	0.83	0.081	0.357	3.20
			including	195.00	247.00	52.00	0.85	0.036	0.381	1.80
Bornite	115	3.5	-63	58.00	75.00	17.00	0.10	tr	tr	tr
				90.00	101.00	11.00	0.16	tr	0.048	tr
				154.00	155.00	1.00	1.62	0.002	0.354	7.92
				172.00	204.00	32.00	0.19	tr	0.050	0.51
				213.00	236.00	23.00	0.15	tr	tr	0.53
				244.00	269.00	25.00	0.21	0.008	tr	tr
				328.00	377.00	49.00	0.17	0.003	0.038	0.86
Bornite	116	3.5	-63	11.00	75.00	64.00	0.28	0.002	0.083	1.08
				135.00	251.00	116.00	0.47	0.020	0.267	1.35
				258.00	261.00	3.00	0.29	0.004	0.423	2.62
				275.00	286.00	11.00	0.17	0.004	tr	tr
				295.00	304.00	9.00	0.14	0.013	0.037	tr
				316.00	318.40	2.40	0.33	0.007	0.279	3.72
Bornite	117	1.9	-58	7.00	26.00	19.00	0.16	tr	0.060	0.70
				120.00	122.00	2.00	0.50	tr	0.141	0.86
				128.00	134.00	6.00	0.20	0.002	tr	tr
				187.00	192.00	5.00	0.45	0.002	0.037	1.24
				200.00	212.00	12.00	0.15	0.005	0.078	1.36
				226.00	231.00	5.00	0.25	tr	0.038	0.68
				279.00	313.00	34.00	0.21	0.003	tr	tr
				322.00	334.67	12.67	0.13	tr	0.042	tr
Bornite	118	5.3	-53.1	30.00	35.00	5.00	0.18	tr	tr	tr
				71.00	81.00	10.00	0.18	tr	tr	0.54
				124.00	142.00	18.00	0.17	tr	0.054	1.23
				208.00	209.00	1.00	1.13	tr	tr	2.35
Bornite	119	3.3	-50.1	110.00	117.00	7.00	0.12	tr	0.052	0.64
				222.00	227.00	5.00	0.79	0.011	tr	1.66
				236.00	241.00	5.00	0.31	0.003	0.049	0.95
				274.00	309.00	35.00	0.21	tr	0.072	0.85
				338.00	352.00	14.00	0.24	0.004	0.187	1.77
Bornite	120	1.4	-49.5	29.00	106.00	77.00	0.37	0.008	0.091	0.86
			including	32.00	40.00	8.00	1.04	0.010	tr	1.92
			including	71.00	95.00	24.00	0.53	0.016	0.252	1.22

Zone ID	Hole #	Azimuth	Dip	From, m	To, m	Length, m	Cu (%)	Mo (%)	Au (g/t)	Ag (g/t)
				126.00	133.00	7.00	0.24	tr	0.167	1.09
				145.00	150.00	5.00	0.53	0.002	tr	0.58
Bornite	122	0	-65	73.00	255.00	182.00	0.26	0.007	0.094	1.19
				317.00	325.00	8.00	0.27	0.003	0.119	1.31

**Notes:** The weighted average for the mineralized intervals were calculated using a 0.10% copper cutoff. Where possible, historical assays were used to calculate the weighted average grades provided that no overlap in interval or grade occurred. The core intervals in the above table do not represent true thickness. Numbers are rounded for presentation purposes. Molybdenum values below 0.002%, gold values below 0.03 g/t, and silver values below 0.5 g/t are reported as trace (“tr”). The composite intervals include maximum 5 meters waste (copper grade less 0.10%).

#### 10.4.2 Pass Zone

The range of reported Cu grades for Pass zones:

- <0.5 to 27,900 ppm Cu.
- 0.53 to 3170 ppm Mo.
- <0.005 to 0.889 g/t Au; and
- <0.02 to 20.90 g/t Ag.

Weighted average grades for mineralized intervals in this zone range from 0.11 – 1.81% Cu and mineralized intervals range from 0.28 – 176.0 m in core length.

**Table 10-5: Drillhole results - Pass Zone**

Zone ID	Hole #	Azimuth	Dip	From, m	To, m	Length, m	Cu (%)	Mo (%)	Au (g/t)	Ag (g/t)
Pass	5	45	-50	33.00	103.60	70.60	0.54	tr	tr	1.00
			including	37.00	49.00	12.00	0.98	0.003	0.03	2.12
				161.00	203.00	42.00	0.25	tr	tr	0.66
			including	163.00	167.00	4.00	1.26	0.010	tr	3.02
Pass	13	45	-45	11.30	46.00	34.70	0.67	0.003	tr	1.02
				64.00	70.00	6.00	0.28	0.004	tr	0.63
				160.72	161.00	0.28	1.13	tr	0.06	4.42
				169.70	170.50	0.80	0.29	tr	tr	0.62
Pass	14	45	-55	90.00	104.00	14.00	0.49	tr	tr	0.61
			including	94.00	98.00	4.00	0.90	0.003	tr	1.06
				128.00	144.00	16.00	0.12	tr	tr	tr
				194.00	206.00	12.00	0.27	tr	tr	0.52
Pass	16	45	-50	40.00	46.00	6.00	0.24	tr	tr	0.67
				60.00	76.00	16.00	0.16	tr	tr	tr
				86.00	92.30	6.30	0.13	tr	tr	tr
				122.00	128.00	6.00	0.37	tr	tr	0.63
				150.00	207.41	57.41	0.37	0.005	0.05	0.63
			including	176.00	192.00	16.00	0.75	0.008	0.07	1.07
Pass	17	45	-50	7.62	26.06	18.44	0.28	tr	0.11	0.80
				102.00	144.00	42.00	0.15	0.002	0.08	tr

Zone ID	Hole #	Azimuth	Dip	From, m	To, m	Length, m	Cu (%)	Mo (%)	Au (g/t)	Ag (g/t)
Pass	20	45	-50	146.30	158.30	12.00	0.69	tr	tr	3.57
			including	149.30	155.30	6.00	1.20	tr	0.03	6.54
Pass	27	225	-45	140.20	158.30	18.10	0.41	tr	tr	0.52
				187.00	190.00	3.00	0.21	tr	tr	tr
Pass	31	90	-55	13.10	26.00	12.90	0.14	tr	tr	tr
				44.00	59.00	15.00	0.27	tr	tr	0.74
				88.00	97.00	9.00	0.43	0.005	tr	2.00
				133.00	182.00	49.00	0.23	tr	tr	0.67
Pass	32	305	-50	126.00	142.50	16.50	0.20	tr	tr	tr
				163.50	178.00	14.50	0.21	tr	tr	tr
Pass	35	45	-50	18.00	82.00	64.00	0.49	0.003	tr	1.24
				108.00	114.00	6.00	0.23	tr	tr	0.69
				196.00	202.00	6.00	0.26	tr	tr	tr
Pass	36	45	-45	36.00	46.00	10.00	0.15	0.005	tr	0.79
				56.00	83.57	27.57	0.13	tr	tr	0.57
				115.72	168.00	52.28	0.29	tr	tr	0.64
Pass	37	45	-58	139.00	155.24	16.24	0.13	tr	tr	tr
Pass	39			90.28	93.64	3.36	0.180	0.002	tr	tr
Pass	43	45	-55	51.24	81.10	29.86	0.58	tr	tr	0.81
			including	54.29	66.04	11.75	1.30	0.004	tr	1.38
Pass	48	45	-50	19.52	21.95	2.43	0.25	0.003	tr	tr
				70.00	72.00	2.00	0.13	tr	tr	tr
				102.00	108.28	6.28	0.26	0.003	tr	tr
				118.68	120.48	1.80	0.70	0.018	0.03	1.14
Pass	53	45	-55	64.00	90.00	26.00	0.60	tr	0.05	4.53
			including	68.00	74.00	6.00	1.81	tr	0.13	14.18
				124.00	126.20	2.20	0.73	tr	0.05	3.30
				142.00	157.10	15.10	0.18	tr	tr	tr
				214.00	229.30	15.30	0.37	tr	0.03	0.70
Pass	125	35	-70	66.00	68.00	2.00	0.49	0.003	tr	2.40
				80.00	140.00	60.00	0.25	0.004	tr	0.64
			including	98.00	108.00	10.00	0.71	0.003	0.03	1.62
				172.00	214.00	42.00	0.35	tr	tr	0.80
				278.00	280.00	2.00	0.25	0.017	tr	0.62
				316.00	382.00	66.00	0.13	tr	tr	tr
				420.00	424.00	4.00	0.19	tr	tr	tr
				442.00	452.00	10.00	0.28	tr	0.09	2.90
				470.00	494.00	24.00	0.22	0.008	0.05	0.67
				516.00	606.00	90.00	0.21	0.012	0.12	0.95
Pass	126	35	-80	104.00	106.00	2.00	0.27	tr	tr	2.01
				132.00	140.00	8.00	0.11	tr	tr	0.71



Zone ID	Hole #	Azimuth	Dip	From, m	To, m	Length, m	Cu (%)	Mo (%)	Au (g/t)	Ag (g/t)
				192.00	196.00	4.00	0.15	0.005	tr	0.85
				220.00	396.00	176.00	0.13	0.009	tr	0.68
				476.00	492.00	16.00	0.22	tr	tr	0.66
				516.00	522.00	6.00	0.19	tr	tr	0.61

**Notes:** The weighted average for the mineralized intervals were calculated using a 0.10% copper cutoff. Where possible, historical assays were used to calculate the weighted average grades provided that no overlap in interval or grade occurred. The core intervals in the above table do not represent true thickness. Numbers are rounded for presentation purposes. Molybdenum values below 0.002%, gold values below 0.03 g/t, and silver values below 0.5 g/t are reported as trace ("tr") and ("nd") indicates no data. The composite intervals include maximum 5 meters waste (copper grade less 0.10%). <sup>1</sup>The weighted average of the original historical assays were calculated for core samples were not available for resampling. Hole 43 was not sampled for gold.

### 10.4.3 Camp Zone

The range of reported Cu grades for West-Camp zones are.

- 16.5 to 14,500 ppm Cu.
- 0.5 to 1080 ppm Mo.
- <0.005 to 0.545 g/t Au; and
- <0.02 to 5.50 g/t Ag.

Weighted average grades for mineralized intervals in this zone range from 0.131-0.688% Cu and mineralized intervals range from 1.5m-133.07m in core length.

**Table 10-6: Drillhole Results - Camp Zone**

Zone ID	Hole #	Azimuth	Dip	From, m	To, m	Length, m	Cu (%)	Mo (%)	Au (g/t)	Ag (g/t)
Camp	11	45	-50	7.00	12.60	5.60	0.13	0.003	0.04	tr
				41.00	43.00	2.00	0.16	0.004	tr	tr
Camp	18	45	-45	64.00	78.00	14.00	0.10	tr	tr	tr
				94.00	106.70	12.70	0.34	tr	tr	0.64
				133.00	135.00	2.00	0.32	0.002	0.109	0.80
				146.30	152.00	5.70	0.16	tr	tr	tr
Camp	22	45	-50	12.50	30.78	18.28	0.19	0.010	0.052	0.86
				41.00	42.70	1.70	0.23	0.008	0.152	1.66
				48.77	52.12	3.35	0.21	0.002	0.421	1.31
				59.13	81.64	22.51	0.19	0.006	0.066	0.78
				103.60	115.80	12.20	0.30	0.015	0.045	0.51
				139.00	141.20	2.20	0.65	0.070	0.063	1.88
Camp	24	45	-50	152.40	157.00	4.60	0.22	0.008	tr	0.78
				42.70	57.90	15.20	0.65	tr	tr	tr
				79.20	85.30	6.10	0.58	tr	tr	tr
				100.60	131.10	30.50	0.47	tr	tr	tr
Camp	26	225	-50	216.40	224.90	8.50	0.48	tr	tr	tr
				10.00	22.86	12.86	0.20	tr	0.055	tr
				31.00	33.00	2.00	0.16	tr	0.035	tr
				41.00	83.90	42.90	0.27	0.007	0.033	tr
				77.00	83.90	6.90	0.69	0.036	0.046	0.65
				104.00	106.00	2.00	0.19	tr	tr	tr

Zone ID	Hole #	Azimuth	Dip	From, m	To, m	Length, m	Cu (%)	Mo (%)	Au (g/t)	Ag (g/t)
				112.00	128.02	16.02	0.21	tr	tr	tr
				134.00	136.00	2.00	0.21	tr	tr	tr
				158.50	161.80	3.30	0.23	0.004	tr	0.68
Camp	28	90	-50	14.33	147.40	133.07	0.33	tr	0.038	1.16
Camp	29	90	-80	74.68	92.66	17.98	0.19	tr	tr	0.71
				113.00	121.80	8.80	0.15	tr	tr	tr
				150.00	185.90	35.90	0.31	0.003	tr	tr
				203.00	262.10	59.10	0.32	tr	0.087	tr
Camp	30	0	-90	11.00	27.00	16.00	0.18	tr	0.209	1.09

**Notes:** The weighted average for the mineralized interval for hole 30 was calculated using a 0.10% copper cutoff. Results for holes 7, 9, 22 and 29 were previously composited; no values for Mo, Au or Ag are known. The core intervals in the above table do not represent true thickness. Numbers are rounded for presentation purposes. Molybdenum values below 0.003%, gold values below 0.03 g/t, and silver values below 0.5 g/t are reported as trace (“tr”).

#### 10.4.4 West Zone

**Table 10-7: Drillhole Results, West Zone, Eaglehead Project**

Zone ID	Hole #	Azimuth	Dip	From, m	To, m	Length, m	Cu (%)	Mo (%)	Au (g/t)	Ag (g/t)
West	56	45	-50	20.60	26.50	5.90	0.25	0.003	0.050	0.62
				38.10	56.40	18.30	0.22	tr	0.066	tr
				81.30	92.40	11.10	0.27	0.014	0.050	tr
				145.00	174.80	29.80	0.24	0.007	0.050	tr
				190.30	200.00	9.70	0.37	0.004	0.050	0.66
West	57	45	-50	103.00	118.20	15.20	0.19	0.003	0.056	tr
				161.30	169.50	8.20	0.56	tr	0.050	2.70
				184.20	191.00	6.80	0.19	tr	0.184	1.92
				197.80	208.50	10.70	0.47	tr	0.139	2.71
				257.00	260.20	3.20	0.34	0.002	0.050	0.50

**Notes:** The weighted average for the mineralized intervals were calculated using a 0.10% copper cutoff. Where possible, historical assays were used to calculate the weighted average grades provided that no overlap in interval or grade occurred. The core intervals in the above table do not represent true thickness. Numbers are rounded for presentation purposes. Molybdenum values below 0.003%, gold values below 0.03 g/t, and silver values below 0.5 g/t are reported as trace (“tr”).

## 11 Sample Preparation, Analyses and Security

Diamond drilling has occurred on the Eaglehead Project periodically since to 1965. Sample preparation and analytical methods have varied with the drill programs. For the most part BQ, NQ and HQ-diameter core has been split or sawn and sampled on 1m to 3m intervals. In some cases, individual pieces of whole core were collected between driller blocks, forming a “representative” sample for a broader interval, and submitted for analysis. Drill programs are summarized by year in Table 11-1.

**Table 11-1: Drill Programs by Year, Eaglehead Project**

Year Drilled	# DHs	Total Length (m)	Length Assayed (m)	Length Re-assayed (m)	% Assayed	% Re-assayed
1965	4	450	121	121	27%	100%
1972	6	1,184	175	175	15%	100%
1973	21	3,873	3,236	2,827	84%	87%
1976	3	553	352	292	64%	83%
1979	5	877	541	408	62%	76%
1980	9	1,639	1,193	517	73%	43%
1981	11	3,668	2,866	1,864	78%	65%
2006	10	3,050	2,578	2,564	85%	99%
2007	12	4,101	3,589	3,277	88%	91%
2008	14	5,495	5,074	5,058	92%	100%
2011	25	8,302	7,817	7,802	94%	100%
2014	4	2,229	2,133	2,133	96%	100%
2015	2	1,184	1,151	1,143	97%	99%
<b>Total</b>	<b>126</b>	<b>36,606</b>	<b>30,827</b>	<b>28,181</b>	<b>84%</b>	<b>91%</b>

The drill programs can be divided into four campaigns based on laboratory procedures applied at the time of sampling.

### 11.1 1965 to 1981 Programs

Historical sample preparation, sampling procedures, and lab and analytical methods employed by Kenngo, Nuspar, Imperial, Esso, and Homestake for geochemical sampling and diamond drill core sampling are not known. Sample preparation, sampling procedures, and lab and analytical methods utilized by Poloni, similarly, are not known. While details are not provided in assessment reports, the writer believes that historic sample preparation and security were conducted in an appropriate manner, following best industry management practices at the time the work was completed, and was conducted by, or under the direction of, experienced field exploration personnel.

### 11.2 2006 to 2008 Programs

From 2006 – 2008 drill core sampling was conducted by District Copper personnel, but there is no record of written protocols followed. District Copper reported that sample intervals were determined and marked by the core logging geologist and were split in half longitudinally using a mechanical splitter or a hydraulic splitter. Half of the core was placed in a plastic sample bag with a uniquely numbered tag. The remaining half was returned to the core box for later reference. The sample tag book comprised three distinct tags for each unique number. The second tag was placed in the core box and the third tag remained in the sample tag book for future reference. Samples were shipped to Acme Analytical Laboratories Ltd. (ACME) in Vancouver who analyzed them for copper, molybdenum, and silver by aqua regia (HCL-HNO3-H2O) digestion methods, and gold by fire assay with ICP-ES finish methods. There is no

reference to the use of reference standards, duplicates, or blanks. There is no reference to the use of a check-assay procedure.

While limited information is available, the writer believes that 2006 - 2008 drill core sample preparation, security and analysis were conducted in an appropriate manner, following best industry management practices at the time the work was completed, and was conducted by, or under the direction of, experienced field exploration personnel.

### **11.3 2011 Program**

McDonough and Rennie (2012) of Roscoe Postle Associates Ltd. prepared a technical report on the Eaglehead project and reviewed the 2011 drill campaign assay data and QAQC in detail. The following QAQC graphs under 11.3.1 to 11.3.3 are the result of a new 2023 data compilation and review that aimed to verify and complement McDonough and Rennie's findings.

In 2011, drill core sampling was conducted by District Copper personnel. The Company reported that sample intervals were determined and marked by the core logging geologist and were split in half longitudinally using a core saw. Half of the core was placed in a plastic sample bag with a uniquely numbered tag. The remaining half was returned to the core box for later reference. The sample tag book comprised three distinct tags for each unique number. The second tag was placed in the core box and the third tag remained in the sample tag book for future reference.

Independent quality control/quality assurance ("QAQC") procedures were implemented during the 2011 diamond drilling program. The 2011 procedures, once employed, consisted of the insertion of one certified reference material (CRM) every 20 to 25 samples, the insertion of one blank standard every 20 to 25 samples, and the re-sampling of drill core (field duplicate) every 20 to 25 samples. The field duplicate consisted of a second split of the remaining reference core to produce a quarter-core sample (McDonough and Rennie, 2012).

Core samples were collected and placed into large woven nylon "rice" bags to be flown, via helicopter, to Dease Lake where they were shipped, via independent commercial transport, to ACME. ACME (now Bureau Veritas) operates an independent ISO/IEC 17025:2005 accredited facility in Vancouver, British Columbia, and opened a sample preparation facility in Smithers, British Columbia, in 2011. Later in 2011, some of the District Copper samples were routed to the new facility for preparation before being shipped to Vancouver for final analysis (McDonough and Rennie, 2012).

Samples, upon arrival at the preparation facility, were logged in, dried and crushed to 80% passing 10 mesh (1.70 mm) from which a 250 g sub-sample was taken and pulverized to 85% passing 200 mesh (75  $\mu$ m). Multi-element geochemical analysis using aqua regia digestion was performed and the results for 36 elements reported. The procedure called for a 0.5 g aliquot of the pulverized material (pulp) to be leached in hot (95°C) aqua regia and subjected to Induced Coupled Plasma (ICP) analysis with a final reading using mass spectrometry (MS).

The aqua regia digestion method used in 2011 (and for a short time after 2014) is generally considered unsuitable for supporting resource estimates unless there are studies showing that no significant grade bias exists for key elements. Additionally, the minimum detection limit for silver using the aqua regia digestion method is considered too high and therefore may not reflect the actual silver grades of some of

the mineralized zones at Eaglehead. Core samples were not analyzed for gold in 2011. There is no reference to the use of a check-assay procedure.

MMTS reviewed the 2011 analytical reports in detail and created a set of standardized plots to assess ACME's performance with regards to sample contamination (which potentially influenced the 2016 re-assaying program results by SGS) along with accuracy and reproducibility for all samples taken from holes DDH0096 to DDH0120 drilled that year.

Table 11-2 below details the 2011 QAQC insertion counts and % of total analyses reported. The 869 duplicates include field, coarse reject, and pulp duplicates (the reject and pulp duplicates being part of the lab internal QAQC protocol).

**Table 11-2: QAQC Insertion Rate - 2011**

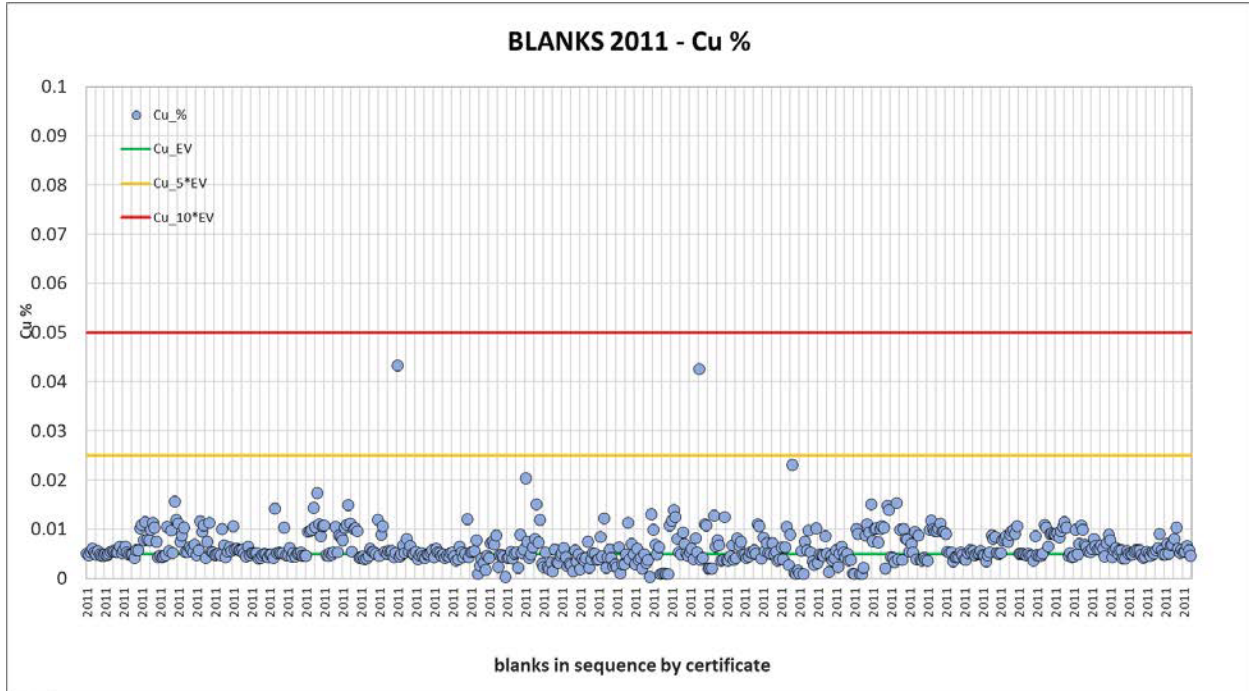
<b>Sample Types</b>	<b>Count</b>	<b>Percentage</b>
DH samples	7,348	82.1%
Blanks	605	6.8%
CRMs	129	1.4%
Duplicates	869	9.7%
Check assay	0	0.0%
QC total	1,603	17.9%
<b>Total</b>	<b>8,951</b>	<b>100.0%</b>

### **11.3.1 Blanks Performance - 2011**

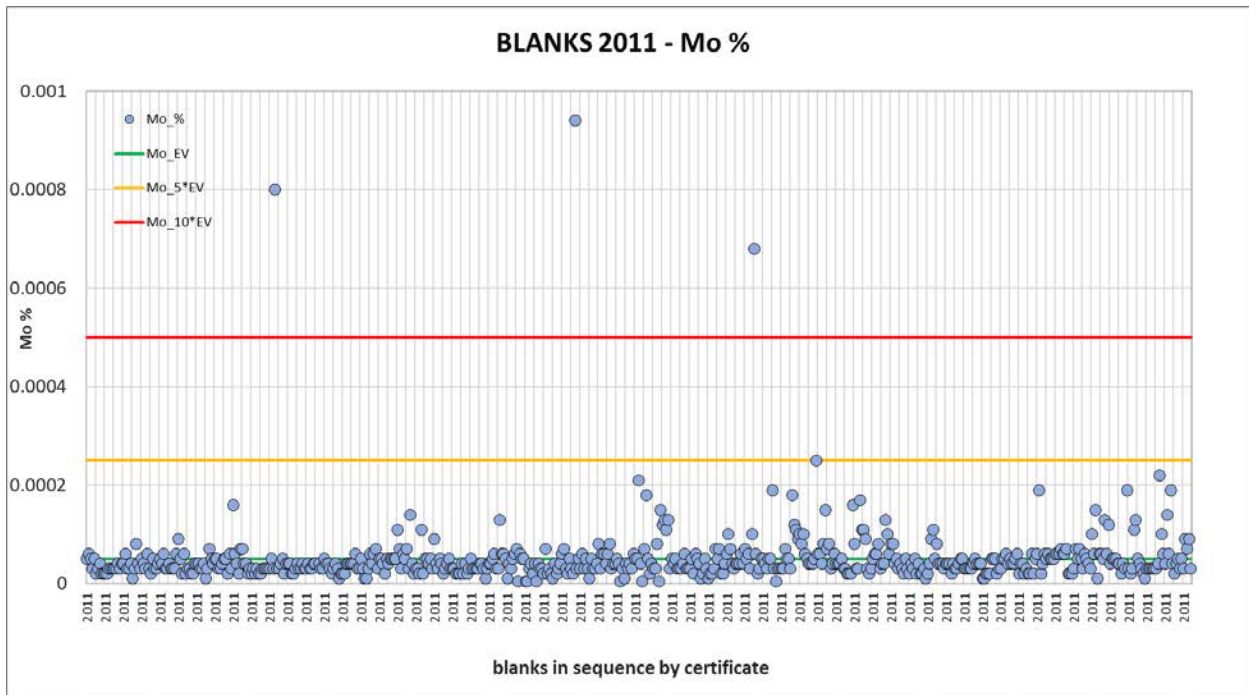
District Copper introduced two different blank materials into the sample stream: One appeared to be a silicate-rich rock (590 insertions) while the other was likely an only sporadically used limestone (15). MMTS does not have any further information about origin or fraction size but given the variation in weight from 0.3kg to 3.7kg, the utilized material is assumed coarse enough to have gone through ACME's crushing process.

For the following plots, the two blanks were combined (Figures below). Both appear to contain a certain natural background of approximately 50ppm Cu and 0.5ppm Mo, hence the warning and failure thresholds were adjusted to expected values (EV) from the commonly used multiples of the respective detection limits.

There were no failures in Cu blank data, and only 2 warnings at just >400ppm. The Mo data contains 3 failures that are likely to represent some weak contamination. Again, MMTS is not aware of re-run data for these and the surrounding drill core samples.

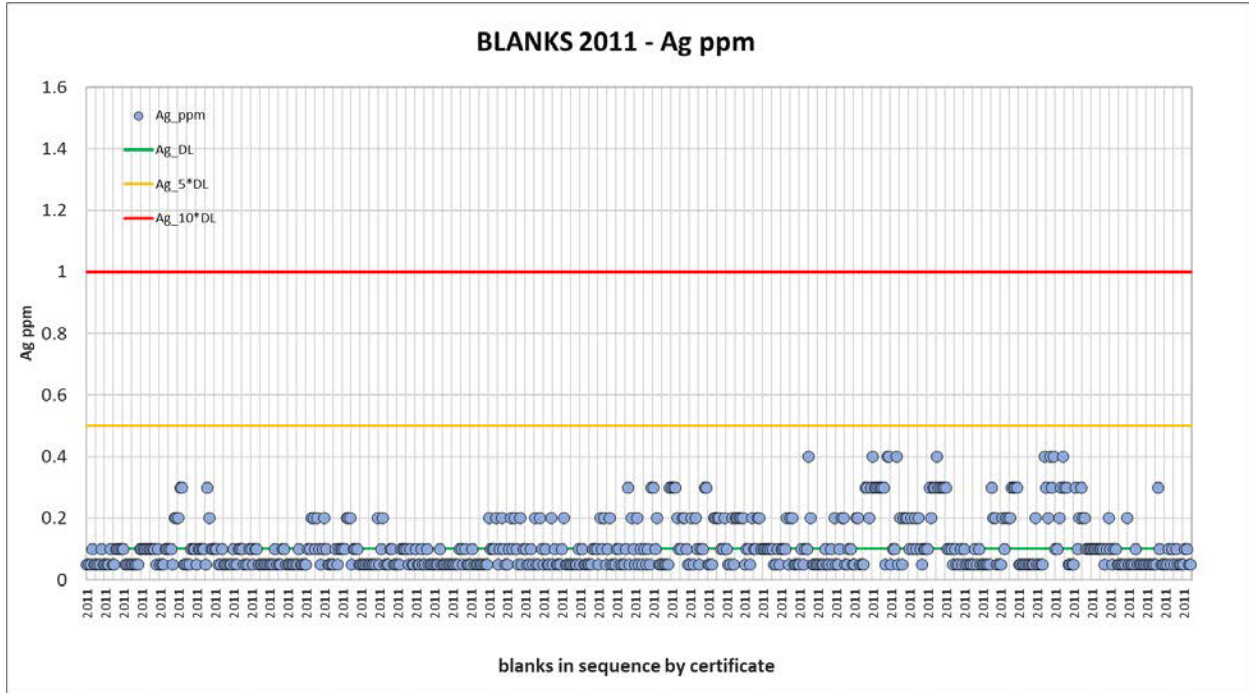


**Figure 11-1: Blanks from 2011 Program - Cu**



**Figure 11-2: Blanks from 2011 Program - Mo**

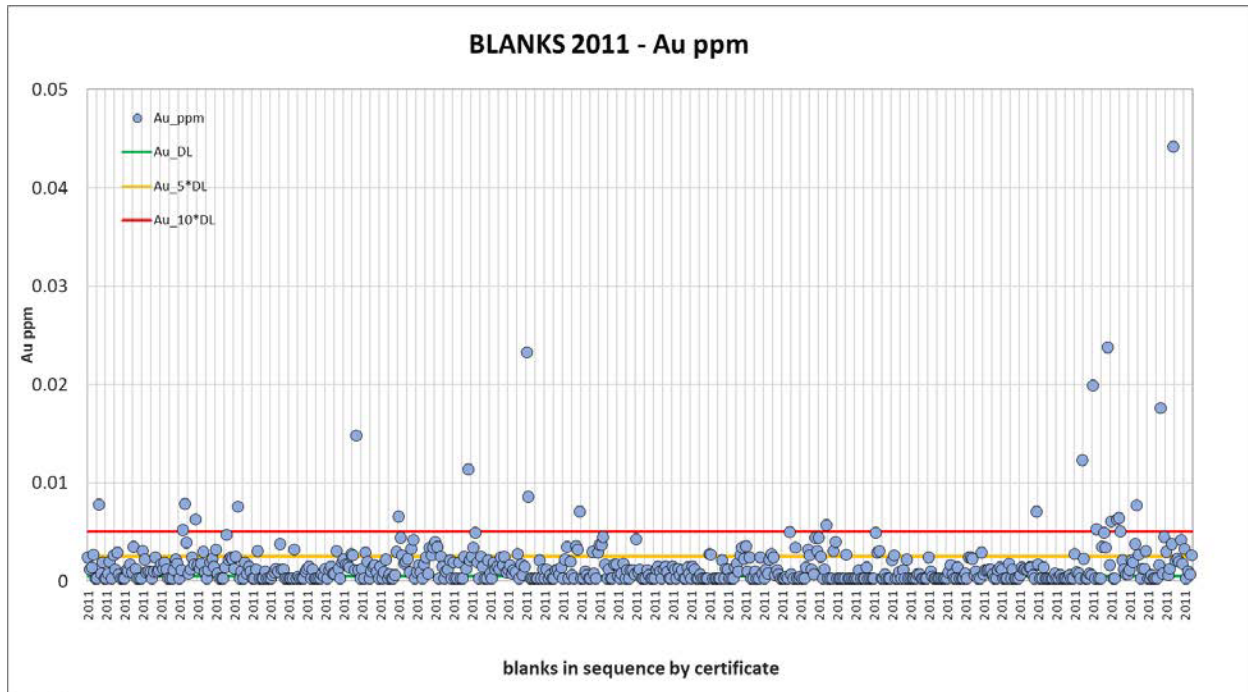
The two precious metals Ag and Au are also displaying a natural low-level background. The relatively high Ag detection limit in ACME's 1DX method (DL 0.1ppm) does not allow for contamination trends determination, if any, but no single blank exceeded the warning line of 0.5ppm.



**Figure 11-3: Blanks from 2011 Program - Ag**

In 2011, all Au data was produced by aqua regia digestion and ICP-MS finish instead of the industry-standard fire assay methodology. The detection limit at 0.5ppb is very low which resulted in a substantial number of blanks exceeding the 5\*DL warning and 10\*DL failure thresholds. MMTS is not aware of any certificates representing re-run data for these batches. However, again given the very low detection limit, MMTS does not view these failures as relevant to the overall data quality and subsequent resource modelling results.





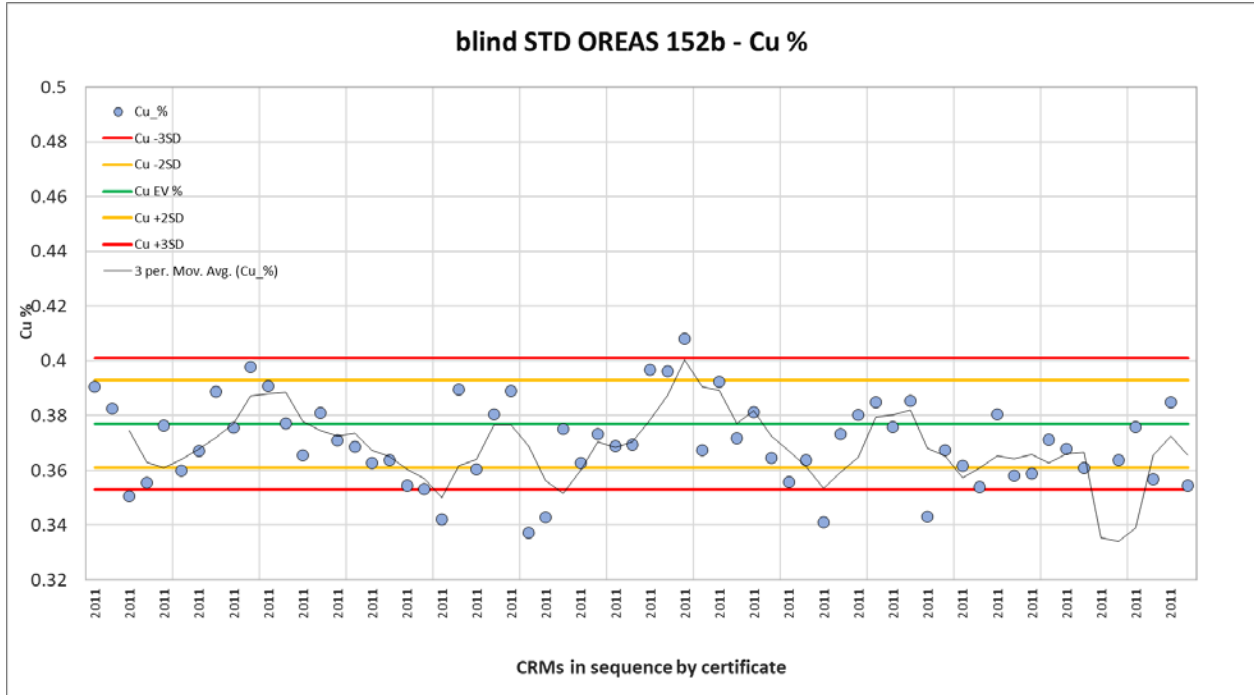
**Figure 11-4: Blanks from 2011 Program - Ag**

### 11.3.2 Standards Performance - 2011

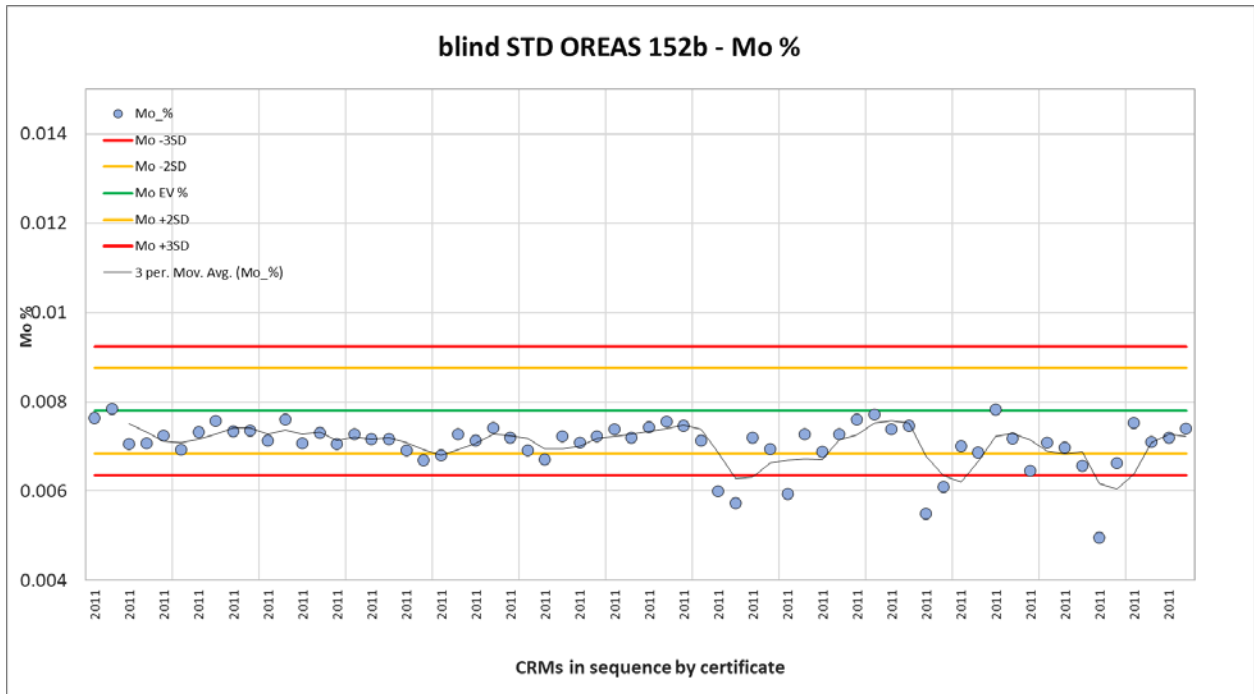
District Copper inserted two different blind standards (CRM) in 2011, both representing a porphyry copper system in Fiji. OREAS 152b is an overall suitable standard with aqua regia-certified values for Ag, Au, Cu, and Mo. OREAS 153a is only certified for Ag, Cu, and Mo via near-total digestion and Au via fire assay and is therefore not a fitting choice to assess accuracy of higher-grade material. The lack of a third standard to assess low, medium, and high-grade data range performance paired with the insertion of an unsuitable CRM leads MMTS to conclude that the 2011 ACME assay data accuracy is poorly controlled.

AMCE data generally under-reports on OREAS 152b, as is shown in Figure 11-5 through Figure 11-8. Standard deviation (SD) and certified mean/expected value (EV) lines in the plots represent the OREAS-provided calculations based on multiple inter-lab datasets. Ag averages 20% below certified inter-lab certified OREAS mean, while Au averages 0.107g/t versus 0.133g/t EV and Mo plots consistently 10% below EV. Cu exhibits substantial scatter with occasional negative failures but overall acceptable EV-matching average for the first half of the dataset, while the second half of the data displays a clear downward trend with multiple data exceeding the warning and failure thresholds on the negative side. This indicates that ACME 2011 data accuracy is a concern.

All 2011 drill samples were re-analysed by SGS in 2016 (see chapter 11.5).



**Figure 11-5: Standard Performance from 2011 Program - Cu**



**Figure 11-6: Standard Performance from 2011 Program - Mo**

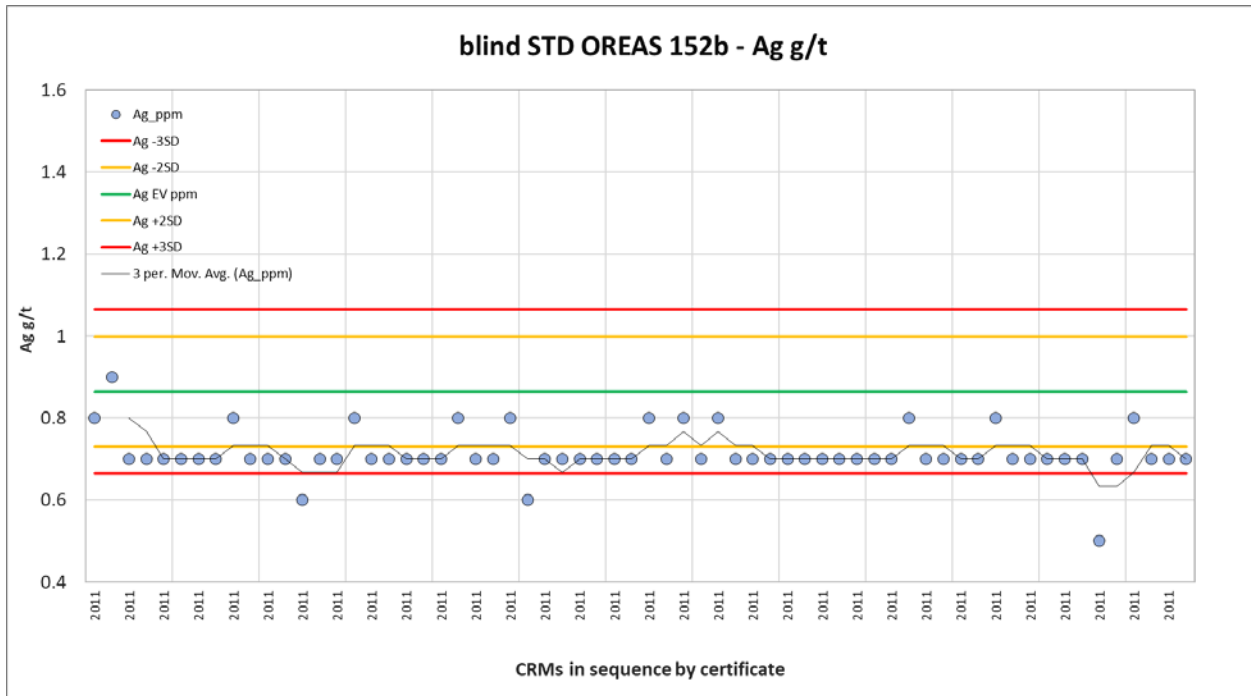


Figure 11-7: Standard Performance from 2011 Program - Au

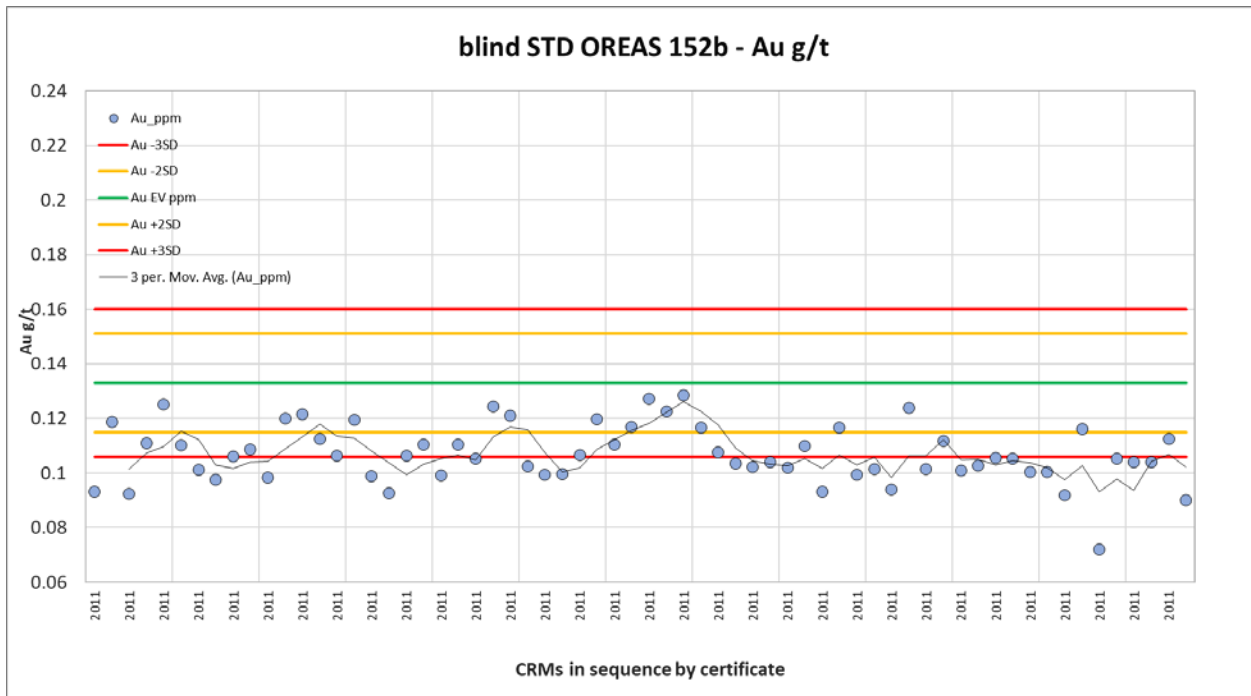
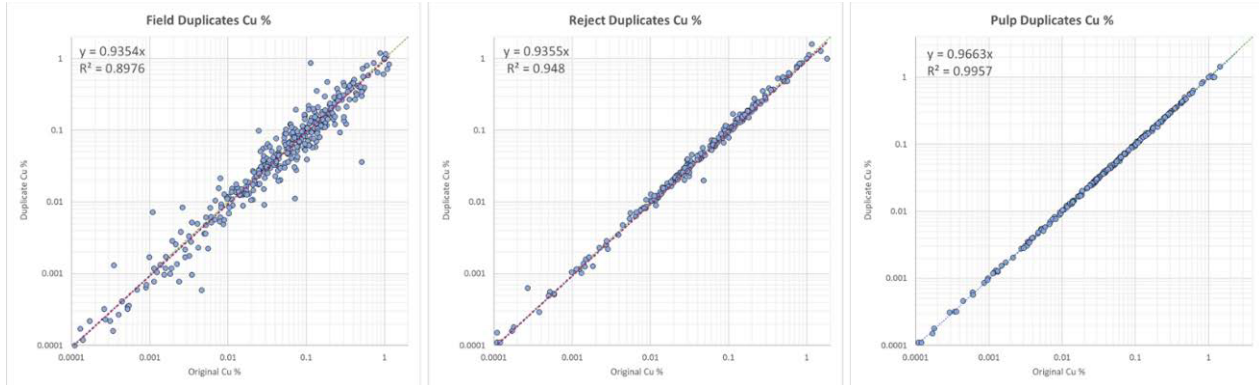


Figure 11-8: Standard Performance from 2011 Program - Ag

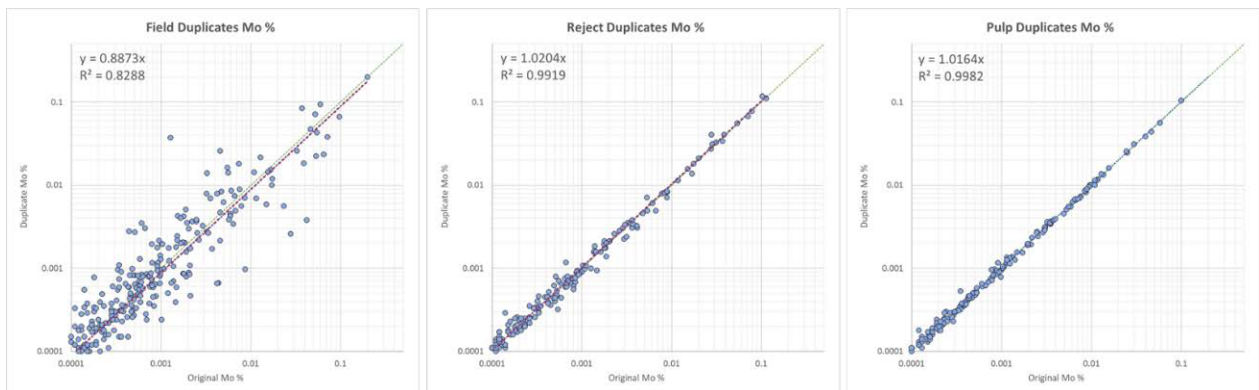
### 11.3.3 Duplicate Performance - 2011

The following log scatter plots demonstrate increasing correlation of original to duplicate assay results, from field duplicates to pulp duplicates, for all 4 metals but particularly Cu and Mo, with simple linear trendlines and R2. Au shows the weakest correlations overall because of substantial scatter in the very

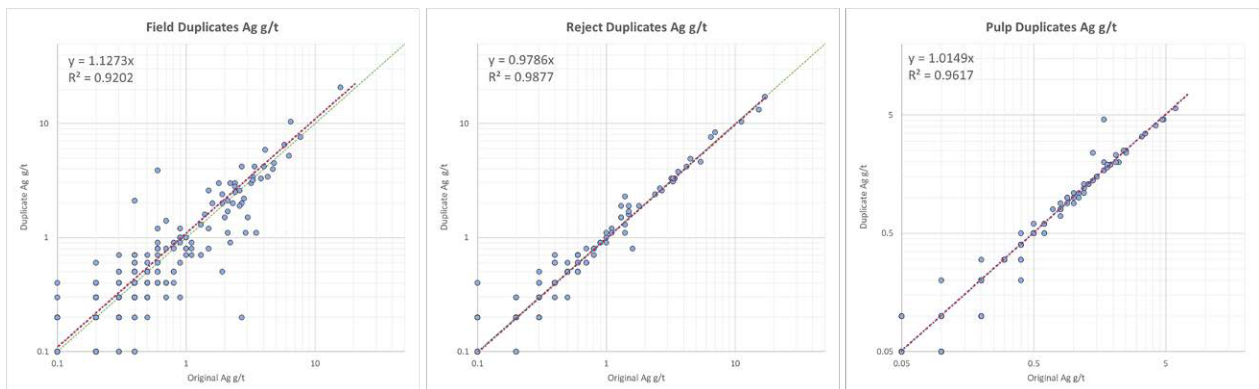
low to low grade bulk population of the data (0.001-0.2g/t). Overall, the plots suggest that the relative lack of precision in the field duplicates data is of geological nature as preparation and analytical errors, if any, are shown to be insignificant in the coarse reject and pulp duplicate data. MMTS finds the reproducibility control for the 2011 ACME data to be acceptable.



**Figure 11-9: Duplicate Performance from 2011 Program – Cu**



**Figure 11-10: Duplicate Performance from 2011 Program – Mo**



**Figure 11-11: Duplicate Performance from 2011 Program – Ag**

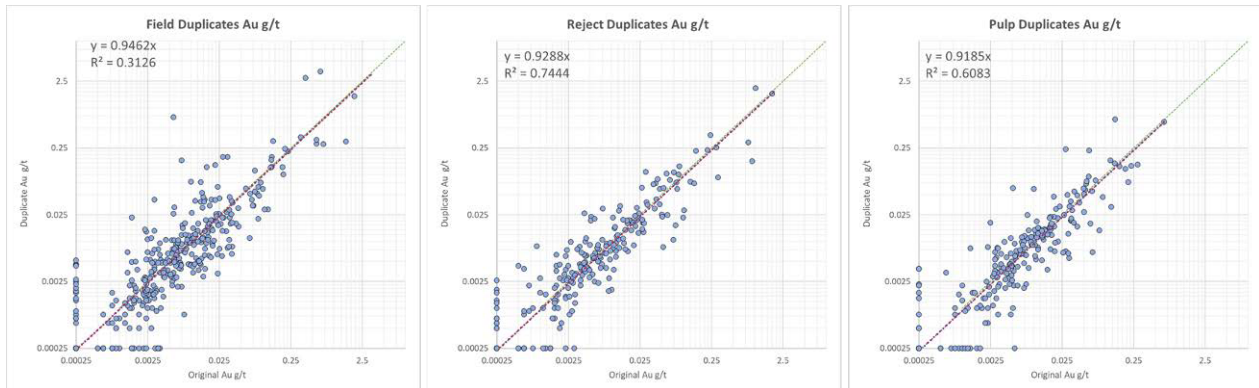


Figure 11-12: Duplicate Performance from 2011 Program – Au

### 11.4 2014 and 2015 Programs

Detailed information on the 2014 and 2015 drilling has been reported by Quist (2015). In 2016, a review of sampling procedures and QAQC protocols was performed by Amec Foster Wheeler (2016), discussion of data verification, including findings by Amec Foster Wheeler (2016).

MMTS created scatter plots for the QAQC portion of the assay data to review SGS’s performance on contamination, accuracy, and precision, utilizing 2023 compiled data. The numbers in the QAQC insertion rates Table 11-3 are based MMTS’s recent data compilation.

Table 11-3: QAQC Insertion Rate – 2014 - 2015

Sample Type	2014 drilling		2015 drilling		2015 resampling		Total	
	Count	% of total	Count	% of total	Count	% of total	Count	% of total
DH samples	1,070	73.5%	578	70.8%	238	78.0%	1,886	73.2%
Blanks	90	6.2%	35	4.3%	15	4.9%	140	5.4%
CRMs	61	4.2%	35	4.3%	14	4.6%	110	4.3%
Duplicates	177	12.2%	110	13.5%	38	12.5%	325	12.6%
Check assay	58	4.0%	58	7.1%	0	0.0%	116	4.5%
QC total	386	26.5%	238	29.2%	67	22.0%	691	26.8%
<b>Total</b>	<b>1,456</b>	<b>100.0%</b>	<b>816</b>	<b>100.0%</b>	<b>305</b>	<b>100.0%</b>	<b>2,577</b>	<b>100.0%</b>

The four holes drilled in 2014 were HQ-diameter (DDH0121 to DDH0124); two of these holes were designated as metallurgical holes and were drilled in the centre of the Bornite and East zones. The two holes drilled in 2015 were NQ-diameter (DDH0125 and DDH0126).

After logging, drill core was split and half the core was placed in sample bag with a uniquely numbered tag, and tightly closed with a zap-strap. A sample interval of 2.0m was used for the 2014 and 2015 drill programs. The remaining half core was returned to its proper location in the core box; core boxes were either cross-staked or placed in core racks. Bagged samples were weighed and placed in rice bags with several other samples. When suitably heavy, each rice bag was securely closed with a zap strap and placed in a mega-bag along with a dossier of all the samples present. The mega-bags were flown by helicopter to Dease Lake where they were temporarily stored at the Pacific Western Helicopter base. Sample shipments were subsequently shipped by commercial carrier to the laboratory facilities of SGS Canada

Inc. (“SGS”) in Burnaby, British Columbia. The remaining half core was returned to its proper location in the core box; core boxes were either cross-staked or placed in core racks.

Three different certified reference material (CRM) standards (representing low-grade, medium-grade and high-grade polymetallic mineralization) were inserted into the sample stream by the core logging geologist. Standards were inserted every 20 samples. Crushed limestone was used as blank material; blanks were inserted every 10 samples for the 2014 metallurgical holes. Core duplicates were collected for two of the 2014 holes. Overall, the insertion rate for QAQC samples was approximately 15% (Quist, 2015) which is consistent with industry best management practices. In 2015, the QAQC procedures were improved and standardized for all future drilling programs. In 2015, four different CRM standards (OREAS 151b, OREAS 152b, OREAS 501b and OREAS 503b), blank material (consisting of fine silica sand), and core duplicates were inserted into the sample stream at an overall rate of over 10% and submitted to SGS.

At SGS, following sample preparation (prep code PRP89\_CM), samples of drillholes DDH0121 to DDH0125 were analyzed utilizing an aqua regia digestion with ICP AES/MS finish (SGS code GE-ICM14B), then switching to a near-total 4-acid digestion with ICP AES/MS (SGS code GE-ICM40b) for the second half of hole DDH0125 and then DDH0126 as well as 3 re-sampled historical holes (see below)

All samples were assayed for gold using fire assay with atomic absorption spectroscopy (SGS code GE\_FAA313). Samples returning values >0.8% Cu or >1% Mo were re-analyzed using ICP90Q, samples returning values >10 ppm Au were re-analyzed using fire assay method FAG303, and samples returning >100 ppm Ag were re-analyzed using fire assay method FAG313 (Stewart, 2016).

#### **11.4.1 Core Re-logging and Re-sampling procedures**

The historical drilling, sampling method, analytical (digestion and analytical method) and QAQC method (if any) used to verify the accuracy of the reported historical analytical results at that time are either partially available or not available. In the absence of this information, a considerable amount of the project data base is incomplete. Historical holes drilled in the Pass zone as well as in other zones were not completely sampled, in some instances (based on core log descriptions), leaving long intervals of mineralized core un-sampled. Core logging and core sampling procedures, and QAQC methods utilized in drilling programs prior to 2014 have produced numerous inconsistencies in the data base for the Project.

Based on the inconsistencies and the lack of other detailed information (including trace element geochemistry) District Copper initiated a program of re-logging, re-sampling of previously sampled core and sampling of previously unsampled core to upgrade the data to current best industry management standards (Stewart, 2016). For samples from the historical drillholes, if the core was NQ diameter, the sample interval was cut using a core saw and the remaining half core was placed back in the core boxes. If the core size was BQ, the core was split using a mechanical splitter and one half of the core was placed back in the core boxes. When sampling of previously sampled BQ or NQ core, the core was quarter split to obtain the sample for analytical purposes. The sample interval used for historical drill core was constrained to historical sample intervals where possible. Where the historical core was not previously sampled a sample interval of 2m was maintained.

In 2015, historical holes DDH0013, DDH0023, and DDH0053 were resampled and analyzed, and in 2016 the company completed a massive resampling and re-assaying program across 102 historical drillholes (see Section 11.5).

### 11.4.2 Blanks Performance – 2014-2015

For the 2014 drilling, as well as the resampling of 3 historical holes in 2015, crushed limestone was utilized for contamination control, generally ca. 1kg of material. In 2015, this was replaced by approx. 150g packages of likely purchased fine silica sand, bypassing the crushing stage in the lab but increasing the abrasion effect during pulverization.

The switch in blank material can be observed in plots xxx and xxx: It appears that the silica sand used in 2015 picks up a very small amount of Ag during pulverization (or contained some background Ag itself), while the opposite is the case in the Mo plot xxx, where the 2015 is overwhelmingly around or even below detection limit.

MMTS has no concerns about contamination in this set of data. The 10\*DL Cu exceedance in plot xxx is likely a function of the very low detection limit of 0.5ppm and a weak background Cu in the source limestone. The highest Cu failure is <40ppm which can be considered inconsequential, similar for the 3 Mo failures which do not exceed 4ppm.

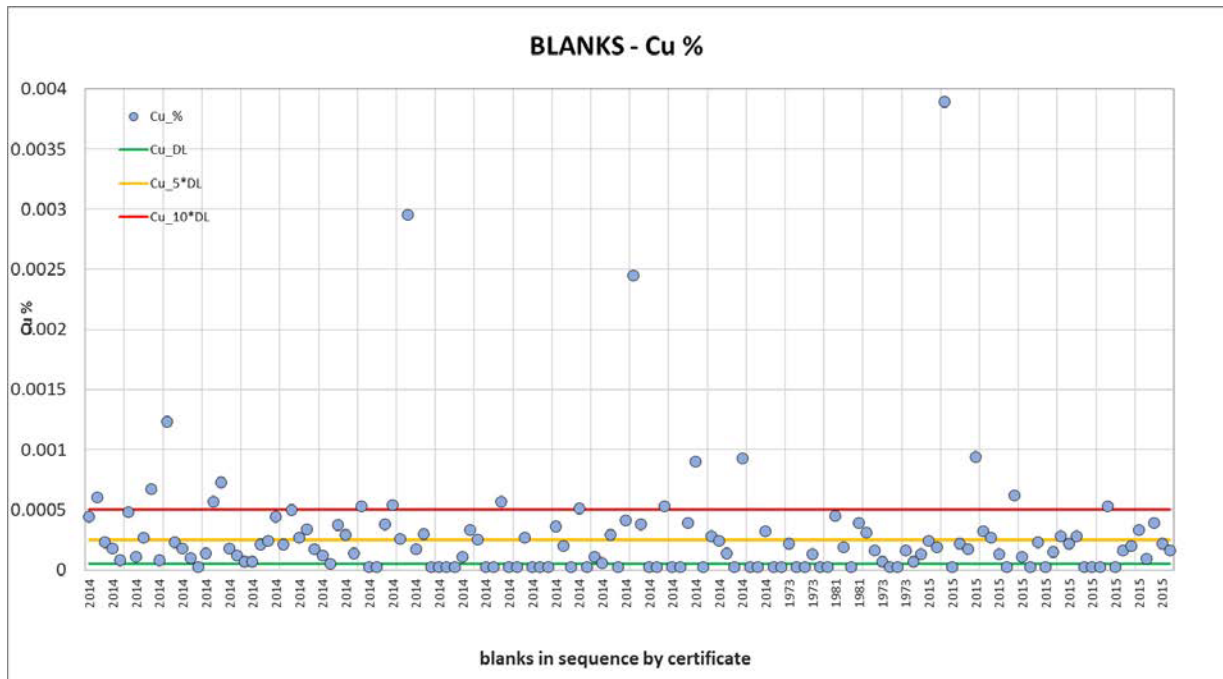


Figure 11-13: Blanks from 2014-2015 Program - Cu

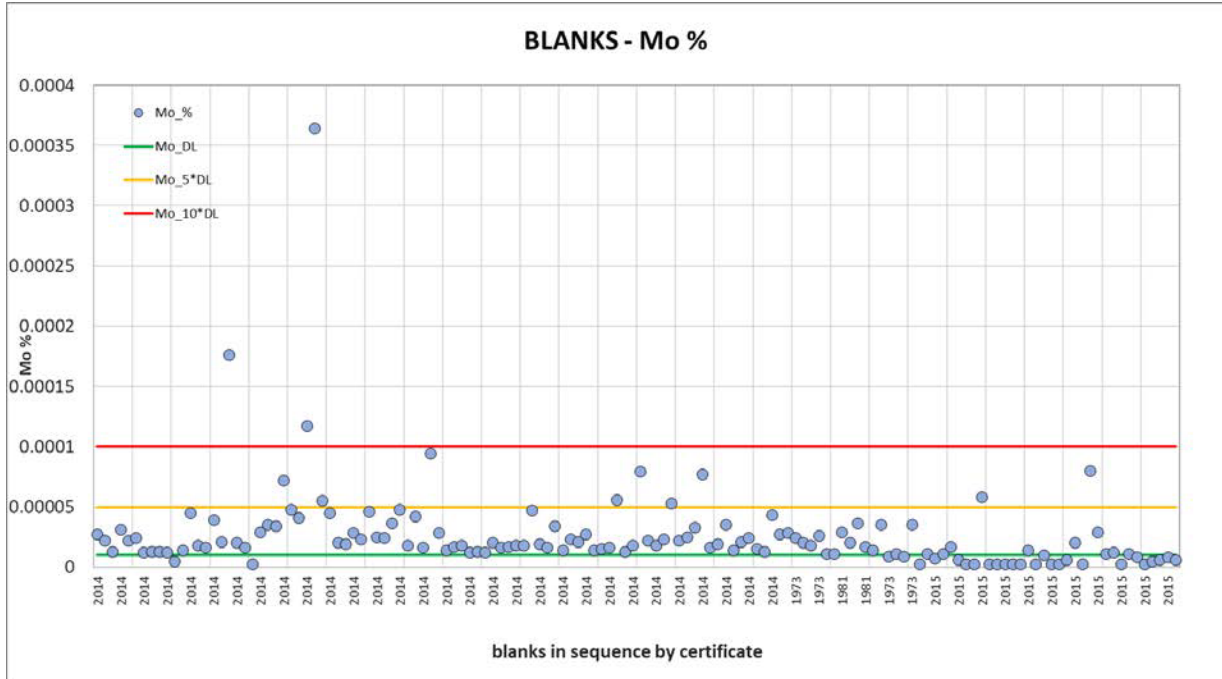


Figure 11-14: Blanks from 2014-2015 Program - Mo

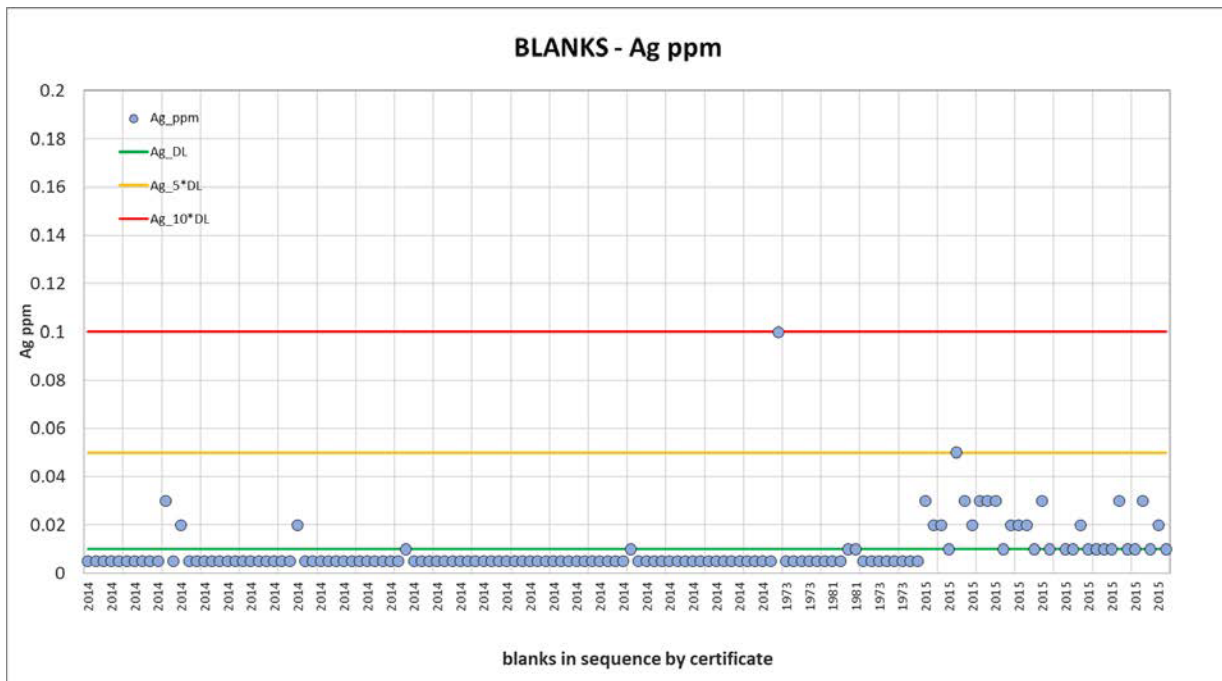
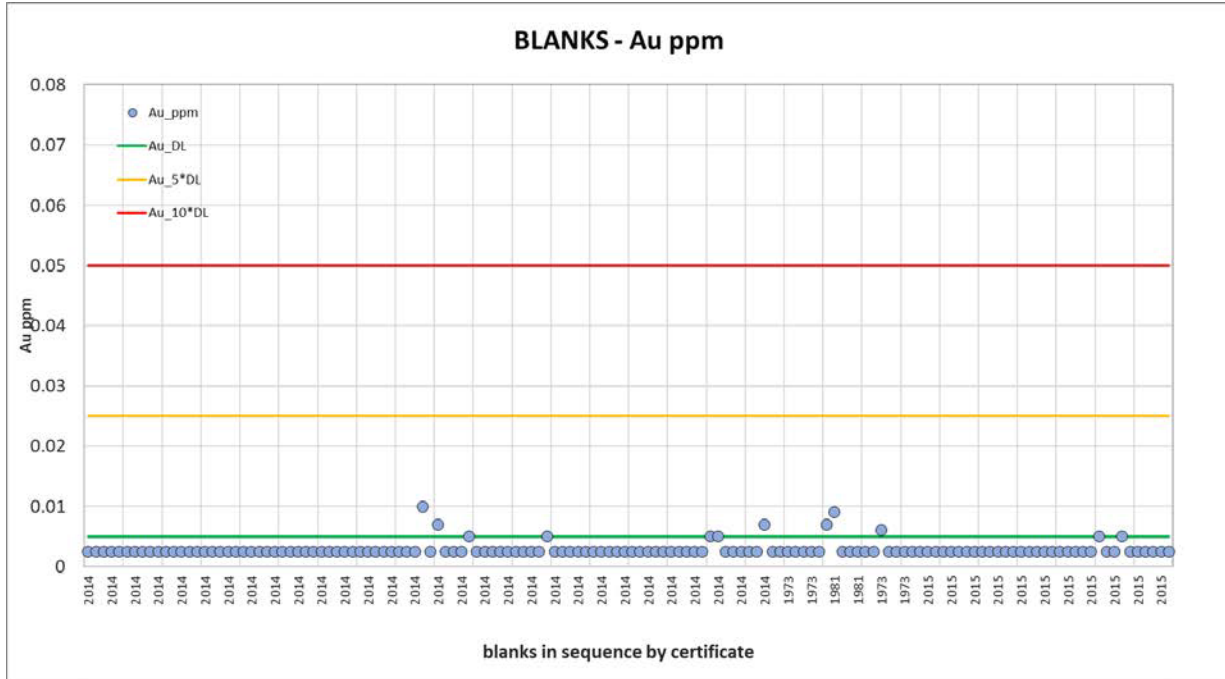


Figure 11-15: Blanks from 2014-2015 Program - Ag





**Figure 11-16: Blanks from 2014-2015 Program - Au**

### 11.4.3 Standards Performance – 2014-2015

A total of 110 standards were inserted into the sample stream in 2014-2015 (see Table 11-3) and normalized into a Process Control Chart (PCC) plot to assess (Figure 11-17 through Figure 11-20). The 5 different standards have been well selected for grade range and are all certified for fire assay Au and both aqua regia and 4-acid Ag, Cu, and Mo. The 2015 data has been normalized using 4-acid certified means and SDs.

These four plots illustrate good Standard results for all four elements in the 2014-2015 drill program.

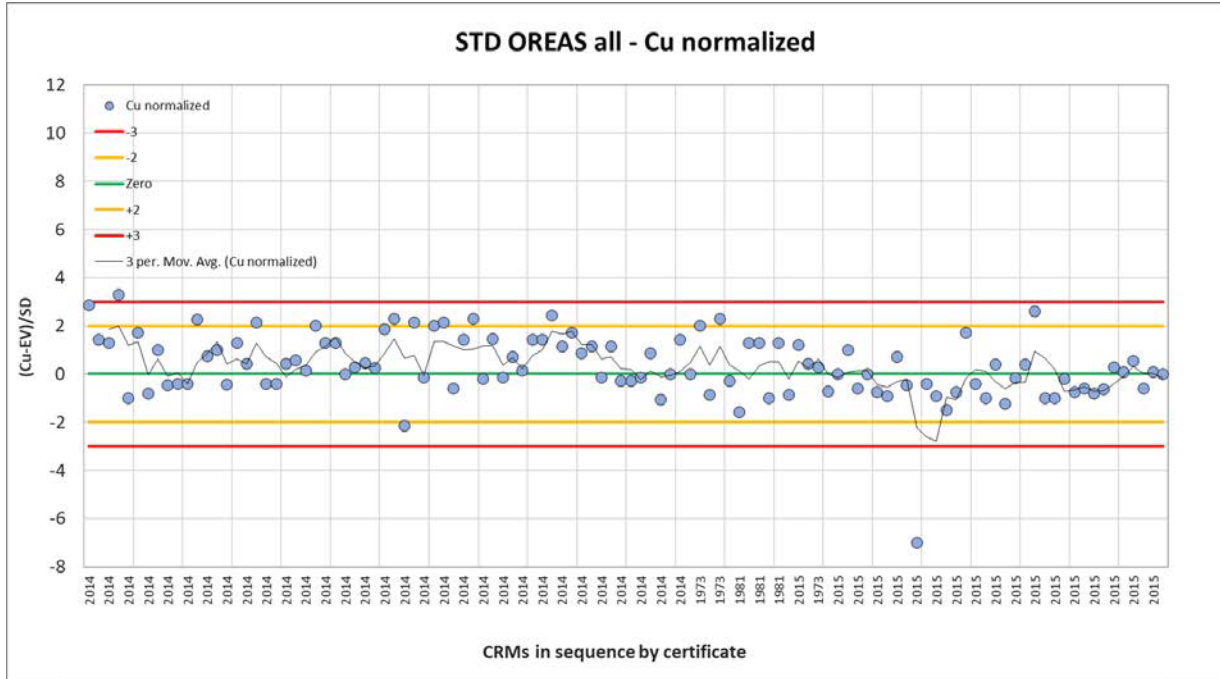


Figure 11-17: Standard Performance from 2014-2015 Program - Cu

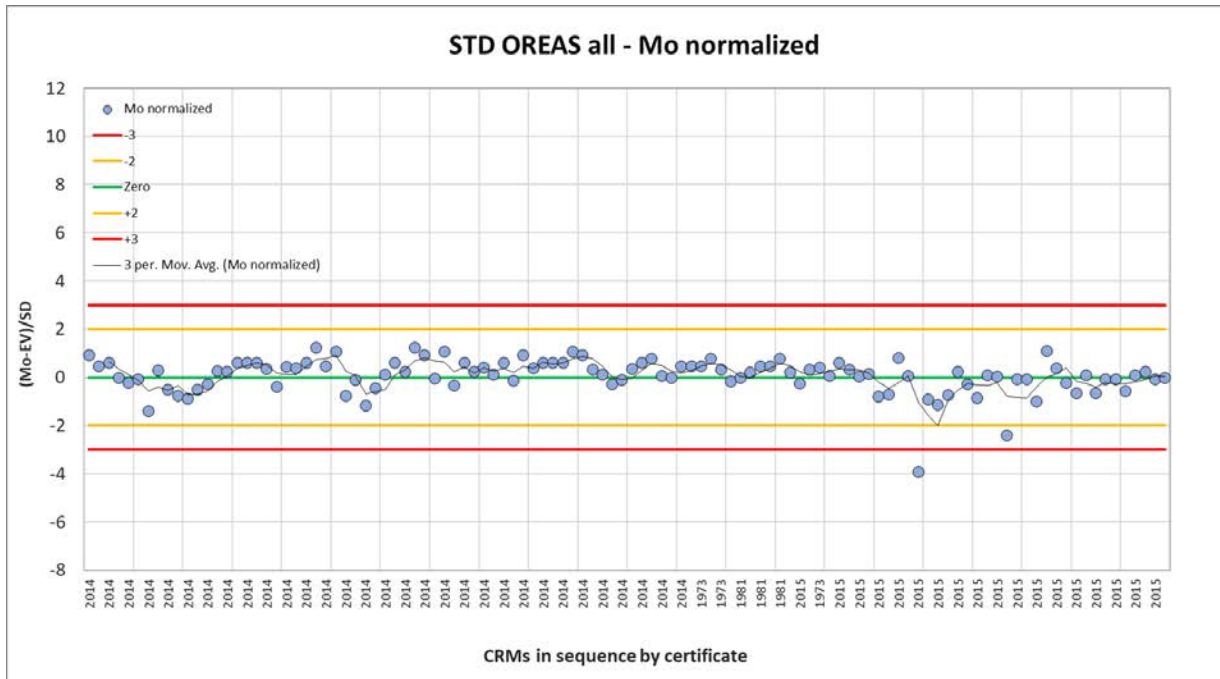


Figure 11-18: Standard Performance from 2014-2015 Program - Mo

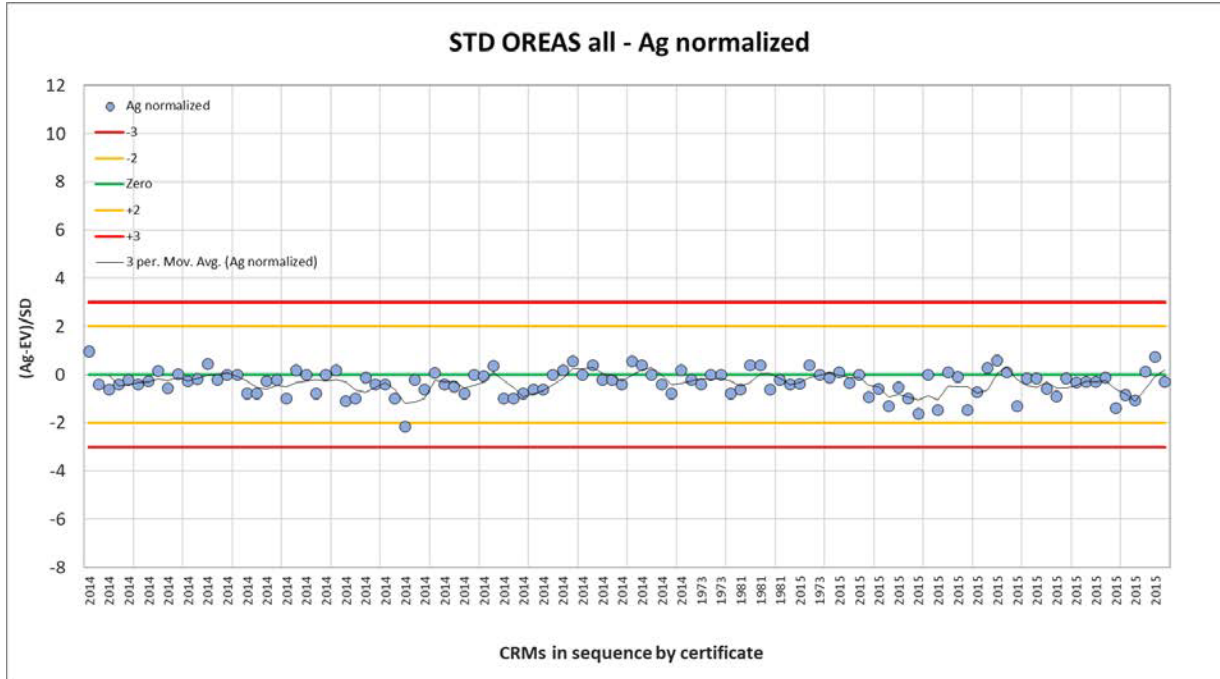


Figure 11-19: Standard Performance from 2014-2015 Program - Ag

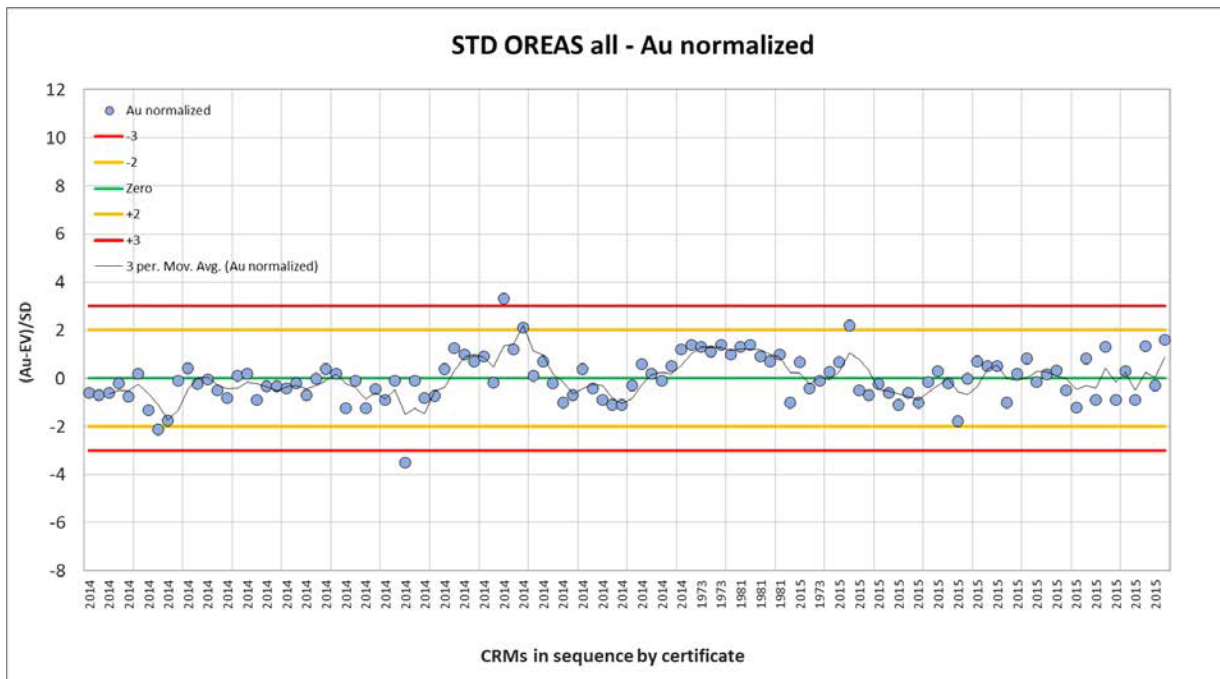
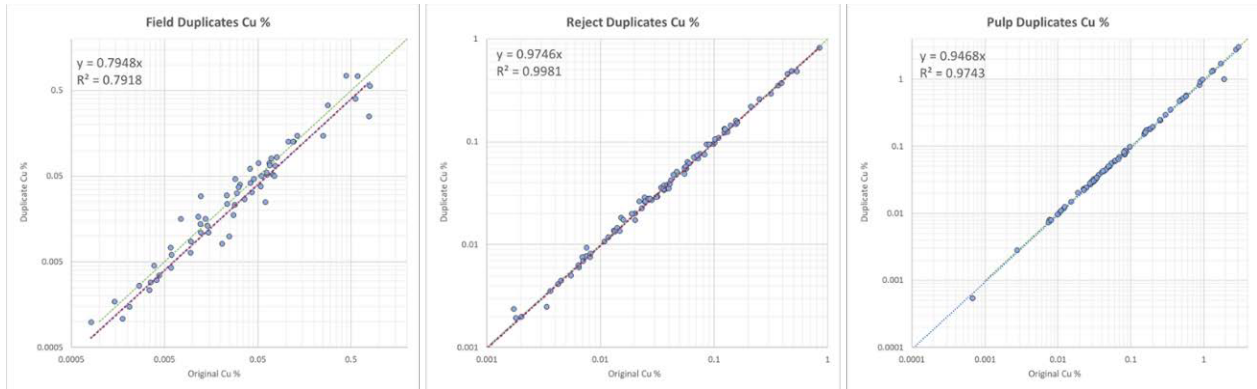


Figure 11-20: Standard Performance from 2014-2015 Program - Au

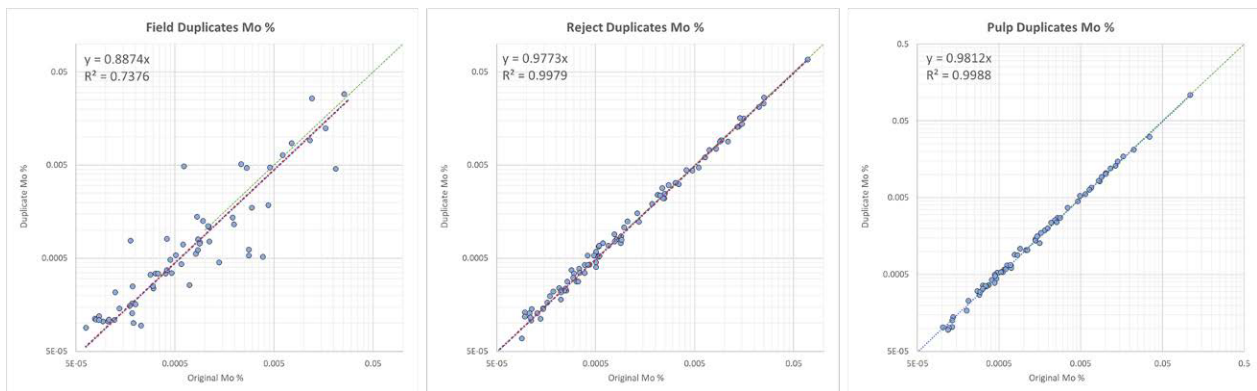
#### 11.4.4 Duplicates Performance – 2014-2015 Program

As was the case for the 2011 ACME data, MMTS used the lab-internal coarse reject and pulp duplicate data to assess precision throughout the sampling, size reducing, and analysis process.

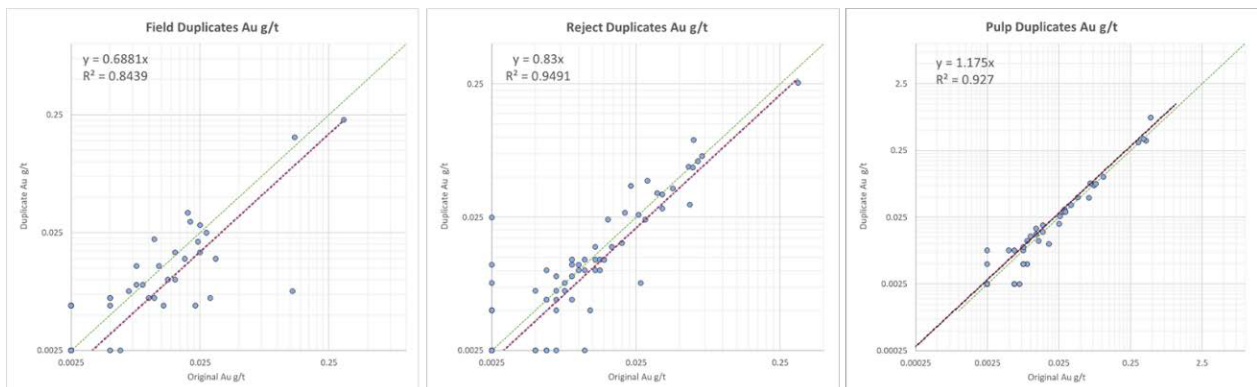
The progression of the correlation coefficient ( $R^2$ ) from 0.74-0.97 to 0.92-0.99 for the group of metals considered in this report documents that no significant and systematic errors were introduced during preparation or analysis. Initially duplicate-positive (Ag) and original-positive signals in the field duplicates data are being strongly influenced by single higher-grade sample pairs which are interpreted as natural variability within the sampled lithology. MMTS considers this data as acceptable.



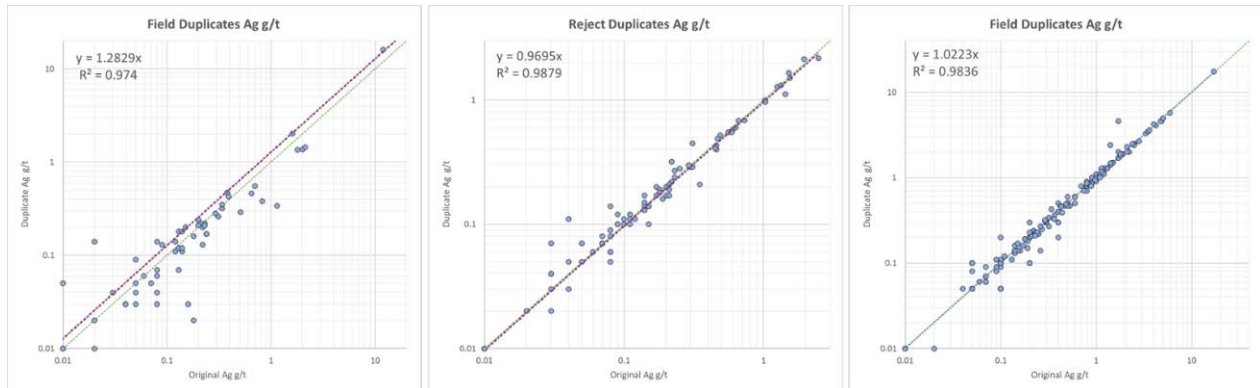
**Figure 11-21: Duplicate Performance from 2014-2015 Program – Cu**



**Figure 11-22: Duplicate Performance from 2014-2015 Program – Mo**



**Figure 11-23: Duplicate Performance from 2014-2015 Program - Au**

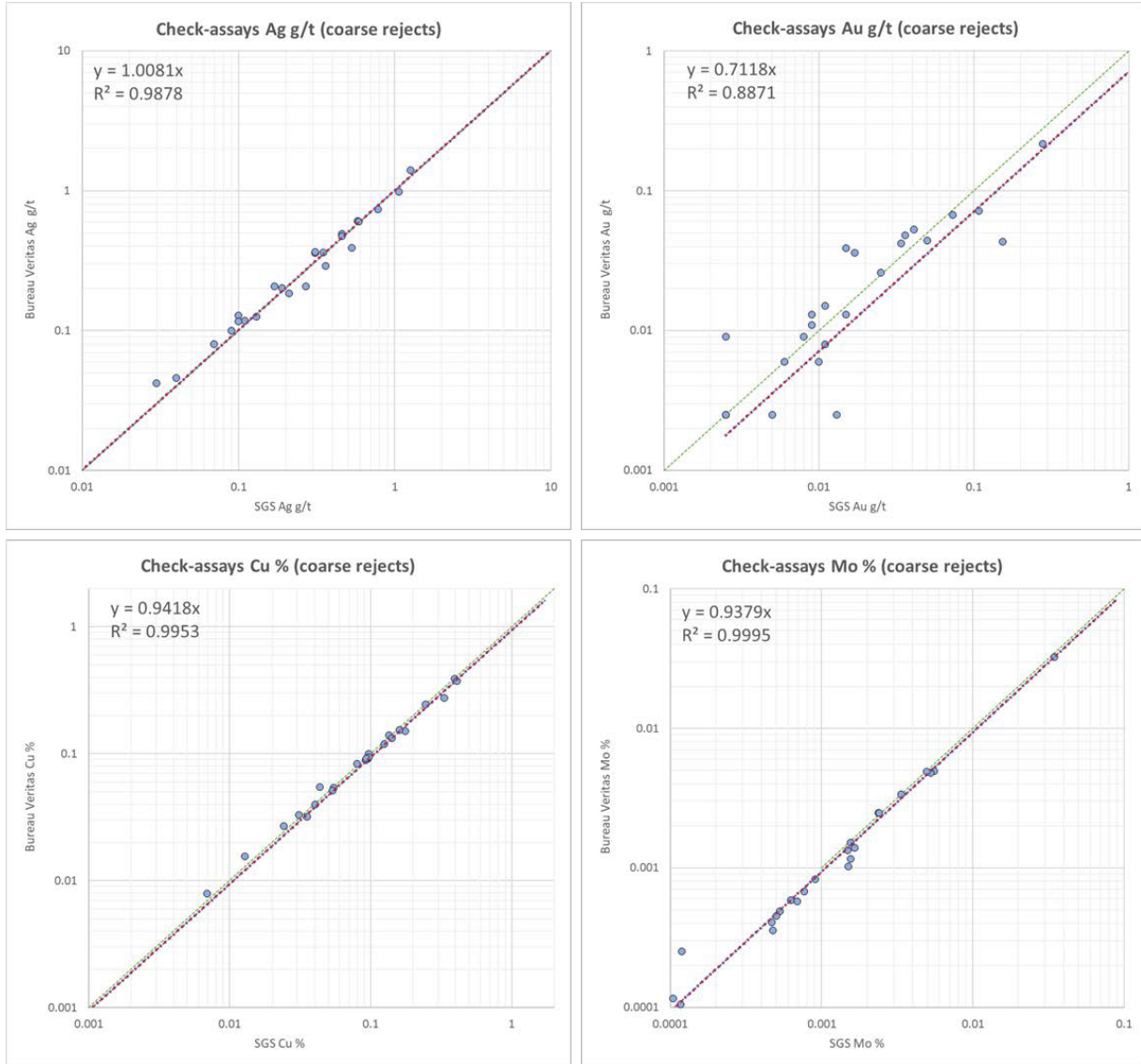


**Figure 11-24: Duplicate Performance from 2014-2015 Program - Ag**

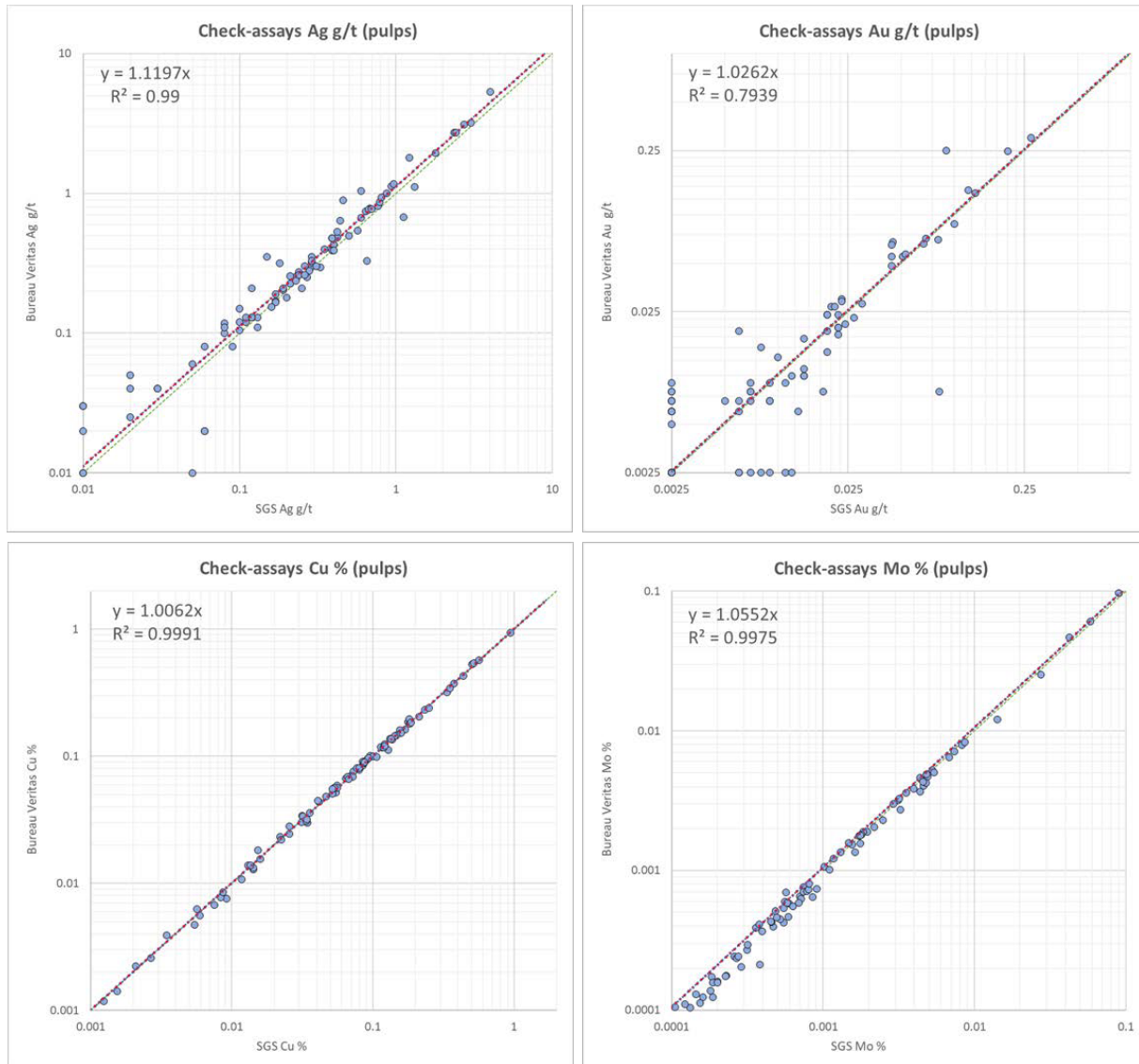
#### 11.4.5 Check-assay Performance – 2014-2015

Representative sub-sets of samples of the 2014-2015 drilling campaigns were selected and sent to Bureau Veritas in Vancouver, BC, to perform both fire assay Au (method FA430) and full suite aqua regia digestion and analysis (method AQ250) for check-assaying purposes.

Pulp material (91 samples) and coarse reject material (25) were utilized, approaching 5% of all samples analysed during the two campaigns. The correlations as represented by  $R^2$  are overall good (Au) to very good, with only the pulp Mo data in Figure 11-26 indicating a weak but consistent original (SGS)-positive trend between 5 and 100ppm, likely an expression of the SGS data being generated via the stronger, more complete digestion. MMTS finds the data acceptable.



**Figure 11-25: Check Assays of Coarse Rejects – 2014-2015**



**Figure 11-26: Check Assays of Pulps – 2014-2015**

### 11.5 2016-2018 Resampling of Historical Core and re-assaying of pulps

In two separate assessment reports, Stewart (2016) and Stewart (2018) provide full detail on the resampling and re-analyzing projects completed at Eaglehead. MMTS reviewed the QAQC data of this period and created a set of new graphs confirming and complementing the acceptable contamination, accuracy, and reproducibility reported at the time, based on assay data independently compiled in 2023.

In late 2015 and through 2016, then again in 2018, District Copper completed extensive relogging and resampling/analysing programs that effectively included all historical drill core still available. The sampled material was sent to SGS in Vancouver for Ag, Au, Cu, and Mo analysis along with a full suite of other elements also reported (GE-ICM40B and GE-FAA313, respectively).

Also in 2016, existing pulp material from 2006-2011 drilling campaigns was resubmitted and reanalyzed by SGS as well, effectively replacing the existing aqua regia data of 2011 including Au (see Section 11.3). Fire assay data was being reported in separate certificates.

The plots in this section aim to demonstrate data consistency despite the utilization of previously prepped material (pulp). Standard reproducibility control exists for pulps of 2011 (Section 11.3) but not for material from 2006-2008 (approx. 2,300 samples). Table 11-4 sums up the QA/QC insertion rates.

**Table 11-4: QAQC Insertion Rate – 2015-2018 Program**

Sample Type	2015-2016		2018		Total	
	Count	% of total	Count	% of total	Count	% of total
DH samples	12,491	83.3%	832	88.2%	13,323	83.6%
blanks	881	5.9%	24	2.5%	905	5.7%
CRMs	461	3.1%	75	8.0%	536	3.4%
duplicates	1,165	7.8%	12	1.3%	1,177	7.4%
check assay	0	0.0%	0	0.0%	0	0.0%
QC total	2,507	16.7%	111	11.8%	2,618	16.4%
<b>Total</b>	<b>14,998</b>	<b>100.0%</b>	<b>943</b>	<b>100.0%</b>	<b>15,941</b>	<b>100.0%</b>

### 11.5.1 Blanks Performance – 2015-2018

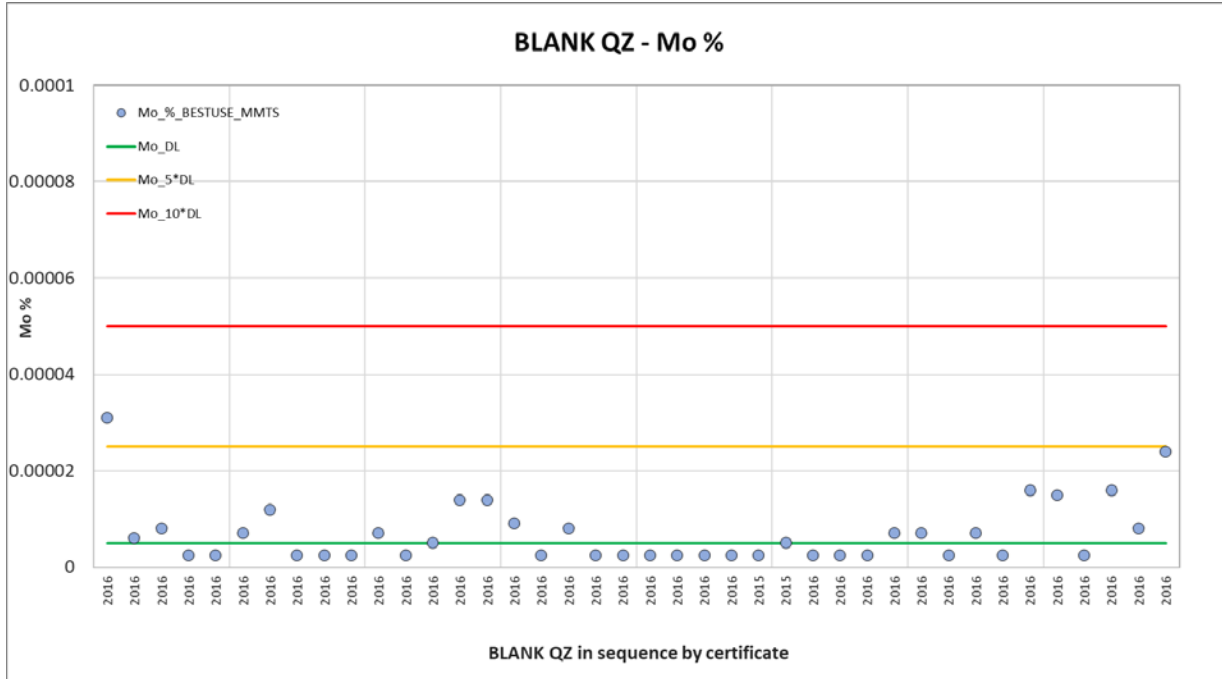
A total of 905 blanks consisting of 4-5 different materials are present in the resampling and re-assaying data set, either pre-existing from the 2011 QA/QC program, newly inserted during resampling to control contamination during preparation of core samples, or newly inserted along with CRMs for the 2006-2008 pulps for which the original QA/QC protocols were not available. MMTS has reviewed the performance of these blanks over time and for each metal under consideration. Only a selection of the blank plots will be included in this report.

The analysis of the pre-existing blanks from 2011 confirmed the results from Section 11.3: no obvious contamination patterns or significant outliers. These plots are not included in this report.

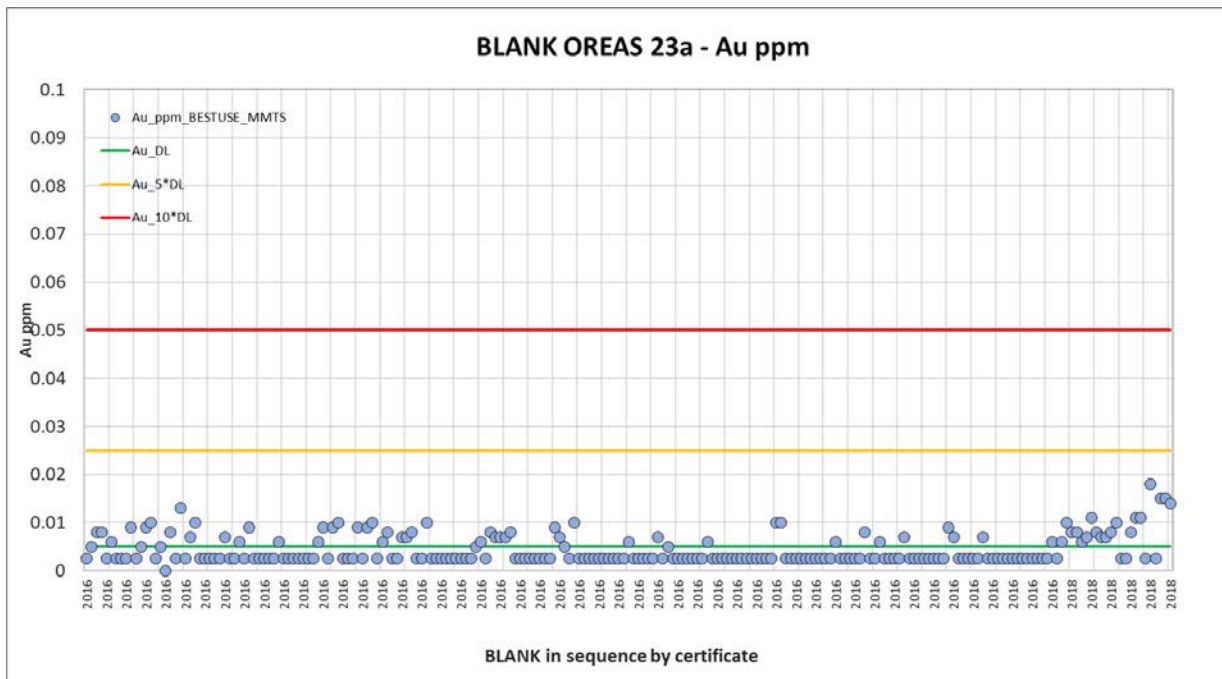
A likely purchased quartz blank was introduced 40 times in the 2015-2016 parts of the resampling of historical core. Again, no significant contamination was observed for either metal. Figure 11-27 shows the Mo performance as an example.

OREAS 23a blanks were introduced into the resampling stream of historical core as well as the re-analysis stream of 2006-2008. MMTS did not find any concerning trends or outliers in any of the 4 metals, though a small population of elevated Au values from the 2018 resampling program was noted (see Figure 11-28 for Au in OREAS 23a).





**Figure 11-27: Blank Performance from 2015-2018 Program - Mo**



**Figure 11-28: Blank Performance from 2015 - 2018 Program - Au**

The 2018 blank insertion rate is too low at 2.5% of all data but overall, the 5.7% of blanks within the dataset are acceptable. MMTS recommends utilizing coarser blank material to have the crushing stage of the sample preparation included.

### 11.5.2 Standards Performance – 2015-2018

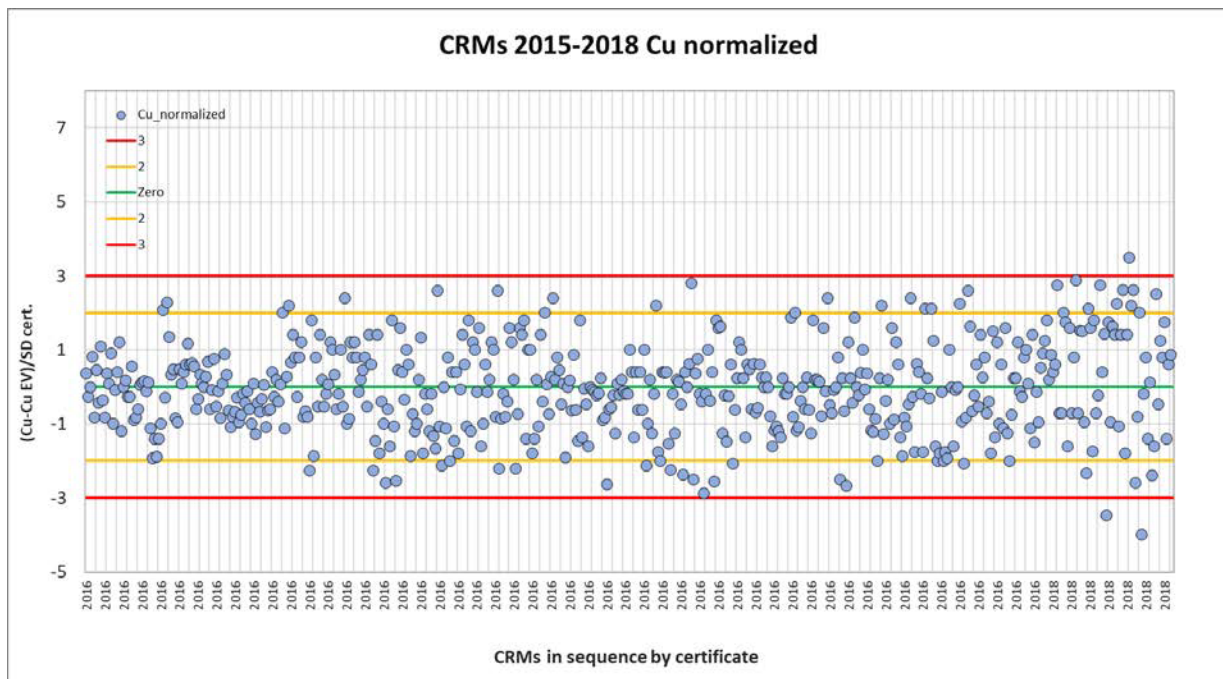
8 OREAS and 1 CDN certified reference materials (CRM) were present in the resampling and re-assaying data set. CDN-CM-31 is not certified for fire assay Au and was excluded from the following plots. OREAS 501c was only inserted once, which was probably an error during the sampling and bagging process.

For OREAS 152b it appears that two different populations are present, most prominent in Ag values, which are noticeably and consistently lower in the 2011-inserted material (0.68 g/t) versus the 2016-inserted ones (0.89 g/t). MMTS has excluded the 2011 OREAS 152b data from the PCC plot below.

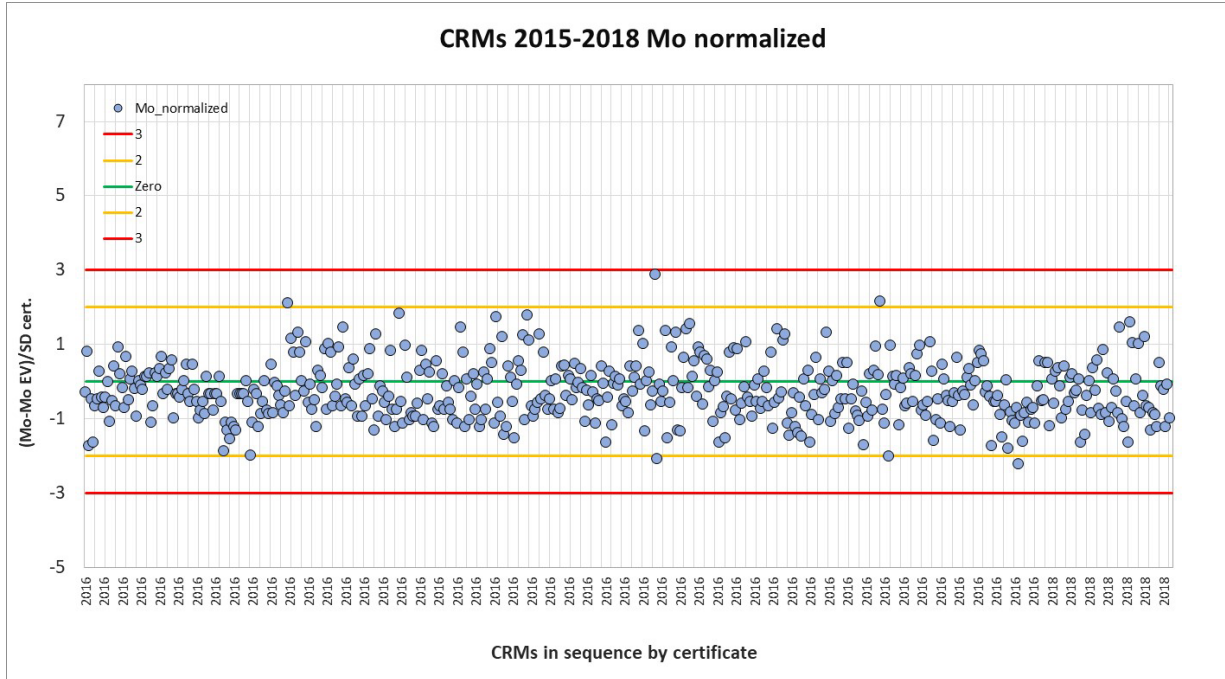
To combine all standard assay data into one plot per metal, MMTS normalized the data using the CRM-provided inter-lab calculated means/expected values and standard deviations for 4-acid (Ag, Cu, Mo) and fire assay Au.

Gaps in the normalized PCC 2016 data plots below are being caused by 2011-inserted OREAS 153a not being certified for 4-acid Ag and not being analyzed for Au.

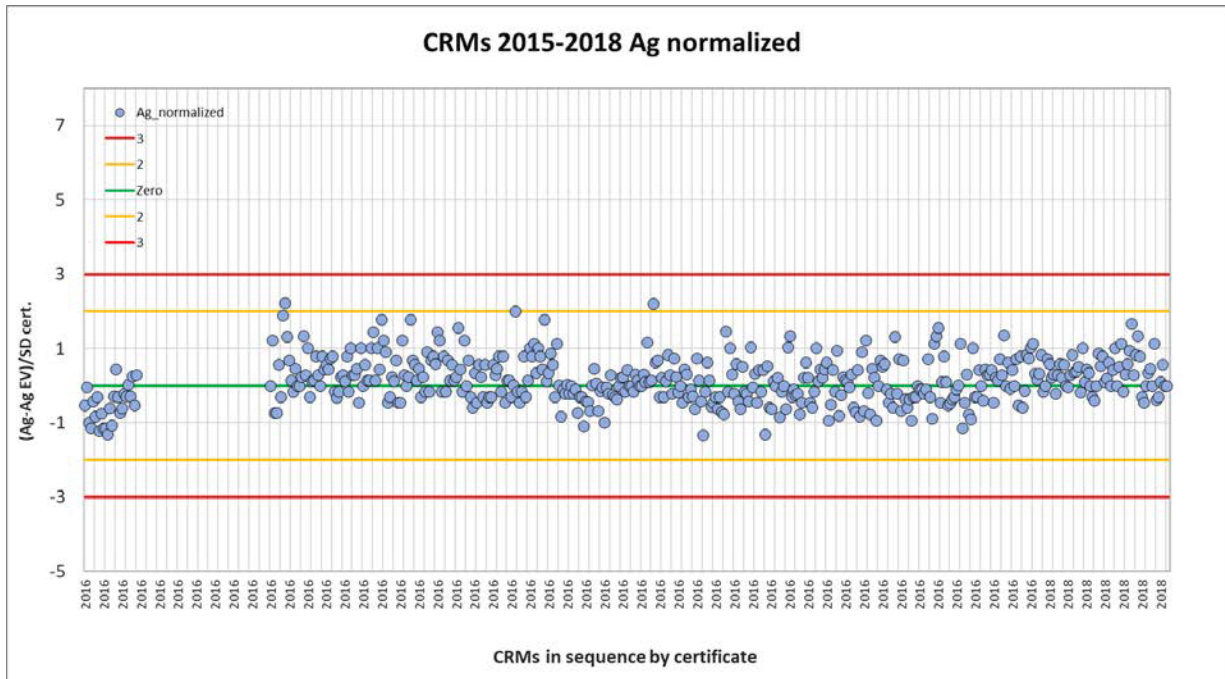
Overall, the standards performance is acceptable, with Cu displaying a stronger variance, exceeding the +2/-2 warning thresholds frequently and most pronounced in the 2018-inserted standards, but without a discernible trend over time or bias to either side. This was confirmed by straight averaging the data and comparing overall expected value vs. assay value (0.474 % Cu to 0.47 % Cu), indicating that the Cu data for the 2015-2018 resampling and re-assaying programs might be slightly conservative.



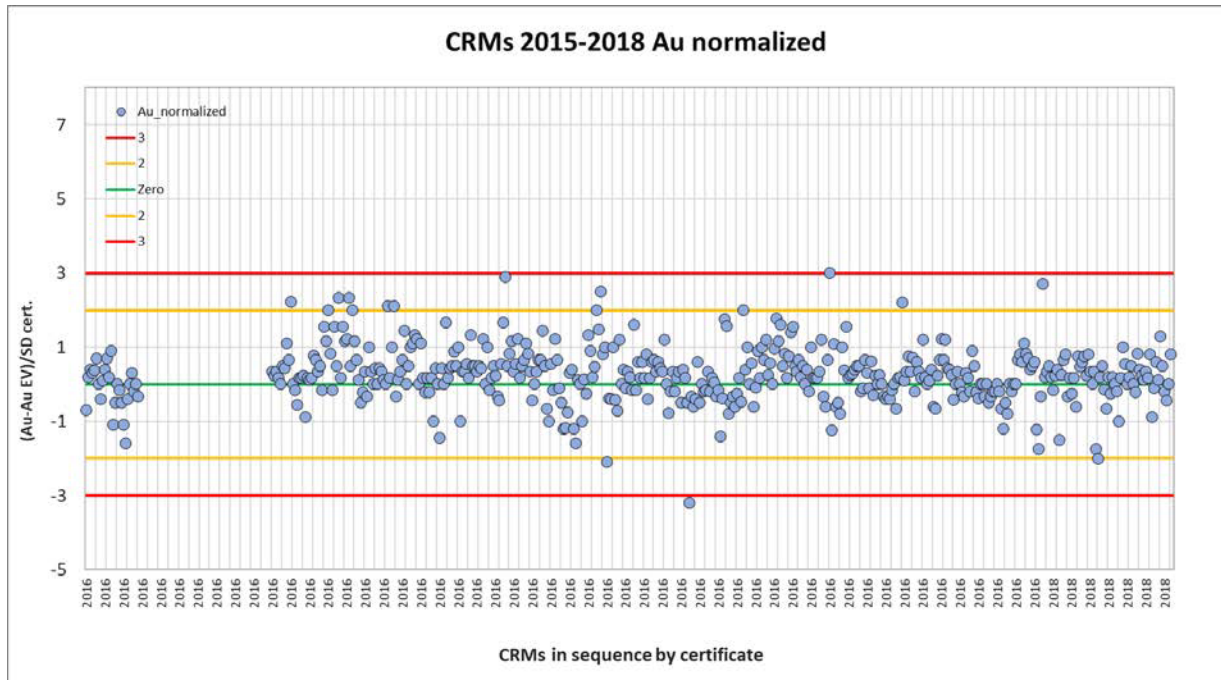
**Figure 11-29: Standard Performance from 2015 - 2018 Program - Cu**



**Figure 11-30: Standard Performance from 2015 - 2018 Program - Mo**



**Figure 11-31: Standard Performance from 2015 - 2018 Program - Ag**



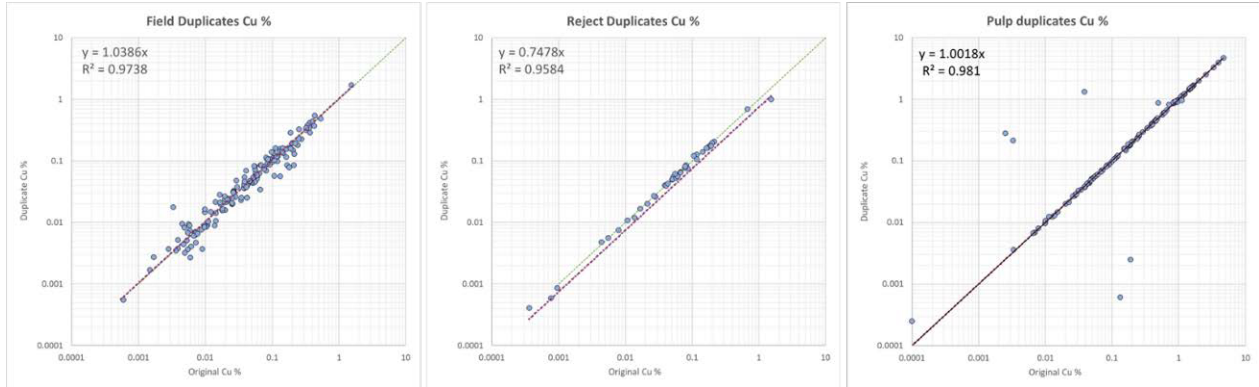
**Figure 11-32: Standard Performance from 2015 - 2018 Program – Au**

### 11.5.3 Duplicate Performance – 2015-2018

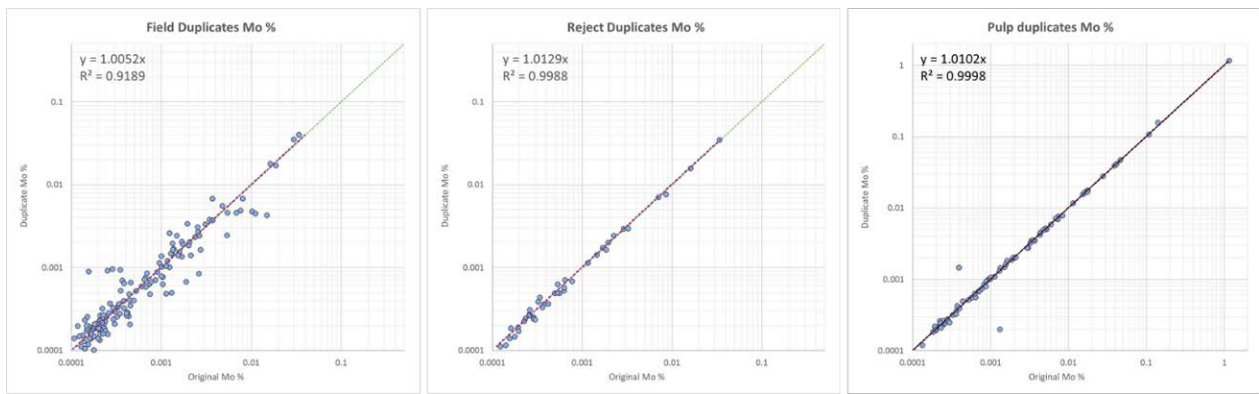
Like the blanks and standards contained in the 2015-2018 programs data, multiple sets of duplicates are present, for example field duplicates of 2011, which were just getting re-analyzed, and new field duplicates taken during resampling of historical core. Overall, they serve the same purpose of precision control, except that the 2011 field and coarse reject duplicates delineate potential preparation error by ACME of 2011, if any, not SGS of 2016-2018.

For the following log scale xy scatter plots for field, coarse reject and pulp duplicates, the duplicate samples created in 2011 have been excluded since they have already been shown to demonstrate acceptable correlations between original and duplicate in chapter 11.3.

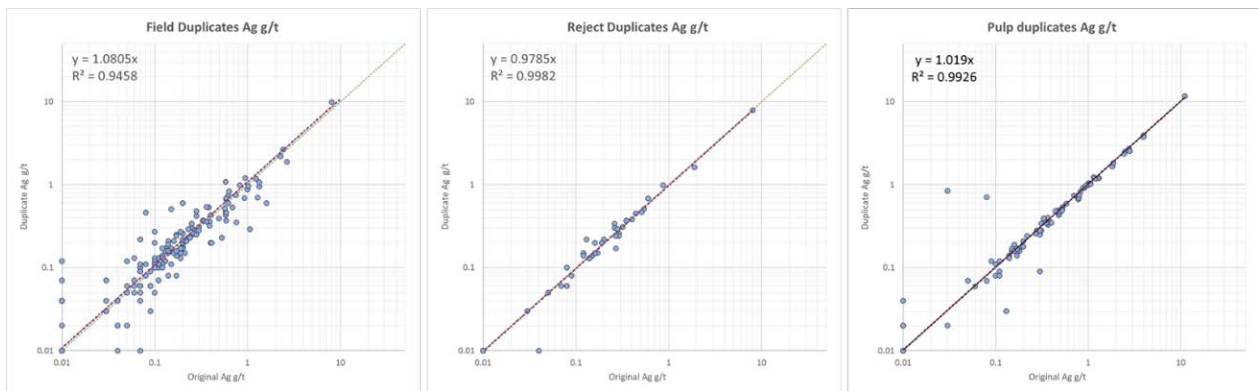
The plots for all 4 metals show significant data correlation increases (represented by  $R^2$ ) with decreasing number of sample size reduction steps at SGS, which is a very good result. A few outliers are shown both in the Ag and Cu pulp duplicate plots that may represent sample mis-classifications. The moderate original-positive trendline in the reject duplicate plot for Cu is caused by a single high-grade sample for which no over-limit Cu grade was requested on the duplicate side of the pair (value was set to 1% which is the upper reporting limit).



**Figure 11-33: Duplicate Performance from 2015 - 2018 Program – Cu**



**Figure 11-34: Duplicate Performance from 2015 - 2018 Program – Mo**



**Figure 11-35: Duplicate Performance from 2015 - 2018 Program – Ag**

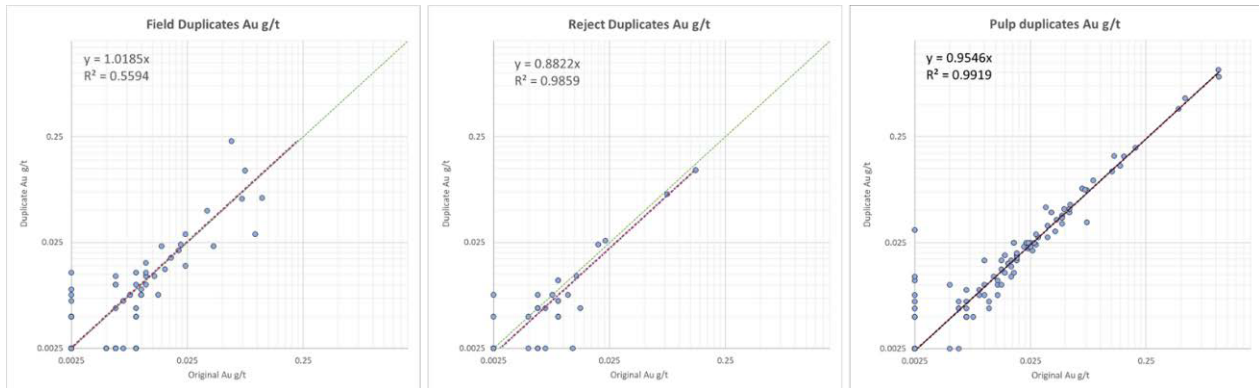


Figure 11-36: Duplicate Performance from 2015 - 2018 Program – Au

MMTS views the duplicate results as acceptable.

### 11.6 Resampling and Check-assays by ALS - 2021-2022

In 2021, Copper Fox resampled additional core from historical drillholes DDH0065, DDH0066, DDH0067, DDH0068, and DDH0078, inserting an appropriate number of blanks and standards but did not collect field duplicates. Figure 11-37 through Figure 11-42 demonstrate acceptable contamination and accuracy performance by ALS. DDH0078 had previously been partially resampled in 2016 and the samples analyzed by SGS.

In 2022, pulps from samples of historical holes DDH0013, DDH-0023, DDH0053 and DDH0125 were re-analyzed (check-assay) by ALS, using a 4-acid digestion. It was found that the analytical results for these samples were based on aqua regia sample digestion method. The comparison between ALS's 4-acid digestion and ICP/MS finishing compared to SGS aqua regia method ICM14B yielded slightly higher metal concentrations at lower concentrations. Intervals of mineralized core were sampled/re-sampled from DDH24, DDH-37, DDH-40, DDH-58 and DDH-59 were sampled/re-sampled to determine copper, molybdenum, gold and silver concentrations.

MMTS was not able to pair all available ALS certificates data to the sample sheet provided by Copper Fox, likely because of re-numbering. This data of approximately 170 samples is therefore currently not included in Table 11-5 or the corresponding plots. However, given the total available data for 599 samples including QAQC, the plots are still considered meaningful.

Table 11-5: QAQC Insertion Rate – 2021 - 2022

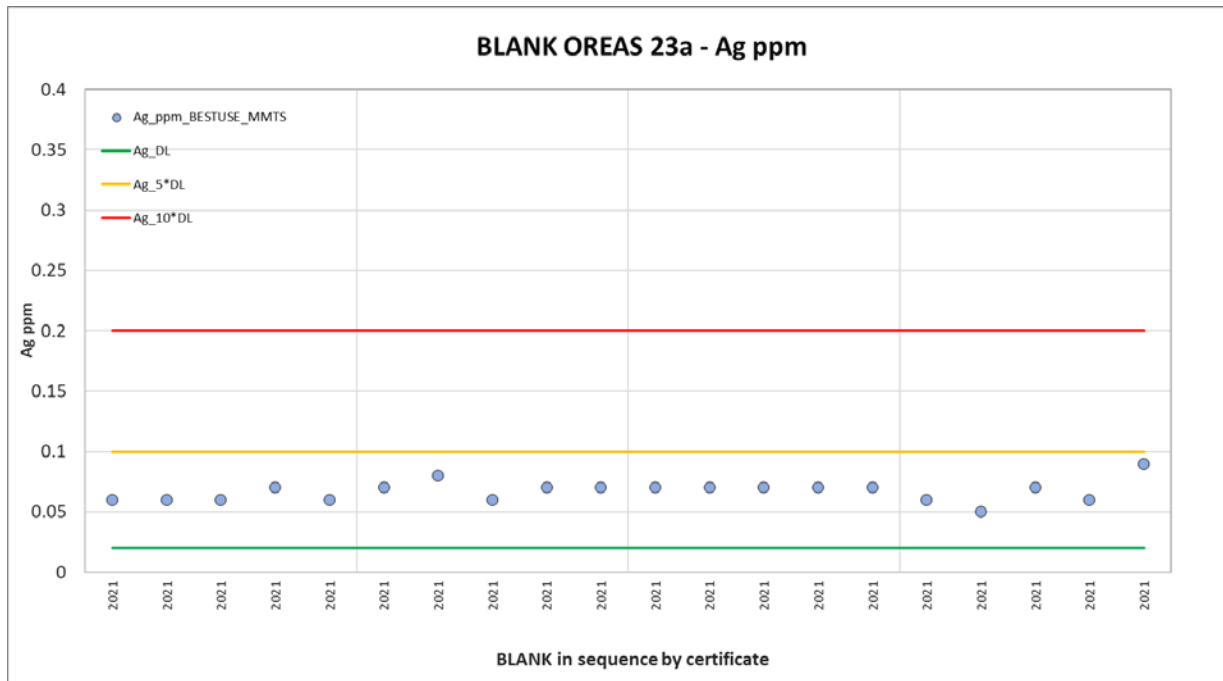
Sample Type	2021		2022		Total	
	Count	%	Count	%	Count	%
DH samples	295	83.3%	205	83.7%	500	83.5%
Blanks	20	5.6%	14	5.7%	34	5.7%
CRMs	39	11.0%	14	5.7%	53	8.8%
Duplicates	0	0.0%	12	4.9%	12	2.0%
Check assay	0	0.0%	0	0.0%	0	0.0%
QC total	59	16.7%	40	16.3%	99	16.5%
<b>Total</b>	<b>354</b>	<b>100.0%</b>	<b>245</b>	<b>100.0%</b>	<b>599</b>	<b>100.0%</b>

The company requested ALS’s ME-MS61 4-acid near total digestion method with ICP/MS finish plus Au-AA23 30g fire assay Au analysis for the 2021 samples, while in 2022 both ME-MS61 and ME-MS61L (93 samples) were used. ALS’s ME-MS61L ultra-trace method offers lower detection limits, for Cu for example the DL decreases from the regular 0.2ppm to 0.02ppm.

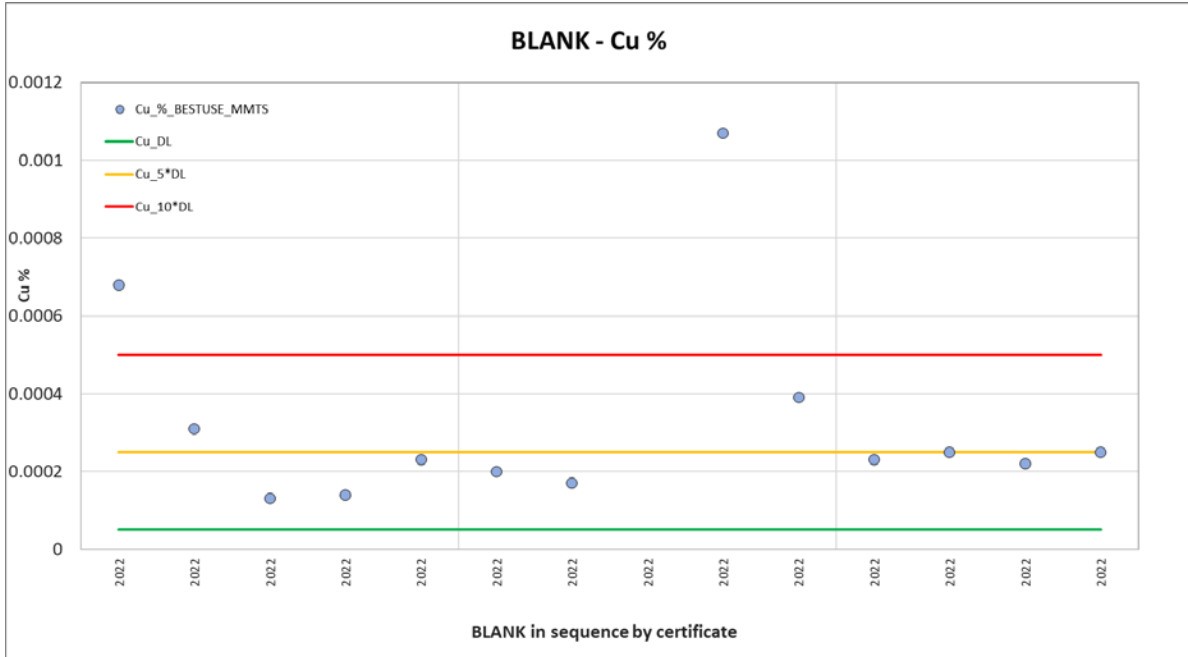
**11.6.1 Blanks Performance – 2021-2022**

As blank material, Copper Fox used OREAS 23a in 2021 and a blank (OREAS – Coarse Silica Blank Material) in 2022. No significant contamination was noted for Ag, Cu, and Mo in either of them. Au could not be reported as the sent blanks did not contain sufficient material for the fire assay procedure.

Figure 11-37 shows a very slightly elevated Ag background in OREAS 23a, while Cu and Mo plot consistently at detection limit (not shown). The 2022 blank (OREAS Coarse Silica Blank Material) does also not indicate substantial contamination, though the Cu plot (Figure 11-38) records one single outlier at 10.7 ppm.



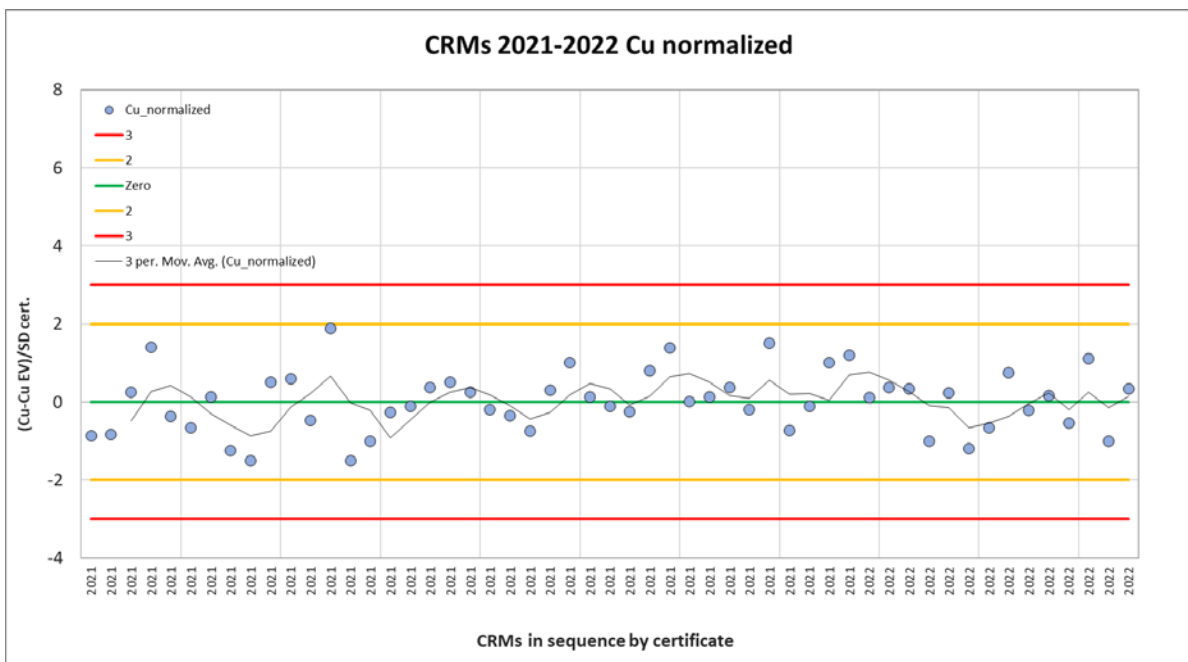
**Figure 11-37: Blank Performance from 2021 - 2022 Program - Ag**



**Figure 11-38: Blank Performance from 2021 - 2022 Program - Cu**

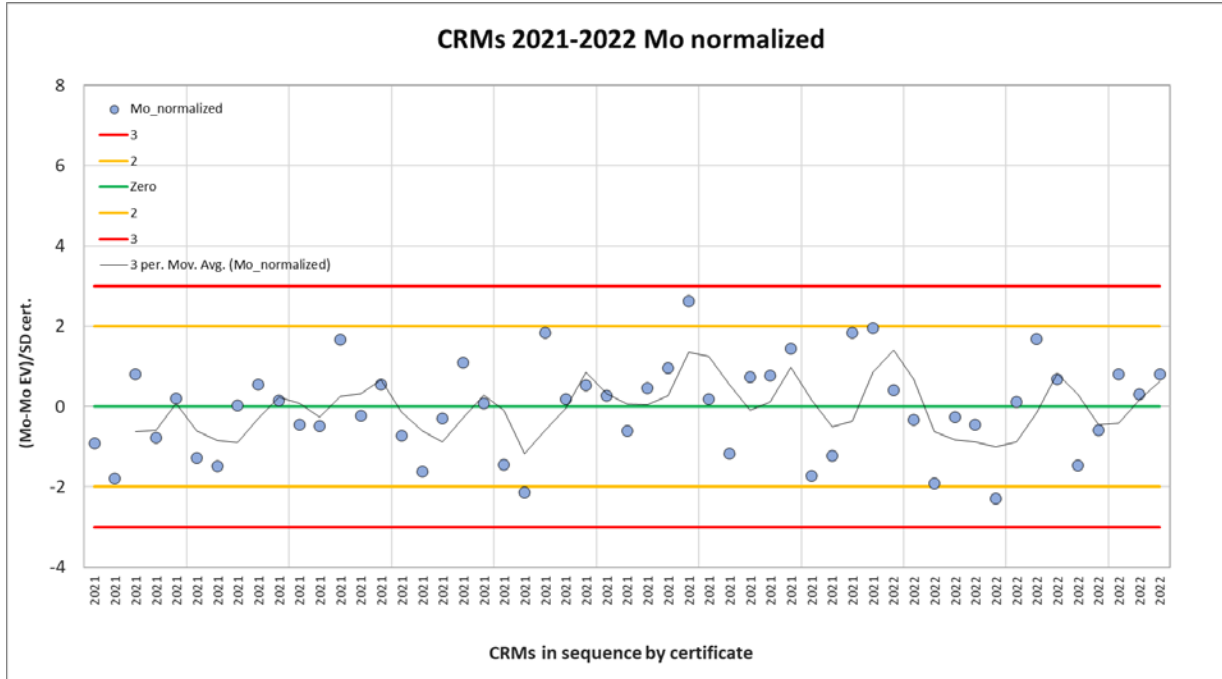
### 11.6.2 Standards Performance – 2021-2022

The Eaglehead CRM data for 2021-2022 shown in the following PCC-style plots has been normalized by using the certified means (expected values) and standard deviations for each respective CRM. Copper Fox utilized 11 different CRMs for the programs, assumingly to maximize coverage of the metal grades at Eaglehead. A few of the CRMs are not certified for 4-acid Ag, which led to a smaller number of data points in Figure 11-41.

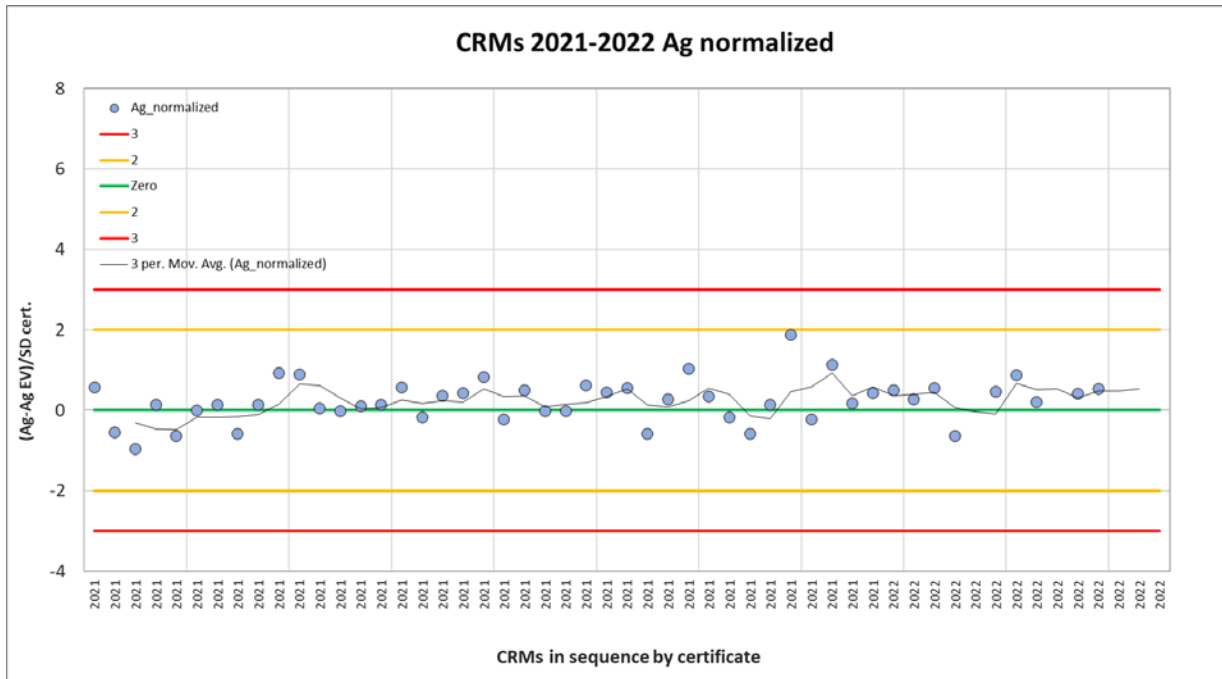


**Figure 11-39: Standard Performance from 2021-2022 Program – Cu**

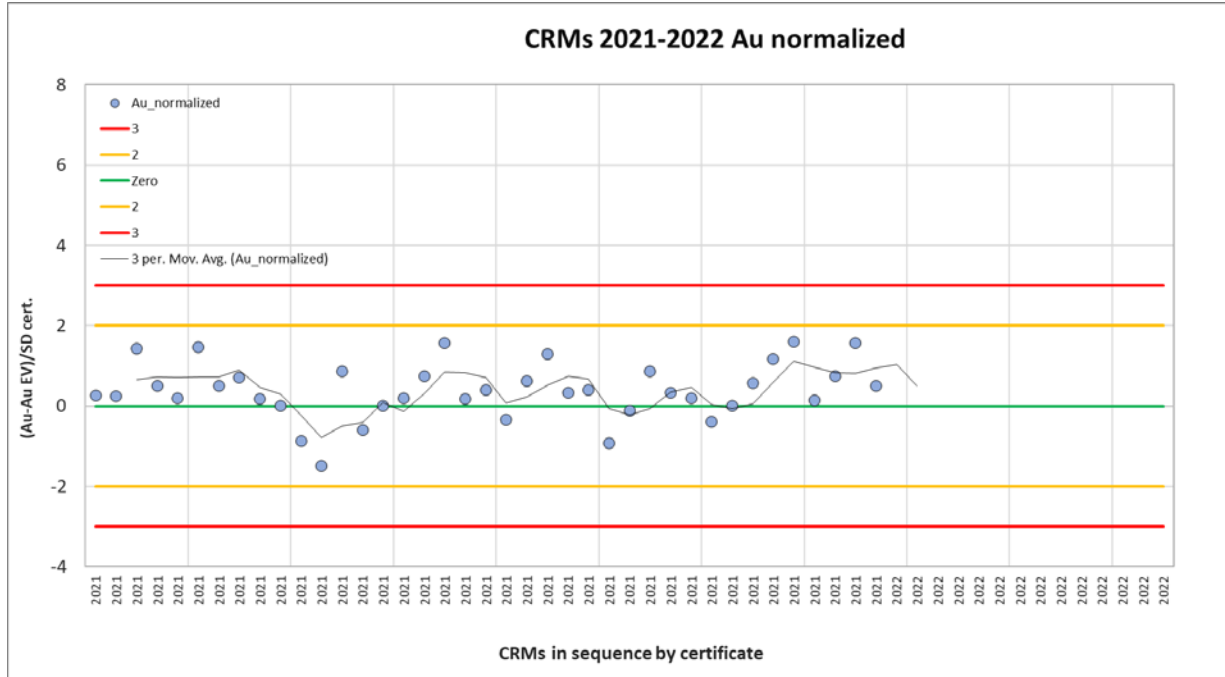




**Figure 11-40: Standard Performance from 2021-2022 Program – Mo**



**Figure 11-41: Standard Performance from 2021-2022 Program – Ag**



**Figure 11-42: Standard Performance from 2021-2022 Program – Au**

### 11.6.3 Duplicate Performance – 2021-2022

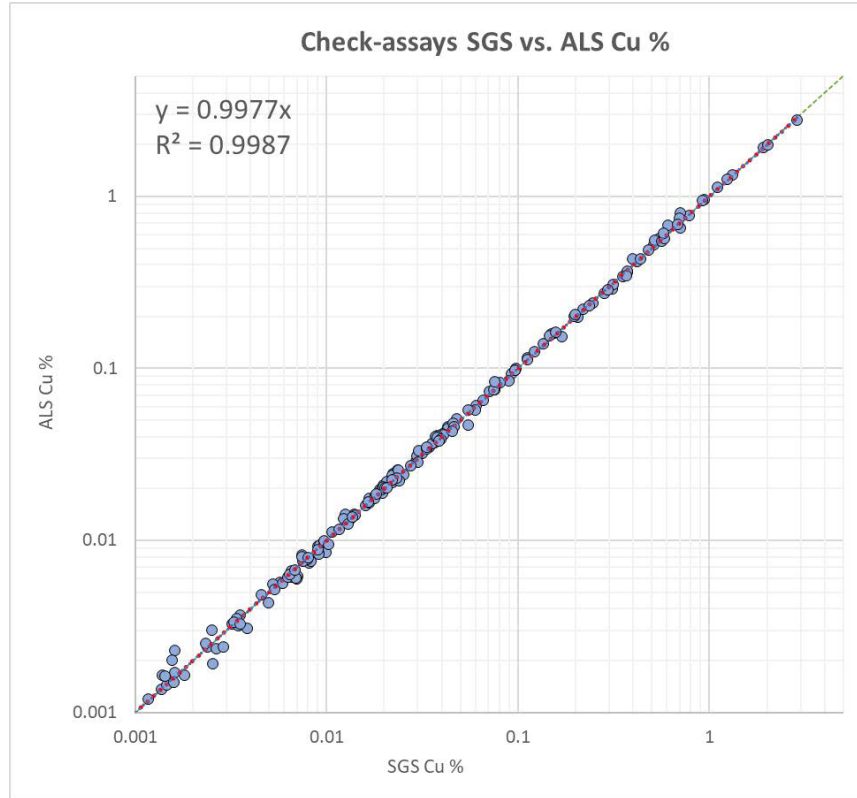
The duplicates shown in Table 11-5 represent field duplicates taken in 2015 when DDH0013 and DDH0053 were resampled, and DDH0125 sampled. As such, they have already been included in the field duplicate plots of Section 11.4.

Overall, MMTS has no concerns about the quality of the ALS data.

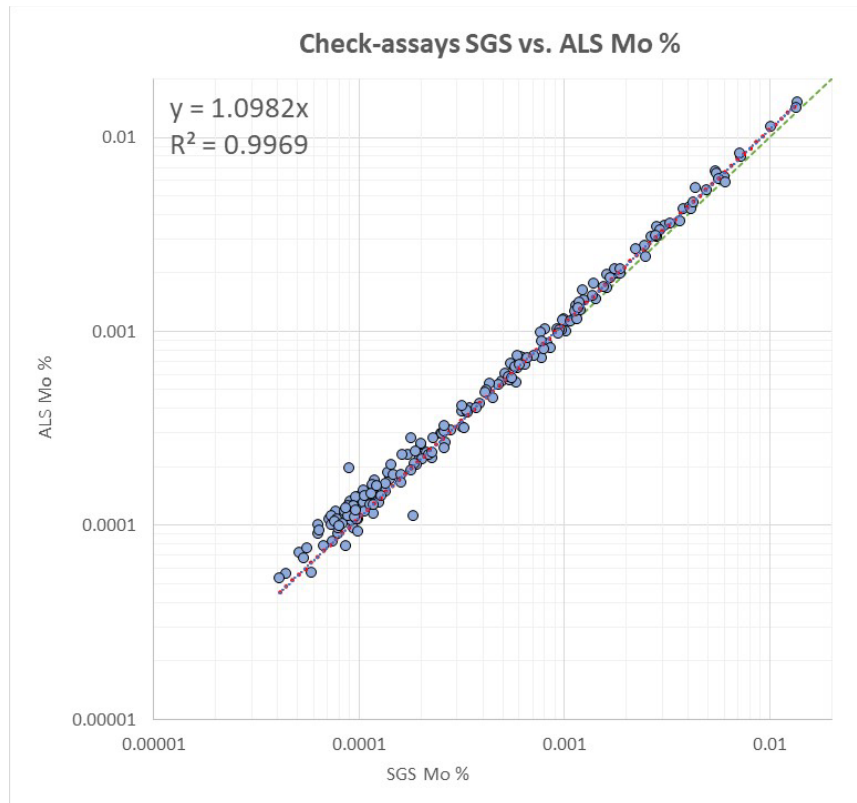
### 11.6.4 Check-assay SGS Aqua Regia vs. ALS 4-acid – 2021-2022

270 pulps from drillholes DDH0013, DDH0023, DDH0053, and DDH0125 were sent to ALS Vancouver in 2022 to get re-analyzed by ME-MS61, no fire assay Au was requested [gold content in the original samples were determine by FA. No need to re-do the FA again] . MMTS reduced the data to 198 primary core samples to achieve the cleanest possible Eaglehead-only dataset and most meaningful correlation.

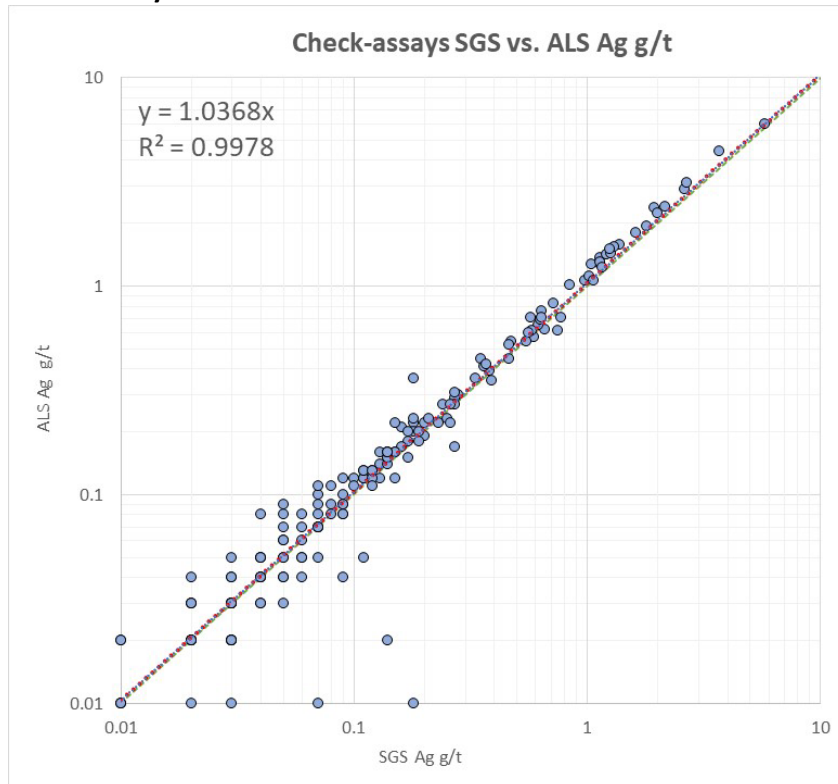
Simple log xy scatter plots with linear trendlines were produced to compare the data on a sample-to-sample basis. Correlations represented by  $R^2$  are close to perfect. Both Ag and Mo indicate a weak to moderate ALS-positive bias across the full range of presented grades. The difference of the mean within this population of 1.2ppm, e.g., 10.7ppm (SGS) to 11.9ppm (ALS), confirms the plot and slope and could be significant if it were to translate into higher-grade sample material as well.



**Figure 11-43: Check Assays – 2021-2022 – Cu**



**Figure 11-44: Check Assays – 2021-2022 – Mo**



**Figure 11-45: Check Assays – 2021-2022 – Ag**

### 11.7 Quality Assurance/Quality Control Procedures – 2017

This section includes a brief review of information prepared by others (McDonough and Rennie, 2012 and Amec Foster Wheeler, 2016) and an analysis of a batch of check assays collected at site on June 7-8, 2017. The previous analyses were found to be adequate and some of the recommendations made by others are included here.

To provide good quality assurance and control of assay data, control samples should comprise at least 12.5% of total samples submitted. The rate for certified reference materials should be at least 5% and include samples of different grades. The insertion rate for blanks, field duplicates and pulp repeats should be 2.5% each. Early drilling at Eaglehead did not include adequate control samples, but this has been corrected in recent years. This control sample insertion rate was verified by Amec Foster Wheeler (2016) and is presented in Table 11-6 below and shows the rate approaching 12%.

**Table 11-6: Quality Control Sample Insertion Rate Summary (after Amec Foster Wheeler, 2016)**

Row Labels	1965-1976	1979	1980	1981	2006	2007	2008	2011	2014	2015	Grand Total
CHECK_PULP									33	58	91
CHECK_REJECT									25		25
COMPANY_BLANK	21	9	3	5	8	33	56	606	90	35	866
COMPANY_STANDARD	20	10	3	5	9	102	164	130	61	35	539
FIELDDEDUP	18	9	4	5	8		2	371	14	34	465
PRIMARY	666	240	420	869	905	1398	1802	7378	1070	578	15326
<b>Grand Total</b>	<b>725</b>	<b>268</b>	<b>430</b>	<b>884</b>	<b>930</b>	<b>1533</b>	<b>2024</b>	<b>8485</b>	<b>1293</b>	<b>740</b>	<b>17312</b>

Row Labels	1965-1976	1979	1980	1981	2006	2007	2008	2011	2014	2015	Grand Total
CHECK_PULP	0%	0%	0%	0%	0%	0%	0%	0%	3%	8%	1%
CHECK_REJECT	0%	0%	0%	0%	0%	0%	0%	0%	2%	0%	0%
COMPANY_BLANK	3%	3%	1%	1%	1%	2%	3%	7%	7%	5%	5%
COMPANY_STANDARD	3%	4%	1%	1%	1%	7%	8%	2%	5%	5%	3%
FIELDDEDUP	2%	3%	1%	1%	1%	0%	0%	4%	1%	5%	3%
PRIMARY	92%	90%	98%	98%	97%	91%	89%	87%	83%	78%	89%
<b>Grand Total</b>	<b>100%</b>	<b>100%</b>	<b>100%</b>	<b>100%</b>	<b>100%</b>	<b>100%</b>	<b>100%</b>	<b>100%</b>	<b>100%</b>	<b>100%</b>	<b>100%</b>

McDonough and Rennie (2012) prepared an NI 43-101 technical report in 2012 showing that assay precision overall was good for Cu, Mo, Ag and Au but that accuracy was poor, with assay values mostly below the lower threshold for standards, indicating that the values in the assay database may be conservative, or there may be a problem with the supplied reference material. They also indicated no significant bias based on field duplicate results.

In 2016, Amec Foster Wheeler performed a site visit, reviewed some of the onsite QAQC data and made recommendations regarding future drilling at site. A review of check assays for Cu showed good correlation.

### 11.8 Adequacy of Sample Preparation, Security and Analytical Procedures

The QP concludes that the sample preparation, security, and analytical procedures utilized in recent exploration programs, from 2006 onward by Eaglehead, meet or exceed current industry best management practices.

Use of a comprehensive QAQC program is recommended to ensure that all analytical data can be confirmed to be reliable. The following is an abbreviated summary of the recommendations by Amec Foster Wheeler (2016), some of which have already been put in place:

- Prepare a detailed, written QAQC procedure that includes assay quality targets, processes to confirm quality targets are achieved, and how to respond when targets are not achieved.
- Assess control sample results on a regular basis, document results of the QAQC program and report results of the control sample program on a monthly basis.
- Complete and document a 5% data entry error check on existing data sets.
- Develop a data import routine in MS Excel to stream-lined importation of analytical results and reduce the level of manual manipulation and eliminate human error; consider developing a relational database in MS Access with automated assay certificate import routines and control sample export routines.

- Restructure the existing MS Excel database to ensure that statistical evaluation can readily proceed by eliminating detection limit indicators and other non-numeric entries.
- Prepare a digital folder structure to allow for archiving and easy retrieval of all original documentation; scan hard copy data, including collar and down hole surveys, drill logs, assay certificates, etc., and store in PDF format.
- Purchase a Standard with a certified Best Value of 0.1% Cu to provide appropriate grade coverage for expected low copper grades.
- Purchase and utilize a Blank which has been demonstrated to be sufficiently devoid of Cu, Mo, Ag, and Au so that grade values are approximately equivalent to assay method detection limits.
- Resubmit 2% of pulp samples assessed by SGS to SGS for re-analysis to provide important laboratory precision information. It is important that SGS pulp assays are matched with SGS pulps and that both have used the same laboratory method. Include Standards and Blanks to monitor laboratory quality.
- Modify the QAQC program to include inserting of 2% coarse rejects and 2% of pulps into future primary batch submissions.
- Select a random 5% of the 2011 pulps and resubmit to SGS. Include Blanks and low, medium, and high-grade Ag Standards at a 2% insertion rate to monitor laboratory quality. After confirming Ag quality, compare the re-assay and new results to confirm no significant bias exists. It is important that SGS pulp results are matched with SGS pulp results and that both have used the same laboratory method.
- Initial assessment of field Duplicates indicates poor precision for Cu, Mo, and Au has been achieved; examine precision of duplicates by year to see if calculated precision improves, and for future drill programs establish careful cutting and sample collection procedures to help limit the impact that field sampling may have on overall precision.
- For any future whole core sampling, prepare a document describing the justification of whole core sampling, prior to whole core sampling collect core photos for all boxes, and add a flag to the database to indicate which intervals are represented by whole core sampling.

## **12 Data Verification**

Sue Bird, M.Sc., P.Eng., visited the Project on August 28, 2022. The helicopter-supported site visit included:

- flying the existing access road eastward from Dease Lake to Boulder City and northward from Boulder City to the Project,
- an aerial perspective of the relative locations of each of the six mineralized zones,
- a brief stop to examine an area of well-exposed bedrock north of the main zones of interest,
- inspections of the camp, core logging and core storage facilities,
- visits to several historic drillhole collar locations for verification, throughout the extent of the deposit, and
- examining and sampling core from all available core.

### **12.1 Assay database Review and Validation 2023**

MMTS undertook an all-assay data review of the drillhole assay database provided by Copper Fox which contained the geochemical data used in the resource modelling efforts described in this report.

Given the size and complexity of the Eaglehead database, highlighted by using multiple laboratories, analytical methods, and overlapping sample data and QA/QC, MMTS proceeded to create its own assay database version based on the provided sample type information and (mostly) original lab data certificates. The result was an independent, near 100% complete QAQC-including dataset from 2011 to 2022, fit for the purpose of direct and mass validation of the existing client database and the subsequently QAQC-free Minesite assay data file.

This MMTS database also served as the source for all QAQC data plots in chapter 11 as well as the quality assurance insertion stats tables from 2011 to 2022.

The validation process confirmed an acceptable match between the new database and the assay data file used for resource modelling. This assay data file contains a total of 17,319 sample intervals, and using Cu as an example, of the 17,319 samples, approx. 14,500 matched perfectly. Subtracting from the remaining population the intervals that could not be assessed because of their historical status or a lack of data in the new database, a group of approx. 1,400 data points remained which were then classified based on the reason they did not match the client database:

1. No match but no concern – for example data with small discrepancies at low grades (likely rounding), samples of which the sample interval was modified so that pairing without unique identifier (sample number) would not work during the evaluation (approximately 700 intervals).
2. No match with possible concern – data where the reason for the discrepancies was inconclusive, where 2011 ACME data was used or when newer (rerun) data appears to exist (approximately 500 intervals).
3. No match and concerning – old data were used when better data was available, data shifts or typos were noticed or where data did not pair because of sample duplication (approximately 150 intervals).

The approximate numbers derived from the validation process are caused by the multitude of reasons that appear to have caused the discrepancies and the inconsistency with which they occur. Often 2 or 3

of the 4 metal assay data points per sample are fully correct while the other 1 or 2 are not. A more in-depth review and focussed follow-up on single outliers or groups of discrepancies should be performed.

For this report, however, MMTS can state that the approx. 150 Cu data that did not fully align between databases and may influence resource modelling represent <1% of the full data set and have likely not materially influenced the estimations.

Verification samples were collected by Bob Lane in 2017 to verify assay results (Lane, 2019) The batch of samples consisted of 12 samples from core stored on the property, 12 drill core pulps sourced from SGS, 4 Standard Reference Material (SRM) and 2 blanks as summarized in Table 12-1. The batch of samples was submitted to MS Analytical (MSA) in Langley BC for analysis. The analytical methods used were Fire Assay with AAS finish for Au, ICP-AES for multi-element testing for all samples to include Cu, Mo and Ag, and 4-acid with ICP-AES for higher grades of Cu. The results of these analyses are presented in Table 12-1.

**Table 12-1: Verification Sample Summary by Zone - 2017**

Zone	Type	Drillhole Number	Number Samples
Bornite	Core	114	2
Bornite	Pulp	76,114,120,122	5
East	Core	59,74,107	7
East	Pulp	60,77,93	5
Pass	Core	48,53	2
Pass	Pulp	20	3
CDN-CM-31	SRM		1
CDN-CM-17	SRM		1
CDN-CGS-16	SRM		1
CDN-CGS-18	SRM		1
CDN-BL-10	Blank		2

The correlation of the original to the re-assays is provided in Figure 12-1 through Figure 12-4 for both core and pulp duplicates where applicable. A best fit line to the data shows both a high coefficient of correlation and a slope close to 1.0 for all metals, indicating that the re-assays show an acceptable match to the database values.



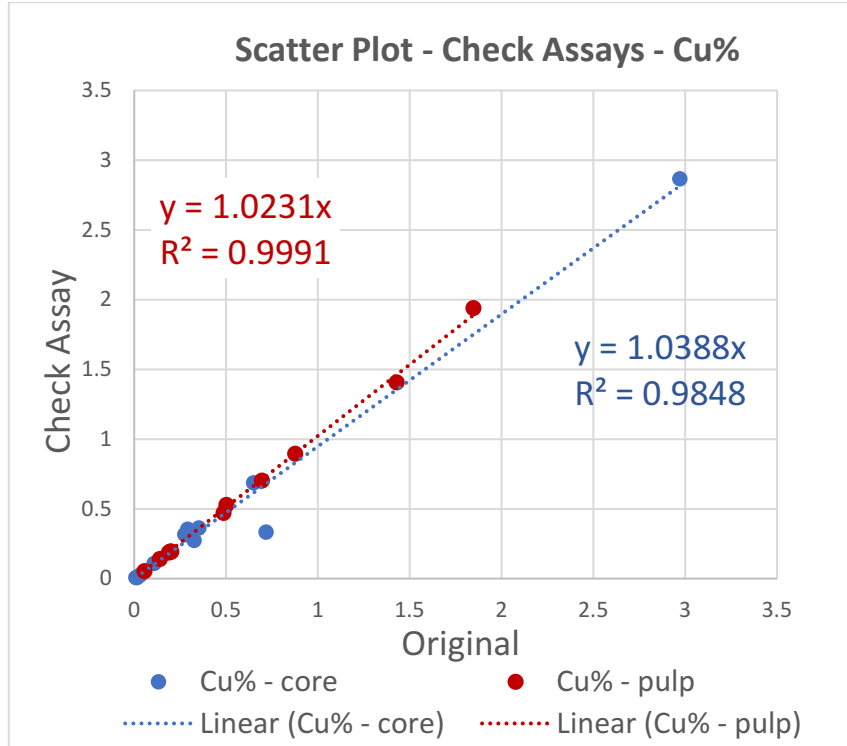


Figure 12-1: Check Assays from 2017 - Cu

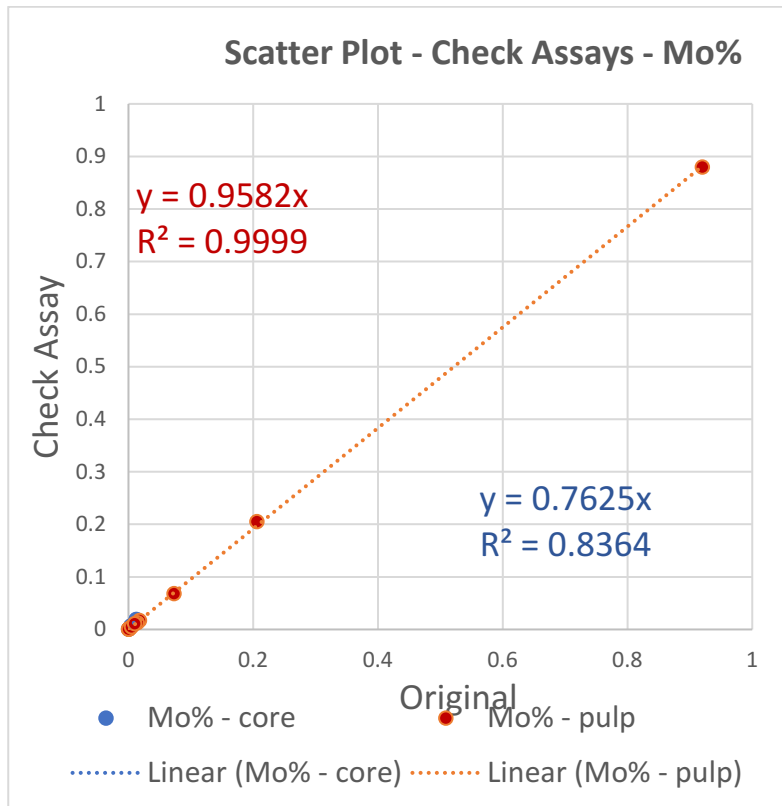


Figure 12-2: Check Assays from 2017 - Mo

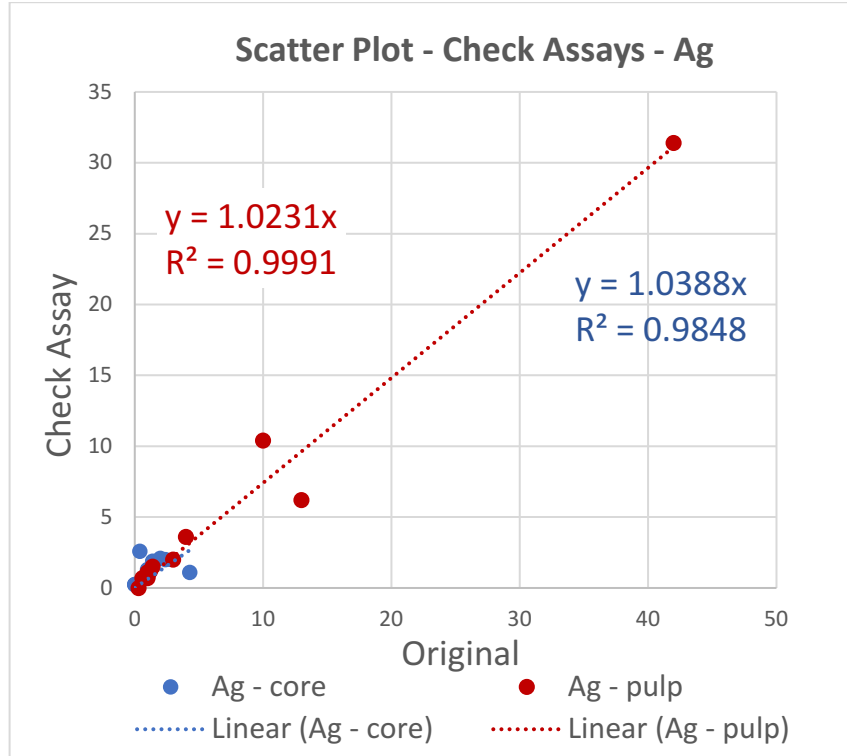


Figure 12-3: Check Assays from 2017 - Ag

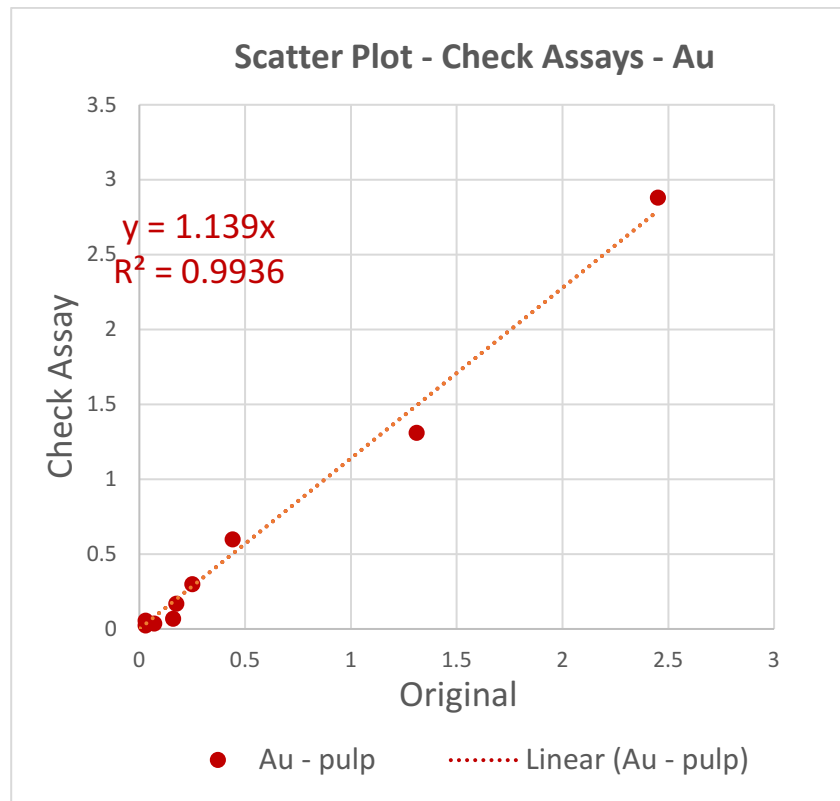


Figure 12-4: Check Assays from 2017 - Au

## **13 Mineral Processing and Metallurgical Testing**

### **13.1 Summary**

In 2014, samples of HQ size core were collected from the Eaglehead Project for preliminary metallurgical testwork to determine the liberation and exposure characteristics and potential metal recoveries of the copper mineralization in the Bornite and East zones. The preliminary metallurgical testwork was performed in 2015 by SGS Canada Inc. (SGS) in their Vancouver facilities (SGS, 2015).

Samples representing three copper grade classes (low grade - 0.11%; medium grade - 0.23%; and high grade - 0.40%) and a master composite (combination of all three grade classes - 0.26% Cu) were subjected to characterization and open circuit flotation testwork. QEMSCAN analysis for mineralogical identification (including modal percentages) was also completed on the samples and sub-samples. The primary copper sulphides were chalcopyrite and bornite. In the master composite, copper sulphide liberation averaged 78% and copper sulphide exposure averaged 91% with very little pyrite (<0.2%) in the composite samples.

Rougher kinetic tests achieved copper recoveries from 92.4% to 97.6% in all tests. Potential copper recoveries to the first cleaner test ranged from 89.8% in the low-grade sample to 95.5% in the high-grade sample and 92.2% recovery in the master composite.

Copper recoveries in the third cleaner concentrate ranged from 77.1% in the low-grade samples to 92.7% in the high-grade sample with corresponding copper concentrate grades of between 21.1% and 37.9%. Other metal recoveries in the third cleaner concentrate ranged from 65-87% for gold, 71-80% for silver, and 17-55% for molybdenum.

SGS also estimated the potential metal content of the third cleaner concentrate to average 11.8 g/t gold, 96 g/t silver and 0.816% molybdenum with low concentrations of arsenic, selenium, and tin. Tests to upgrade molybdenum recovery in a separate molybdenum cleaner circuit were not completed.

SGS recommended, among other activities, that additional testwork on mineralization from the Project should include further optimization of the rougher and cleaner stages to establish an optimal flowsheet.

In 2016, District Copper submitted four flotation samples and fifteen grindability samples to SGS for additional rock characterization and preliminary flotation test work on copper mineralization from the Pass, Bornite and East zones on the Project (SGS, 2016). The test work and grindability samples considered variations in lithology, styles of mineralization and associated alteration.

The four samples collected for flotation purposes were stage-crushed to -10 mesh, homogenized, and split into 2 kg charges. A master composite was prepared from the four samples (Table 13-1). The analyses of head samples used in the test work were:

**Table 13-1: Analysis of Head Samples Used in the Test Works**

Analyte	Sample 1	Sample 2	Sample 3	Sample 4	Master Comp
Cu%	0.31	0.16	0.27	0.19	0.2
Mo%	0.008	0.033	0.05	0.019	0.024
Au g/t	0.1	0.07	0.27	0.24	0.18
Ag g/t	1.3	1	1.6	1.4	1.3
Fe%	1.22	1.03	1.37	205	1.94
S%	0.47	0.55	0.67	0.19	0.27

The contents of other elements in the head samples such as As, Cd and Sb, Pb and Zn were extremely low.

## **13.2 Metallurgical Testing**

### **13.2.1 Bond Ball Mill Grindability Test**

The Bond ball mill grindability test is performed according to the original Bond procedure. The test is performed as a locked cycle with a circulating load equivalent of 250% until it reaches a steady state. The test was performed at 80 mesh of grind (180 µm) on the 9 samples. The Bond Ball Mill Work Indices (BWI) varied from 16.9 to 20.6 kWh/t with an average BWI of 18.6 kWh/t, categorizing the composites as hard and very hard.

### **13.2.2 Bond Abrasion Test**

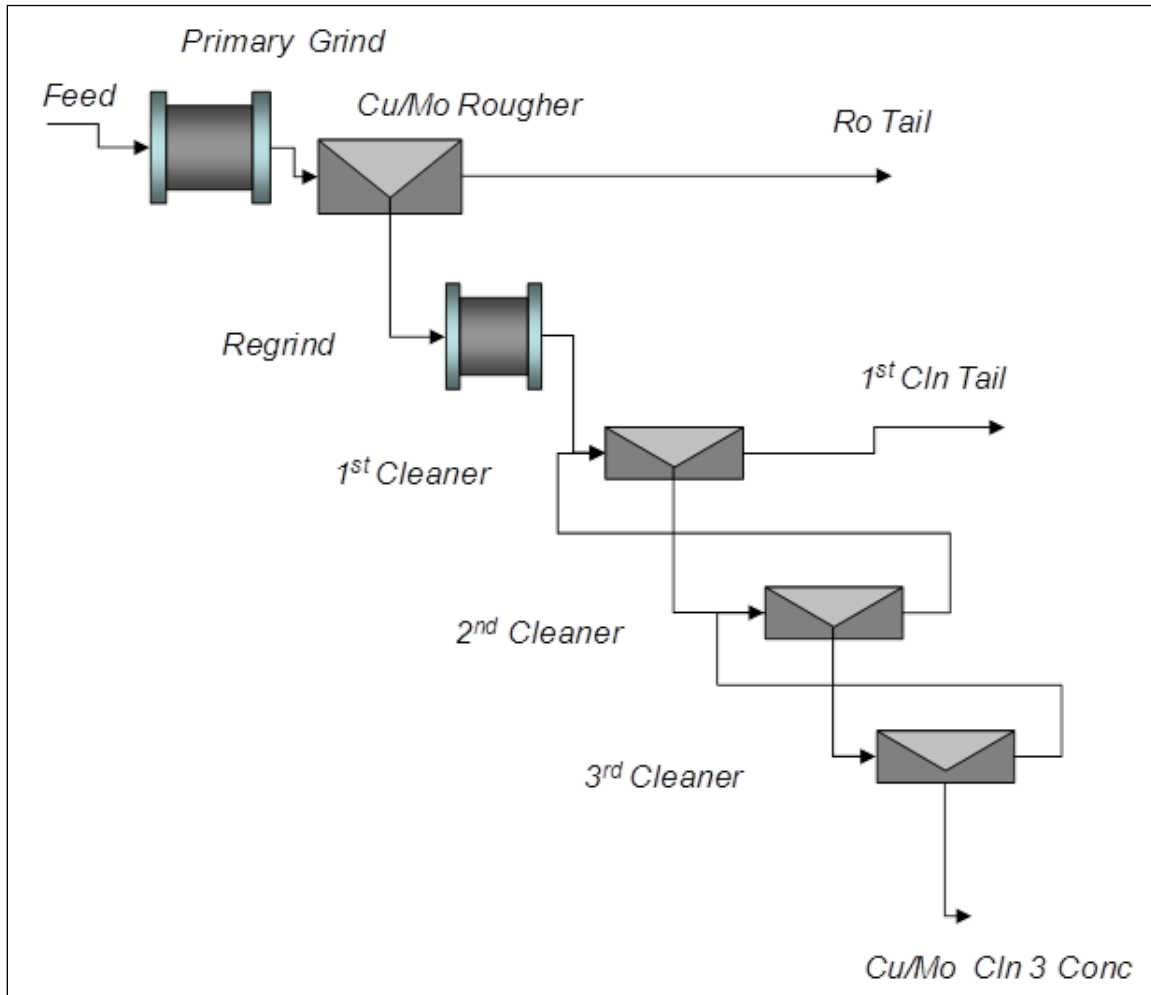
The Bond abrasion test determines the Abrasion Index (Ai), which is used to determine steel media and liner wear in crushers, rod mills and ball mills. The equipment consists of a rotating drum which dried samples are placed with an impact paddle mounted on a centre shaft rotating at a higher speed than the drum. The Ai is determined from the weight loss of the paddle under standard operating conditions. Six composites were selected for the Bond abrasion test. The Bond Abrasion ranged from 0.211g to 0.554g with an average Ai of 0.381g. The samples were categorized as medium to abrasive.

### **13.2.3 Mineralogy**

QEMSCAN (Quantitative Evaluation of Materials by Scanning Electron Microscopy using the Particle Mineralogical Analysis mode (PMA)) analysis of the head samples and a sample of copper-molybdenite concentrate from the locked cycle testing indicated that chalcopyrite is the dominant copper sulphide in all four samples with significant amount of bornite in samples 1, 3 and 4. The analysis also showed pyrite concentrations ranging from 0.03-0.17% with Plagioclase and quartz as the two predominant gangue minerals, ranging from 43.6-48.3% and 22.6-27.8%, respectively.

### **13.2.4 Flotation**

The standard flotation test procedure involved grinding a 2 kg test charge at 65% solids, in a laboratory ball mill to target grind size. After grinding, the density of the pulp was adjusted to 33% solids in a Denver D1 flotation cell. The collectors were then added, conditioned and finally the frother added. Air was introduced to the pulp and concentrates were collected over specified time periods, in stages. Regrinding of the rougher concentrate for cleaner tests was conducted using a ceramic mill. The flotation times were 14 minutes, and four stages of rougher were employed. The flowchart for the various aspects of the test work is shown in the Figure below:



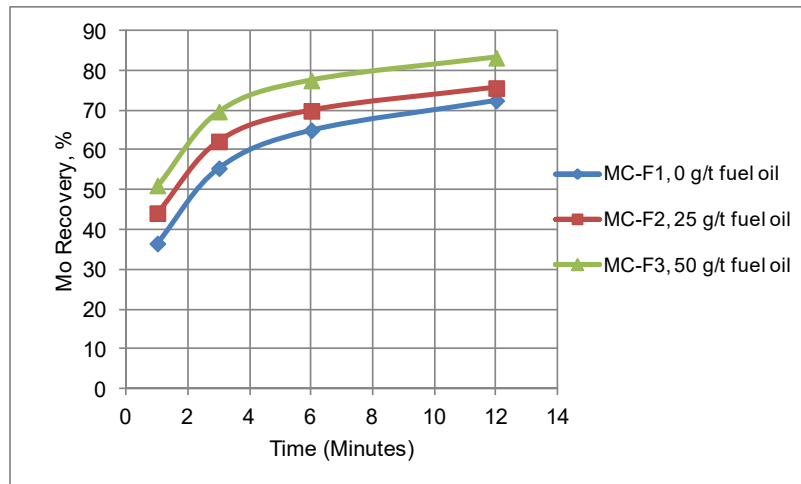
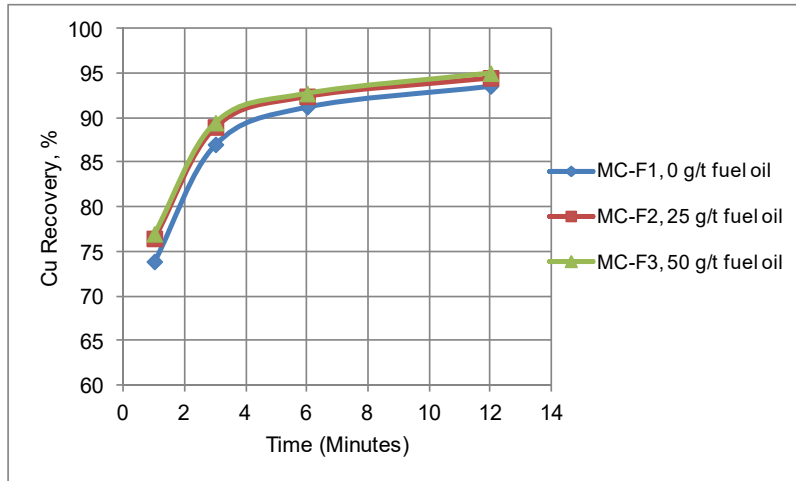
(Source: SGS, 2016)

**Figure 13-1: Test Works Flowchart**

### 13.2.5 Rougher Flotation Testing

Flotation testing (14 minutes and 4 Rougher stages) was conducted on the master composite and four variability samples. A series of 9 batch rougher tests was conducted: 3 on the Master Composite and 6 on the sub-composites. Rougher flotation conditions were employed except with fuel oil addition. The test charge was ground to approximately  $K_{80}$  of 150  $\mu\text{m}$  and the flotation was carried out at natural pH of 8-8.2 with 30 g/t of collector PAX addition.

Three rougher kinetic tests on the Master Composite achieved copper recoveries ranging from 93.6 – 95.2% Cu. The molybdenite recoveries in the rougher concentrates ranged from 72.5-83.2%. The addition of fuel oil improved molybdenite recovery. The time versus percentage recovery curves for copper and molybdenite recovery for the three master composite tests is presented in the Figure below.



(Source: SGS, 2016)

**Figure 13-2: Time versus Percentage Recovery Curves for Copper and Molybdenite**

### 13.2.6 Cleaner Flotation Testing

A series of 11 batch cleaner tests was conducted, 5 on the Master Composite and 6 on the sub-composites. Flotation was conducted following the standard SGS flotation procedure. The test charge was ground to approximately  $K_{80}$  of 20  $\mu\text{m}$  and flotation was carried out at pH of 8.2-11.6 with 6 g/t of collector PAX addition.

The five batch cleaner tests completed on the master composites achieved good copper flotation regardless of the test conditions. The results of the three stages Cleaner Flotation testing on all samples are summarized in the Table below:

**Table 13-2: Results of the Three Stages Cleaner Flotation Testing**

Test No.	Cu/Mo Ro Conc. Mass and grade						Cu/Mo Ro Conc - Distribution %				
	Mass	Cu%	Mo%	Au g/t	Ag g/t	S	Cu%	Mo%	Au g/t	Ag g/t	S
MC-F4	8.08	2.26	0.22	2.10	21.50	2.10	93.40	79.70	86.20	95.00	72.50
MC-F5	8.85	2.09	0.21	1.90	16.30	1.88	93.50	83.90	85.90	91.30	72.30
MC-F6	8.19	2.20	0.23	5.10	14.20	2.14	93.30	80.20	91.90	77.40	73.10
MC-F7	8.13	2.11	0.22	1.90	16.20	1.91	93.50	83.00	89.40	94.70	73.80
MC-F8	8.65	1.98	0.20	1.70	14.50	1.81	94.00	82.60	88.80	83.10	74.00
Mc-LCT1	-	-	-	-	-	-	-	-	-	-	-
Var1-F2	11.60	2.55	0.05	1.00	13.90	2.00	94.90	69.90	87.10	91.00	76.60
Var2-F2	10.59	1.25	0.22	1.00	8.40	1.46	93.70	78.60	79.30	77.40	50.50
Var3-F2	9.84	2.55	0.40	2.40	17.70	2.33	95.90	91.60	92.90	93.30	45.80
Var3-F3	9.22	2.72	0.44	2.00	17.80	2.48	95.80	89.90	87.00	95.80	46.50
Var4-F2	9.65	1.85	0.16	2.20	13.90	1.63	96.60	89.70	88.80	94.90	85.30
Var4-F4	8.28	2.29	0.21	2.90	17.00	1.99	95.40	90.40	89.60	95.00	81.80
Test No.	Cu/Mo Cln Conc. Mass and grade						Cu/Mo Cln Conc - Distribution %				
	Mass	Cu%	Mo%	Au g/t	Ag g/t	S	Cu%	Mo%	Au g/t	Ag g/t	S
MC-F4	0.47	35.00	2.30	33.10	317.00	29.30	83.70	47.50	77.40	81.10	58.50
MC-F5	0.47	35.30	2.56	32.00	256.00	28.40	83.70	53.00	76.90	76.00	57.60
MC-F6	0.42	36.40	2.04	86.60	213.00	30.40	78.90	36.70	80.20	59.10	53.10
MC-F7	0.43	35.10	3.12	32.70	257.00	29.00	82.90	62.60	81.60	79.70	59.70
MC-F8	0.43	35.10	2.61	29.50	239.00	28.90	83.50	53.90	78.50	68.40	59.30
Mc-LCT1	0.58	29.60	2.72	28.20	176.00	26.10	89.90	71.10	78.60	78.10	69.90
Var1-F2	0.73	36.70	0.58	14.20	186.00	27.20	85.80	47.80	75.80	76.80	65.60
Var2-F2	0.38	30.40	3.42	23.20	173.00	29.80	82.30	44.80	68.40	57.70	37.20
Var3-F2	0.65	34.70	4.59	32.60	222.00	30.30	85.40	69.40	83.40	76.50	39.20
Var3-F3	0.66	33.10	4.52	23.20	201.00	28.80	84.10	67.10	73.80	78.00	38.90
Var4-F2	0.46	36.10	2.55	43.10	250.00	29.70	89.80	67.20	81.80	81.40	74.10
Var4-F4	0.50	35.60	2.93	44.60	250.00	29.50	89.70	76.90	84.00	84.50	73.20

### 13.2.7 Locked Cycle Flotation Testing

One 6-cycle locked cycle test was completed on the master composite using the following test conditions (Table 13-3):

- Grind size: primary K<sub>80</sub> of 145 µm and regrind K<sub>80</sub> of 21 µm
- Fuel oil: 75 g/t in primary grind and 10 g/t in regrind
- 4 stages of rougher and 3 stages of cleaner
- 30 g/t of PAX in rougher and 6 g/t in cleaner
- Natural pH in rougher and cleaner

**Table 13-3: Locked Cycle Test Results Yielded the Following Results**

Product	Weight		Assays %, g/t					% Distribution				
	g	%	Cu	Mo	Au	Ag	S	Cu	Mo	Au	Ag	S
<b>Cu/Mo Cln3 Conc</b>	34.5	0.58	29.6	2.72	28.2	175.9	26.1	89.9	71.1	78.6	78.1	69.9
<b>Cu/MO Cini Tail</b>	533.7	8.96	0.11	0.03	0.16	1.6	0.19	5	12.5	6.9	11	7.7
<b>Cu/MO Ro Tail</b>	5389.7	90.5	0.011	0.004	0.03	0.16	0.05	5.1	16.3	14.5	10.9	22.3
<b>Feed</b>	5957.9	100	0.19	0.022	0.21	1.3	0.22	100	100	100	100	100

SGS concluded that “excellent flotation results were achieved from the locked cycle test. The final copper/molybdenite bulk concentrate assayed 29.6% Cu, 2.72% Mo, 28.2 g/t Au and 175.9 g/t Ag at recoveries of 89.9% copper, 71.1% molybdenite, 78.6% gold and 78.1% silver”.

The analytical results of third cleaner concentrates from the lock cycle test and six variability samples show that the concentrations of As, Cd, Sb, Pb and Zn were extremely low.

SGS has recommended that additional future testwork should be completed including:

- Copper-molybdenite separation testing is conducted to estimate the final molybdenite concentrate metallurgy (grade and recovery) in future testwork.
- More variability testwork (grindability and flotation) be conducted to build database for the project.
- Environmental characterization of waste products and waste rock studied for static and kinetic tests (example ABA, humidity cell testing process water characterization).
- A strategy for managing final concentrate and tailings in terms of solid liquid separation should also be formalized by evaluating settling, filtration, and rheology.

The QP has used the recoveries from the locked cycle testing as the basis of economic calculations related to the ‘reasonable prospects of eventual Economic extraction’ The master composite head grades are reasonably like average grade of the modeled resource, and deleterious elements have low concentrations in the flotation products.



## 14 Mineral Resource Estimate

The Resource Estimate for the Eaglehead project, is summarized in the Table below. The effective date of the Resource Estimate is August 21, 2023. Parameters used to define the “reasonable prospects of eventual economic extraction” pit are summarized in the Notes to the Table.

**Table 14-1: 2023 Mineral Resource Estimate, Eaglehead Project**

Class	NSR Cutoff (CDN\$ /tonne)	Tonnage (kt)	In situ Grade						In situ Metal					
			NSR (CDN\$ /tonne)	CuEqv %	Cu %	Mo %	Au gpt	Ag gpt	NSR M\$	CuEqv Mlbs	Cu Mlbs	Mo Mlbs	Au koz	Ag koz
Indicated	5	71,971	24.422	0.322	0.219	0.0107	0.060	0.9	1,758	510	347	17.0	139.8	2,159
	5.5	70,810	24.737	0.326	0.221	0.0108	0.061	0.9	1,752	509	345	16.9	139.6	2,151
	8	64,395	26.524	0.349	0.236	0.0118	0.066	1.0	1,708	496	335	16.8	137.5	2,093
	10	58,210	28.383	0.374	0.251	0.0128	0.072	1.1	1,652	480	322	16.4	134.6	2,021
	15	43,415	33.832	0.446	0.293	0.0161	0.089	1.3	1,469	427	280	15.4	123.8	1,798
	20	30,454	40.823	0.538	0.344	0.0207	0.112	1.6	1,243	361	231	13.9	109.2	1,530
Inferred	5	250,820	18.188	0.240	0.187	0.0035	0.042	0.6	4,562	1,325	1,036	19.4	339.5	5,024
	5.5	242,331	18.641	0.246	0.192	0.0035	0.043	0.6	4,517	1,312	1,025	18.7	335.8	4,971
	8	202,996	20.95	0.276	0.215	0.0040	0.049	0.7	4,253	1,235	964	17.9	318.5	4,660
	10	175,071	22.861	0.301	0.234	0.0044	0.054	0.8	4,002	1,163	905	17.0	302.8	4,379
	15	118,277	27.907	0.368	0.283	0.0056	0.068	0.9	3,301	959	739	14.6	260.1	3,590
	20	78,227	33.32	0.439	0.334	0.0069	0.086	1.1	2,607	757	576	11.9	215.5	2,814

### Notes to the Resource Table:

- The Mineral Resource Estimate has been prepared by Sue Bird, P.Eng., an independent Qualified Person.
- Resources are reported using the 2014 CIM Definition Standards and were estimated in accordance with the CIM 2019 Best Practices Guidelines.
- Mineral Resources that are not Mineral Reserves do not have demonstrated economic viability.
- The Mineral Resource has been confined by a “reasonable prospects of eventual economic extraction” pit using the following assumptions:
  - Cu price of US\$3.50/lb, Mo price of US\$20.00/lb, Au price of US\$1,750/oz, Ag price of US\$20/oz at an exchange rate of 0.77 US\$ per C\$.
  - 97% for Cu and Au, 90.0% payable for Ag, 99.0% payable for Mo, 1% Unit deduction for Cu and Mo, Cu concentrate smelting of US\$120/wmt, US\$0.10/lb Cu refining and transport of US\$100/t. For Mo smelting costs of US\$2.5/wmt con, US\$1.52/lb Mo refining, and US\$154.05/wmt transport, Au refining of US\$8.00/oz with Ag refining of US\$0.50/oz with transportation costs included in the Cu con.
  - Recoveries for Cu, Mo, Au, and Ag of 89.9%, 71.1%, 78.6% and 78.1% respectively.
- Resulting NSR equation is:  $NSR = 22.0462 * (Cu\% * CDN\$3.83/lb * 89.9\% + Mo\% * CDN\$23.58 * 71.1\%) + Augpt * CDN\$70.55/g * 78.6\% + Aggpt * CDN\$ 0.74/g * 78.1\%$
- $CuEq = Cu\% + Mo\% * 4.870 + Augpt * 0.7308 + Aggpt * 0.0076$
- Mining costs of C\$1.50/t.
- Processing, G&A, and tailings management costs of C\$5.50/t.
- Pit slopes of 50 degrees.
- Numbers may not sum due to rounding.

The following factors, among others, could affect the Mineral Resource estimate: commodity price and exchange rate assumptions; pit slope angles; assumptions used in generating the LG pit shell, including metal recoveries, and mining and process cost assumptions. The QP is not aware of any environmental,

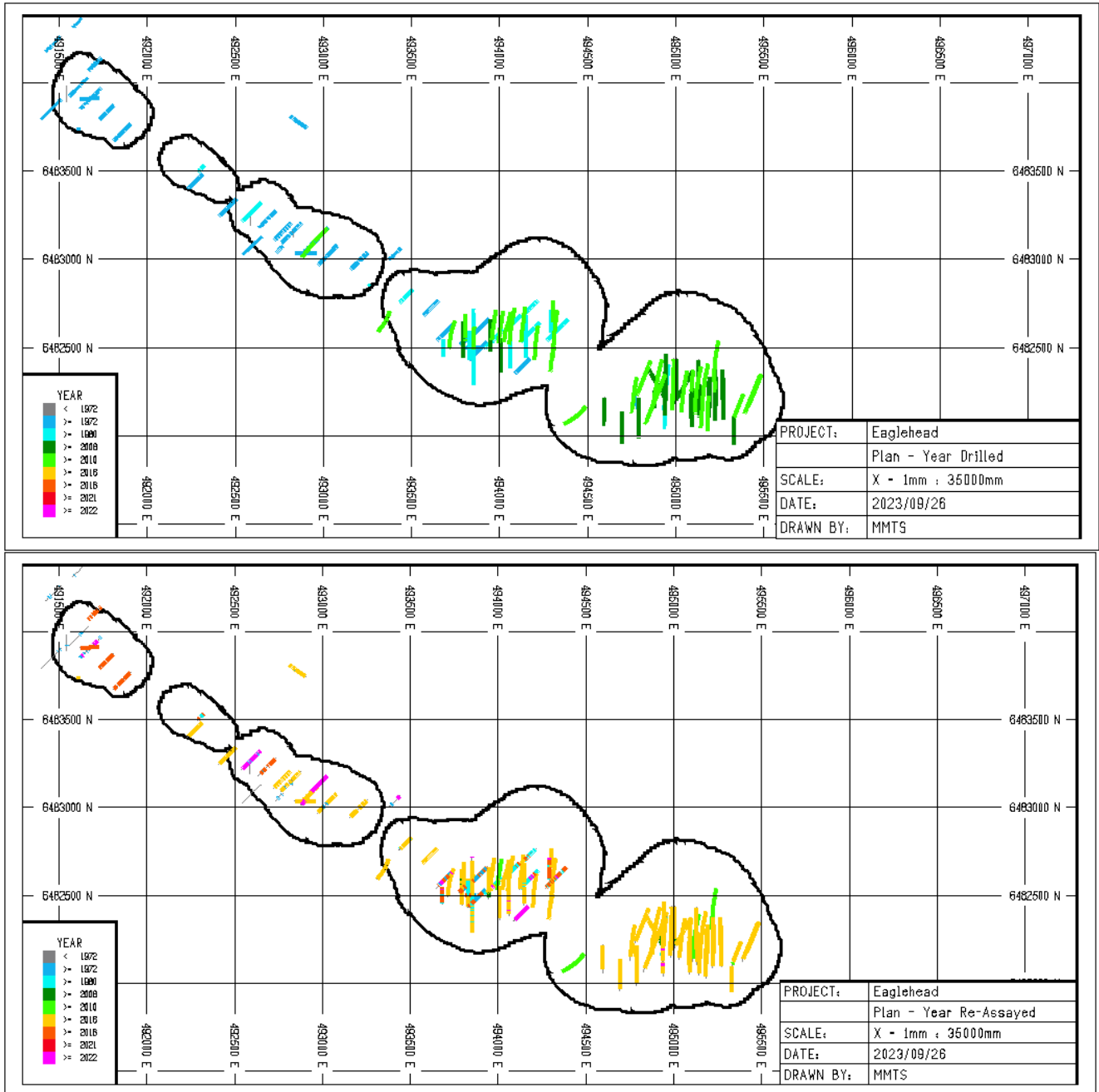
permitting, legal, title, taxation, socioeconomic, marketing, political, or other relevant factors that could materially affect the Mineral Resource estimate.

#### 14.1 Key Assumptions and Data used in the Resource Estimate

The drillholes used for the resource estimate of the Eaglehead deposit are summarized in the Table below. Figure 14-1 is a plan map of all drillholes by year drilled and year re-assayed. Re-assaying of historic holes has been done primarily from 2016 through 2022. As summarized in the table, 84% of the length drilled has an original assay for at least Cu, and 91% of these assays have been re-assayed.

**Table 14-2: Summary of Drillholes and Assays used in the Eaglehead Resource Estimate**

Year Drilled	# DHs	Total Length (m)	Length Assayed (m)	Length Re-assayed (m)	% Assayed	% Re-assayed
1965	4	450	121	121	27%	100%
1972	6	1,184	175	175	15%	100%
1973	21	3,873	3,236	2,827	84%	87%
1976	3	553	352	292	64%	83%
1979	5	877	541	408	62%	76%
1980	9	1,639	1,193	517	73%	43%
1981	11	3,668	2,866	1,864	78%	65%
2006	10	3,050	2,578	2,564	85%	99%
2007	12	4,101	3,589	3,277	88%	91%
2008	14	5,495	5,074	5,058	92%	100%
2011	25	8,302	7,817	7,802	94%	100%
2014	4	2,229	2,133	2,133	96%	100%
2015	2	1,184	1,151	1,143	97%	99%
<b>Total</b>	<b>126</b>	<b>36,606</b>	<b>30,827</b>	<b>28,181</b>	<b>84%</b>	<b>91%</b>

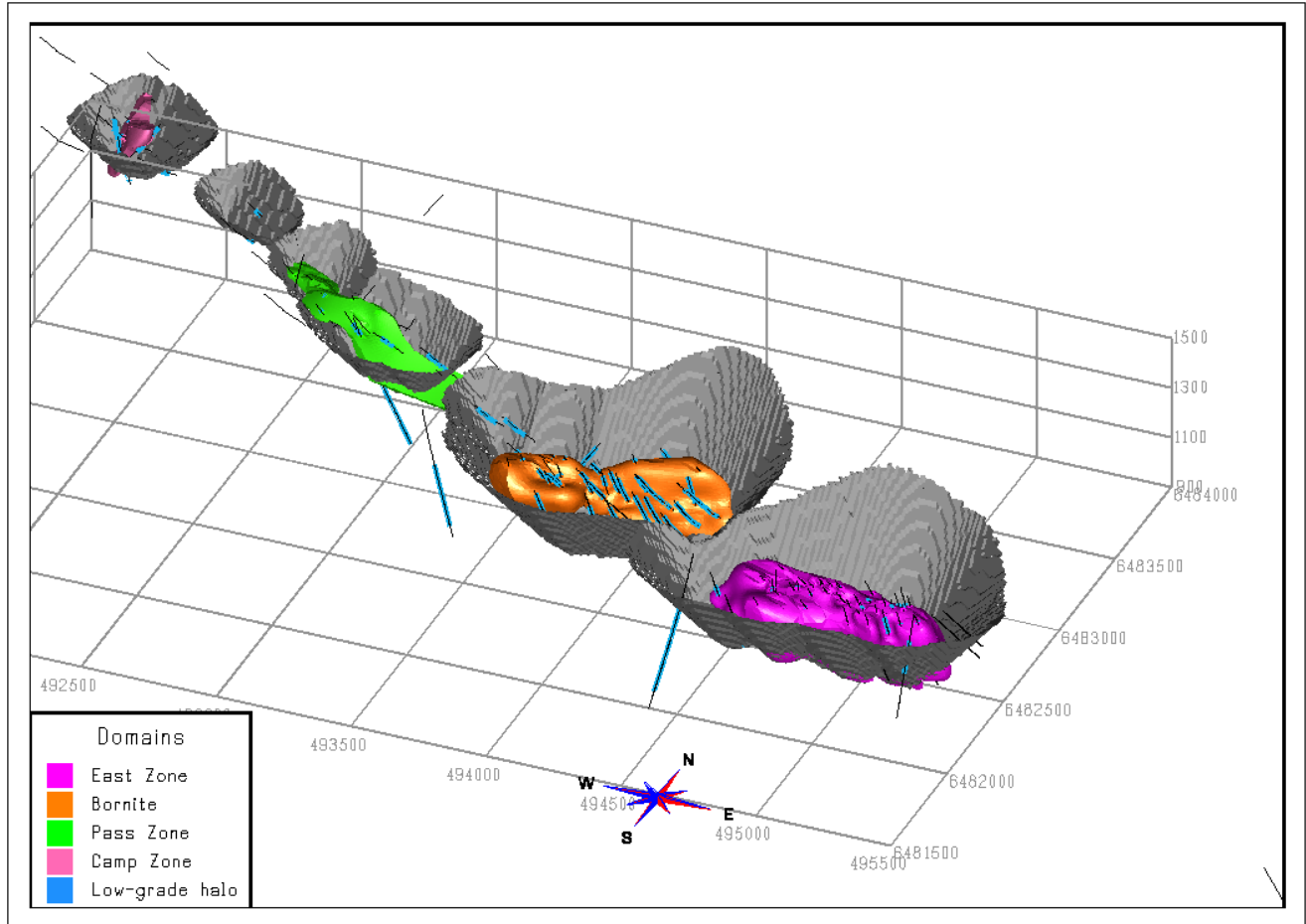


**Figure 14-1: Plan view of Drillholes by Year Drilled (top) and by Year Re-Assayed (bottom) with Outline of the Resource Pit**

## 14.2 Geologic Modelling

The 2022-2023 geologic modelling as described in Section 7 of this report has been used to inform the interpolation domain modelling. For interpolations, 4 main domains have been created using an NSR cutoff of approximately CDN\$15.00/tonne with an additional halo of lower grade mineralization surrounding the higher-grade domains created at a cutoff of approximately 0.10% CuEq. The modelled domains correspond to (from east to west) the East Zone, the Bornite Zone, the Pass Zone and Camp Zone of the Eaglehead project. The figure below illustrates the 4 main domains with the resource pit also

shown. Assays, composites, and blocks were coded with the domains and domain matching for modelling of the domains is required. The block model is a multiple ore percent model with up to two domains per block so that blocks along the boundary between the high and low grade domains are a weighted average of the percent of the block within each domain.



(Source: MMTS, 2023)

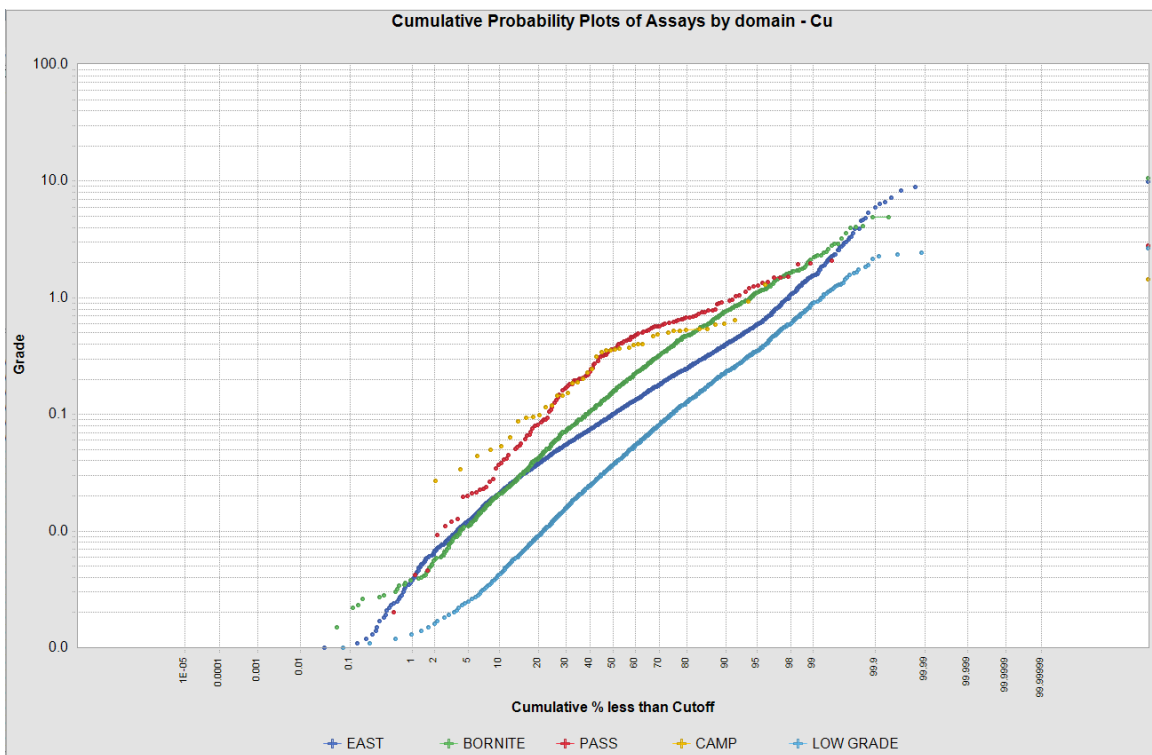
**Figure 14-2: Modelled Domains and Resource Pit**

### 14.3 Capping and Assay / Composite Statistics

Capping of the assays and “Outlier Restriction” of the composites during modelling have both been done to restrict the influence of high grades to ensure that the modelled metal content is not bias compared to the data. The high-grade restrictions also have the effect of reducing the Coefficient of Variation (C.V.) to ensure linear interpolations are appropriate for the data. A summary of capping and outlier restriction is provided in the table below. Cumulative Probability Plots (CPPs) have been used to help determine the capping values. Plots of Cu, Mo, Au, and Ag respectively, by domain, are provided in the Figure 14-3 through Figure 14-6 below.

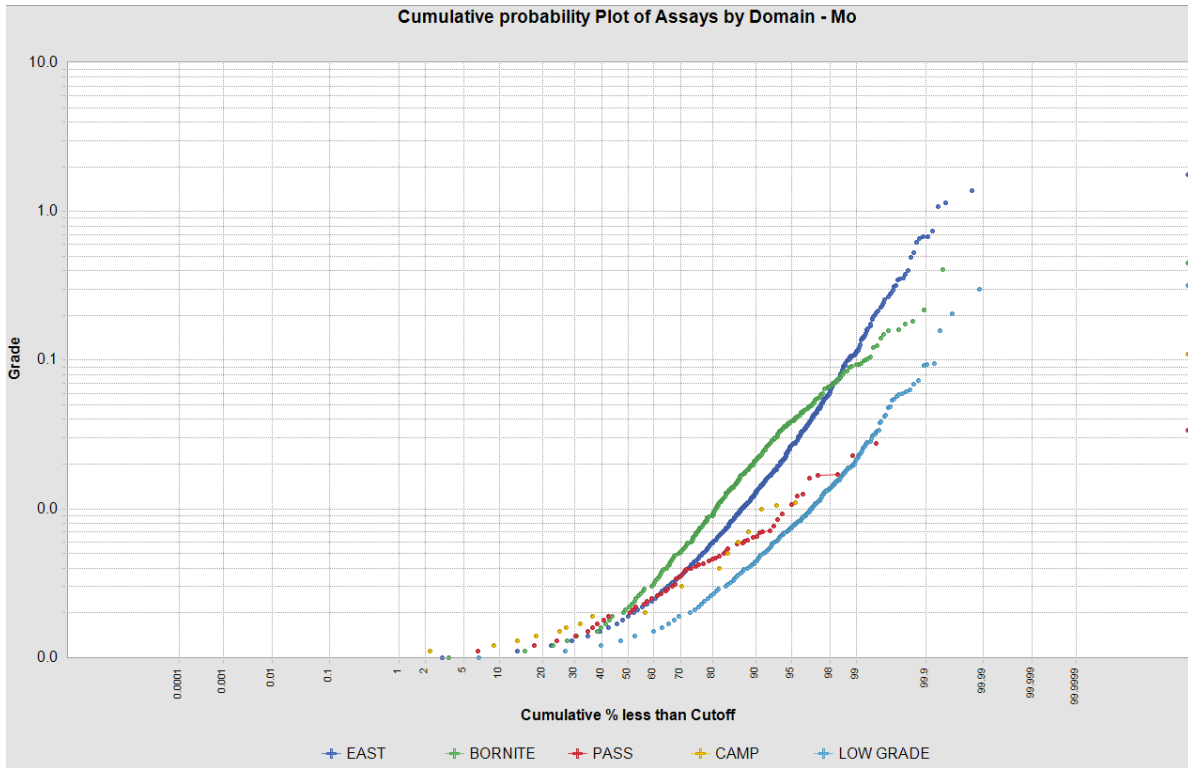
**Table 14-3: Capping and Outlier Restriction by Domain**

Metal	Parameter	Domain				
		East	Bornite	Pass	Camp	Low Grade
Cu	Cap (%)	999	10	2	0.7	999
	Outlier (%)	2.5	1.4	1.0	0.6	1.2
Mo	Cap (%)	1	0.3	0.03	0.01	0.1
	Outlier (%)	---	---	---	---	---
Au	Cap (gpt)	10	8	0.2	0.1	2
	Outlier (gpt)	5	2	0.1	0.1	0.5
Ag	Cap (gpt)	50	50	10	4	10
	Outlier (gpt)	15	15	2	3	6



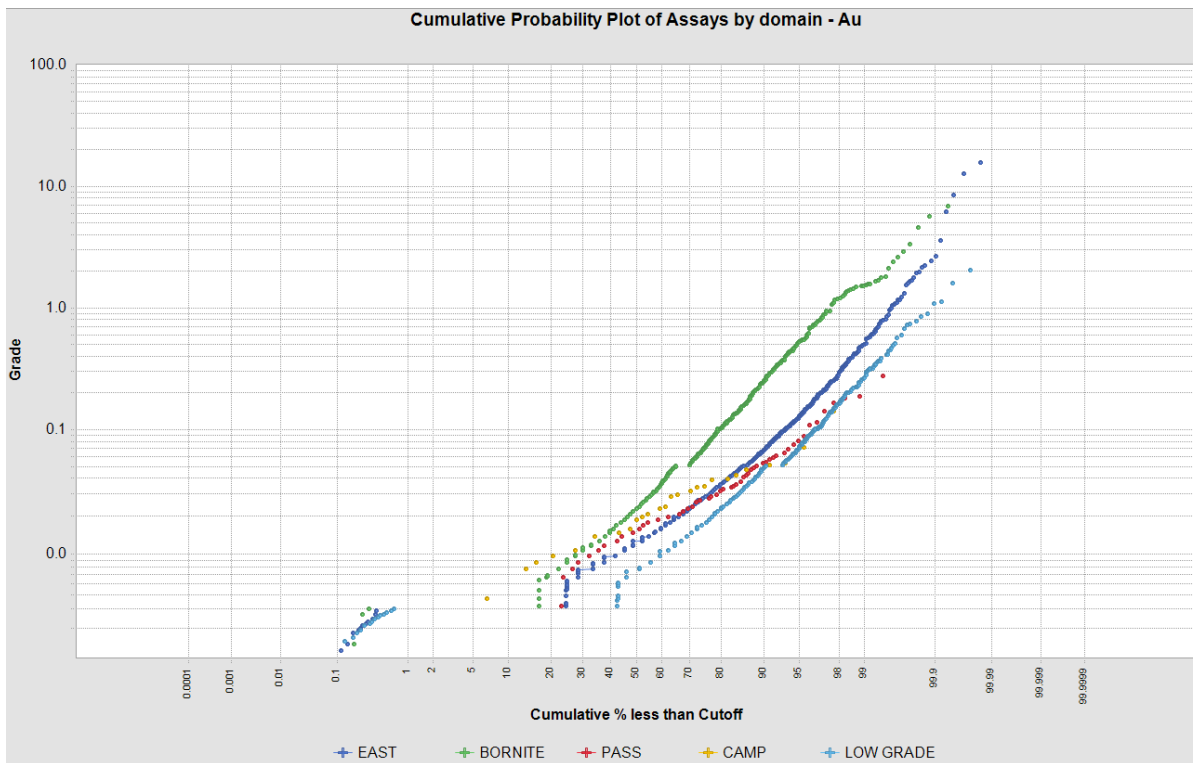
(Source: MMTS, 2023)

**Figure 14-3: Cumulative Probability Plot of Assays - Cu**



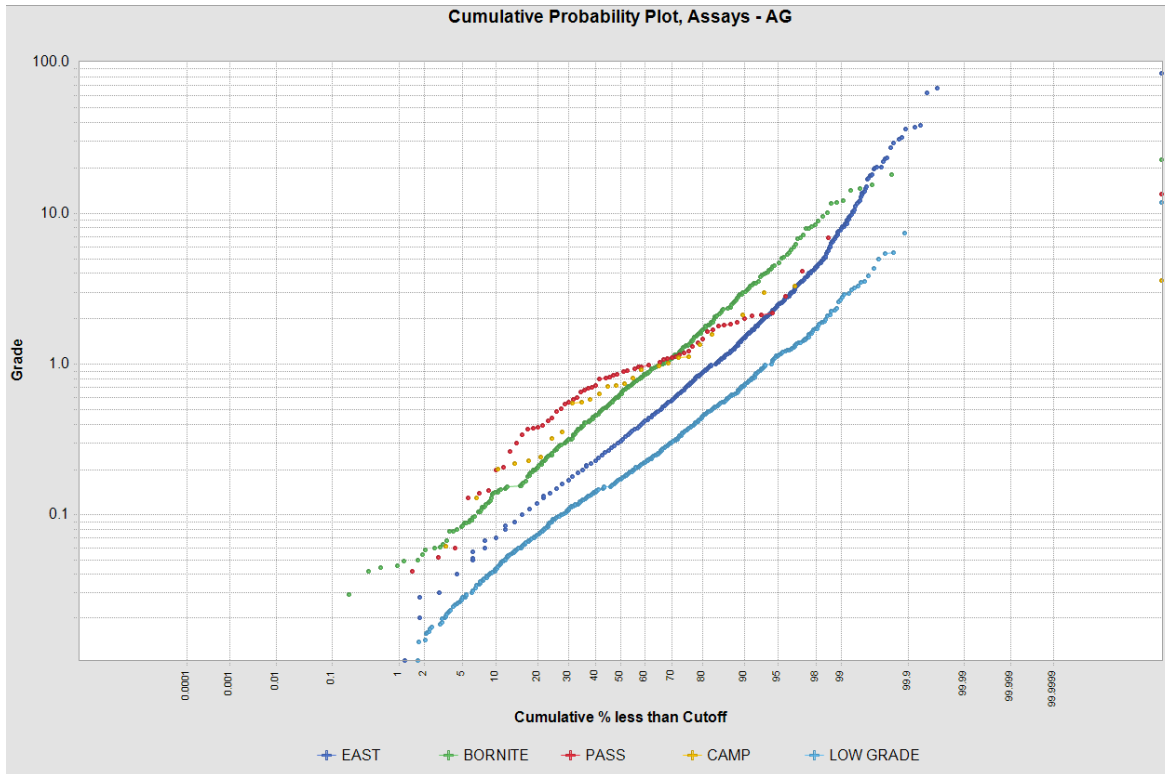
(Source: MMTS, 2023)

**Figure 14-4: Cumulative Probability Plot of Assays – Mo**



(Source: MMTS, 2023)

**Figure 14-5: Cumulative Probability Plot of Assays - Au**



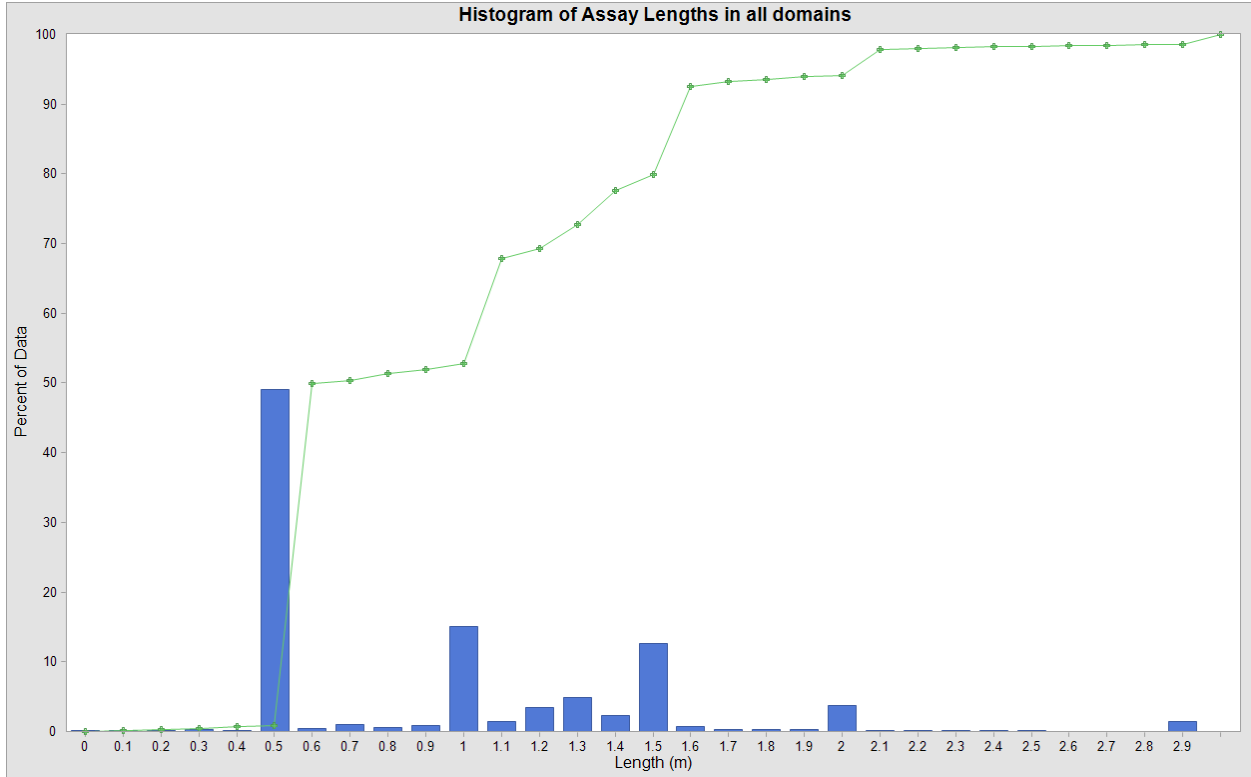
(Source: MMTS, 2023)

**Figure 14-6: Cumulative Probability Plot of Assays - Ag**

#### 14.4 Compositing

Compositing has been done on 5m composites, honoring the domain boundaries. This length is chosen to be larger than the majority of existing assay intervals within the domain, as illustrated in the histogram below (Figure 14-7). A comparison of the capped grade assay statistics to the capped composite statistics is given in Table 14-4. Where the composited weighted mean average grade differs from the weighted average mean assay grade, this is considered due to inclusion of zero values in the compositing and to the inclusion of additional assay intervals less than 2.5m at the boundary of the domain which have been included within the domain in order to reduce the occurrence of composite intervals less than 5m.

The Coefficient of Variation (C.V.) of the capped grades is generally below 2.0 for most metals and domains. Where it is large (Mo and Au), Outlier Restriction has been used during interpolation to reduce this variability within the domain.



(Source: MMTS, 2023)

**Figure 14-7: Histogram of Assay Lengths**



**Table 14-4: Summary of Capped Assay and Composites Statistics by Domain**

Metal	Source	Parameter	Domain				
			East	Bornite	Pass	Camp	Low Grade
Cu	Assays	Num Samples	12,410	3,708	186	49	8,187
		Num Missing	33	29	3	5	132
		Min (%)	0.000	0.001	0.001	0.026	0.000
		Max (%)	9.970	10.000	2.000	0.700	2.660
		Wtd. Mean (%)	0.206	0.302	0.437	0.397	0.103
		Wtd. CV	1.92	1.52	0.90	0.43	1.85
	Composites	Num Samples	2,254	588	82	42	1,704
		Num Missing	31	6	7	7	74
		Min (%)	0.000	0.000	0.010	0.050	0.000
		Max (%)	4.980	2.820	1.460	0.640	1.730
		Wtd. Mean (%)	0.206	0.276	0.448	0.361	0.096
		Wtd. CV	1.46	1.09	0.67	0.42	1.41
	DIFFERENECE (%)			0.1%	-8.5%	2.5%	-9.0%
Mo	Assays	Num Samples	12,408	3,696	181	44	8,183
		Num Missing	35	41	8	10	136
		Min (%)	0.000	0.000	0.000	0.000	0.000
		Max (%)	1.000	0.300	0.030	0.010	0.100
		Wtd. Mean (%)	0.010	0.007	0.003	0.002	0.002
		Wtd. CV	5.07	2.50	1.71	1.17	3.09
	Composites	Num Samples	2,254	585	74	29	1,697
		Num Missing	31	9	15	20	81
		Min (%)	0.000	0.000	0.000	0.000	0.000
		Max (%)	0.676	0.090	0.016	0.008	0.070
		Wtd. Mean (%)	0.010	0.007	0.003	0.002	0.002
		Wtd. CV	4.02	1.72	1.25	0.93	2.36
	DIFFERENECE (%)			0.3%	-8.1%	4.0%	-1.6%
Au	Assays	Num Samples	12,408	3,328	174	44	7,844
		Num Missing	35	409	15	10	475
		Min (gpt)	0.000	0.000	0.003	0.003	0.000
		Max (gpt)	10.000	8.000	0.200	0.100	2.000
		Wtd. Mean (gpt)	0.054	0.120	0.023	0.029	0.023
		Wtd. CV	6.30	3.55	1.51	0.96	3.35
	Composites	Num Samples	2,254	472	72	29	1,608
		Num Missing	31	122	17	20	170
		Min (gpt)	0.000	0.000	0.000	0.000	0.000
		Max (gpt)	6.130	3.370	0.160	0.100	0.900
		Wtd. Mean (gpt)	0.054	0.119	0.022	0.028	0.022
		Wtd. CV	4.67	2.17	1.24	0.85	2.41
	DIFFERENECE (%)			0.0%	-0.5%	-4.3%	-4.5%

Metal	Source	Parameter	Domain					
			East	Bornite	Pass	Camp	Low Grade	
Ag	Assays	Num Samples	12,408	3,560	173	44	8,096	
		Num Missing	35	177	16	10	223	
		Min (gpt)	0.010	0.010	0.010	0.030	0.005	
		Max (gpt)	50.000	50.000	10.000	3.690	10.000	
		Wtd. Mean (gpt)	0.873	1.350	1.131	1.078	0.336	
		Wtd. CV	2.77	2.36	1.26	0.96	2.16	
	Composites	Num Samples	2,254	533	70	29	1,672	
		Num Missing	31	61	19	20	106	
		Min (gpt)	0.020	0.030	0.040	0.060	0.010	
		Max (gpt)	37.370	17.740	7.250	3.600	10.000	
		Wtd. Mean (gpt)	0.872	1.288	1.126	1.079	0.326	
		Wtd. CV	2.15	1.62	1.00	0.88	1.50	
	DIFFERENECE (%)			-0.1%	-4.6%	-0.5%	0.1%	-3.0%

#### 14.5 Specific Gravity Assignment

Collection of specific gravity (SG) measurements on drill core samples used the same on-site procedure established and put into practise in 2014. SG measurements were completed on whole drill core samples greater than 10 centimeters in length (using the weight in air – weight in water method). A total of 395 SG measurements (over intervals ranging from 1 to 20m) were completed on cores from the Camp, Pass, and Bornite and East zones.

A total of 5,248 magnetic susceptibility measurements were taken on core samples using a Terraplus Model KT-10 unit in 2018. The magnetic susceptibility measurements (in 10<sup>-6</sup> SI Units) were taken over 1-3m intervals. It was found that the magnetic susceptibility for the same lithology can vary considerably due mainly to the degree of alteration and to a lesser extent magnetite content; mafic dikes consistently showed higher magnetic susceptibility (Stewart, 2018).

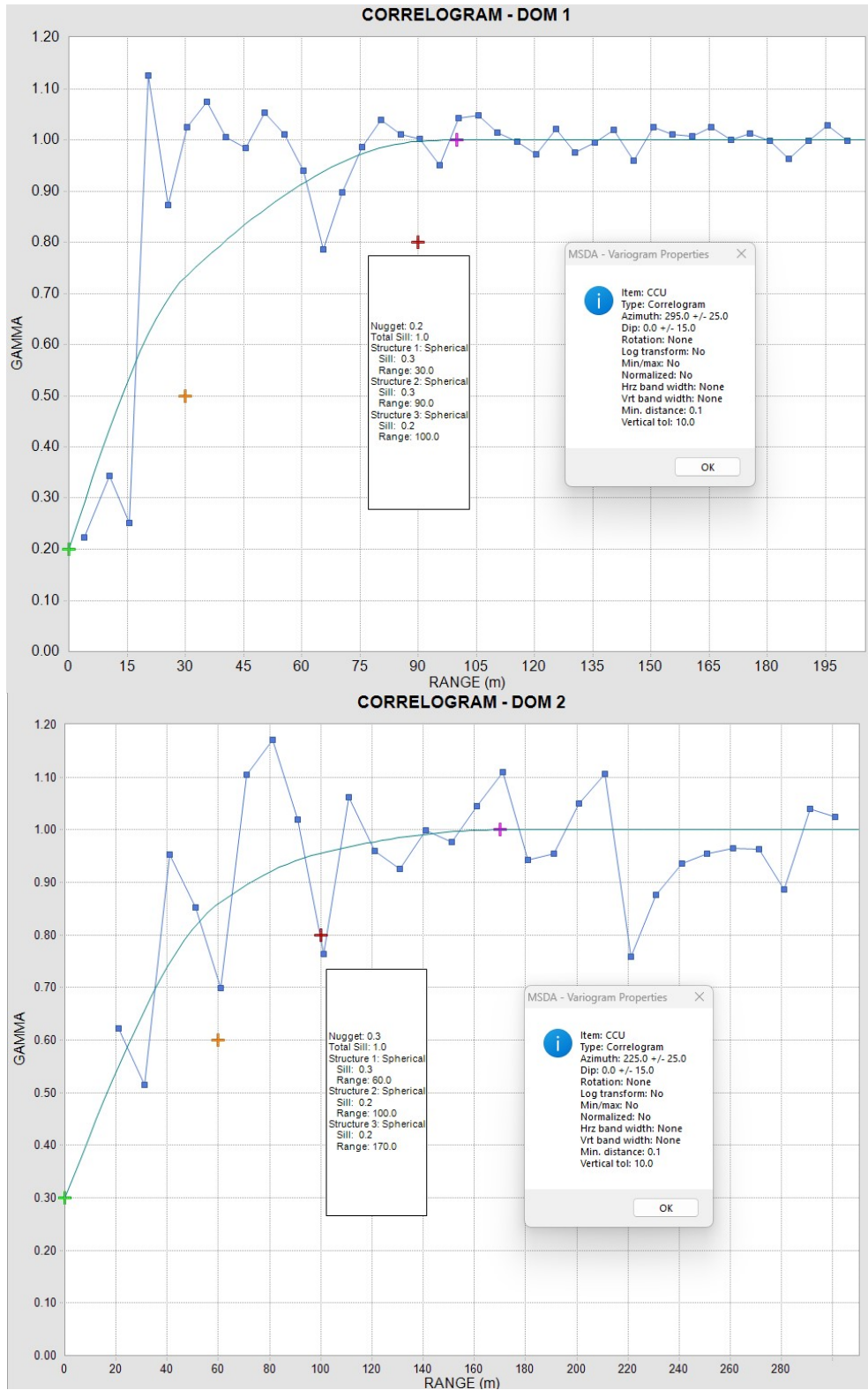
Table 14-5 shows the minimum, maximum, weighted mean SG for the lithologies and modelled in 2023, based on 4,775 measurements within the modelled volume.

**Table 14-5: Specific Gravity Measurements by Lithology**

Parameter	Lithology			
	Biotite - Granodiorite	Hornblende- Qtz Diorite	Qtz Porphyry	Volcanics
<b>Num Samples</b>	3,737	784	218	36
<b>Num Missing</b>	19,021	1,642	1,062	406
<b>Min</b>	2.16	2.57	2.59	2.59
<b>Max</b>	3.57	2.83	2.88	2.78
<b>Weighted mean</b>	2.66	2.70	2.67	2.72
<b>Weighted CV</b>	0.019	0.015	0.016	0.015

## **14.6 Variography**

Variograms for each metal and for domain 1 and 2 (East and Bornite zones) of the main high grade mineralized zones have been done to assist with the direction of anisotropic for searches, to help define suitable search distances used in each pass of the interpolations, and for determination of spatial variance for Classification. The figure below illustrates an example of the variograms for the major and minor axes of Domain 1 for Cu.



(Source: MMTS, 2023)

**Figure 14-8: Variogram Models for Domain 1 and 2 - Cu – Major Axes**

## 14.7 Block Modelling

Block dimensions are 10m x 10m x 10m with the extent of the block model summarized in Table 14-6.

**Table 14-6: Eaglehead Block Model Extents**

Directions	Minimum	Maximum	Size	Number
<b>Easting</b>	491,000	496,000	10	500
<b>Northing</b>	6,481,500	6,484,500	10	300
<b>Elevation</b>	900	1,950	10	105

Search parameter orientations varied based on the mineralized zone orientations. The rotation values Major, Minor and Vertical are the rotation of the principal axes about the Y-axis, X-axis, and Z-axis, respectively, using the right-hand rule with positive rotation upwards. Interpolation has been done using inverse distance (ID2) in all cases.

The restrictions on search distances and composite selection for each of the four passes of the interpolations are given in Table 14-7.

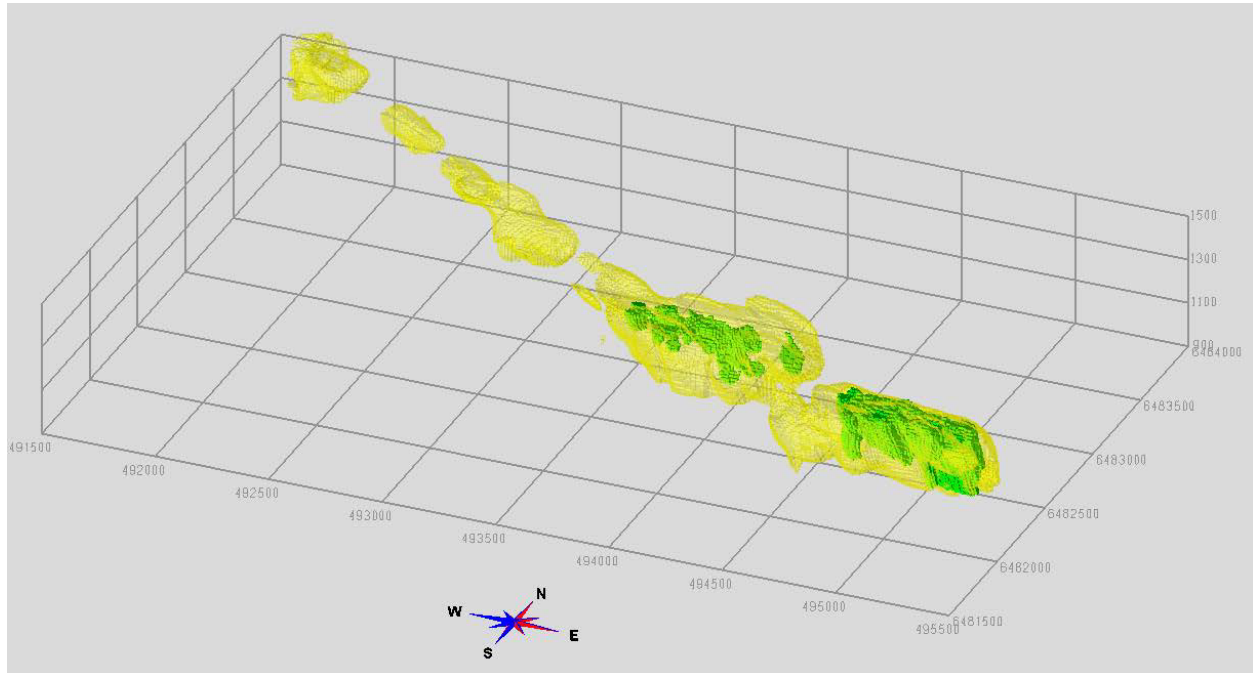
The interpolations have also restricted the high-grade outliers to ensure that metal content is not over-estimated in any domains. The outlier values are summarized in Table 14-7 along with the capping values, for clarity on how the high grades are constrained. Composite values above the Outlier values are used in the interpolations only up to 5m from the composite.

**Table 14-7: Summary of Search Orientations and Distances for each Pass**

Metal	Domain	Rotation Axis	Rotation	Distance (m)				
				Pass 1	Pass 2	Pass 3	Pass 4	Pass 5
All	1	Y	295	30	60	75	100	150
		X	0	15	80	100	150	225
		Z	-85	10	40	50	80	120
	2	Y	225	30	60	75	100	150
		X	0	15	80	100	150	225
		Z	-60	10	40	50	80	120
	3	Y	300	30	60	75	100	150
		X	0	15	80	100	150	225
		Z	-80	10	40	50	80	120
	4	Y	300	20	45	56	120	180
		X	0	10	15	19	100	150
		Z	-80	10	60	75	90	135
<b>Minimum # Composites</b>				4	4	4	4	2
<b>Maximum # Composites</b>				12	12	12	12	8
<b>Maximum # / DH</b>				2	2	2	2	1

## 14.8 Classification

The resource estimate is classified as Indicated if the block is within the East Zone or the Bornite Zone and has at least 2 composites with an average distance of 50m, with the furthest of the not more than 70m away. The other zones are considered Inferred. Figure 14-9 illustrates the Classification. No blocks are considered as Measured for the resource estimate.



(Source: MMTS, 2023)

**Figure 14-9: Three-dimensional view of the resource pit with the Classification (Indicated in green, Inferred in Yellow)**

## 14.9 Model Validation

### 14.9.1 Global Grade Validation

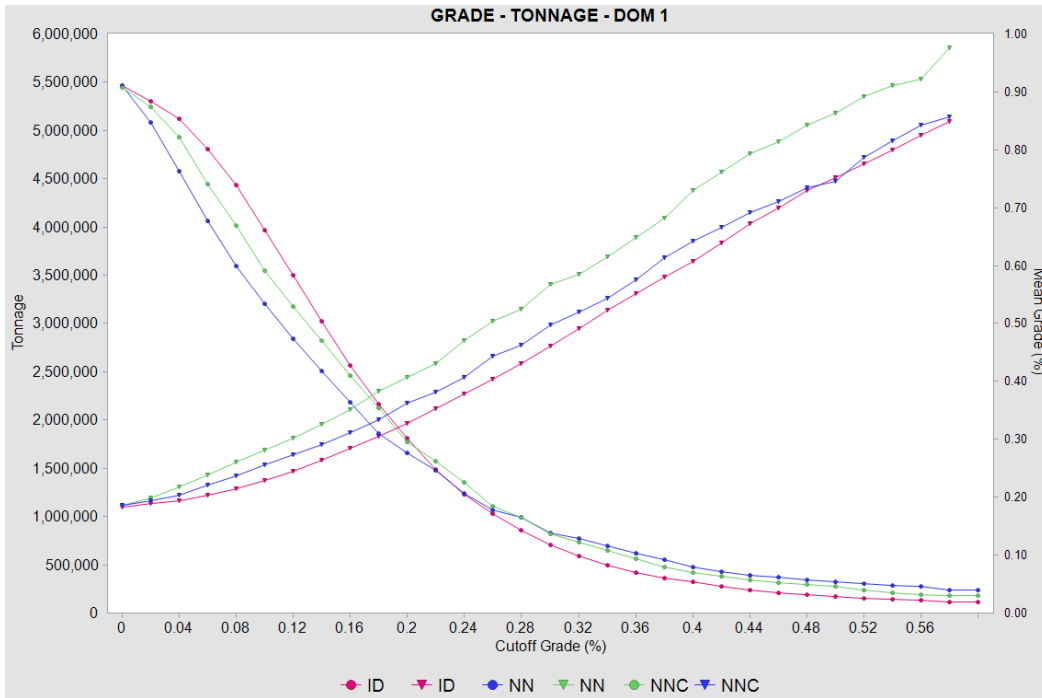
The Resource has been validated to ensure there is no global bias compared to the de-clustered composite values. The Nearest neighbour model is considered a proxy of the de-clustered composite data. Table 14-8 summarizes this comparison, illustrating that the difference between the de-clustered composite data (NN model) and the final modelled grades is minimal for each domain and metal, with the modelled grades slightly conservative compared to the NN model.

**Table 14-8: Model Validation of Global Model Grades with De-clustered Composites**

Domain	Source	Cu			Mo			Au			Ag		
		Wtd Mean (%)	Wtd CV	Diff. (%)	Wtd Mean (%)	Wtd CV	Diff. (%)	Wtd Mean (%)	Wtd CV	Diff. (%)	Wtd Mean (%)	Wtd CV	Diff. (%)
1	Model	0.183	0.82		0.0078	2.60		0.043	2.29	-	0.760	1.13	
	NN	0.185	1.32	-1.1%	0.0077	4.35	0.8%	0.049	9.52	12.2%	0.766	1.97	-0.8%
2	Model	0.237	0.69		0.0052	1.26		0.092	1.50		0.926	1.10	
	NN	0.239	1.05	-0.9%	0.0052	1.88	0.0%	0.090	2.45	3.2%	0.924	1.81	0.2%
3	Model	0.238	0.82		0.0019	1.30		0.015	1.27	-	0.573	0.81	
	NN	0.241	0.95	-1.4%	0.0019	1.72	-1.1%	0.018	1.92	17.8%	0.600	1.16	-4.5%
4	Model	0.282	0.60		0.0011	0.98		0.020	1.00	-	0.602	1.10	
	NN	0.279	0.69	1.1%	0.0013	2.56	11.0%	0.024	1.36	13.8%	0.655	1.38	-8.1%
5	Model	0.053	1.81		0.0009	4.14		0.011	3.23		0.166	2.11	
	NN	0.053	2.25	0.2%	0.0009	6.35	-3.4%	0.011	6.74	-5.2%	0.169	3.03	-1.8%
All	Model	0.092	1.55		0.0023	3.62		0.022	2.91		0.326	1.85	
	NN	0.092	1.98	-0.5%	0.0023	5.61	-0.6%	0.023	6.79	-5.7%	0.330	2.73	-1.2%

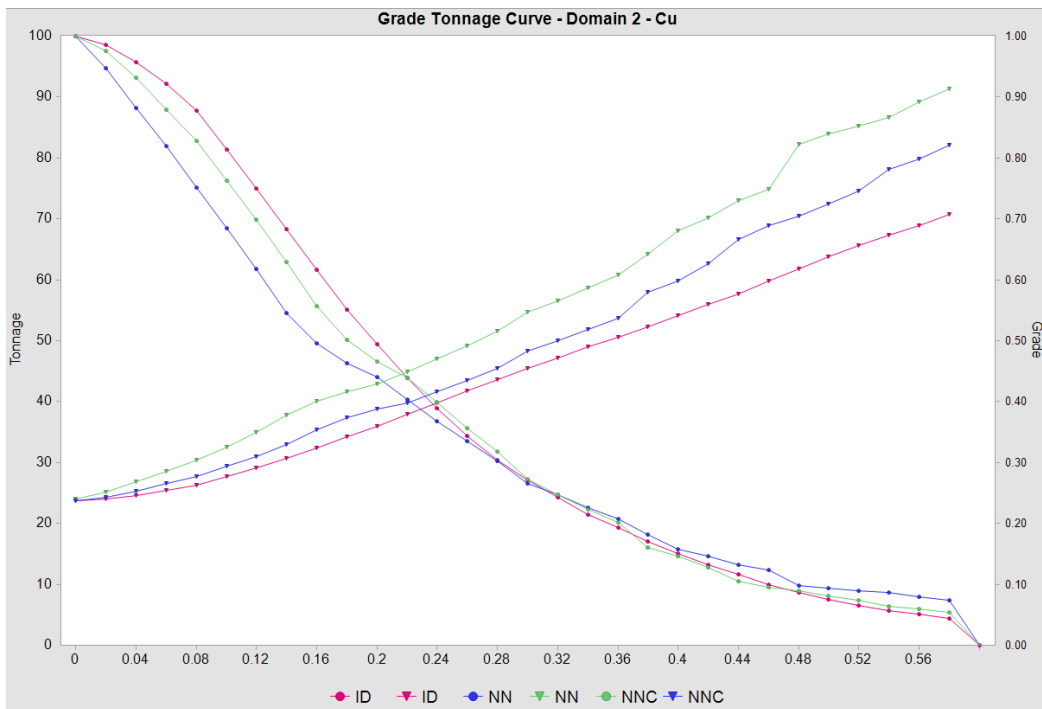
### 14.9.2 Grade-Tonnage Curves

Grade-tonnage curves were also created to compare interpolated Cu grades with the de-clustered composite grades through the grade distribution. Figure 14-10 and Figure 14-11 illustrate this comparison for Cu in domains 1 and 2, showing increased smoothing (reduced grades and increased tonnage) compared to the NN grade curves. The NN model has also been corrected for Volume-Variance effects using the Indirect Lognormal correction (ILC) to account for the reduction in variance from composite sample size to block size, as illustrated in the Grade-Tonnage figures. The final modelled grades (labelled ID in the figures) are at or below the Volume-Variance corrected Grade-tonnage curves (labelled NNC) throughout the grade distribution.



(Source: MMTS, 2023)

**Figure 14-10: Grade-Tonnage Curve Comparison for Cu – Domain 1**



(Source: MMTS, 2023)

**Figure 14-11: Grade-Tonnage Curve Comparison for Cu – Domain 2**



### 14.9.3 Visual Comparisons

The modelled grades have been compared to the assay and composited grades in section, plan, and three-dimensional views to ensure that the grades are spatially consistent. The figures below illustrate this comparison on N-S sections for Cu (two locations), Au, Mo, and Ag respectively.

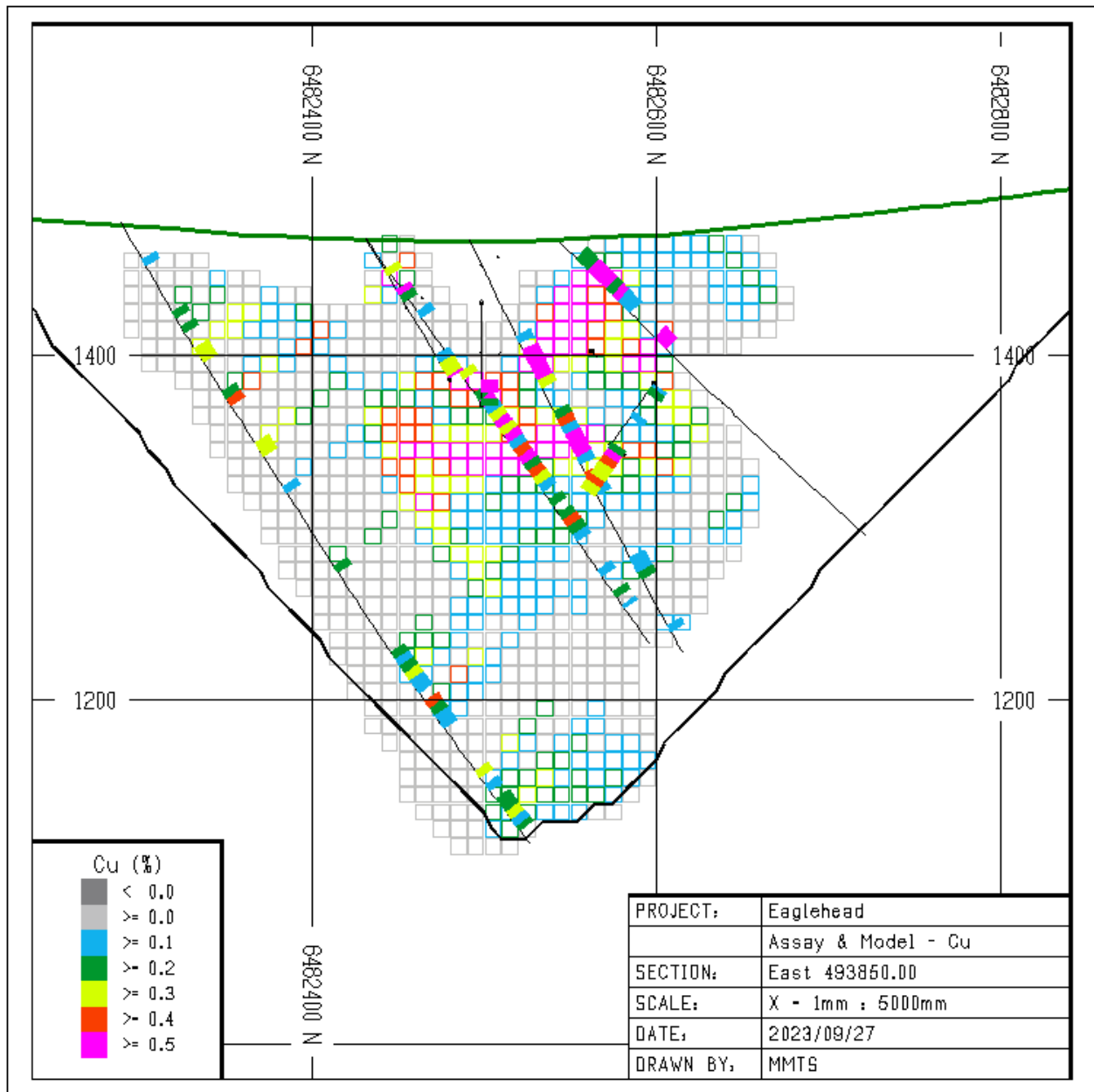


Figure 14-12: Composites (+/- 25m) and Model Grades at 4938350E - Cu

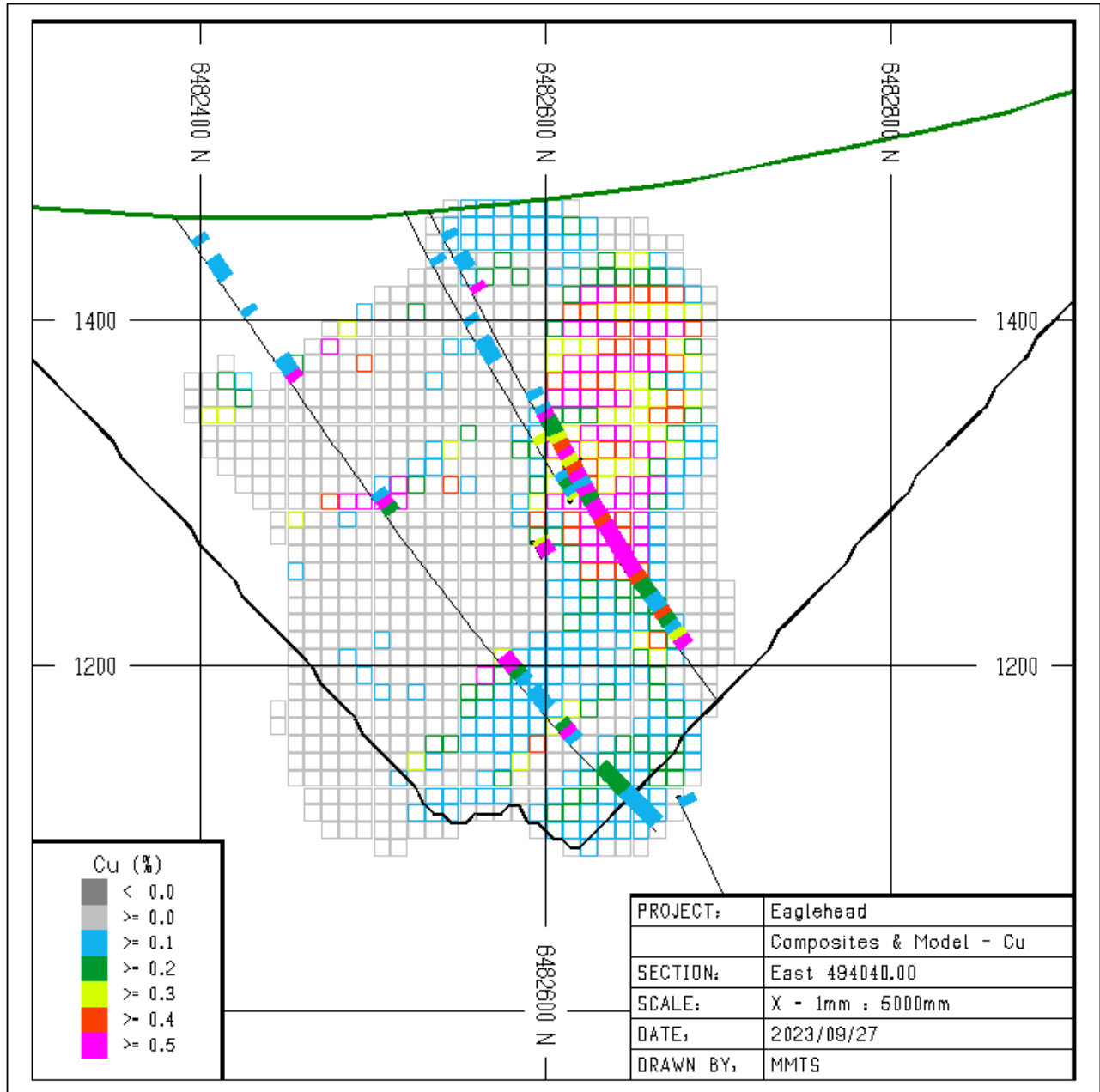


Figure 14-13: Composites (+/- 25m) and Model Grades at 494040E - Cu

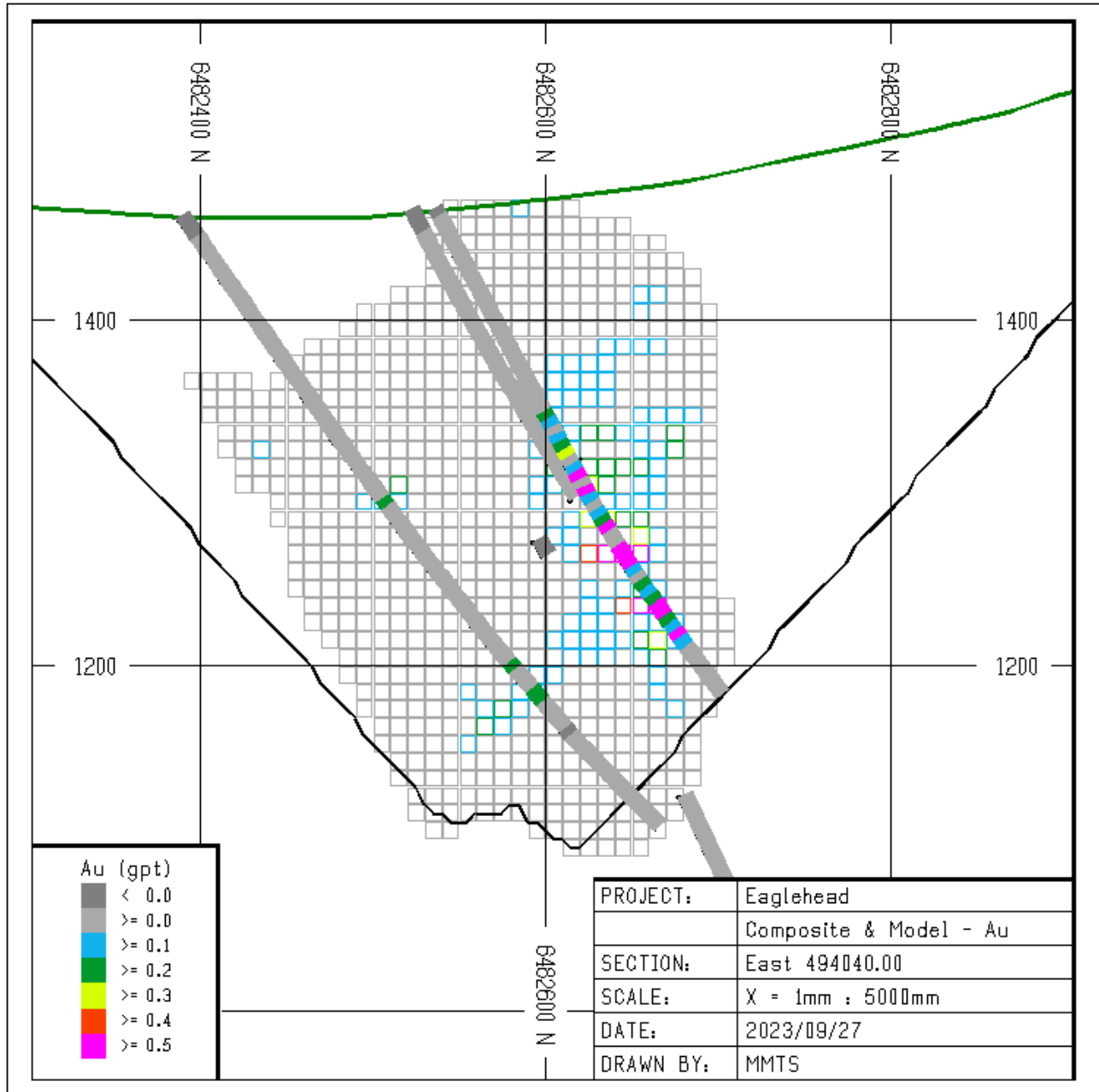


Figure 14-14: Composites (+/- 25m) and Model Grades at 494040E – Au

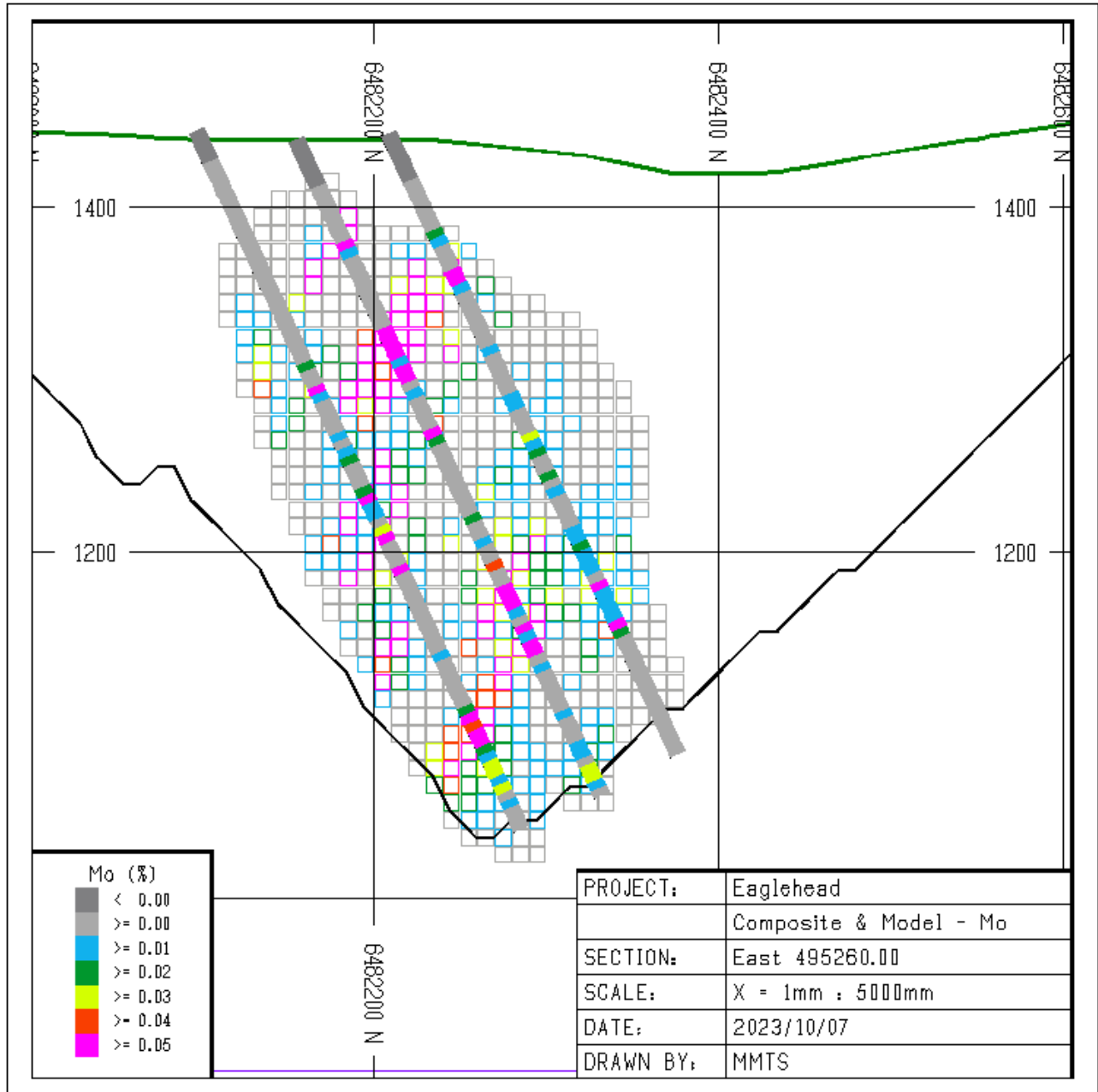


Figure 14-15: Composites (+/- 25m) and Model Grades at 495260E – Mo

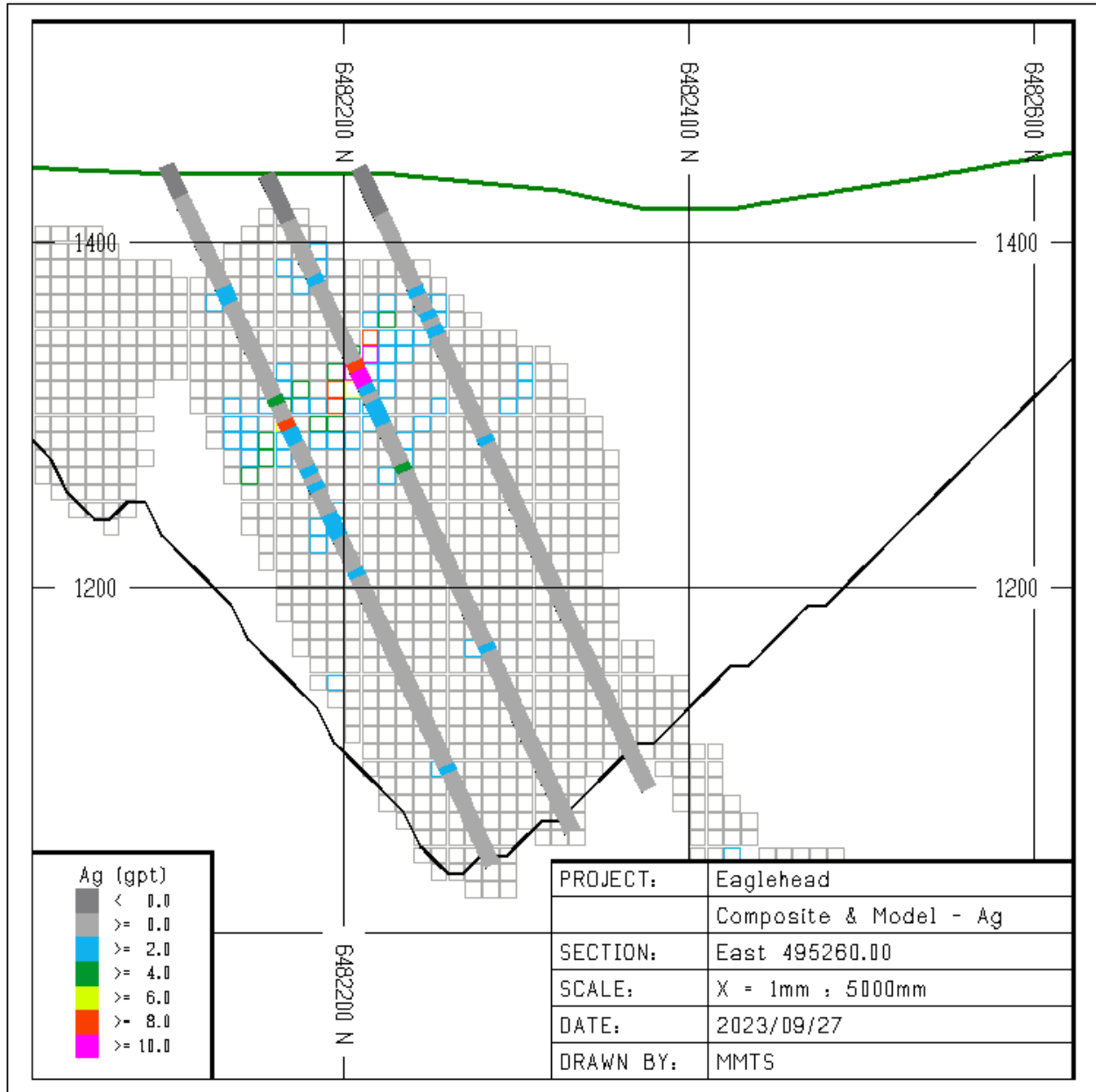


Figure 14-16: Composites (+/- 25m) and Model Grades at 495260E – Ag

### 14.10 Reasonable Prospects of Eventual Economic Extraction

The metal prices, recoveries, smelter terms and net smelter prices (NSP) are summarized in Table 14-9, which also summarizes the mining and processing costs. Pit slopes are assumed to be 50 degrees. Metal prices for both Au and Ag are based on the Kitco 3-year trailing average price charts (Kitco, 2023) have been used.

The resulting NSR equation is:

$$\text{NSR} = 22.0462 * (\text{Cu}\% * \text{CDN}\$3.83/\text{lb} * 89.9\% + \text{Mo}\% * \text{CDN}\$ 23.58 * 71.1\%) + \text{Augpt} * \text{CDN}\$70.55/\text{g} * 78.6\% + \text{Aggpt} * \text{CDN}\$ 0.74/\text{g} * 78.1\%$$

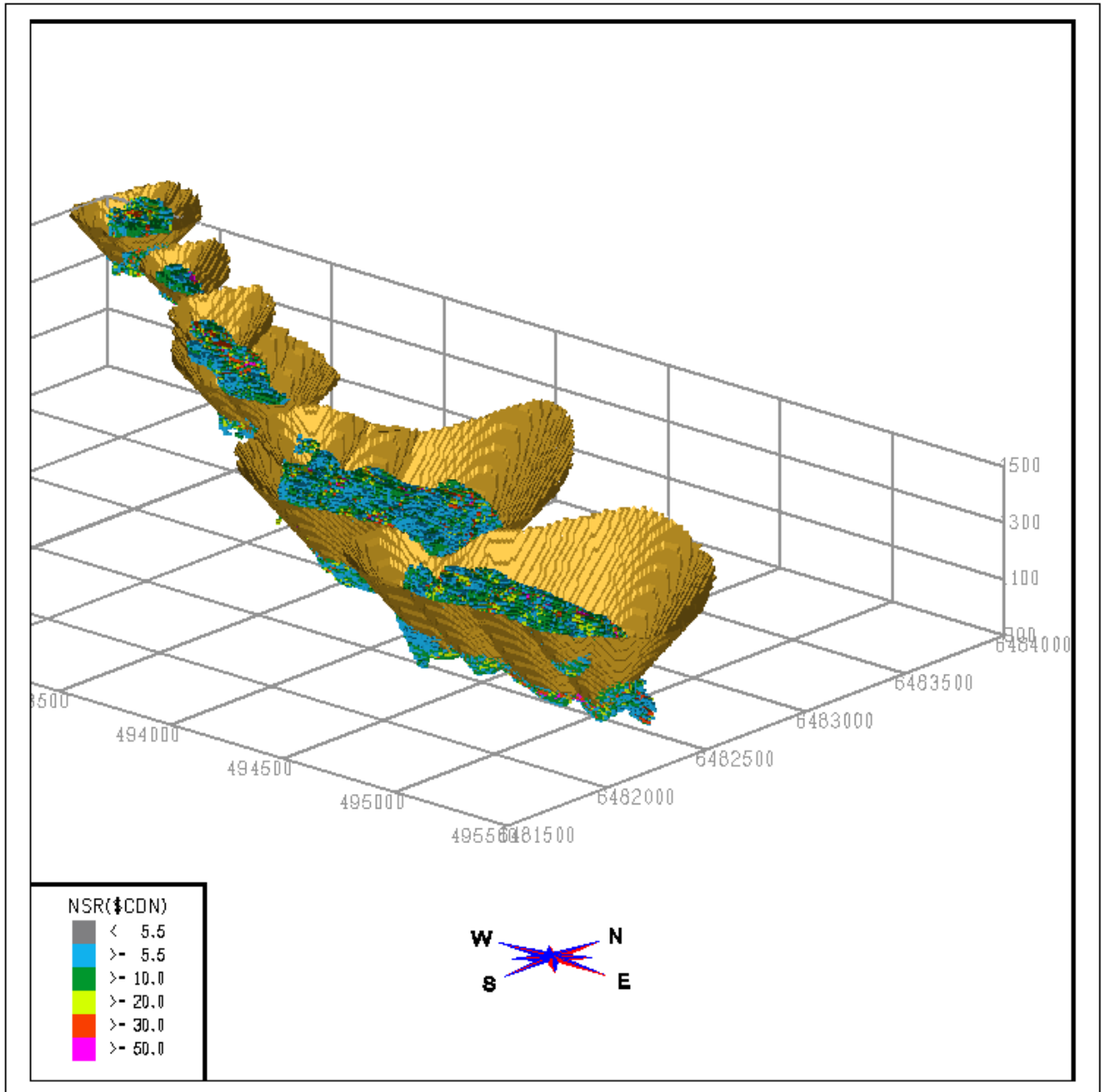
The resulting Copper Equivalent (CuEq) equation is:  
 $CuEq = Cu\% + Mo\% * 4.870 + Augpt * 0.7308 + Aggpt * 0.0076$

**Table 14-9: Metal Prices, Recoveries, Smelter Terms and Net Smelter Price (NSP)**

Input Parameter	Value	Units
Forex	0.77	USD per CAD
Cu Price	3.5	US\$/lb
Au Price	1750	US\$/oz
Ag Price	20	US\$/oz
Mo Price	20	US\$/lb
Cu Recovery	89.9%	%
Cu ConTransport	100	US\$/t con
CuConGrade	29.6%	%
Con Grade Unit Deduct	1%	%
Cu Con Treatment	120	US\$/t con
Cu refining	0.1	US\$/ lb Cu
<b>Cu NSP</b>	<b>3.83</b>	<b>CDN\$/lb</b>
Mo recovery	71.1%	
Mo Con Transport	154.05	\$US/t con
Mo Con grade	50%	%
Mo % Payable	99%	%
treatment	2.5	US\$/t con
refining	1.52	US\$/lb Mo
<b>Mo NSP</b>	<b>23.58</b>	<b>CDN\$/lb</b>
Au Recovery	78.6%	%
Au Payable	97.0%	%
Au Transport is with Cu Con	0.0	US\$/t con
Au Refining	8	US\$/oz
<b>Au NSP</b>	<b>70.55</b>	<b>CDN\$ / gram</b>
Ag Recovery	78.1%	%
Ag Payable	90%	%
Ag Transport is with Cu Con	0.0	US\$/t con
Ag Refining	0.5	\$/oz
<b>Ag NSP</b>	<b>0.74</b>	<b>CDN\$ / gram</b>
Processing + G&A + Tailings Cost	5.5	\$/tonne
Mining cost	1.5	\$/tonne

Open pit resources are confined by a “reasonable prospects of eventual economic extraction” shape defined by a Lerchs-Grossman pit using the 120% case of the NSPs in the Table above.

The final resource pit with modelled NSR grades above the base case cutoff of CDN\$15.00/tonne is illustrated in Figure 14-17.



(Source: MMTS, 2023)

**Figure 14-17: Three-dimensional view looking NW of the Resource Pit showing Modelled NSR above Cutoff**

### 14.11 Independent Check

An independent check on the modelling has been done by George Dermer, P.Eng of MMTS who checked:

- the resource shapes
- the model coding
- the “reasonable prospect” pit shapes and inputs
- the interpolation runs

## 14.12 Risk Assessment

A description of potential risk factors is given in Table 14-10 along with either the justification for the approach taken or mitigating factors in place to reduce any risk.

**Table 14-10: List of Risks and Mitigations/Justifications**

#	Description	Justification/Mitigation
1	Classification Criteria	Based on Variography
2	Geologic Model	Geologic interpretations and orientations were considered when creating new confining shapes for the resource interpolations.
3	Metal Price Assumptions	Cutoff is based on US\$3.50/lb Cu, US\$20/lb Mo, US\$1750/oz Au, and US\$20/oz Ag.
4	High Grade Outliers	Capping and outlier restriction applied to ensure mean grades match the de-clustered data. Grade-tonnage curves show model validates well with de-clustered composite data throughout the grade distribution. Visual validations also ensured high grades did not overly influence surrounding blocks in the model.
5	Processing and Mining Costs	Assumed from comparables. Cutoff grade more than covers Processing plus G&A costs





## **15 Mineral Reserve Estimates**

There are no mineral reserve estimates for the Eaglehead Cu-Mo-Au-Ag Project.



## **16 Mining Method**

This section is not applicable.



## **17 Recovery Methods**

This section is not applicable.



## **18 Project Infrastructure**

This section is not applicable.



## **19 Market Studies and Contracts**

This section is not applicable.



## **20 Environmental Studies, Permitting and Social or Community Impact**

This section is not applicable.



## **21 Capital and Operating Costs**

This section is not applicable.



## **22 Economic Analysis**

This section is not applicable.

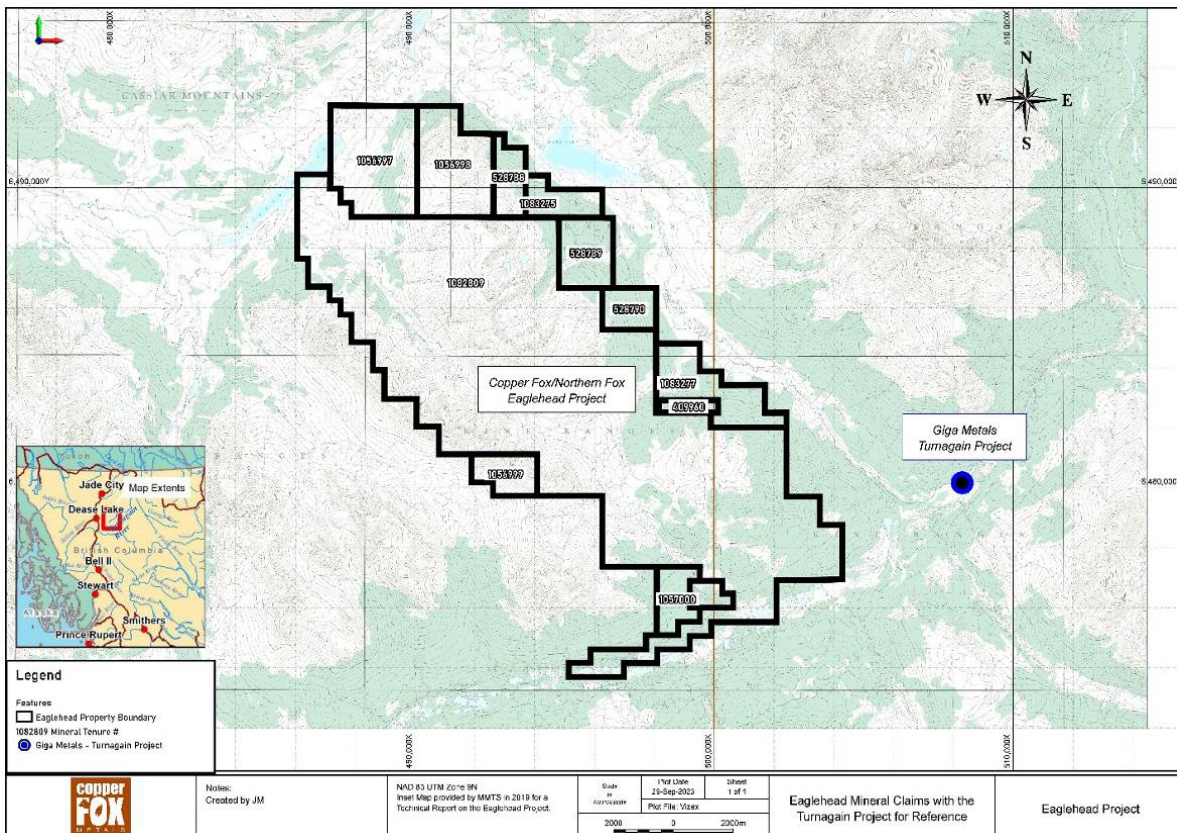


### 23 Adjacent Properties

The Turnagain Nickel-Cobalt Project is located immediately east of and adjoins the Eaglehead Project (Figure 23-1). The Turnagain project is owned by Hard Creek Nickel Corp, a joint venture between Giga Metals (85%) and Mitsubishi Corporation (15%). The Turnagain Project covers the Turnagain ultramafic complex, and contains zones of semi-massive, massive, and disseminated sulphides, near the southern and eastern margins of the ultramafic body. The Turnagain ultramafic body occurs within Paleozoic metasedimentary and metavolcanic rocks adjacent to the faulted terrane boundary between the margin of the North American craton and accreted Quesnel terrane. A 2023 Pre-Feasibility Study (PFS) prepared in accordance with National Instrument 43-101 for the Turnagain Nickel-Cobalt Project yielded a Pre-tax IRR and NPV of 11.1% and \$717M (7% discount rate) and post-tax IRR and NPV of 11.4% and \$574M at a long-term nickel price of \$9.75/lb, with 78% payable for nickel in concentrate.

The PFS contained a Proven and Probable Mineral Reserve of 950Mt grading 0.205% nickel, 0.013% cobalt, 0.022gpt platinum and 0.022gpt, palladium, a measured and indicated mineral resource containing 1,119.4Mt averaging 0.207% nickel, 0.013% Co, 0.020gpt, platinum and 0.022gpt, palladium and an inferred mineral resource containing 1,1163.8Mt averaging 0.206% nickel, 0.012% cobalt, 0.016gpt platinum and 0.018gpt palladium (source: Giga Metals News Release dated September 23, 2023.)

The QP has not reviewed or verified these mineral reserves and resources.



**Figure 23-1: Location of Turnagain Property in Relation to the Eaglehead Project**

## **24 Other Relevant Data and Information**

The author has reviewed the sources of information cited in the text and list in the Section 27 of this report. The information includes written descriptions, drillhole logs, cross-sections and property maps produced by various operators on the Eaglehead Project. Some of the reports reviewed are public assessment reports available through the B.C. Ministry of Energy and Mines **Assessment Report Indexing System (ARIS)**, while others are internal reports completed by the property operator. The author is not aware of any additional sources of information that might significantly change the conclusions presented in this Report.

The writer is not aware of any foreseeable extraordinary difficulties that could hamper additional exploration activities on the Eaglehead Project.

## **25 Interpretation and Conclusions**

### **25.1 Mineral Resource Estimate**

- The mineral resource estimate for the Project conforms to industry best practices, and meets the requirements of CIM (CIM, 2014) following the updated CIM guidelines (CIM, 2019).
- The estimate is based upon a geologic block model that incorporates 30,827 metres of assays from 126 drillholes.
- The majority (84%) of the drilling has been re-assayed in recent years.
- The Mineral Resource estimate is based on reasonable assumptions of eventual economic extraction and assuming open pit mining method. An NSR cutoff value of CDN\$5.5/tonne as the base case cutoff.
- Measured and Indicated Mineral Resources total 71 Mt at 0.33% CuEq and \$CDN24.74/tonne.
- Inferred Mineral Resources are estimated at 242 Mt grading 0.25% CuEq and \$CDN18.64/tonne.
- The following factors could affect the Mineral Resources: commodity price and exchange rate assumptions; pit slope angles and other geotechnical factors; assumptions used in generating the LG pit shell, including metal recoveries, and mining and process cost assumptions.

### **25.2 Geology and Exploration**

The Eaglehead Project covers an open-ended, calc-alkalic porphyry copper-molybdenum-gold-silver system of significance contained with variably altered porphyritic phases of the Eaglehead Pluton.

The work completed in 2021 and 2022 have resulted in a better understanding of geology, alteration, mineralogical associations, vein relationships and timing on emplacement of the Eaglehead pluton and subsequent mineralizing event.

The Project is at an intermediate to advanced stage of exploration. The porphyry copper system hosts four open-ended porphyry deposits and two areas of widespread porphyry style mineralization hosted in an 8 km long mineralized corridor. The mineralized corridor has been defined by grid-base soil geochemical sampling, modern ground-based and airborne geophysical surveys, re-logging of the majority of the 126 diamond drillholes, a historical NI 43-101 mineral resource estimate and preliminary metallurgical test work.

Exploration has identified six zones of porphyry style copper-molybdenum-gold-silver mineralization; from southeast to northwest, they are the Far East, East, Bornite, Pass, Camp and West zones. These zones occur within a prospective, northwest trending mineralized corridor, from 2.5 – 3.0km wide and in excess of 8km long, along the western margin of the Early Jurassic Eaglehead pluton.

### **25.3 Risks, Opportunities and Uncertainties**

This report is based on the best information and data available at the time of writing. Certain risks, opportunities and uncertainties are inherent for all early-stage mineral exploration projects.

#### **25.3.1 Risks and Uncertainties**

Risks and uncertainties associated with mineral exploration that could cause actual events or results to differ from those expressed or implied in this report include:

- potential delays in obtaining, or failure to obtain or maintain exploration and development permits;

- challenges related to obtaining adequate financing for exploration and development;
- interpretation of, and statistical conclusions drawn from, diamond drilling, sampling, geologic interpretation, and grade and continuity of mineralization;
- future geological modelling and estimated mineral resources;
- prospects for economic viability including factors such as metallurgical recoveries, fluctuating metal prices, lower than expected grades and quantities of resources, increases to capital costs and operating costs;
- unexpected changes related to governmental regulations, including environmental regulations.

### **25.3.2 Opportunities**

Opportunities identified on the Eaglehead Project that may have a positive impact include:

- the mineral resource estimate identified four open-ended zones of porphyry style mineralization that with continued drilling could expand the mineralized envelope thus potentially adding additional resources to the project.
- further geophysical surveys in the area north of the Camp and Pass zones to further define the chargeability anomaly located in 2021 could provide a better understanding of the geometry and dimensions of the porphyry system and add new drilling targets.
- applying new geological models to guide future exploration on the Project and to enhance the likelihood of expanding the continuity of the mineralization of existing zones as well as identifying new targets.

## **26 Recommendations**

The following recommendations comprise a comprehensive exploration program that will provide important new geological baseline data (surveying, bedrock mapping, and geophysical surveying), provide a framework for future exploration (deposit modelling and drillhole re-logging) and drill test specific exploration targets.

The resource estimate included within this Technical Report indicates that all zones of mineralization are open-ended. Additional drilling is required to delineate the mineralized envelope in each zone. The positive chargeability anomaly suggests that the mineralization is continuous between the Bornite and East zones. The untested gap between the Bornite and East zones is approximately 500m. This gap should be drill tested to determine continuity of the mineralization between these two zones.

### **26.1 Surveying**

A LiDAR survey should be flown over the central part of the Project from south of the Far East zone to north of the West zone and well east of the known extent of mineralization to include the ridges and valleys east of the Pass zone. Alternatively, a drone DEM survey of the same area would provide useful high-resolution orthophotos for mapping purposes and accurate elevations for drilling and deposit modeling.

Permanent markers have been established at the collars of historical drillholes that have been located. All drillhole collars have been surveyed to a high degree of accuracy (northing, easting and elevation) meeting engineering standards. This survey should be updated if additional diamond drilling is completed.

### **26.2 Bedrock Mapping**

The reconnaissance mapping completed in 2021 and 2022 delineated the distribution of the main intrusive phases and distribution of the alteration phases. Additional mapping should be completed in the area north of the Camp and Pass zone to further delineate the copper showings and alteration patterns. This work would be beneficial in understanding the significance of the large positive chargeability located at depth under the mineral showing. Additional mapping is also recommended in the area referred to as the Cirque to better understand the significance of the Listwanite in this area.

### **26.3 Geophysical Surveys**

The 2021 Quantec Titan24 survey should be expanded in multiple directions: to the northwest and to the southeast to fully include the West zone and its potential extensions, to the east to include the ridge and valley areas east of the Pass zone, and to the southeast to fully include the Far East zone. It is recommended that the Orion Swath configuration be utilized.

### **26.4 Deposit Modelling**

Additional updating of the three-dimensional modelling of lithology, alteration, structure, and sulphide species including petrography, QEMSCAN, whole rock and trace element geochemistry should continue to better understand the geometry and controls on the mineralization in each mineralized zone.

### **26.5 Metallurgical Testwork**

Additional metallurgical testwork should be completed. The test samples should be representative of the various lithologies, alterations and grade classes for copper, molybdenum, gold, and silver mineralization. Testwork to collect additional Bond Work Index (BWi) and Abrasion Index (Ai) information for the various

rock types and styles of mineralization in the Eaglehead deposit as well as more variability and locked cycle tests should also be conducted following the recommendation of SGS. Copper-molybdenum separation testing is also recommended on the final rougher flotation concentrate to better inform meta recoveries and quality of the copper and molybdenum concentrates.

## **26.6 Diamond Drilling**

It is recommended that a Phase 1 diamond drilling program be directed to assess the following priority exploration target:

- The gap between the East and Bornite zones to test for continuity of mineralization between the two zones (4 drillholes; 2,000m). The current interpretation of the Bornite and East zone is north-dipping. Based on deposit modeling and analysis of mineralized structures, the drilling should be directed to the SW. Contingent on the success of Phase 1 drilling outlined above, a follow-up phase of additional diamond drilling is recommended and includes:
- Evaluation of the deeper potential of both the East and Bornite zones as demonstrated by 2014 drilling (4 drillholes; 2,000m);
- Drilling of the deeper potential of the Pass zone as demonstrated by 2015 drilling (2 drillholes; 1,000m);
- Systematic re-drilling of the Camp zone which would include a number of the targets identified in the Titan24 survey (8 drillholes; 2,800m).

The recommended Phase 1 program has an estimated cost of \$1.7 million, as summarized in Table 26-1. The recommended budget for the Phase 2 drilling is summarized in Table 26-2.

**Table 26-1: Proposed Budget for Recommended Exploration Program – Phase 1**

<b>Activity</b>	<b>Cost</b>
Surveying	\$ 30,000
Deposit Modelling, QEMSCAN, Petrology (20 samples)	\$ 31,150
Metallurgical Test Work (approx. 10 @ 10,000/sample)	\$ 100,000
Phase 1 Diamond Drilling (2500m @\$178/m), incl. Pad Building and Road Prep	\$ 454,500
Helicopter Support (Primarily Drill and Camp Support)	\$ 186,800
Personnel (Management, Geologists, Geo-Techs)	\$ 242,800
Field Supplies and Rentals	\$ 63,300
Camp Accommodation & Meals	\$ 38,600
Travel	\$ 41,600
Fuel	\$ 99,700
Assaying (approx. 850 @ \$150/sample (prep and analysis (FA + 4-acid)))	\$ 127,500
QAQC	\$ 25,000
Reporting	\$ 50,000
General Agreements and Archaeology	\$ 74,000
<b>Sub-Total</b>	<b>\$ 1,564,950</b>
Contingency (10%)	\$ 156,495
<b>Total</b>	<b>\$ 1,721,445</b>

**Table 26-2: Proposed Budget for Recommended Exploration Program – Phase 2**

<b>Activity</b>	<b>Cost</b>
Surveying	\$ 45,000
Bedrock Mapping	\$ 15,000
Geophysical Survey	\$ 250,000
Deposit Modelling , QEMSCAN, Petrology (45 samples)	\$ 72,300
Metallurgical Test Work (approx. 25 @ 10,000/sample)	\$ 250,000
Phase 2 Diamond Drilling (5800m @\$178/m), incl. Pad Building and Road Prep	\$ 1,055,000
Helicopter Support (Primarily Drill and Camp Support)	\$ 433,400
Personnel (Management, Geologists, Geo-Techs)	\$ 563,300
Field Supplies and Rentals	\$ 146,900
Camp Accommodation & Meals	\$ 89,600
Travel	\$ 96,500
Fuel	\$ 231,300
Assaying (approx. 1950 @ \$150/sample (prep and analysis (FA + 4-acid)))	\$ 292,500
QAQC	\$ 58,000
Reporting	\$ 116,000
General Agreements and Archaeology	\$ 74,000
<b>Sub-Total</b>	<b>\$ 3,788,800</b>
Contingency (10%)	\$ 378,880
<b>Total</b>	<b>\$ 4,167,680</b>

## 27 References

- Agnerian, H. (2010): *Technical Report on the Eaglehead Cu-Mo Project, British Columbia, Report Prepared by Agnerian Consulting Ltd. for Carmax Mining Corp., December 20, 2010.*
- Ahlborn, V.H. and MacLean, K.A. (1971): *Report on the Eagle Group of Claims; British Columbia Department of Mines and Petroleum Resources, Assessment Report 3476, 51 pages.*
- Amec Foster Wheeler Americas Limited (2016): *Draft Report on QAQC Practices, Eaglehead Project; private report by G. Kulla for Carmax Mining Corp.*
- Bouzari, F. *Roundup 2020, MDRU SC 108: Vectoring to and Within Porphyry Copper Systems; Vancouver; Jan 18-19.*
- British Columbia Minister of Mines Annual Reports for 1963, 1964 and 1965.*
- Britten, R.M. and Marr, J.M. (1995): *The Eaglehead porphyry copper prospect, northern British Columbia; CIM Special Volume 46, pages 467-472.*
- Burton, A. and Walcott, P. (1979): *Geochemical and Geophysical Survey, Eaglehead Property; British Columbia Ministry of Energy and Mines, Assessment Report 7661, 68 pages.*
- Canadian Institute of Mining, Metallurgy and Petroleum (CIM), 2019, CIM Estimation of Mineral Resources and Mineral Reserves – Best Practices Guidelines, November 2019.*
- Canadian Institute of Mining, Metallurgy and Petroleum (2014): CIM DEFINITION STANDARDS – For Mineral Resources and Mineral Reserves, CIM Standing Committee on Reserve Definitions, adopted May 10, 2014.*
- Caulfield, D.A. (1982): *Alteration and sulphide assemblages, Eaglehead Porphyry Copper-Molybdenum Prospect, North-Central British Columbia; unpublished B.Sc. thesis, The University of British Columbia, Vancouver, British Columbia, 55 pages.*
- Everett, C.C., (1982): *Geological, Geochemical and Geophysical Report on the Eagle 1 Group, Liard Mining Division, for Esso Resources Canada Limited. BC Department of Mines and Petroleum Resources, Assessment Report 10816, 84 pages.*
- Gabrielse, H. (1994): *Geology of Cry Lake (104I) and Dease Lake (104J) map areas, north-central British Columbia; Geological Survey of Canada, Open File 2779.*
- Gabrielse, H. (1998): *Geology of Cry Lake and Dease Lake Map areas, North-Central British Columbia, Geological Survey of Canada, Bulletin 504.*
- Ikona, C.K. (2004a): *Technical Report on the Eaglehead Property for Carmax Exploration Ltd., filed on SEDAR, May 1, 2004, 20 pages.*
- Ikona, C.K. (2004b): *Valuation Report on the Eaglehead Property for Carmax Exploration Ltd., filed on SEDAR, May 5, 2004, 10 pages.*
- Ikona, C.K. and Scott, T.C. (1981): *Geophysical, Geochemical and Diamond Drilling Assessment Report on the Eaglehead Property; British Columbia Ministry of Energy and Mines, Assessment Report 8754, 120 pages.*
- Ikona, C.K. and Scott, T.C. (1982): *Geophysical, Geochemical and Diamond Drilling Assessment Report on the Eaglehead Property; British Columbia Ministry of Energy and Mines, Assessment Report 9645, 176 pages.*
- Marr, J.M. (1976): *Drilling Assessment Report on the Eagle Claims 112-139; British Columbia Ministry of Energy and Mines, Assessment Report 6086, 22 pages.*
- Marr, J.M. (1977): *Drilling Assessment Report on the Eagle Claims 47-79, 81, 83, 85, 87 and 89; British Columbia Ministry of Energy and Mines, Assessment Report 6192, 22 pages.*
- Marsh, T.M. (2018): *Controls on Copper Mineralization at the Eaglehead Cu-Au-Mo Porphyry, Liard Mining Division, British Columbia; private report for District Copper Corp., 48 pages.*
- Massey, N.W.D., MacIntyre, D.G., Desjardins, P.J. and Cooney, R.T. (2005): *Digital Geology Map of British Columbia: Whole Province, British Columbia Ministry of Energy and Mines, GeoFile 2005-1.*
- McDonough, B. and Rennie, D.W. (2012): *Technical Report on the Eaglehead Cu-Mo-Au Project, British Columbia, Canada; for Carmax Mining Corp. by Roscoe Postle Associates Ltd., 159 pages.*



- McPherson, M.D. (1991): *Geochemical Report on the Eagle 7 Claim; British Columbia Ministry of Energy and Mines, Assessment Report 20856, 30 pages.*
- McPherson, M.D. (1993): *Geochemical Report on the Eagle 92 Group, Eaglehead Property; British Columbia Ministry of Energy and Mines, Assessment Report 22760, 28 pages.*
- Mihalynuk, M.G., Zagorevski, A., English, J.M., Orchard, M.J., Bidgood, A.K., Joyce, N., and Friedman, R.M., 2017. *Geology of the Sinwa Creek area, northwest BC (104K/14). In: Geological Fieldwork 2016, British Columbia Ministry of Energy and Mines, British Columbia Geological Survey Paper 2017-1, pp. 153-178.*
- Panteleyev, A. (1964): *Geological and Geochemical Examinations, Snowdrift Exploration, Joy 1-32 Mineral Claims; British Columbia Ministry of Energy and Mines, Assessment Report 585A, 10 pages.*
- Panteleyev, A. (1995): *Porphyry Cu+/-Mo+/-Au, in Selected British Columbia Mineral Deposit Profiles, Volume 1 - Metallics and Coal, Lefebure, D.V. and Ray, G.E., Editors, British Columbia Ministry of Employment and Investment, Open File 1995-20, pages 87-92.*
- Poloni, J.R. (2002): *Assessment Report on the EH #1 - #5 Mineral Claims; British Columbia Ministry of Energy and Mines, Assessment Report 27054, 30 pages.*
- Poloni, J.R. (2004): *Assessment Report on the EH #1 - #13 Mineral Claims; British Columbia Ministry of Energy and Mines, Assessment Report 27588, 26 pages.*
- Poloni, J.R. and Chen, B. (2005): *Geophysical Report on the EH #1 - #17 Mineral Claims; British Columbia Ministry of Energy and Mines, Assessment Report 28125, 93 pages.*
- Poloni, J.R. (2006): *Assessment Report on the EH #1 - #17, #19 - #26 Mineral Claims; British Columbia Ministry of Energy and Mines, Assessment Report 28852, 130 pages.*
- Poloni, J.R. (2008a): *Assessment Report on the EH #1 - #17, #19 - #26, #30 - #35 Mineral Claims; British Columbia Ministry of Energy and Mines, Assessment Report 29897, 171 pages*
- Poloni, J.R. (2008b): *Assessment Report on the EH #1 - #17, #19 - #26, #30 - #35 Mineral Claims; British Columbia Ministry of Energy and Mines, Assessment Report 30428, 265 pages.*
- Poon, J. (2014): *Airborne Geophysical Survey Report, Eaglehead Survey Block; Precision GeoSurveys Inc., private report for Carmax Mining Corp., 49 pages.*
- Quantec Geoscience Ltd. (2014): *Titan 24 DC - IP Survey Geophysical Report, Eaglehead Property, Dease Lake, British Columbia; private report prepared for Carmax Mining Corp., 273 pages.*
- Quist, B. (2015): *2015 Assessment Report on drilling, geophysical and physical work completed on the Eaglehead claims; British Columbia Ministry of Energy and Mines, Assessment Report 35304, 1735 pages.*
- Riles, A. (2011): *Turnagain Project Preliminary Economic Assessment; National Instrument 43-101 Technical Report prepared for Hard Creek Nickel Corporation by AMC Mining Consultants (Canada) Ltd., 151 pages.*
- Scott, T.C. (1980): *Diamond Drilling Report of Eaglehead Property, Eaglehead Lake Area; British Columbia Ministry of Energy and Mines, Assessment Report 7826, 66 pages.*
- SGS Canada Inc. (2016): *An Investigation into the grindability and flotation testing of samples from the Eaglehead Project; private report prepared for Carmax Mining Corp., December 9, 2016, 175 pages.*
- Sillitoe, R.H. (2010): *Porphyry Copper Systems; Economic Geology, Volume 105, pp 3-41.*
- Stewart, E.B. (2016): *2016 Assessment Report on diamond drilling and the sampling, re-sampling and re-logging of historical diamond drillholes completed on the Eaglehead Project; British Columbia Ministry of Energy and Mines, Assessment Report 36271, 450 pages.*
- Stewart, E.B. (2018): *2018 Assessment Report on the Sampling, Re-Sampling and Re-Logging of Historical Diamond Drillholes on the Eaglehead Project; British Columbia Ministry of Energy and Mines, Assessment Report 35304, 956 pages.*
- Thorstad, L. and Gabrielse, H. (1986): *The Upper Triassic Kutcho Formation, Cassiar Mountains, north-central British Columbia; Geological Survey of Canada, Paper 86-16.*
- Walcott, P.E. (1972): *A Report on an Induced Polarization Survey Dease Lake Area, Eagle Mineral Claims; British Columbia Ministry of Energy and Mines, Assessment Report 4256, 20 pages.*