

## **Haib Copper Project 2020 Preliminary Economic Assessment**

**For**

**Deep-South Resources Inc.  
2906 West Broadway, Suite 162,  
Vancouver, BC. Canada V6K 2G8**

**Prepared by**

**Qualified Persons: –**

**Principal Author –**

**DAMIAN CONNELLY B.App.Sc. FAusIMM. (CP) Met. FIEAust.**

**Contributing Authors –**

**PETER W.A. WALKER B.Sc. (Hons.) MBA Pr.Sci.Nat. F.S.E.G. M.G.S.S.A.**

 **Walker Consultancy cc**

**DEAN S. RICHARDS B.Sc. (Hons.) Geol. Pr.Sci.Nat. M.G.S.S.A.**



**Effective Date: 12<sup>th</sup> January 2021**

**Report Date: 12<sup>th</sup> January 2021**



Haib Copper Project 2020 Preliminary Economic Assessment. The Haib Copper Project 2020 Preliminary Economic Assessment has been prepared using the Canadian National Instrument 43-101 Standards of Disclosure for Mineral Projects.

The Haib Copper Project 2020 Preliminary Economic Assessment has been prepared for Deep-South Resources Inc. (Deep-South) by Mineral Engineering Technical Services (METS); and P&E Walker Consultancy and Obsidian Consulting Services as the Report Contributors. The Haib Copper Project 2020 Preliminary Economic Assessment is based on information and data supplied to the Report Contributors by Deep-South and other parties. The quality of information, conclusions, and estimates contained herein is consistent with the level of effort involved in the services of the Report Contributors, based on: i) information available at the time of preparation, ii) data supplied by outside sources, and iii) the assumptions, conditions, and qualifications set forth in this report. Each portion of the report is intended for use by Deep-South subject to the terms and conditions of its contracts with the Report Contributors. Except for the purposes legislated under Canadian provincial and territorial securities law, any other uses of the report, by any third party, is at that party's sole risk.

The conclusions and estimates stated in the Haib Copper Project 2020 Preliminary Economic Assessment are to the accuracy stated in the Haib Copper Project 2020 Preliminary Economic Assessment Update only and rely on assumptions stated in the Haib Copper Project 2020 Preliminary Economic Assessment. The results of further work may indicate that the conclusions, estimates and assumptions in the Haib Copper Project 2020 Preliminary Economic Assessment need to be revised or reviewed.

The Report Contributors have used their experience and industry expertise to produce the estimates and approximations in the Haib Copper Project 2020 Preliminary Economic Assessment. Where the Report Contributors have made those estimates and approximations, they are subject to qualifications and assumptions and it should also be noted that all estimates and approximations contained in the Haib Copper Project 2020 Preliminary Economic Assessment will be prone to fluctuations with time and changing industry circumstances.

The Haib Copper Project 2020 Preliminary Economic Assessment should be construed in light of the methodology, procedures and techniques used to prepare the Haib Copper Project 2020 Preliminary Economic Assessment. Sections or parts of the Haib Copper Project 2020 Preliminary Economic Assessment should not be read or removed from their original context.

The Haib Copper Project 2020 Preliminary Economic Assessment is intended to be used by Deep-South, subject to the terms and conditions of its contract with the Report Contributors. Recognizing that Deep-South has legal and regulatory obligations, the Report Contributors have consented to the filing of the Haib Copper Project 2020 Preliminary Economic Assessment with Canadian Securities Administrators and its System for Electronic Document Analysis and Retrieval ("SEDAR").

## TABLE OF CONTENTS

1.	EXECUTIVE SUMMARY.....	1
1.1	Introduction.....	1
1.2	Location.....	1
1.3	Geology and Mineralisation.....	2
1.4	Exploration/Drilling.....	2
1.5	Mineral Processing and Metallurgical Testing.....	3
1.6	Mining Methods.....	3
1.7	Metallurgical Testwork.....	4
1.8	Recovery Methods.....	4
1.9	Marketing.....	5
1.10	Environmental and Permitting.....	5
1.11	Capital and Operating Costs.....	5
1.12	Economic Analysis.....	7
1.13	Recommendations.....	8
2.	INTRODUCTION.....	9
2.1	Purpose.....	9
2.2	Sources of Information.....	9
2.3	Site Visit.....	9
2.4	References.....	10
3.	COUNTRY AND REGIONAL SETTINGS.....	11
3.1	General.....	11
3.2	Accessibility.....	11
3.3	Local Resources and Infrastructure.....	11
3.4	Economy and Taxation.....	12
3.5	Climate and Geography.....	12
3.6	Physiography.....	13
3.7	Seismic Zone and Risk.....	13
3.8	Demographics and Labour.....	13
3.9	Cultural Issues.....	14
3.10	Sovereign/Country Risk.....	15
3.11	Political / Legal / Judicial System.....	15
3.12	Mining Journal Investment Risk.....	16
4.	HISTORY.....	18
5.	GEOLOGICAL SETTINGS.....	20
5.1	Haib Deposit.....	22
5.2	Structural Controls on Copper Mineralisation.....	23
5.3	Mineralization.....	26
6.	DEPOSIT TYPES.....	28
7.	DRILLING.....	29
7.1	Historical Drilling Data.....	29

7.2	Core Recovery .....	29
8.	SAMPLE PREPARATION, ANALYSIS AND SECURITY .....	30
8.1	Sample Method and Approach.....	30
8.2	Sample Preparation, Analysis and Security .....	30
9.	DATA VERIFICATION.....	32
10.	MINERAL PROCESSING AND METALLURGICAL TESTING .....	33
10.1	Metallurgical Testwork.....	33
10.1.1	Introduction.....	33
10.1.2	Mineralogy .....	34
10.1.3	Prior Testwork .....	34
10.1.4	Metallurgical Studies and Process Optimisation .....	37
10.1.5	2019/2020 Metallurgical Testwork .....	37
11.	MINERAL RESOURCE .....	39
11.1	Introduction.....	39
11.2	Source Data .....	39
11.2.1	Drillhole Data.....	39
11.2.2	Three Dimensional Models.....	40
11.3	Domain Selection .....	41
11.4	Statistical Analysis.....	43
11.4.1	Univariate Statistics .....	43
11.4.2	Grade versus Sample Width .....	45
11.4.3	Compositing .....	46
11.4.4	Molybdenum – Analysed Grades versus Visual Estimates.....	48
11.5	Variography .....	49
11.5.1	Linear Semi-variograms .....	50
11.5.2	Omni-directional Semi-variograms.....	51
11.5.3	Directional Semi-variograms .....	52
11.6	Block Modelling .....	55
11.7	Density.....	56
11.8	Estimation.....	56
11.9	Estimate Validations .....	58
11.9.1	QQ Plots .....	59
11.9.2	Swath Plots .....	59
11.10	Mineral Resource Classification.....	60
11.11	Mineral Resources Statement.....	63
12.	MINING METHODS .....	65
12.1	Introduction.....	65
12.2	Geotechnical Review.....	65
12.2.1	Pit Slope Assessment .....	65
12.2.2	Excavation Characteristics .....	65
12.3	Groundwater Investigation .....	65
12.4	Proposed Mining Operation .....	65

12.4.1	Introduction .....	65
12.4.2	Open Pit Work Roster .....	66
12.4.3	Bench Design .....	66
12.4.4	Drill and Blast .....	66
12.4.5	Load and Haul .....	66
12.4.6	Stockpiling and Reclaiming .....	67
12.4.7	Pit Dewatering and Drainage .....	67
12.5	Contract Mining .....	67
12.6	Contract Drilling and Blasting .....	68
12.7	Pit Optimisation .....	68
12.7.1	Optimisation Methodology .....	68
12.7.2	Overall Pit Slopes .....	69
12.8	Mine Design .....	69
12.9	Tailing Disposal .....	69
12.9.1	Introduction .....	69
12.9.2	Environmental .....	69
12.10	Waste Rock Storage .....	70
12.10.1	Introduction .....	70
12.10.2	Waste Rock Storage Design .....	70
13.	<b>MINING SEQUENCE .....</b>	<b>71</b>
13.1	8.5 Mtpa Mining Sequence .....	72
13.2	20 Mtpa Mining Sequence .....	75
14.	<b>HEAP LEACHING BACKGROUND INFORMATION .....</b>	<b>79</b>
14.1	Primary Crushing .....	79
14.2	Secondary Crushing .....	80
14.3	Coarse Screening .....	81
14.4	Tertiary Crushing (HPGR) .....	83
14.5	Agglomeration .....	84
14.6	Percolation .....	85
14.7	Stacking .....	86
14.8	Bacterial Leaching .....	87
14.9	Aeration .....	88
14.10	Heap Leaching .....	89
14.11	Heap Leach Testwork .....	91
14.12	Pond Interconnections .....	92
14.13	Solvent Extraction .....	93
14.14	Electrowinning .....	94
14.15	PLC and SCADA Control .....	95
15.	<b>RECOVERY METHODS .....</b>	<b>96</b>
15.1	Ore Transport .....	97
15.2	Process Description .....	97
15.2.1	Crushing and Ore Handling - 8.5 Mtpa .....	97

15.2.2	Crushing and Ore Handling - 20 Mtpa .....	98
15.2.3	Agglomeration Drum .....	99
15.2.4	Heap Leach .....	99
15.2.5	PLS Clarification .....	100
15.2.6	Crud Treatment .....	100
15.2.7	Copper Solvent Extraction/Electrowinning .....	101
15.2.8	Iron and Aluminium Precipitation .....	102
15.2.9	Water Distribution .....	103
15.2.10	Reagents .....	103
15.2.11	Services .....	103
16.	PROJECT INFRASTRUCTURE .....	104
16.1	Mine Area Power Requirements .....	104
16.2	Mine Area Buildings .....	104
16.3	Explosives Storage .....	105
16.4	Waste Dumps .....	106
16.5	Power .....	106
16.5.1	Power in Namibia .....	106
16.5.2	Alternative Energy Sources .....	107
16.5.3	Future Outlook .....	108
16.5.4	Power Transmission Lines .....	109
16.5.5	Estimated Consumption .....	110
16.6	Water .....	111
16.7	Water Management Pond .....	112
16.7.1	Mine Site .....	112
16.7.2	Processing plant .....	112
16.8	Telecommunication .....	113
16.9	Workforce Accommodation .....	113
16.10	Workshop and Offices .....	113
16.11	Buildings .....	114
16.12	Roads .....	114
16.13	Air Services .....	115
16.14	Railways .....	115
16.15	Ports .....	116
17.	MARKET STUDIES & CONTRACTS .....	117
17.1	Copper .....	117
17.1.1	LME Copper .....	117
17.1.2	Copper Sulfate .....	117
18.	ENVIRONMENTAL, PERMITS, SOCIAL OR COMMUNITY IMPACT .....	119
18.1	Baseline Study .....	119
18.2	Environmental Management Plan .....	119
18.3	Project Environmental Assessment .....	120
18.4	Environmental Issues .....	120



18.4.1	Dust .....	120
18.4.2	Noise .....	121
18.4.3	Spillages .....	121
18.4.4	Contamination .....	121
18.4.5	Process Waste .....	122
18.4.6	Domestic/Municipal Waste .....	122
19.	OCCUPATIONAL HEALTH, HYGIENE AND SAFETY .....	123
20.	MANAGEMENT PLAN OBJECTIVES .....	124
21.	MANAGEMENT AND SAFETY ACCOUNTABILITY .....	125
21.1	Health, Safety and Environment Management .....	125
21.2	Management Responsibility and Accountability .....	125
21.3	On-site Manager/Supervisor .....	125
21.4	Personal Protective Equipment .....	126
21.5	Subcontractor Policy .....	127
21.6	General Hazards .....	127
21.7	Safety – General .....	129
21.8	Standard Operating Procedures and Training .....	129
21.9	Occupational Health and Hygiene .....	130
21.10	Injury Prevention and Rehabilitation .....	130
21.11	Medical Facility .....	131
21.12	Infectious Disease Management .....	131
21.13	Health Surveillance and Biological Monitoring .....	131
21.14	Noise Exposure .....	132
21.15	Dust Exposure .....	133
21.16	Fatigue Management .....	133
21.17	Fitness for Work .....	134
21.18	Vehicles and Machinery .....	134
21.19	Hazardous Materials .....	135
21.20	Electrical Safety .....	135
21.21	Energy Isolation .....	136
21.22	Cranes, Lifting Equipment and Working at Height .....	137
21.23	Cranes and Lifting Equipment .....	137
21.24	Work at Height .....	137
21.25	Personal Protective Equipment .....	138
21.26	Inspections and House-Keeping .....	138
22.	SOCIAL AND COMMUNITY MANAGEMENT .....	140
22.1	Community and Stakeholder Relations .....	140
22.2	Local Environment Consideration .....	140
23.	CAPITAL COST .....	142
23.1	Scope and Methodology .....	142
23.2	Basis of the Estimate .....	142
23.2.1	Direct Costs .....	142

23.2.2	Indirect Costs .....	146
23.3	Capital Cost – Option 1 (Base Case) .....	150
23.4	Capital Cost – Option 2 .....	151
23.5	Capital Cost – Option 3 .....	152
23.6	Capital Cost – Option 4 .....	153
23.7	Capital Cost – Option 5 .....	154
23.8	Capital Cost – Option 6 .....	155
23.9	Accuracy Assessment .....	156
24.	OPERATING COST .....	157
24.1	Scope and Methodology .....	157
24.2	Basis of Estimate .....	157
24.2.1	Estimated Labour Rates .....	157
24.2.2	Estimated Consumable Costs .....	157
24.2.3	Estimated Reagents Costs .....	157
24.2.4	Estimated Power Cost .....	158
24.2.5	Estimated Maintenance Cost .....	158
24.3	Cost Breakdown Structure .....	158
24.4	Operating Cost – Option 1 (Base Case) .....	165
24.5	Operating Cost – Option 2 .....	167
24.6	Operating Cost – Option 3 .....	169
24.7	Operating Cost – Option 4 .....	171
24.8	Operating Cost – Option 5 .....	173
24.9	Operating Cost – Option 6 .....	174
24.10	Accuracy Assessment .....	175
25.	ECONOMIC ANALYSIS .....	176
25.1	Introduction .....	176
25.2	Macro-Economic Assumptions .....	176
25.2.1	Metal Price Assumptions .....	176
25.2.2	Royalties .....	177
25.2.3	Taxes .....	177
25.2.4	Financing .....	177
25.2.5	Inflation .....	177
25.2.6	Mining Costs .....	177
25.2.7	Rail Freight .....	177
25.2.8	Wharfage and Ship Loading .....	177
25.2.9	Discount Rate .....	177
25.2.10	Exchange Rate .....	177
25.3	Technical Assumptions .....	177
25.4	Economic Outcomes – Option 1 (Base Case) .....	178
25.5	Economic Outcomes – Option 2 .....	184
25.6	Economic Outcomes – Option 3 .....	190
25.7	Economic Outcomes – Option 4 .....	196

25.8	Economic Outcomes – Option 5 .....	202
25.9	Economic Outcomes – Option 6 .....	208
25.10	Economic Opportunity .....	214
25.11	Project Viability .....	214
26.	RISK ASSESSMENT .....	215
26.1	Risks .....	215
26.2	Haib Risk Assessment Process .....	215
26.3	Establish the Context of the Review .....	216
26.4	Identify the Risks .....	216
26.5	Analyse the Risks .....	216
26.6	Prioritise the Risks .....	216
26.7	Haib Risk Table .....	216
26.8	Risks Identified .....	217
26.9	Opportunities .....	218
26.9.1	Solar Energy .....	218
26.9.2	Project Expansion .....	218
26.9.3	Optimisation .....	219
26.9.4	Sulfur Burning Plant .....	219
27.	PROJECT IMPLEMENTATION .....	220
27.1	Project Execution .....	220
27.1.1	Introduction .....	220
27.1.2	Project objectives .....	221
27.1.3	Construction .....	222
28.	WAY FORWARD .....	224
28.1	Feasibility Study .....	224
28.2	Feasibility Requirements .....	224
28.3	Resource Drilling .....	226
28.4	Metallurgical Testwork .....	226
28.4.1	Drill Core .....	226
28.4.2	Column Leach Tests .....	226
28.4.3	Variability Testwork .....	227
28.5	Engineering .....	227
28.6	Geology and Mining Study .....	227
28.7	Marketing Study .....	227
28.8	Environmental Assessments .....	228
29.	REFERENCES .....	229
	APPENDIX A – PROCESS DESIGN CRITERIA .....	230
	APPENDIX B – PROCESS FLOWSHEETS .....	287
	APPENDIX C – PROCESS DESCRIPTION .....	320
	APPENDIX D – MASS BALANCE .....	346
	APPENDIX E – MECHANICAL EQUIPMENT LIST AND CAPITAL COST .....	353
	APPENDIX F – OPERATING COST .....	382

## LIST OF TABLES

Table 1-1: Haib Comminution Data.....	3
Table 1-2: Capital Cost Summary.....	5
Table 1-3: Operating Cost Summary .....	6
Table 1-4: Economic summary .....	7
Table 10-1: Previous Haib Indicated Resource Figures .....	34
Table 10-2: Comminution Data .....	35
Table 11-1: Summary drilling statistics by drilling programme .....	39
Table 11-2: Listing Of Files Received From Teck.....	41
Table 11-3: Summary Univariate Statistics By Domain. ....	42
Table 11-4: Summary univariate statistics of the 10m composites by domain.....	47
Table 11-5: Derived omni-directional variogram models for copper and molybdenum by domain .....	52
Table 11-6: Derived variogram models and their associated anisotropy components for copper and molybdenum in the MZ and WR. ....	54
Table 11-7: Block model geometrical definitions .....	56
Table 11-8: Summary of the kriging inputs for each of the runs completed for copper and molybdenum in the MZ and the WR. ....	58
Table 11-9: Classified mineral resources.....	64
Table 13-1: Summary incremental schedule for the lower cut-off, waste balancing – 8.5 Mtpa .....	73
Table 13-2: Summary incremental schedule for the lower cut-off, waste balancing – 20 Mtpa .....	77
Table 16-1: Power requirement for each scenario.....	104
Table 16-2: Distances requirements (all in metres) to build a magazine for storage of explosives ...	106
Table 16-3 Power Demand Summary.....	111
Table 16-4: Building required at Haib project.....	114
Table 23-1: Power Supply Capital Cost .....	146
Table 23-2: Water supply capital cost.....	146
Table 24-1: Operating Cost Breakdown – Option 1 (Base Case).....	159
Table 24-2: Operating Cost Breakdown – Option 2.....	160
Table 24-3: Operating Cost Breakdown – Option 3.....	161

Table 24-4: Operating Cost Breakdown – Option 4 .....	162
Table 24-5: Operating Cost Breakdown – Option 5 .....	163
Table 24-6: Operating Cost Breakdown – Option 6 .....	164
Table 25-1: Assumed pricing data .....	176
Table 25-2: Option 1 - Project Metrics .....	178
Table 25-3: Option 2 - Project Metrics .....	184
Table 25-4: Option 3 - Project Metrics .....	190
Table 25-5: Option 4 - Project Metrics .....	196
Table 25-6: Option 5 - Project Metrics .....	202
Table 25-7: Option 6 - Project Metrics .....	208
Table 26-1: Subjective ranking matrix.....	216
Table 26-2: Risk register .....	218

## LIST OF FIGURES

Figure 1-1: Haib Copper Deposit Location.....	2
Figure 3-1: Investment risk index.....	17
Figure 5-1: General distribution of the Vioolsdrift and Orange River rocks .....	20
Figure 5-2: Geology of Haib (from Teck 2015) .....	21
Figure 5-3: Intrusive rock units of the Haib deposit (Source: Teck 2015).....	22
Figure 5-4: Tectonic sub-division of the Namaqua sector of the Namaqua-Natal Province .....	23
Figure 5-5: Map of the three main structures at Haib .....	24
Figure 5-6: North-south cross-section across the western end of Haib.....	25
Figure 5-7: Haib deposit anomaly map .....	26
Figure 11-1: Plan showing the limits of geological modelling conducted by Teck with the available drilling overlaid .....	40
Figure 11-2: Isometric view showing the various 3D models received from Teck.....	41
Figure 11-3: Isometric view showing the Haib mineral resource model with a contained higher grade Main Zone (MZ) and surrounding Wall Rocks (WR).....	43
Figure 11-4: Normal and log-histograms of the distribution of Cu within the MZ along with the associated summary statistics. ....	44
Figure 11-5: Normal and log-histograms of the distribution of Cu within the WR along with the associated summary statistics. ....	45

Figure 11-6: Scatterplots for all raw samples comparing copper and molybdenum grade to sample width.....	46
Figure 11-7: Normal histograms showing the distribution of the 10m composite copper and molybdenum grades within the MZ and WR.....	47
Figure 11-8: QQ Plots comparing by the domain, the copper and molybdenum grade distributions of the raw data against the derived 10m composites. ....	48
Figure 11-9: Cumulative frequency curves comparing the grade distributions of analysed molybdenum grades and visual estimates.....	49
Figure 11-10: Experimental linear semi-variograms for copper and molybdenum and the derived spherical models. ....	51
Figure 11-11: Directional semi-variograms showing the “All Orientations” variogram models for copper and molybdenum in the MZ and WR. ....	53
Figure 11-12: Isometric views showing the selected variogram anisotropy relative to the 3D models, MZ for copper and the molybdenum isoshell for molybdenum .....	55
Figure 11-13: Isometric views showing the selected variogram anisotropy relative to the 3D models, MZ for copper and the molybdenum isoshell for molybdenum.....	59
Figure 11-14: Swath plots showing horizontal trends in source 10m composites and the estimates of copper. ....	60
Figure 11-15: Vertical section looking westwards showing the mineral resource classification of the MZ along with sample positions.....	62
Figure 11-16: Vertical section looking westwards showing the mineral resource classification of the WR along with sample positions.....	63
Figure 11-17: Copper grade/tonnage curves for the MZ and WR. ....	64
Figure 13-1: Plan showing the polygons used to compile the mining schedule .....	72
Figure 13-2: Mining sequence – 8.5 Mtpa .....	74
Figure 13-3: Ore (red) and waste (blue) mining by period – 20 Mtpa.....	76
Figure 13-4: Mining sequence – 20 Mtpa .....	78
Figure 14-1: Primary crusher schematic .....	79
Figure 14-2: Secondary crusher schematic .....	81
Figure 14-3: Typical secondary screen.....	82
Figure 14-4: Typical HPGR schematic.....	83
Figure 14-5: Agglomeration drum .....	84
Figure 14-6: Agglomeration drum .....	85
Figure 14-7: Un-agglomerated ore with clay.....	86
Figure 14-8: Grasshopper conveyors and stacker.....	86

Figure 14-9: Grasshopper conveyors and stacker.....	87
Figure 14-10: Requirement for aeration of heap leaching .....	88
Figure 14-11: Heap leach flowsheet .....	90
Figure 14-12: Ore on pad with solution flowing to toe drain .....	91
Figure 14-13: Typical leach pad general arrangement.....	91
Figure 14-14: Pond Interconnection.....	93
Figure 14-15: Solvent extraction process .....	94
Figure 14-16: Electrowinning process.....	94
Figure 16-1: Mine site layout.....	105
Figure 16-2 Geographical Location of the Caprivi Link Interconnector .....	109
Figure 16-3: Power Line Transmission and Substations in the South of Namibia.....	110
Figure 16-4: Roads close to Haib project. Source Google Maps, 2017 .....	115
Figure 16-5: Railway network nearby to Haib deposit showing the ports of Luderitz and Walvis bay. .....	116
Figure 25-1: Option 1 NPV and Sensitivity Results .....	179
Figure 25-2: Option 2 NPV and Sensitivity Results .....	185
Figure 25-3: Option 3 NPV and Sensitivity Results .....	191
Figure 25-4: Option 4 NPV and Sensitivity Results .....	197
Figure 25-5: Option 5 NPV and Sensitivity Results .....	203
Figure 25-6: Option 6 NPV and Sensitivity Results .....	209

## **1. EXECUTIVE SUMMARY**

### **1.1 Introduction**

METS Engineering has carried out a Preliminary Economic Assessment (PEA) Update of the Haib Project located in Southern Namibia. The PEA update was carried out to incorporate the results from the Mintek testwork program (2019/2020) and is based on the PEA report completed by METS in February, 2018. This report presents the findings of the PEA update undertaken for the proposed development of the Haib Project, with a view that aims to maximise the positive aspects of the project and to minimise or manage any negative implications and risks. It is focussed only on the whole ore heap leaching process route.

### **1.2 Location**

The Haib copper deposit is in the extreme south of Namibia close to the border with South Africa, which is defined by the course of the Orange River (Figure 1-1). The deposit lies some 12-15 kilometres east of the main tarred interstate highway connecting South Africa and Namibia and the nearest railway station is at Grunau, which is approximately 120km north on the main highway. This rail connection could provide access to either the port of Luderitz or to Walvis Bay via Windhoek. Noordoewer is the closest town, which is located on the Orange River banks approximately 25 km west of the Haib deposit.





Figure 1-1: Haib Copper Deposit Location

### 1.3 Geology and Mineralisation

The Haib deposit is located within part of the Namaqua-Natal Province called the Richtersveld geological sub-province which is further subdivided into a volcano-sedimentary sequence (locally, the Haib Subgroup), the Orange River Group and the intrusive Vioolsdrift suite which are closely related in space and time. The principal mineralised hosts at the Haib are a Quartz Feldspar Porphyry (QFP) and a Feldspar Porphyry (FP).

The Haib deposit is in essence a very large volume of rock containing copper mineralization. The grade is variable from higher grade in the three core zones (possibly averaging >0.4%) progressively dropping towards the margin of the deposit. The principal sulfides within the Haib body are pyrite and chalcopyrite with minor molybdenite, bornite, digenite, chalcocite and covellite.

### 1.4 Exploration/Drilling

The deposit has a distinct surface expression with abundant copper staining on fractures and joint planes particularly in and around the dry river bed of the Volstruis River. This led to German prospectors identifying the deposit around the late 1800s or early 1900s. Since then several drilling programs have been conducted by several companies including Falconbridge, King Resources, Rio Tinto, Revere Resources and Great Fitzroy Mines NL.

## 1.5 Mineral Processing and Metallurgical Testing

Basic testwork were conducted on the Haib deposit including:

- Comminution
- Heavy Liquid Separation (HLS)
- Bio-Heap Amenability
- Flotation
- Ore Sorting
- Geotechnical

The results from the original comminution testwork produced by Minproc in the 1997 Feasibility Study based on grinding and flotation is seen in Table 1-1.

**Table 1-1: Haib Comminution Data**

<b>Comminution Data</b>	
Head Grade	0.31% Cu
In-Situ Density	2.6 t/m <sup>3</sup>
Specific Gravity	2.7
Ore Density	1.8 t/m <sup>3</sup>
Crushing Work Index (CWi)	22.3 kWh/t
Unconfined Compressive Strength (UCS)	150 MPa
Abrasion Index (Ai)	0.485
Angle of Repose	36°
Angle of Reclaim	55°
Ball Mill Work Index (BWi)	18.0 kWh/t
Rod Mill Work Index (RWi)	21.6 kWh/t

## 1.6 Mining Methods

Considering the Haib copper deposit characteristics, the suitable mine design is based on an open pit mining method. As the deposit is basically composed by low grade hard rock material, the mining operations will involve drill and blast of all excavated material, which will be grade controlled by cut-off grade.

## 1.7 Metallurgical Testwork

The Mintek metallurgical testwork used as the basis for this PEA update is reported separately as shown in the Appendices. This will be issued as a separate report.

## 1.8 Recovery Methods

For the recovery of copper from the Haib deposit, heap leaching was considered. The primary reasons for the selection of heap leaching is the low grade nature of the deposit and the vast size of the orebody. Previous work conducted on the Haib project suggests that a conventional crush-grind-float and sale of copper concentrate is not economically feasible due to the low grade and hardness of the ore – requiring a significant amount of energy for grinding. The low costs associated with heap leaching compared to a whole ore flotation circuit is believed to improve the viability of the project. Heap leaching is traditionally performed on oxide material, although there has been increasing development in the application to acid insoluble sulfides. Previous sighter amenability testwork suggests the Haib material can extract high amounts of copper, up to 95.2% via a bacterial assisted leaching, although additional testwork is required to determine the optimal operating parameters. Given these results there is no reason to suggest the chalcopyrite in the Haib deposit will not be amenable to bacterial assisted heap leaching.

Column leach testwork has been ongoing at Mintek in South Africa during 2019/2020. Mintek has significant expertise and a long history of bacterial leaching of copper sulfide ores. Six options were established for whole ore heap leaching at different copper recoveries, different final products (copper cathode and copper sulfate) and copper prices for the purposed of the economic evaluation:

- Option 1: 8.5 Mtpa with 80% copper recovery with  $\text{CuSO}_4$  (base case)
- Option 2: 8.5 Mtpa with 85% copper recovery
- Option 3: 8.5 Mtpa with 85% copper recovery with  $\text{CuSO}_4$
- Option 4: 20 Mtpa with 80% copper recovery with  $\text{CuSO}_4$
- Option 5: 20 Mtpa with 85% copper recovery
- Option 6: 20 Mtpa with 85% copper recovery with  $\text{CuSO}_4$

## 1.9 Marketing

Copper is the main product that will be obtained from the process which will exist in the form of chalcopryrite or chalcocite concentrate from flotation, copper metal from electrowinning and copper sulfate from crystallisation.

Copper is one of the most widely used metals on the planet. China, Europe and the USA are the main global consumers of copper. Copper will be produced on the cathode of the electrowinning cell as pure LME cathode sheets which will be a pure (99%) solid. Pure copper metal is used for a variety of purposes with the major purpose being electrical wiring due to its great electrical conductivity.

Copper sulfate will be sold as a blue powder when the crystals are crushed and dried. Copper sulfate is used in multiple industries such as arts, mining, chemical, pharmaceutical, healthcare and agricultural fertiliser. The biggest use is for farming as an herbicide or fungicide as it can be used to control fungus on grapes, melons and berries. High purity copper sulfate has a 25% premium price based on the copper content in the sulfate.

## 1.10 Environmental and Permitting

A future environmental study will be required to assess:

- Baseline study
- Environmental management plan
- Project environmental assessment
- Environmental issues (dust, noise etc.)

## 1.11 Capital and Operating Costs

In summary, the capital and operating costs for the six options assessed are summarised in Table 1-2 and Table 1-3.

**Table 1-2: Capital Cost Summary**

Cost	Option 1	Option 2	Option 3	Option 4	Option 5	Option 6
Direct, US\$	\$141,490,330	\$143,394,330	\$142,300,580	\$246,625,080	\$245,765,830	\$247,074,830
Indirect, US\$	\$54,062,486	\$54,788,726	\$54,371,539	\$94,163,884	\$93,836,141	\$94,335,431
<b>Total, US\$</b>	<b>\$195,552,816</b>	<b>\$198,183,056</b>	<b>\$196,672,119</b>	<b>\$340,788,964</b>	<b>\$339,601,971</b>	<b>\$341,410,261</b>

**Table 1-3: Operating Cost Summary**

Area		Option 1	Option 2	Option 3	Option 4	Option 5	Option 6
Mining		0.36	0.40	0.35	0.40	0.40	0.38
Processing		0.93	0.91	0.92	0.80	0.77	0.79
Product Freight		0.05	0.02	0.05	0.03	0.02	0.03
Wharfage and Shiploading		0.01	0.002	0.005	0.004	0.002	0.004
Administration		0.03	0.04	0.03	0.04	0.04	0.03
Royalty	\$2.00	0.06	0.07	0.06	0.06	0.06	0.06
	\$2.25	0.07	0.08	0.07	0.07	0.07	0.07
	\$2.50	0.08	0.09	0.08	0.08	0.08	0.08
	\$2.85	0.09	0.09	0.09	0.09	0.09	0.09
	\$3.00	0.09	0.09	0.09	0.09	0.09	0.09
	\$3.25	0.10	0.10	0.10	0.10	0.10	0.10
	\$3.50	0.11	0.11	0.11	0.11	0.11	0.11
	\$3.75	0.11	0.11	0.11	0.11	0.11	0.11
	\$4.00	0.12	0.12	0.12	0.12	0.12	0.12
<b>Total (US\$/lb Cu Eq)</b>	\$2.00	<b>1.44</b>	<b>1.43</b>	<b>1.41</b>	<b>1.33</b>	<b>1.29</b>	<b>1.30</b>
	\$2.25	<b>1.45</b>	<b>1.43</b>	<b>1.41</b>	<b>1.34</b>	<b>1.30</b>	<b>1.31</b>
	\$2.50	<b>1.45</b>	<b>1.44</b>	<b>1.42</b>	<b>1.34</b>	<b>1.31</b>	<b>1.32</b>
	\$2.85	<b>1.46</b>	<b>1.45</b>	<b>1.43</b>	<b>1.35</b>	<b>1.32</b>	<b>1.33</b>
	\$3.00	<b>1.47</b>	<b>1.46</b>	<b>1.44</b>	<b>1.36</b>	<b>1.32</b>	<b>1.33</b>
	\$3.25	<b>1.48</b>	<b>1.46</b>	<b>1.44</b>	<b>1.37</b>	<b>1.33</b>	<b>1.34</b>
	\$3.50	<b>1.48</b>	<b>1.47</b>	<b>1.45</b>	<b>1.37</b>	<b>1.34</b>	<b>1.35</b>
	\$3.75	<b>1.49</b>	<b>1.48</b>	<b>1.46</b>	<b>1.38</b>	<b>1.35</b>	<b>1.35</b>
	\$4.00	<b>1.50</b>	<b>1.49</b>	<b>1.47</b>	<b>1.39</b>	<b>1.35</b>	<b>1.36</b>

**Option Descriptions:**

- Option 1: 8.5 Mtpa with 80% copper recovery with CuSO<sub>4</sub> (base case)
- Option 2: 8.5 Mtpa with 85% copper recovery
- Option 3: 8.5 Mtpa with 85% copper recovery with CuSO<sub>4</sub>
- Option 4: 20 Mtpa with 80% copper recovery with CuSO<sub>4</sub>
- Option 5: 20 Mtpa with 85% copper recovery
- Option 6: 20 Mtpa with 85% copper recovery with CuSO<sub>4</sub>

## 1.12 Economic Analysis

Based on the economic analysis, Option 6 – 20 Mtpa at a copper recovery of 85% producing both LME copper and copper sulfate produces the most favourable NPV and IRR. The summary for each scenario is presented in Table 1-4.

**Table 1-4: Economic summary**

Scenario	Option 1										Option 2								
Pre-Production CAPEX (US\$M)	\$196										\$198								
Total Operating Expense (US\$/lb Cu Eq)	\$0.93										\$0.906								
Copper Price, US\$/lb	\$2.00	\$2.25	\$2.50	\$2.85	\$3.00	\$3.25	\$3.50	\$3.75	\$4.00	\$2.00	\$2.25	\$2.50	\$2.85	\$3.00	\$3.25	\$3.50	\$3.75	\$4.00	
NPV <sub>7.5%, pre-tax</sub> (US\$ M)	\$165	\$321	\$477	\$695	\$788	\$944	\$1,100	\$1,256	\$1,411	\$136	\$277	\$418	\$616	\$701	\$842	\$983	\$1,124	\$1,266	
IRR <sub>7.5%, pre-tax</sub> (%)	13.4%	18.5%	23.2%	29.4%	32.0%	36.1%	40.0%	43.8%	47.5%	12.4%	17.0%	21.3%	27.0%	29.3%	33.1%	36.7%	40.3%	43.7%	
Payback Period (years)	9.97	7.11	5.58	4.34	3.97	3.5	3.1	2.9	2.6	10.86	7.78	6.12	4.75	4.35	3.8	3.4	3.1	2.9	
Scenario	Option 3										Option 4								
Pre-Production CAPEX (US\$ M)	\$197										\$341								
Total Operating Expense (US\$/lb Cu Eq)	\$0.92										\$0.80								
Copper Price, US\$/lb	\$2.00	\$2.25	\$2.50	\$2.85	\$3.00	\$3.25	\$3.50	\$3.75	\$4.00	\$2.00	\$2.25	\$2.50	\$2.85	\$3.00	\$3.25	\$3.50	\$3.75	\$4.00	
NPV <sub>7.5%, pre-tax</sub> (US\$ M)	\$205	\$369	\$533	\$763	\$861	\$1,025	\$1,189	\$1,353	\$1,517	\$424	\$701	\$977	\$1,364	\$1,530	\$1,807	\$2,083	\$2,360	\$2,636	
IRR <sub>7.5%, pre-tax</sub> (%)	14.7%	19.9%	24.8%	31.1%	33.8%	38.0%	42.1%	46.0%	49.8%	18.6%	24.6%	30.1%	37.3%	40.2%	44.9%	49.4%	53.8%	58.1%	
Payback Period (years)	9.05	6.57	5.21	4.08	3.75	3.3	3.0	2.7	2.5	6.91	5.21	4.22	3.38	3.13	2.8	2.5	2.3	2.2	
Scenario	Option 5										Option 6								
Pre-Production CAPEX (US\$ M)	\$340										\$341								
Total Operating Expense (US\$/lb Cu Eq)	\$0.77										\$0.79								
Copper Price, US\$/lb	\$2.00	\$2.25	\$2.50	\$2.85	\$3.00	\$3.25	\$3.50	\$3.75	\$4.00	\$2.00	\$2.25	\$2.50	\$2.85	\$3.00	\$3.25	\$3.50	\$3.75	\$4.00	
NPV <sub>7.5%, pre-tax</sub> (US\$ M)	\$459	\$733	\$1,006	\$1,390	\$1,554	\$1,828	\$2,101	\$2,375	\$2,649	\$503	\$796	\$1,088	\$1,498	\$1,673	\$1,966	\$2,259	\$2,551	\$2,844	
IRR <sub>7.5%, pre-tax</sub> (%)	19.4%	25.3%	30.7%	37.8%	40.7%	45.3%	49.8%	54.2%	58.4%	20.4%	26.5%	32.2%	39.6%	42.6%	47.5%	52.2%	56.7%	61.1%	
Payback Period (years)	6.63	5.06	4.14	3.33	3.09	2.8	2.5	2.3	2.1	6.32	4.83	3.94	3.18	2.94	2.6	2.4	2.2	2.0	

### 1.13 Recommendations

The results from the Preliminary Economic Assessment have been very promising and we now have results from laboratory column leach tests undertaken at Mintek confirming copper recovery and amenability of the Haib ore to heap leaching. Going forward METS recommend Deep-South Resources move to conduct a Feasibility Study (FS) as the next phase of the project.

To improve confidence in the FS results, more detailed metallurgical testwork will be required. Most work to date has focussed on the potential of processing options and was performed on high grade copper ore and is not sufficient and representative enough to truly evaluate their feasibility with confidence on the lower grade ore in the deposit.

We have set ourselves a target of achieving 85% copper recovery as a basis of design. Some of the parameters we will evaluate in the future are:

- Fully recycled column and not single pass
- Operate at a higher temperature
- Finer crush size
- Different bacterial strains
- Resting after 200 days for 30 days and then irrigation for another 30 days
- Adjust pH for an ideal range for the bacteria. pH
- Additional nutrients

In this regard we have Mintek, CSIRO in Perth as well as Professor Sue Harrison at the university of Cape Town with centres of excellence in bacterial leaching of ores and minerals.

Further drilling of the deposit to map out higher grade zones which can be included in the early part of the mine schedule is recommended. This will improve project economics in the financial model.

Post the Feasibility Study and drilling of the ore body above a small Pilot Plant is recommended on site to validate and optimise the process under local conditions. The detailed engineering information and optimisation would provide improved confidence in proceeding with a commercial operation.

The work conducted to date provides confidence to move forward and there is every possibility of improving copper recovery and reducing the operating costs further.

## **2. INTRODUCTION**

### **2.1 Purpose**

The purpose of this technical report is to present the results of the update of the 2018 Preliminary Economic Assessment for the Deep-South Resources Haib Project to incorporate the results from the current testwork programme. This report assess Option 4 of the 2018 PEA; a straight heap leach to identify the economic viability of whole ore leaching with different throughputs, copper recovery and copper pricing. Additionally, this report gives recommendations on further work to enhance the accuracy and viability of the project. This technical report supersedes any previous reports provided by METS engineering although sections of those reports have been reproduced here from the original.

### **2.2 Sources of Information**

In order to prepare the content of the report, the authors worked closely with, and received information from, Mr Pierre Leveille, Deep-South Resources CEO and Mr. Vivian Stuart-Williams, Deep-South Resources Vice President, Exploration. Mr Leveille and Mr Stuart-Williams provided assistance with the mineral resource statements with updated reserve estimates, water costs and labour costs.

The information, conclusions, opinions and estimates contained herein are based on:

- Data, geological reports, maps, documents, technical reports and other information provided by Deep-South Resources.
- Field observations of the site based on past METS site visits to Namibia.
- Past reports in the METS database
- Past Haib studies on the METS database
- A column leach testwork program undertaken at Mintek

### **2.3 Site Visit**

Peter Walker visited the Haib Project site described in this report on various occasions between 1989 and 1995 and on the 24th January 2012 in the company of Mr. Nuri Ceyhan, exploration manager of Teck Namibia and with Mr. Neil Grumbley, Teck's Haib Project manager and again on the 30th June 2015 with Mr. Neil Grumbley. Peter is assured by the HM management that as at the date of this report no further field work or material change



has occurred at the Haib project site since my June 2015 visit and that only desk-top appraisal studies as outlined in this report have been concluded since that visit.

Damian Connelly visited the Haib site in 2006. The objective of the site visit was to assess the surrounding infrastructure, view drill core samples and obtain a general feel for the site. No site visit was undertaken for the PEA.

Dean Rachardd of Obsidian Consulting and Vivian Stuart-Williams from Deep-South visited the Haib site at the end of January 2020. The objective of the site visit was to collect information to understand the geology and mineralisation of the Haib deposit.

## **2.4 References**

- Haib Copper Project 2018 Preliminary Economic Assessment Report
- METS Database
- Equipment and Reagent Vendors
- Namibian Government Websites
- Google Maps

### **3. COUNTRY AND REGIONAL SETTINGS**

#### **3.1 General**

Namibia in South-West Africa is one of the driest and most sparsely populated countries on Earth. It is bounded by the South Atlantic Ocean on the west, Angola to the north, Botswana to the east and South Africa to the south. The Caprivi Strip, a narrow extension of land in the extreme north-east connects it to Zambia.

Namibia comprises thirteen regions (from south to north): Karas, Hardap, Khomas, Erongo, Omaheke, Otjozondjupa, Kunene, Oshikoto, Okavango, Omusati, Oshana, Caprivi and Ohangwena.

The Haib Copper deposit is located in Karas, which is the least densely populated of the thirteen regions of Namibia. The region is a predominantly small stock farming area, consisting mostly of animals such as sheep or goats. Game farming and crop farming along the Naute Dam and the Orange River are of significant importance to the region.

#### **3.2 Accessibility**

Access to the Haib deposit is via a 10 km graded gravel road from the main interstate tarred highway to the old Rio Tinto Zinc Corporation (RTZ) exploration campsite. This road is accessible to conventional cars. From the RTZ campsite to the Haib copper deposit (another 5 km) is a four wheel drive gravel track that is relatively slow but essentially all-weather. The site itself is very rugged and there is only limited access along the numerous bulldozed roads. Access around the site is largely by foot. A further analysis will have to be made on the accessibility of the site.

#### **3.3 Local Resources and Infrastructure**

There is reasonable infrastructure surrounding Haib to support the proposed project. The Haib deposit is relatively close to the main international tar road so the only construction required would be an upgrade of the graded access road to the RTZ campsite, with a minor deviation to the proposed process plant site and the construction of a suitable road for mine site access. The main north-south national power grid lies some 85km to the east of the Haib. An 85 km link would likely be required should the project develop. Water is expected to be available from the Orange River (about 15 km by pipeline south of the Haib deposit). The nearest rail link is located at Grunau, approximately 120 km north of the deposit. The area between the Haib and Grunau is almost completely flat and the local rail authority has

confirmed that a link could be laid relatively easily. Suitable areas for heap leach pads and waste rock dumps are available dependant on eventual plant design. The nearest town of Noordoewer is some 20 km by road to the southwest of Haib on the Orange River.

### **3.4 Economy and Taxation**

The country's sophisticated formal economy is based on capital-intensive industry and farming. However, Namibia's economy is heavily dependent on the earnings generated from primary commodity exports in a few vital sectors, including minerals, especially diamonds, livestock and fish, which make Namibia's economy completely vulnerable to world commodity price fluctuations. Mining accounts for 11.5% of Gross Domestic Product (GDP), but provides more than 50% of foreign exchange earnings. Rich alluvial diamond deposits make Namibia a primary source for gem-quality diamonds.

Namibia is the world's fourth-largest producer of uranium due to the Chinese Husab uranium mine, which commenced production in 2016. Namibia also produces large quantities of zinc and is a smaller producer of gold and copper. The mining and quarrying sectors employ 2% of the population.

Namibia normally imports about 50% of its cereal requirements; in drought years food shortages can be a problem in rural areas. A high per capita GDP, relative to the region, hides one of the world's most unequal income distributions. A priority of the current government is poverty eradication.

In terms of taxation, Namibia has a source-based tax system, which means that income from a source within Namibia or deemed to be within Namibia will be subject to tax in Namibia, unless a specific exemption is available. For non-diamond miners, the taxation rate is set to 37.5%

### **3.5 Climate and Geography**

With an average of 300 days of sunshine annually, Namibia is one of the sunniest countries in the world. In general, Namibia's climate can be described as hot and dry, substantial fluctuations during the seasons or even within one day are typical. The different regions show considerable climatic differences regarding precipitation and temperature though. The amount of precipitation increases from the southwest to the northeast from an annual 0 mm to a maximum of 600 mm.

The Haib copper deposit is in the extreme south of Namibia and is unusual in that it is located on the boundary between the summer and winter rainfall areas. In summer the temperature can go as high as the mid 40°C, while in winter it can go as low as freezing

point. Rainfall in winter is generally light drizzle with occasional harder falls. In summer the rainfall is associated with occasional thunder storms and is of short duration, but can be of very high intensity. All of the streams within the area are ephemeral and can flow very strongly after summer rainfall. Average annual rainfall is 25-50 mm. Access to site is possible throughout the year.

### **3.6 Physiography**

The Haib deposit straddles the Volstruis River (meaning the ostrich river in Afrikaans), which is a tributary of the Haib River. Both are ephemeral tributaries of the Orange River which lies south of Haib. The Orange River is a deeply incised drainage with several nick-points. Haib lies below all of the main nick-points at a location where the Orange River elevation is approximately 200 metres above sea level (ASL). The Haib deposit lies at elevations from a floor elevation of just under 375 metres ASL to over 600 metres ASL. The surrounding area is up to about 650 m ASL at the highest point. The area is rugged with steep sided valleys and rapid local relief.

### **3.7 Seismic Zone and Risk**

Namibia rests in the middle of a tectonic plate on a passive continental margin, called the African Plate, and has little earthquake activities and no volcanism. According to the website <https://earthquakes.zone/namibia>, in the last 35 years, Namibia was hit by 13 earthquakes with magnitudes between 4.1-5.3. The closest earthquake epicenter from the Haib copper deposit was in 1993, located in Warmbad, with magnitude of 4.3.

### **3.8 Demographics and Labour**

According to the 2019 revision of the World Population Prospects the total Namibian population was 2,495,000, compared to only 485,000 in 1950. The proportion of children below the age of 15 in 2019 was 36.9%, 59.5% was between 15 and 65 years of age while 3.6% was 65 years or older. The majority of Namibians are rural dwellers (about 55%) and live in the better-watered north and northeast parts of the country. According to the Namibia Labour Force Survey 2018 Report, the Namibia labour force has 1,090,153 people, and those who work in the mining and quarrying industry represent only 1.1% (12,087 labours).

Migration; historically male-dominated, generally flows from northern communal areas – non-agricultural lands where blacks were sequestered under the apartheid system – to agricultural, mining, and manufacturing centres in the centre and south.

Regarding the Haib deposit area, the nearest settlement is Noordoewer, around 12 km south of the Haib entrance gate, a village of some 5,000 people with only basic services and facilities. Noordoewer is known for grape production and tourism (canoeing) and is an important border post on a crucial transport route between Namibia and South Africa.

### **3.9 Cultural Issues**

Unemployment - Despite the abundance of natural resources, the Republic of Namibia remains one of the poorest countries in all of Africa. About 56% of Namibia's population live below the poverty line (live on less than \$2 a day with the majority living on less than \$1.25 a day) and about 43% of Namibians remain unemployed.

AIDS - The most serious health problem in Namibia is the high incidence of AIDS, which was first recorded in 1986 when four people were diagnosed HIV positive. Namibia has reached pandemic proportions with incidence rates in Africa higher than any other continent and since 1996 AIDS has become the number one cause of death in Namibia.

Water Supply - Namibia is an arid country that is regularly afflicted by droughts. Large rivers flow only along its Northern and Southern border, but they are far from the population centres. In order to confront this challenge the country has built dams to capture the flow from ephemeral rivers, constructed pipelines to transport water over large distances, pioneered potable water reuse in its capital Windhoek located in the central part of Namibia, and built Sub-Saharan Africa's first large seawater desalination plant to supply a uranium mine and the city of Swakopmund with water.

Food Supply - Namibia produces about 40% of the food it consumes and is highly dependent on imports. This means that while food is available, price fluctuations can make it difficult to access for 26% of Namibian families. This particularly affects the 80% of the population who depend on markets to fulfil their food needs. Smallholder farmers also have limited access to nutritious food due to recurrent droughts and floods, low productivity and access to land issues. These limitations translate into poorly diversified diets with insufficient consumption of vitamins and minerals, which are at the root of persistent malnutrition.

Namibian food imports include various categories of vegetables, potatoes, tomatoes, apples, tea, spices, seed of wheat, maize, roasted malt, sunflower seed and oil, margarine, prepared foods, bulgar wheat, sweet biscuits, all types of juices, water and other non-alcoholic beverages. Looking at the figures from 2004 to 2014, in 2004 the value of food imports was around US\$114 million. This rose to about AU\$253 million in 2010 and in 2014 this had risen to around AU\$688 million.

In contrast, the clean, cold South Atlantic waters off the coast of Namibia are home to some of the richest fishing grounds in the world, with the potential for sustainable yields of 1.5 million metric tonnes per year. Commercial fishing and fish processing is the fastest-growing sector of the Namibian economy in terms of employment, export earnings, and contribution to GDP.

### **3.10 Sovereign/Country Risk**

In 1990, Namibia became an independent nation. Since then, it has enjoyed relative stability. Companies face a moderate risk of corruption in Namibia. While the country suffers from less corruption compared to other countries in the region, corruption remains common. The country's public procurement sector is particularly susceptible to corruption due to the monopoly of state-owned companies (parastatals).

In terms of security, even though Namibia has a high rate of domestic violence, particularly against women and children, there is no risk of civil war and the last war was the Namibia War of Independence, in 1990.

### **3.11 Political / Legal / Judicial System**

*Politics of Namibia* takes place in a framework of a presidential representative democratic republic, whereby the President of Namibia is both head of state and head of government, and of a pluriform multi-party system. Executive power is exercised by the government. Legislative power is vested in both the government and the two chambers of parliament. The Judiciary is independent of the executive and the legislature.

According to Namibia's constitution, elected by direct universal adult suffrage at intervals of not more than five years, the President must receive more than 50 per cent of the votes cast. He or she appoints the government, the armed forces chief of staff and members of a Public Service Commission, but the National Assembly may revoke any appointment. The President can only serve two successive directly elected five-year terms. The President may dissolve the National Assembly, and may also proclaim a state of national emergency and rule by decree, subject to the approval of the National Assembly.

*The judiciary of Namibia* consists of a three-tiered set of courts: the Lower, High and Supreme Courts.

- *The Lower Courts* are established by an act of Parliament and are bound by the four corners of legislation. There are several lower courts in Namibia. They are the magistrates' courts, the (labour) arbitration tribunals and the customary courts.

- *The High Court* exercises original jurisdiction. It can act both as a court of appeal and a court of first instance over civil and criminal prosecutions and in cases concerning the interpretation, implementation and preservation of the Constitution. The High Court is presided over by the Judge-President. A full sitting of the High Court consists of the Judge-President and 6 other judges. Its jurisdiction with regard to appeals shall be determined by Acts of Parliament. Decisions of the High Court, which bind lower courts, are recorded both in Namibian and South African law reports. The decisions are recorded and summarized in the same way as Supreme Court decisions.
- *The Supreme Court* is the highest national forum of appeal. It has inherent jurisdiction over all legal matters in Namibia. It adjudicates, according to article 79 of the Constitution, appeals emanating from the High Court, including appeals which involve the interpretation, implementation and upholding of the Constitution and the fundamental rights and freedoms guaranteed therein.

### **3.12 Mining Journal Investment Risk**

Based on Mining Journal 2017 World Risk report, Namibia sits mid-range of regions to invest in (see Figure 3-1). Saskatchewan is the best and Guinea is the worst.

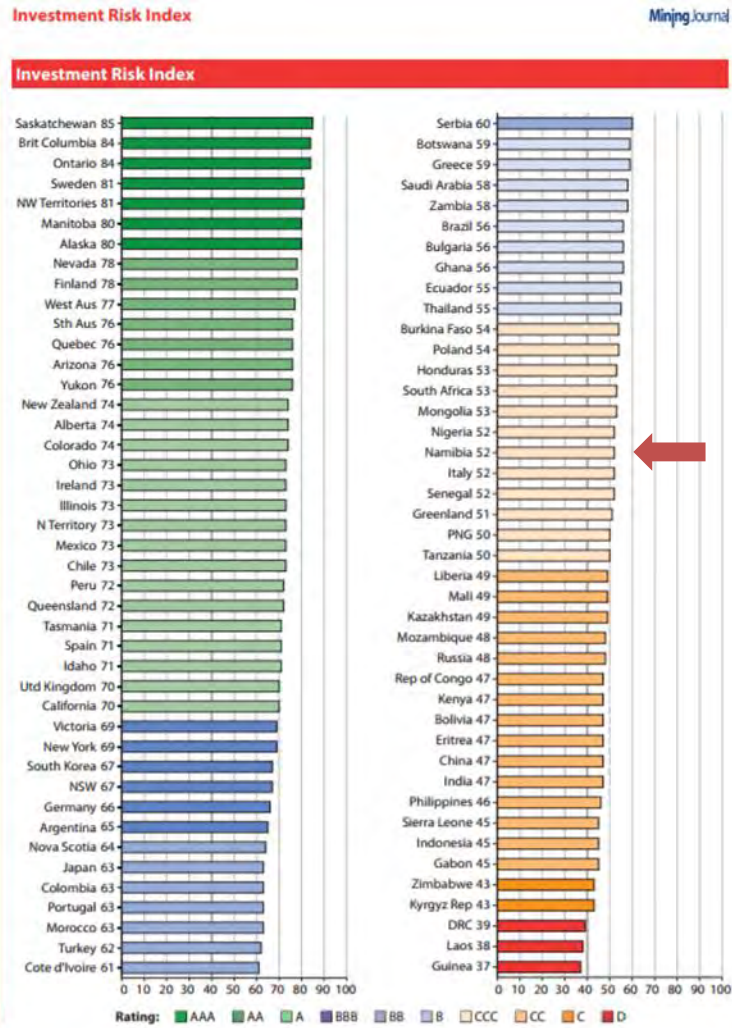

10 WORLD RISK REPORT feat. MinedHuttre ratings

2017 edition

**Figure 3-1: Investment risk index**



#### 4. HISTORY

*Early Mining* -The deposit has a distinct surface expression with abundant copper staining on fractures and joint planes particularly in and around the dry river bed of the Volstruis River. This led to German prospectors identifying the deposit around the late 1800s or early 1900s. Small tonnages of high grade copper carbonate ore were mined at this time. The word Haib is probably from a local language although the HaibPforte (fort) is shown on the original German military maps of German West Africa, dating from about 1907. The fort appears to have been a place rather than a structure and the location on the ground is unknown.

After World War II, the prospect owner George Swanson carried out small scale mining and tank leaching operations. Copper carbonate ore was leached with acid. The acid was then run over iron scrap and the copper precipitated as “copper cement”. This copper cement was sold for further refining. In 1963 - 1964 Falconbridge of Africa (Pty) Ltd (Falconbridge) completed a more detailed exploration programme looking at the higher grade zones within the Haib deposit. They drilled some eleven boreholes totalling 1,012 metres of drilling. During 1968-69 King Resources of South Africa Pty Ltd (KRC) conducted a further drilling programme. They examined both lower and higher grade sulfide zones, as well as the higher grade oxide shear zones. Some leach test work was carried out. The area was abandoned in 1969.

During 1972 – 1975 Rio Tinto Zinc conducted the first extensive and systematic investigation of the Haib deposit. They drilled one hundred and twenty holes (120) totalling 45,903 metres. They conducted various sampling programmes including geochemical and geophysical prospecting.

In 1991-1992, Revere Resources SA Ltd, produced a technical brochure and promoted the Haib as a “potential world class copper producer for the 1990’s”. It would appear that the intent was to list the Haib (possibly on the JSE). For reasons unknown to the author this listing never materialised.

In November 1993, Rand Merchant Bank Ltd (of South Africa) (RMB) acquired an option over the Haib property. Venmyn Rand Pty Ltd., mining management consultants to RMB then undertook a study of the project. Work terminated in 1995.

In March 1995 Great Fitzroy Mines NL (GFM) and RMB executed an agreement in association with George Swanson to acquire 100% of the Haib project. GFM agreed terms with RMB whereby GFM could earn 90% of the project. Subsequently GFM agreed to transfer a 70% interest in the deposit to Namibian Copper Mines Inc. (NCM) in exchange for

NCM reimbursing past expenditure and providing GFM with a free 20% carried interest. NCM then purchased the remaining RMB interest leaving GFM (with a 20% free carried interest and the management) and NCM held 80%. The operating company was called the Namibian Copper Joint Venture (NCJV). From 1995-99 the NCJV prospected the Haib, managed by GFM. The names NCJV and GFM can be read as synonymous.

The mineral rights were held by Copper Mines of Southern Africa (Pty) Ltd (CMSA) as EPL 2152 and worked by the NCJV. The NCJV ran into financial difficulties and work was stopped at the Haib deposit in late 1998 to early 1999.

Rusina Mining Ltd of Perth, Australia, acquired the concession from GFM/ NCJV during 1999-2000 and they took over ownership of the Haib data. The transfer of the mineral rights to Rusina was apparently not ratified by the Namibian Government. Rusina has completed no work on the Haib deposit.

In 2003 (date uncertain) in response to the Namibian government enforcing the new Namibian Minerals Act, George Swanson finally relinquished his Haib claims.

This allowed Deep-South Mining Company (Pty) Ltd (DSM), registered in Namibia, to consolidate a single mineral rights entity over the entire Haib deposit. An initial Exclusive Prospecting licence 3140 was granted for 3 years from 22 April 2004 to 21 April 2007 over an area of 74,563 ha covering the deposit and a very large surrounding area. Until 2017, limited desk study was completed by DSM.

In 2017, METS Engineering Group assisted DeepSouth Resources Inc. in the development of a Preliminary Economic Analysis (PEA) for the Haib copper project. The PEA report was to present the findings needed for the development of the Haib project with aims to minimise or manage any possible risks or negative implications. The PEA report was completed in February, 2018.

## 5. GEOLOGICAL SETTINGS

The Haib deposit is located within part of the Namaqua-Natal Province called the Richtersveld geological sub-province which is further subdivided into a volcano-sedimentary sequence (locally, the Haib Subgroup), the Orange River Group and the intrusive Vioolsdrift suite which are closely related in space and time (Figure 5-1, Figure 5-2 and Figure 5-3). The Orange River Group is composed of sub-aerial volcanic rocks and reworked volcanoclastic sediments; deformation caused displacements along stratigraphic contacts before intrusion of the Vioolsdrift suite. The predominance of andesitic and calc-alkaline magmatic rocks with tectonic compression prevailing throughout the magmatic episode has led to an interpretation of an island-arc model for the region. Recent age dating of Haib rocks by separation of zircon and apatite on which laser ablation and inductively coupled plasma mass spectrography was used to derive the U/Pb ratios was performed at Trinity College, Dublin by Neil Grumbley and indicated an age of 1,880 Ma for the volcanics.

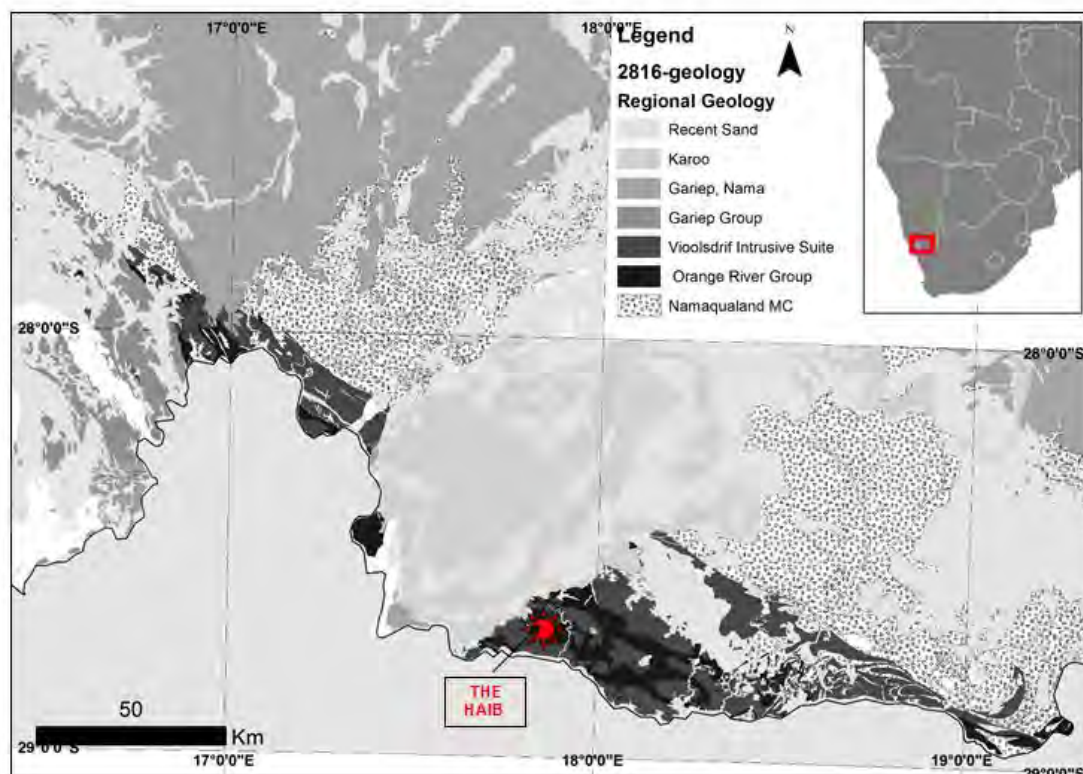

**Figure 5-1: General distribution of the Vioolsdrift and Orange River rocks**

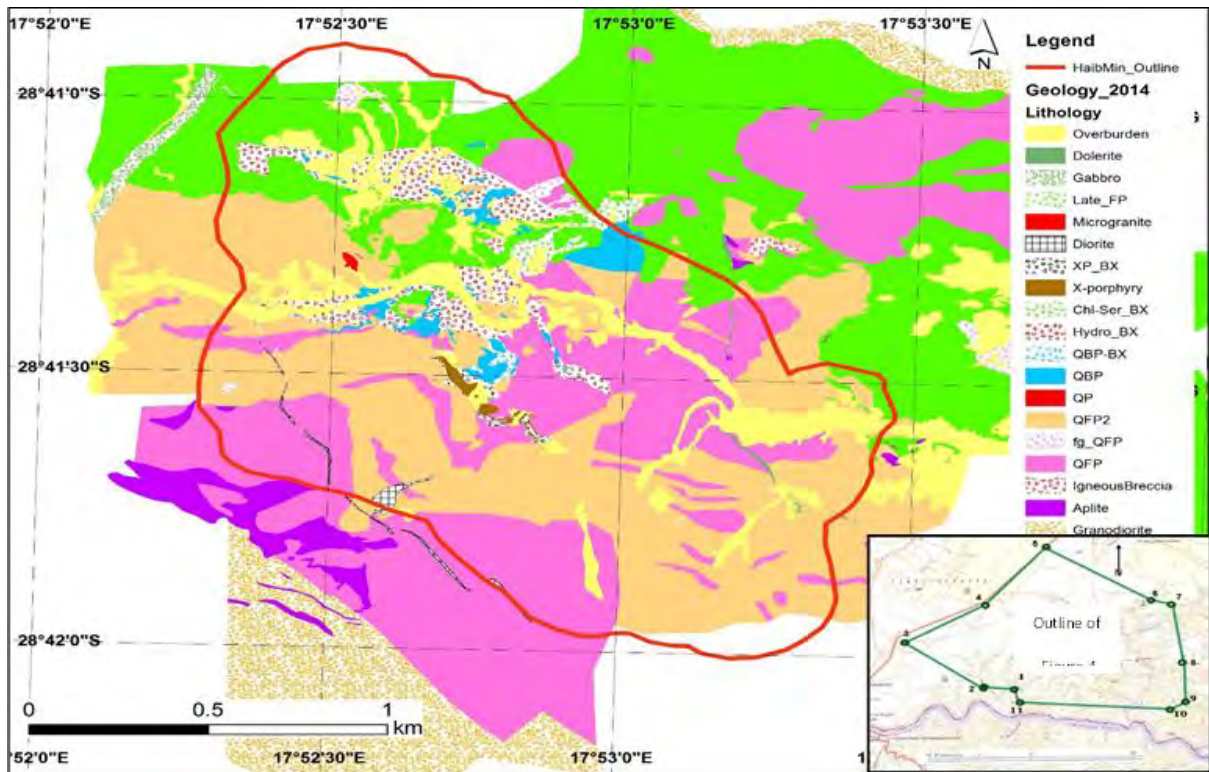
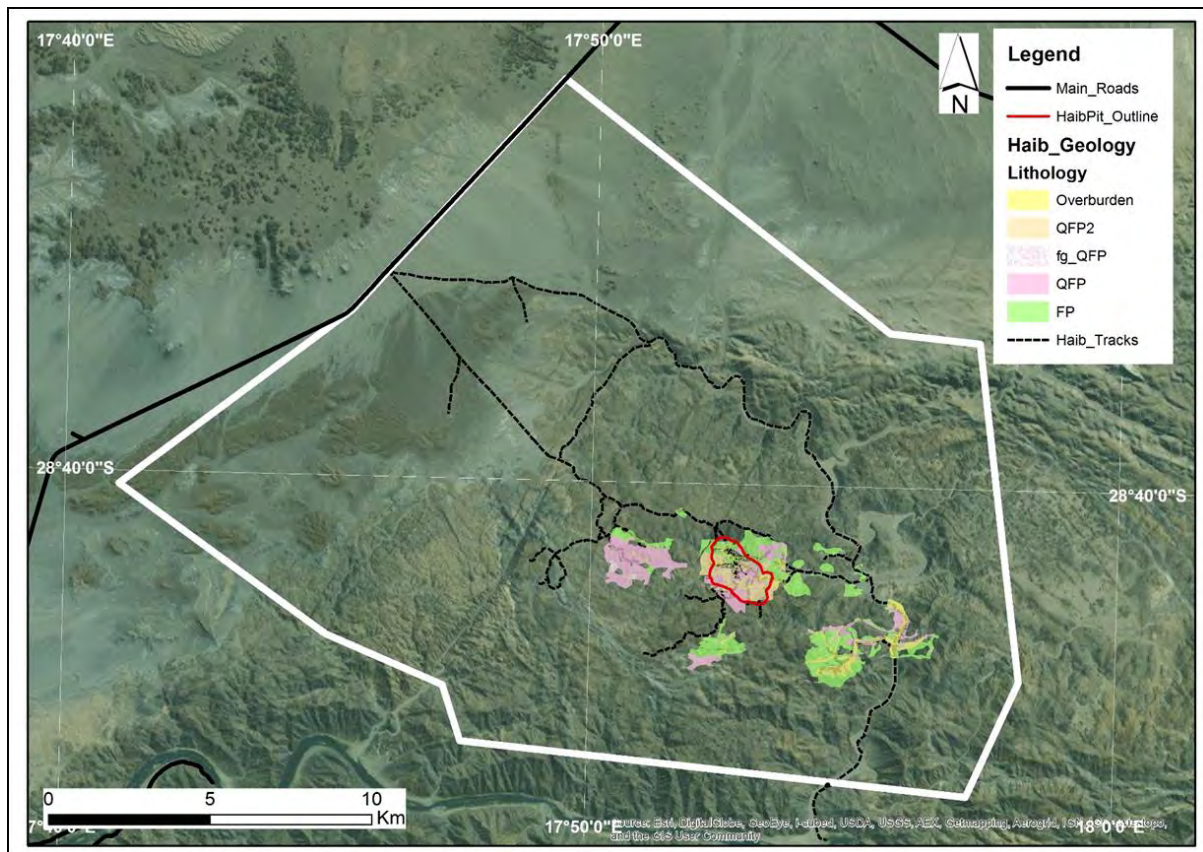

Figure 5-2: Geology of Haib (from Teck 2015)

The principal mineralised hosts at the Haib are a Quartz Feldspar Porphyry (QFP) and a Feldspar Porphyry (FP) as shown in Figure 5-2 and Figure 5-2. The QFP is interpreted as a quartz diorite body which intruded the feldspar porphyry some  $1,868 \pm 7\text{Ma}$ . The FP is generally interpreted as being part of the suit of andesitic rocks although some workers have suggested that it too, may be partially of intrusive origin. The QFP is elongated along the orientation of the Volstruis Valley, largely coincident with the location and orientation of many of the higher grade intersections within the deposit.



**Figure 5-3: Intrusive rock units of the Haib deposit (Source: Teck 2015)**

The sequence has undergone low grade regional metamorphism to greenschist facies. Most of the rock exhibits typical porphyry copper type alteration zones associated with mineralisation. A potassic hydrothermal alteration zone coincides with the main mineralised area surrounded by phyllic and propylitic alteration haloes. Propylitic sericite alteration appears to overprint the earlier potassic zones. Silicification, sericitisation, chloritisation and epidotisation are widespread. Although not present in the immediate area of the Haib deposit, some kilometres to the east of the area are outcrops of Karoo age (early Permian) mudstones, siltstones and sandstones of the Prince Albert Formation. These create very flat topography and would by their nature be very well suited to the production of heap leach pads.

### 5.1 Haib Deposit

The QFP comprise typically blue-eyed quartz and feldspar phenocrysts within a medium grained rock mass of quartz, feldspar, sericite, biotite, chlorite, epidote and calcite. The FP is generally a medium to fine grained rock of similar composition but without the quartz phenocrysts and with a higher proportion of chlorite and epidote. Minor basic dykes and quartz veins traverse the area. Rocks within the Haib area are hard and competent but generally well jointed with both flat and steeply dipping joint sets being well developed.

Striking east-west along the Volstruis River is a well-developed zone of steeply dipping shears. The orientation and location of the main mineralisation coincides with the fracture zone which is interpreted as representing a focus of the intrusion and channel ways for mineralising fluids. The fracture zones likely represent the local stress regime at the time of porphyry formation and control the orientation of high grade zones, and were later re-activated by the Namaqua deformation event circa 1,100 Ma ago (Figure 5-4).

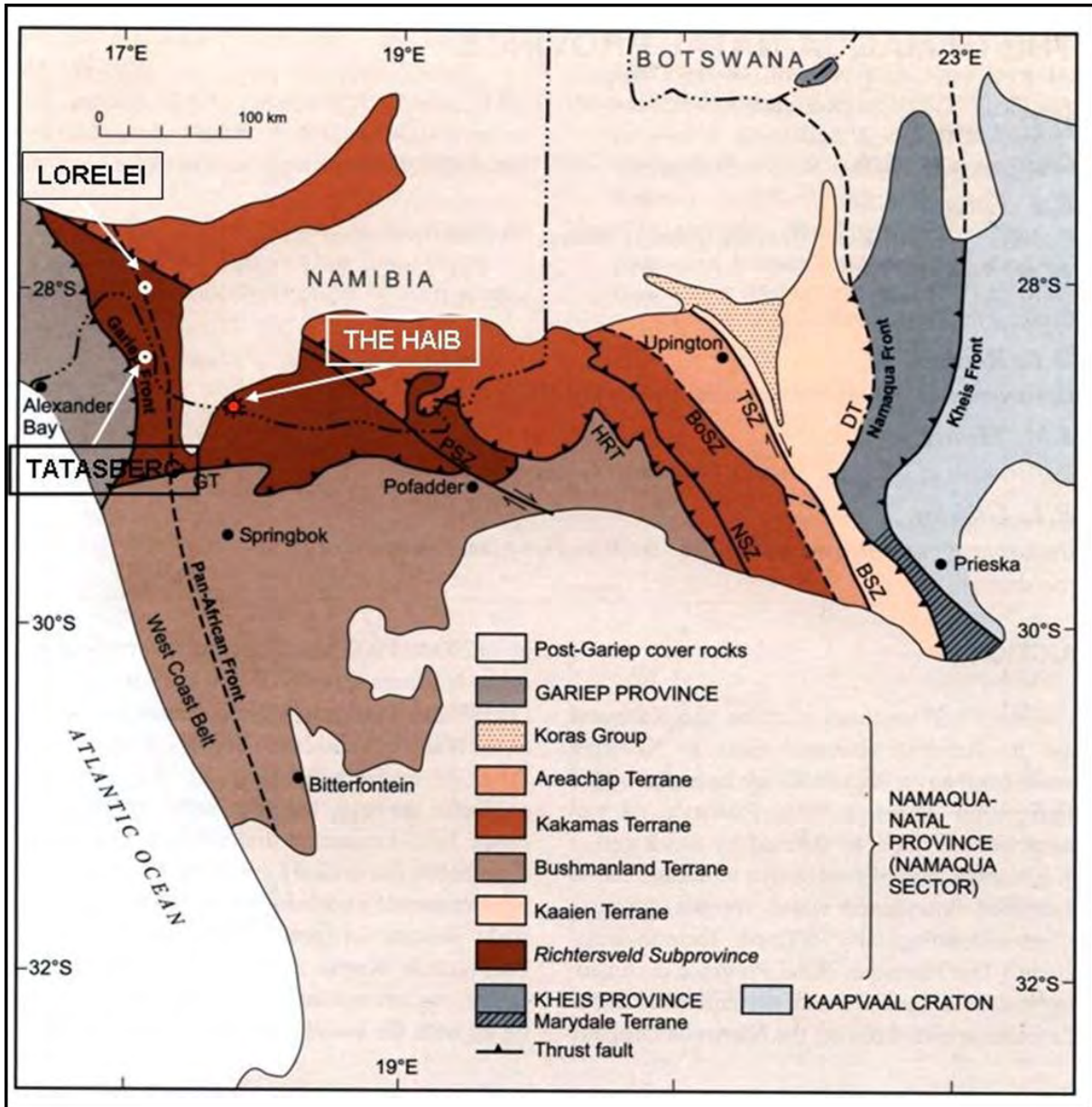
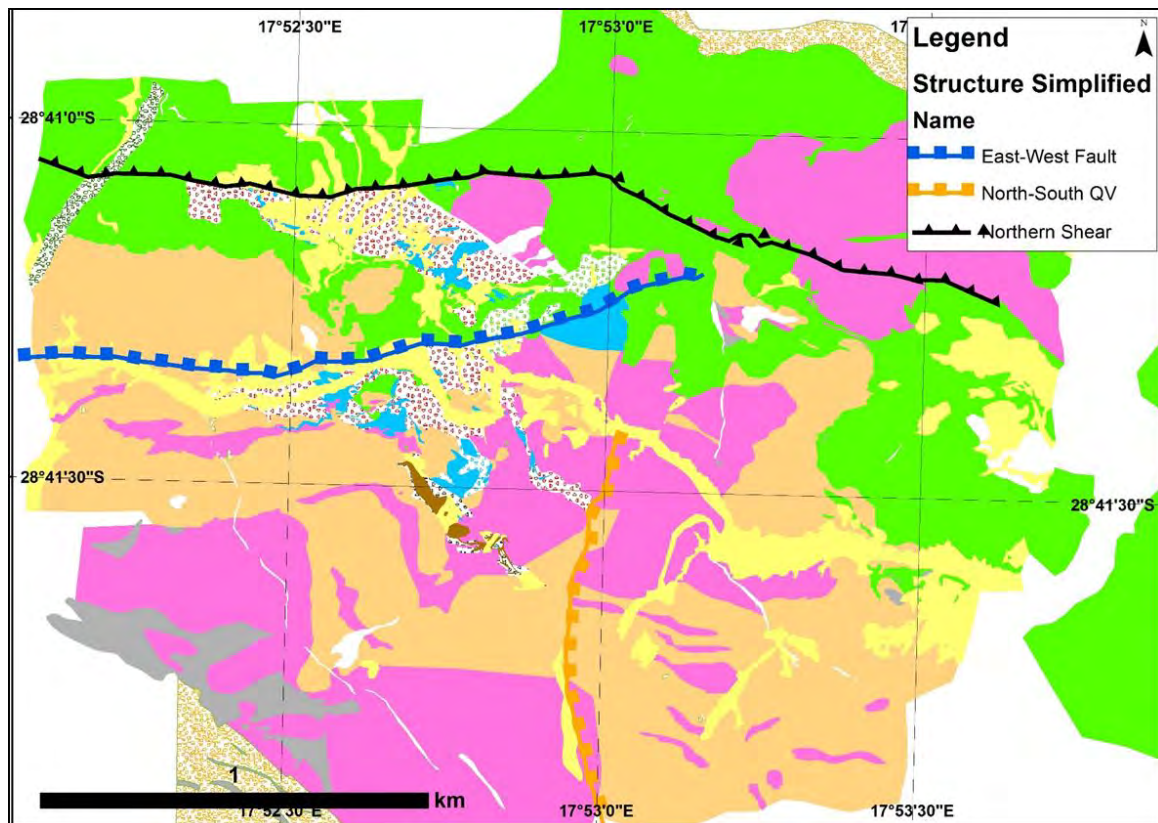

Figure 5-4: Tectonic sub-division of the Namaqua sector of the Namaqua-Natal Province

## 5.2 Structural Controls on Copper Mineralisation

Mineralisation at Haib is typical of a porphyry copper deposit and despite the age of the deposit, and the fact that the mineralisation has been subjected to local post-mineral

deformation, the deposit remains relatively intact. Detailed mapping by Teck geologists within the main deposit area has shown that high grade copper mineralisation is controlled by a fracture/vein set that parallels a regional structural trend and strikes N60°W and dips steeply (-70°) to the southwest. This high grade zone also appears to plunge at 30° to 40° towards the south-east (see Figure 5-5 and Figure 5-6). This model has significant economic implications as it suggests that the higher grade zone of copper mineralisation has not been adequately tested by the historical vertical drillholes and that inclined drillholes will better define the extent and tenor of this mineralised zone. If this model is correct then systematic inclined drilling could better define the high-grade sections leading to better pit design to exploit near-surface high grade mineralisation at the start of mining operations.



**Figure 5-5: Map of the three main structures at Haib**

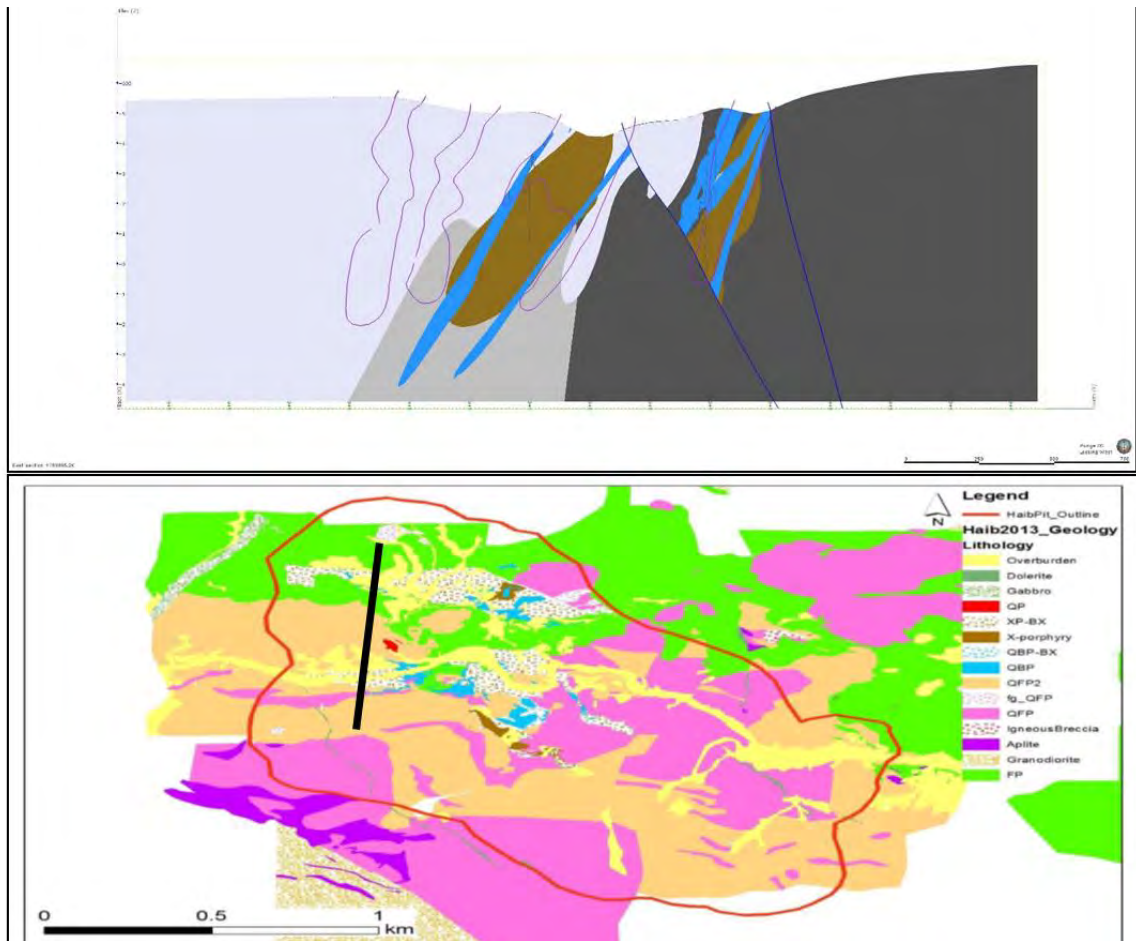

**Figure 5-6: North-south cross-section across the western end of Haib**

Teck has also defined four new target areas near to the main deposit and three other target areas on the property, namely the SW alteration feature, the NW IP anomaly and the E alteration feature that are, as yet, poorly defined (Figure 5-7). The well-defined targets, referred to as the eastern, southern, south-western and western anomalies, have been defined using geological mapping, stream and soil sample geochemistry and geophysical surveys using IP with several diamond drillholes in three anomalies (east, south and west) to determine the extent and tenor of mineralisation.



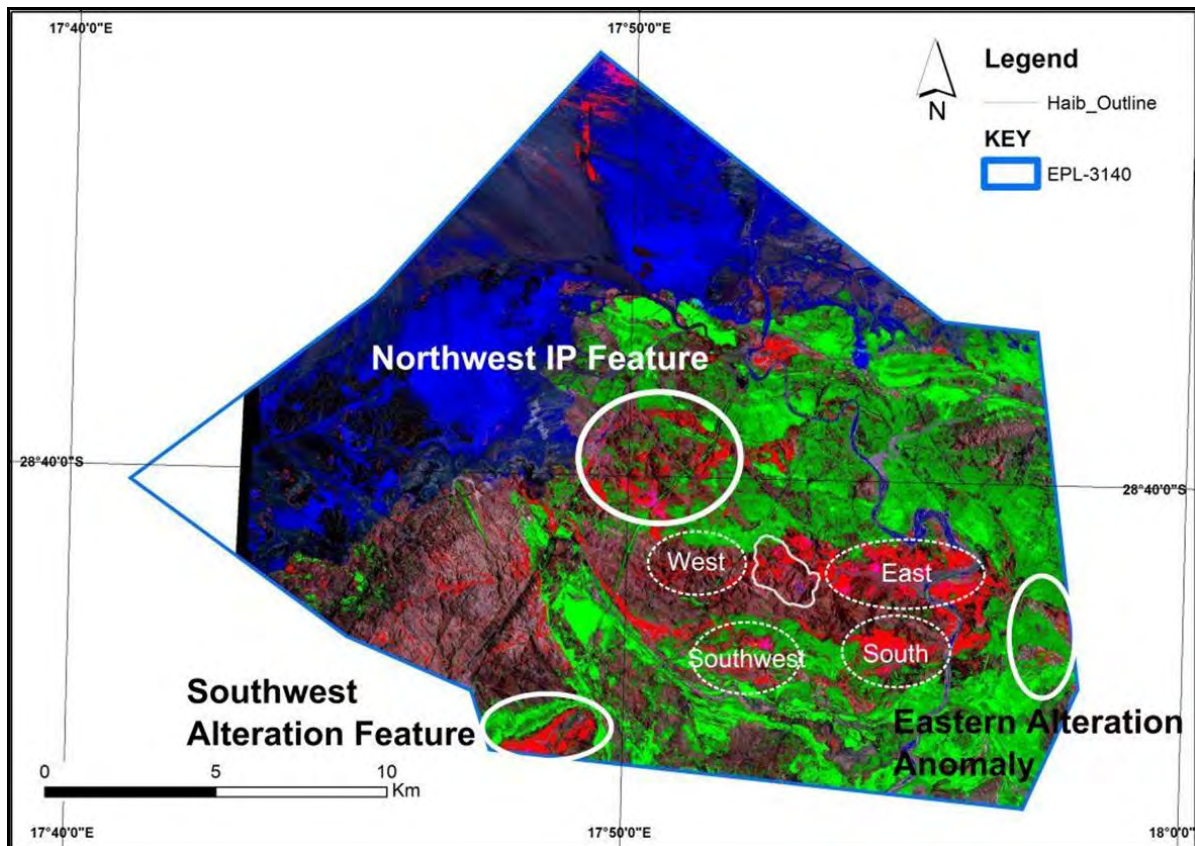

Figure 5-7: Haib deposit anomaly map

### 5.3 Mineralization

The Haib deposit is in essence a very large volume of rock containing copper mineralisation. The grade is variable from higher grade in the three core zones (possibly averaging >0.4%) progressively dropping towards the margin of the deposit. The area in which mineralisation has been identified equates approximately to the outer ring of the GFM 22 year pit design. This gives a pit size of 2200x1250x400 metres equating to some 1300 million tons of mineralised rock. The deposit is still partially open to the west (at surface) and to the south at depth.

Mineralisation is not confined to any specific units although the quartz feldspar porphyry tends to contain the three higher grade zones. Mineralisation is clearly secondary and post-dates the formation of the original volcanic pile. Mineralisation is widespread throughout although frequently associated with fractures and joints.

The principal sulfides within the Haib body are pyrite and chalcopyrite with minor molybdenite. Bornite, digenite, chalcocite and covellite are also occasionally recorded. There is no major development of a supergene zone, probably due to high rates of erosion associated with the Orange River canyons. Near surface oxidation has led to the formation of malachite, azurite, chrysocolla, minor cuprite and chalcocite, generally along fracture

zones. Oxide copper rarely extends to depths in excess of 30 metres on these fracture zones. While the oxide zone volumetrically represents a fairly minor proportion of the deposit, grades are significantly above average giving the potential for some leachable copper from the oxide material. These portions of the deposit have not been examined in detail and there is significant potential to improve their volume and grade.

In addition, there is a variable thickness of transition zone generated over large parts of the deposit, between the surface and a pure sulfide (un-oxidised) zone of some 10-20 metres thickness.

Sulfide minerals are disseminated within the rockmass and found concentrated in blebs and along veinlets and fractures. Significant mineralization commonly occurs along joint planes.

Gold, silver and molybdenum are trace constituents associated with the copper mineralisation. Molybdenite is occasionally seen as disseminated flakes and veinlets associated with other sulfides and in minor shears and quartz veins. Assaying for gold, silver and molybdenum was not routinely conducted on drill samples but has been carried out on composite samples prepared for metallurgical testing, giving an approximate indication of the likely values. Values determined were: - 0.02 g/t gold; 0.9 g/t silver; and 25 g/t molybdenum.

## **6. DEPOSIT TYPES**

The Haib copper deposit is a rare example of a Precambrian porphyry copper. Porphyry copper deposits are a major world source of copper (also molybdenum, silver and gold) with the best known examples being concentrated around the Pacific rim, in North America, South America, and areas such as the Philippines. Most of these deposits are relatively young, of Tertiary or Cretaceous age. The Haib deposit, which has many characteristics in common with these porphyry coppers, is very much older, being formed within Proterozoic rocks.

## **7. DRILLING**

### **7.1 Historical Drilling Data**

At least five separate drilling programmes have been conducted at the Haib. For dates of these programmes see the History Section. The first drilling was completed by Falconbridge who drilled eleven drillholes into the deposit in three principal areas of interest totalling some 1,012 metres of drilling. The average grade of the intersections was given as 0.33% Cu. Very little of this data remains other than the drill core assays.

After Falconbridge, King Resources conducted a drilling programme of 21 holes totalling 3,485 metres. Again, this programme has very little useful data surviving although drill assays are available and the drillhole collars have been located.

Subsequently RTZ drilled one hundred and twenty drillholes, mostly vertically, on a systematic 150 metre grid giving a total 45,903 metres drilled. Holes were on average 300-400 metres deep. These cores were preserved in a core shed at the old RTZ campsite and were available to GFM. The information from these drillholes was verified by GFM and incorporated into their geological model. This information was therefore used by Behre Dolbear in the Haib resource evaluation.

Finally, the NCJV/GFM drilling programme completed a further 12 fill-in drillholes for analytical purposes and another 5 large-diameter drillholes for geotechnical work. These will not be reported in detail as they were drilled after the Behre Dolbear resource evaluation and are not considered in this report.

### **7.2 Core Recovery**

The Haib ore is very competent with no oxide capping. As a result core recovery from drilling is excellent.

## **8. SAMPLE PREPARATION, ANALYSIS AND SECURITY**

### **8.1 Sample Method and Approach**

All drillholes drilled by Falconbridge, King Resources and RTZ were located and resurveyed by NCJV. The eastings and northings were generally found accurate but there were significant discrepancies (up to 80 metres) in the reported drillhole elevations. This factor represented a constraint on the accuracy of the data and on the confidence limits placed on the resource estimates but it was not considered that it would have a significant impact on the overall resource figure.

This issue was subsequently resolved by the NCJV which commissioned an orthophoto survey of the area and generated a new surface topographic plan. All drillhole assay data is based on diamond drill core, generally “N” or “B” sizes. Drillhole spacing was generally on a regional 150 metre grid. The Rio Tinto drillholes are mostly vertical, while the earlier Falconbridge and King Resources drillholes are inclined. One section line 865 E has been partially drilled at 25 metre spacing. This was the line along which the adit was developed by the NCJV.

Sample recovery was generally good. Most of the earlier drill core was hammer-split and half core was sent for assay. The Rio Tinto cores were sampled at 2 metre intervals and sampled for total copper and where appropriate, oxide copper. Composite samples from each drillhole were tested metallurgically to determine recoverable copper and were assayed for molybdenum, silver and gold indicating average contents of 25 g/t Mo, 0.01 g/t Au, and 0.9 g/t Ag. The reliability of these numbers cannot be assured.

From all of this information Venmyn Rand constructed a database of the available 1963-1975 drillhole data using drillhole logs (as the original assay data sheets were generally unavailable). The data base comprised 152 drillholes – 120 from Rio Tinto, 21 from King Resources and 11 from Falconbridge.

### **8.2 Sample Preparation, Analysis and Security**

The database comprised approximately 24,000 samples of which the vast majority are 2 metre samples from the Rio Tinto drilling (22,800). The King Resources samples averaged 4.5 metres average length, while the Falconbridge samples were an average 3.0 length.

Of the total samples approximately 15,000 have values greater than 0.1% Cu but only 1,100 have values greater than 0.5% Cu. The acid soluble database was said to comprise 1,980 samples.

Specific gravity measurements were carried out by Rio Tinto on 40 drillholes giving approximately 7,000 determinations. Densities ranged from 2.43-3.35 and averaged 2.71. GFM continued the process on subsequent drilling, sampling every tenth sample.

It is not possible to comment on the analysis and security attached to these samples. It is known that the Rio Tinto samples (22,800) were all prepared on site, Rio Tinto having a prep-laboratory at the campsite. It is believed that the actual analysis was done off site but the details are unknown.

## 9. DATA VERIFICATION

Original assay laboratory sheets were not located for the Falconbridge, KRC, or Rio Tinto data. In addition there were no records of any assay duplicates, field re-splits or check assays having been carried out by independent laboratories.

The NCJV drilling (completed after the Behre Dolbear resource estimation), supported the previous assay results but could not verify them.

Rio Tinto in addition prepared extensive metallurgical composites comprising sequential down hole samples over approximately 20 metres. A resource estimate carried out by GFM based on the composite data gave comparable results. No direct check has yet been undertaken on a comparison of composite grades with original sample grades. Composite samples were assayed for copper, molybdenum, gold, silver and sulfur.

## **10. MINERAL PROCESSING AND METALLURGICAL TESTING**

### **10.1 Metallurgical Testwork**

#### **10.1.1 Introduction**

Previous testwork programmes and reviews of the Haib Project identified the two most promising options to be:

1. Beneficiation of the ore by dense media separation to reduce the amount of material to be milled for concentration by flotation; and
2. Bioleaching of the ore/rejects stream using BioHeap technology, removing the need for concentrating of the ore and subsequent roasting, leaching and electrowinning.

For either of these procedures to be successful, two key issues need to be addressed. Firstly, most of the resource is contained in disseminated, fine-grained chalcopyrite that is distributed throughout the entire orebody. Due to this, there are problems with the difficulty and cost associated with grinding the granite host rock to liberate the copper minerals. Processes such as beneficiation and leaching, however, are generally more efficient when working with smaller particles. Therefore, it must be determined what proportion of the ore can be put through crushing, and to what particle size, and how much material of a certain grade recovered from beneficiation is to be milled for flotation, and the operation remain economical.

Secondly, the intensity of the chalcopyrite mineralisation varies across the deposit. The consequence of this is that a finely-tuned beneficiation or leaching procedure may not be applicable to the processing of the entire resource. If it was practical and economic to separate the areas of differing-intensity mineralisation before processing each, this would not be a concern. If not, attention would need to be paid to the characteristics of the host rock for each area, and a process designed for each accordingly.

Multiple Studies and testwork have been completed on this deposit over a number of years with extensive studies into the mineralogy that dates back to 1975 when Rio Tinto owned the deposit. There have been previous reports issued by METS on the Haib project with the results of the report outlined below.

METS have undertaken a metallurgical testwork program (2019/2020) to further investigate and assess the treatment response of the Haib ore to different technologies such as ore sorting and heap leaching. The testwork has showed positive results from the column bacterial leaching tests achieving a maximum copper recovery over 82.2%.



### 10.1.2 Mineralogy

The Haib Copper Deposit is a large sulfide ore deposit. The following resource estimates were developed by the Namibian Copper Joint Venture (NCJV) in 2006 (Table 10-1):

**Table 10-1: Previous Haib Indicated Resource Figures**

Haib Indicated Resource								
Minimum Block Grade	GFM Model		BehreDolbear's Model					
			Kriging		Inverse Distance Squared		Nearest Neighbour	
	Million Tonnes	Grade % Cu	Million Tonnes	Grade % Cu	Million Tonnes	Grade % Cu	Million Tonnes	Grade % Cu
0.1	1350	0.23	1353	0.23	1331	0.23	1184	0.25
0.2	730	0.28	739	0.29	726	0.29	630	0.34
0.3	230	0.37	244	0.37	262	0.38	292	0.46

From the indicated figures it can be seen that there is a large amount of relatively low grade copper. Copper is mainly present as a sulfide in the form of chalcopyrite. Copper is also present as oxides (chrysocolla, plancheite, malachite and azurite), occurring as intrusions in shear zones. Initial testwork results showed that the Haib mineralisation is a competent quartz feldspar porphyry rock. It can be seen that the main ore component is copper with only an accessory amount of molybdenum present. The chalcopyrite also occurs as occasional coarse irregular grains from 0.1 mm to 0.35 mm. It is clear that fine grinding will be required to liberate much of the chalcopyrite.

### 10.1.3 Prior Testwork

#### 10.1.3.1 Comminution

Prior testwork has been conducted to determine the characteristics of the ore and its amenability to crushing. Table 10-2 shows the results from a comminution program from Minproc. The data indicates that this is a hard ore that will require large amounts of energy to crush and grind. HPGR on the other hand requires far less energy than grinding.

**Table 10-2: Comminution Data**

Head Grade		0.31% Cu
In-Situ Density		2.6 t/m <sup>3</sup>
Specific Gravity		2.7
Ore Density	Mass Calc	1.8 t/m <sup>3</sup>
	VolCalc	1.65 t/m <sup>3</sup>
Crushing Work Index	QFP	21.5 kWh/t
	FP	24.0 kWh/t
	Design	22.3 kWh/t
Unconfined Compressive Strength (UCS)	Design	150 MPa
Abrasion Index (Ai)		0.485
Angle of Repose		36°
Angle of Reclaim		55°
Ball Mill Work Index (BWi)	QFP	16.8 kWh/t
	FP	20.3 kWh/t
	Design	18.0 kWh/t
Rod Mill Work Index (RWi)	QFP	19.8 kWh/t
	FP	25.1 kWh/t
	Design	21.6 kWh/t

### 10.1.3.2 BioHeap Leach

BioHeap™ is a heap leach technology, which it is claimed is able to treat chalcopyrite ores through careful selection of bacteria that attack chalcopyrite preferentially to pyrite. This avoids the build-up of elemental sulfur, a common problem with chemical-based leaching, as it brings about passivation of the mineral surface. Preventing this improves leach kinetics, which is a major advantage of the BioHeap™ process.

Preliminary testwork showed that the Haib ore became more susceptible to leaching as the particle size was decreased, and that the actual leaching of copper in preference to iron by the bacteria was very successful. A bacterial leach study by the University of Witwatersrand has been conducted which extrapolates short term results to infer long term. A constant diffusion coefficient is used which doesn't account for passivation layer build-up. The information suggests:

- Copper recoveries are better for smaller ore sizes and worst for larger fractions (ie. Smaller particle have better leaching kinetics)

- Iron concentration was stabilised at 6.5 to 8.5 g/L of Fe(III), periodically removing by sulfuric acid yielded copper extraction increasing by 15%
- Temperature of the column was 30°C but rose to 40°C over 2 weeks
- Magnesium and aluminium build-up was six times faster than copper

This study suggested that high copper extractions can be achieved in column leaching conditions; however the method of extrapolating the data may be open to criticism.

Additionally AMMTEC conducted testwork on bacterial oxidation; they conducted bacterial testing on a 100% passing 32 mm crush size. The testwork conducted was a single bacteria oxidation test that used a chalcopyrite specific bacteria culture. A 1% w/v milled ore to bacteria culture was used and maintained at a pH of 1.8. The results concluded that the ore was amenable with bacterial oxidation and gave high oxidation (95.2%) of copper.

In 2003, heap bacterial leaching testwork was performed by Mintek to establish the agglomeration requirements for different crush sizes and to assess the amenability of Haib oxide and sulfide ores to heap bioleaching. Mintek's bacterial cultures were used and the columns were operated at a temperature range of 28°C to 30°C for oxide ores and 20°C to 70°C for sulfide ores. This testwork programme showed that heap bioleaching can achieve good copper extraction for both oxide and sulfide ores. The key findings from this testwork programme are as follows:

- Oxide ore heap leaching
  - These tests indicated that the smaller the leached particles and the more acidic the conditions, the higher the copper extraction obtained. The highest extractions were obtained for finer crush sizes.
  - Acid requirements were in the order of 1.4 to 3.1 kg acid/kg copper.
  - The ore was found to agglomerate relatively easily with acid concentration of around 5 g/L, and higher.
- Sulfide ore heap bioleaching
  - The tests on the milled ore confirmed particle size and temperature as the primary leach parameters for the Haib sulfide ore sample.
  - The copper leach kinetics improved with increasing temperature and reduced crush size. High redox potential was also required to maximise copper leach kinetics.
  - The sulfide ore is difficult to agglomerate.

- The best copper extraction was obtained for a crush size of 6 mm and a temperature of 65°C which yielded a copper extraction of 80% after 200 days.

#### **10.1.4 Metallurgical Studies and Process Optimisation**

A previous report issued by METS in March 2006, presented and discussed alternative processing options to the conventional roasting for extracting copper from chalcopyrite.

The processing options it was proposed be investigated and tested were:

- Heap leaching by a bacterial-assisted leach technology; and
- Production of a concentrate after beneficiation.

Options for processing a concentrate on site were also examined. A preliminary evaluation of the various processes found that the most attractive options were Intec®, Total POX, Geocoat and Activox®. It was considered that the return per tonne of ore treated by any of those routes needed to be increased via beneficiation and flotation to be viable at any scale.

Process options for recovering magnesium and aluminium from leach solutions were presented, as these elements were found to leach in the biological leaching. It was determined that these metals were not able to be extracted economically.

It was recommended that metallurgical testwork be carried out to determine the applicability of bacterial leaching technology and of concentrate production using beneficiation and flotation. This was to be done in a number of phases at the laboratory scale and the pilot plant scale.

#### **10.1.5 2019/2020 Metallurgical Testwork**

METS have undertaken a metallurgical testwork programme (2019/2020), which is centred on heap bioleaching of the low-grade Haib copper sulfide ore. The objectives of this testwork programme are to optimise process parameters and assess process viability especially ore sorting. Some of the key findings from the testwork results are summarised below:

- The ore sorting testwork showed that nearly half of the mass treated was ejected producing a higher grade concentrate and achieved an overall copper grade of 1.36% which corresponds to an upgrade factor of 1.73. Although the ore sorting results showed positive results for low-grade Haib ore beneficiation, the loss of copper (~30%) to the tails and additional CAPEX and OPEX of ore sorting suggest that ore sorting is not the preferred route for processing the low-grade Haib ore. Crushing and heap leaching the ore will provide a higher overall copper recovery than ore sorting followed by heap leaching.

- The HPGR optimisation testwork were performed at 30 bar, 60 bar and 90 bar. The results suggested that 60 bar is the optimum pressure.
- The net acid consumption was estimated to be 11 kg/t for a pH of 1.5 and 10 kg/t for a pH of 2. The total acid consumption was calculated to be 11.5 kg/t for a pH of 1.5 and 10.5 kg/t for a pH of 2.
- The mineralised material agglomerated without any issues as opposed to the 2003 Mintek testwork indicating that the leaching solution will be able to percolate through the heap easily and hence maximise copper dissolution.
- The batch agitated leach tests showed that bacterial leaching is a viable option and achieved good copper recovery. The batch chloride leaching which showed very poor results suggested that it is not suitable for processing the Haib ore.
- The geomechanical stacking test results suggested that a 6 m stacking height can be accommodated for percolation leaching for crush sizes: -2.36 mm, -3.35 mm and -4.75 mm.
- The column leach tests have shown very promising results, achieving copper recoveries ranging from 75% to 82.2% which suggest that bacterial leaching is suitable for processing the low-grade Haib ore. Additional testwork will be required to confirm the results and optimise the process parameters.
- In columns, the acid generation from bacterial leaching of the pyrite resulted in a continual decrease of pH. The pH will need to be adjusted to around pH 2 for solvent extraction. Some neutralisation will be required. Column leaching with continuous recycling is required to assess the actual acid requirement which is expected to be very low.
- The iron removal tests showed that an iron removal efficiency of 99% was achieved at a pH of 4 without loss of copper to the precipitate. This suggests that the pH of 4 is the optimal condition for the iron removal process.

It is important to note that the proposed flowsheet was not possible twenty years ago when the project was discovered. Firstly HPGR was not developed to the state where it is today allowing fine crushing. Secondly chalcopyrite could not be leached. Work over the last ten years has perfected strains that can survive at higher temperatures where the chalcopyrite will not passivate and leaches over time. Mintek has been a global leader in this area of bacterial leaching.

## 11. MINERAL RESOURCE

### 11.1 Introduction

In July 2017, Obsidian Consulting Services, an independent geological consultancy, conducted a mineral resource estimate for the Haib Copper Project using the outputs of some 3D modelling work that had been completed by Teck using the LeapFrog GEO software package. The models were analysed with respect to their grade distributions and appropriate domains were selected on which the mineral resource estimate was then based. A mineral resource classification based principally on data density was applied to derive a mineral resource statement.

### 11.2 Source Data

#### 11.2.1 Drillhole Data

All the available drill hole data for Haib was compiled in a single Geovia-GEMS project. The summary statistics of the complete compiled drill hole database are given in Table 11-1. Of significance from this is the fact that copper assays outnumber molybdenum assays by more than 3:1 while the deepest intersections achieve a depth of more than 800m below topography.

**Table 11-1: Summary drilling statistics by drilling programme**

Series	No. Holes	Suitable for Estimation	Total (m)	Average m/hole	Max. Depth	Cu Assays	Mo Assays	
							Assayed	Visual
ADIT01	1	1	126.00	126.00	40	63	63	
GFMHB01 - GFMHB12	15	15	4,726.40	315.09	464	2,186	2,034	
H01 - H12	11	11	1,010.72	91.88	225	253	0	
HB001 - HB210A	121	121	45,795.15	378.47	653	22,838	1,530	1630
KO1 - KO4	3	3	151.49	50.50	49	34	0	
KS01 - KS21	18	18	3,324.76	184.71	288	727	0	
TCDH-01 - TCDH032	32	32	14,252.93	445.40	796	5,999	5,999	
	<b>201</b>	<b>201</b>	<b>69,387.45</b>	<b>345.21</b>		<b>32,100</b>	<b>9,626</b>	<b>1,630</b>

The positions of the drill holes relative to the modelled portion of Haib are given in Figure 11-1. The drill hole collars are coloured as to whether they were subjected to a QA/QC programme (red) or not (black).

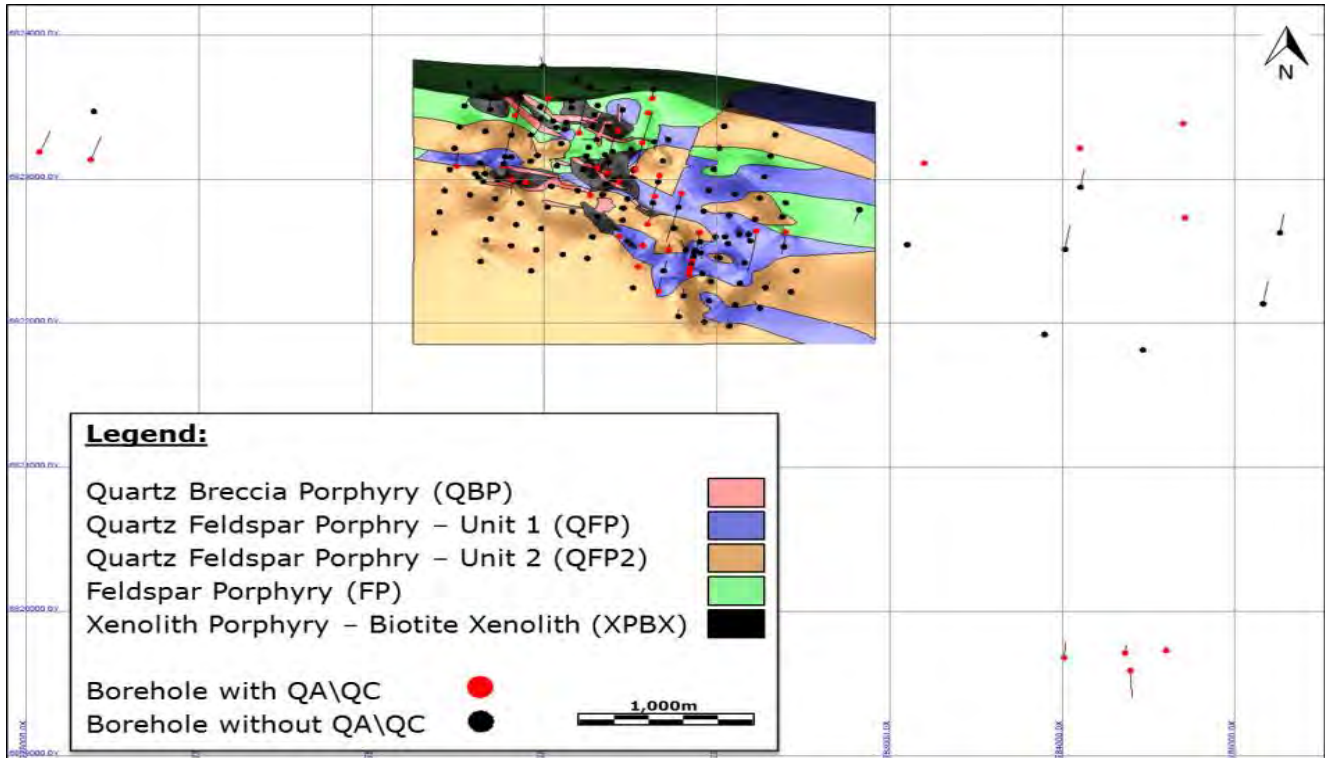

**Figure 11-1: Plan showing the limits of geological modelling conducted by Teck with the available drilling overlaid**

### 11.2.2 Three Dimensional Models

A summary listing of the received 3D models from Teck is given in Table 11-2 while Figure 11-2 shows an isometric view of the data. The geological model comprises major faults as well as lithological models. The copper grade isoshells were provided, the first approximating a 0.3% grade limit, the second 0.2%. An isoshell of molybdenum grades elevated above background levels was also received.

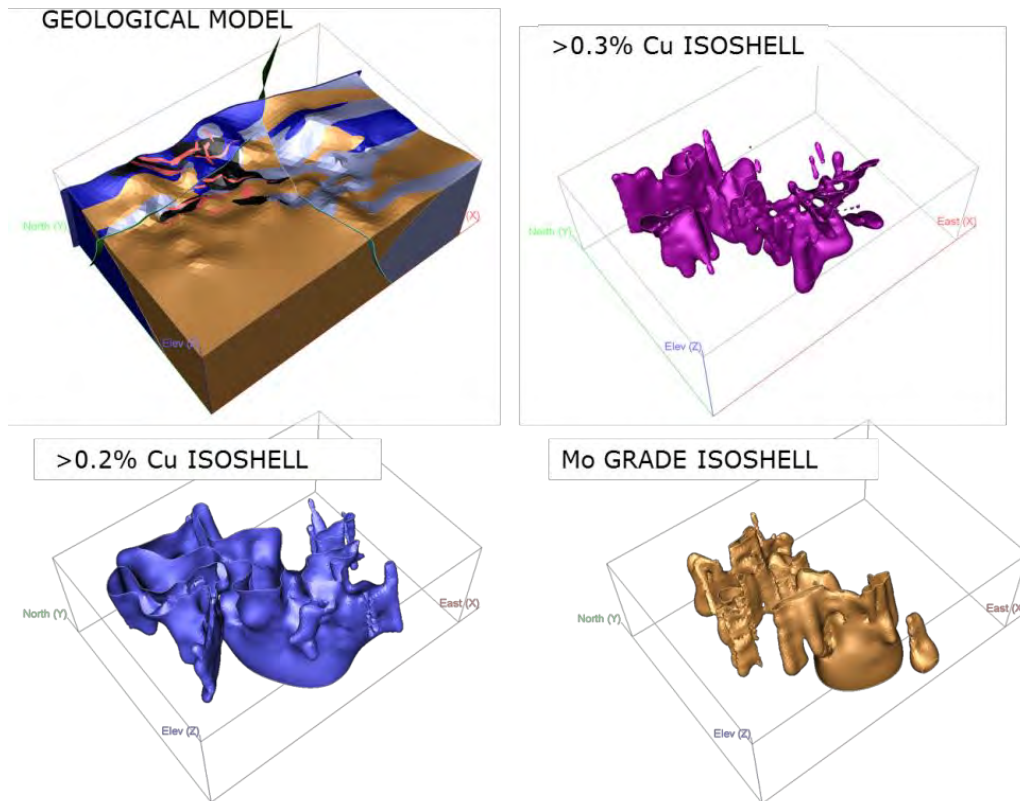

Figure 11-2: Isometric view showing the various 3D models received from Teck.

Table 11-2: Listing Of Files Received From Teck

Type	LeapFrog File
<b>Topography</b>	Haib_Topography.dxf
<b>Structural Model</b>	GM_Lithology -EW FAULT.dxf
	GM_Lithology -NorthShear.dxf
	GM_Lithology -NS QV.dxf
<b>Geology</b>	GM_Lithology -FP.dxf
	GM_Lithology - QBP.dxf
	GM_Lithology - QFP.dxf
	GM_Lithology - QFP2.dxf
	GM_Lithology - XPBX.dxf
<b>Grade Isoshells</b>	GM_GradeOutlines - High Grade.dxf
	GM_GradeOutlines - Low Grade.dxf
	GM_GradeOutlines - Mo Outline.dxf

### 11.3 Domain Selection

Each of the solid models received represents a potential domain for resource estimation and reporting. The univariate statistics were calculated for each and are shown in Table 11-3. The molybdenum mineralisation isoshell was not considered and molybdenum was viewed as secondary relative to copper. Of the lithological models, the QBP and XPBX show the highest mean and median grades, followed by the QFP's and then the FP.

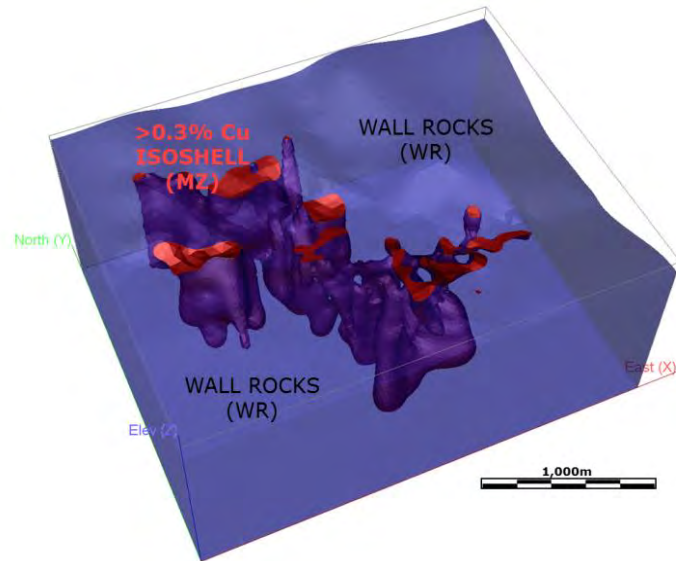

**Table 11-3: Summary Univariate Statistics By Domain.**

	Cu (ppm)							
	All	FP	QBP	QFP	QFP2	XPBX	>0.3 Cu	>0.2 Cu
<b>Count</b>	32,100	2,929	2,074	6,808	10,159	3,679	5,738	13,969
<b>Minimum value</b>	0.4	5.0	100.0	12.8	50.0	5.0	5.0	5.0
<b>Maximum value</b>	44,700	22,420	21,500	38,000	33,800	24,000	38,000	38,000
<b>Mean</b>	1,759	1,598	2,458	2,033	1,740	2,966	3,545	2,742
<b>Median</b>	1,300	800	2,000	1,600	1,400	2,300	3,000	2,200
<b>Geometric Mean</b>	1,071.6	828.3	1,877.1	1,484.8	1,300.8	2,116.2	2,819.2	2,136.8
<b>Standard Deviation</b>	1,873	2,054	1,870	2,035	1,528	2,442	2,527	2,196
<b>Coefficient of variation</b>	1.06	1.29	0.76	1.00	0.88	0.82	0.71	0.80
<b>Skewness</b>	4.15	2.99	2.17	5.50	1527.61	1.93	2.94	3.61
<b>Kurtosis</b>	42.53	16.86	12.51	58.53	0.88	9.37	20.16	30.44

There is considerable vein development and disseminated mineralisation in the QFP and FP wall rocks. In short, the imprint of mineralisation crosses these lithological contacts and as such stationarity (a requirement for estimation) within the lithologies is perhaps questionable.

Therefore, it was decided to base the mineral resource domain on the >0.3% Cu iso shell which provides a better representation of higher grade mineralisation. As the wall rocks to the >0.3% Cu iso shell are also mineralised, it was decided to define the mineral resource as comprising a central relatively high-grade copper mineralised zone called the Main Zone (MZ) and its wall rocks (WR). These are shown in Figure 11-3. The remaining work done in compiling the Haib mineral resource estimate and classification was based on these two domains only.

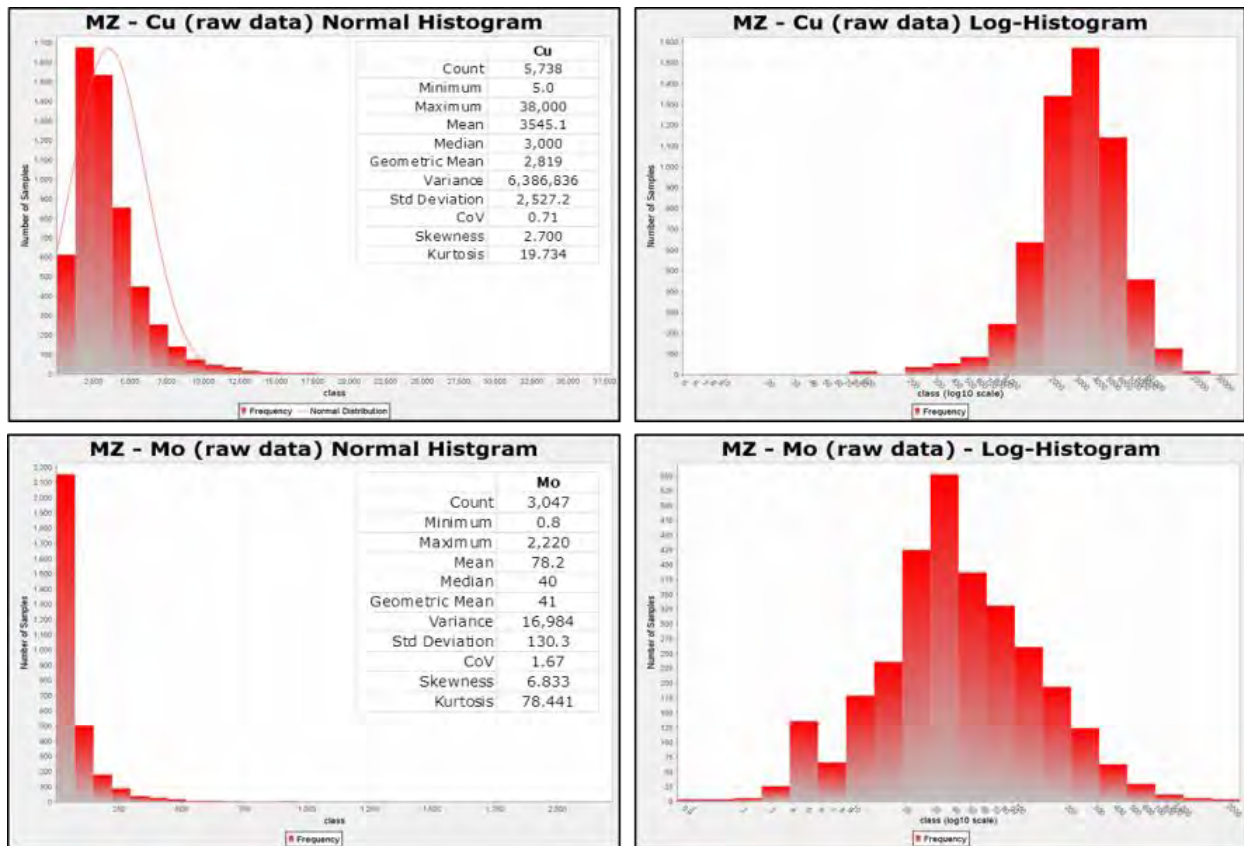

**Figure 11-3: Isometric view showing the Haib mineral resource model with a contained higher grade Main Zone (MZ) and surrounding Wall Rocks (WR).**

## **11.4 Statistical Analysis**

### **11.4.1 Univariate Statistics**

The univariate statistics for copper and molybdenum in the MZ are shown in Figure 11-4. Both populations are positively skewed, particularly the molybdenum grades. For copper, the median and mean values are similar and the coefficient of variation is less than 1, i.e. the standard deviation is less than the mean.



**Figure 11-4: Normal and log-histograms of the distribution of Cu within the MZ along with the associated summary statistics.**

The WR basic statistics are given in Figure 11-5. Distributions are positively skewed again but in the case of copper significantly more than for the MZ. Two sub-populations can be seen in the copper log-Histogram, the first at 100 ppm while a second at ~1,600 ppm is also evident. This is probably indicating some level of mineralised and un-mineralised portions within the WR and is expected to some degree as mineralisation here comprises vein/fracture mineralisation as well as disseminations.

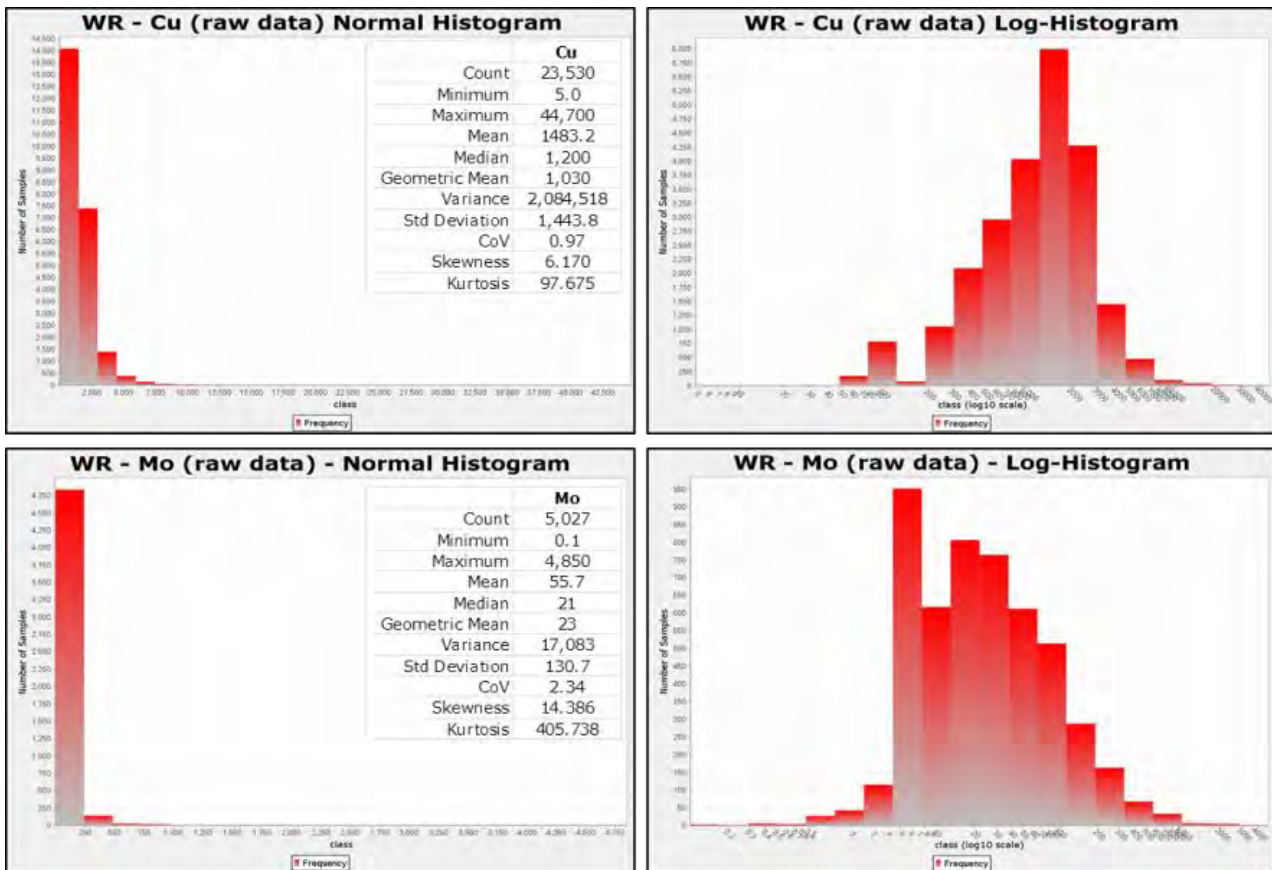

**Figure 11-5: Normal and log-histograms of the distribution of Cu within the WR along with the associated summary statistics.**

### 11.4.2 Grade versus Sample Width

Due to the fact that grade is not strictly additive; the relationship between a sample grade and the width/volume/tonnage it represents is a very important consideration. In some deposits, clear relationships (positive or negative) exist between grade and sample width and in these instances, it is more correct to work with the grade accumulation (grade x width or grade x volume etc.) than the actual grade. In this instance, the core diameter is assumed constant and a default density was to be applied so it made sense to only consider the grade and sample length relationship. A scatter plot of copper and molybdenum grade versus sample length is shown in Figure 11-6.

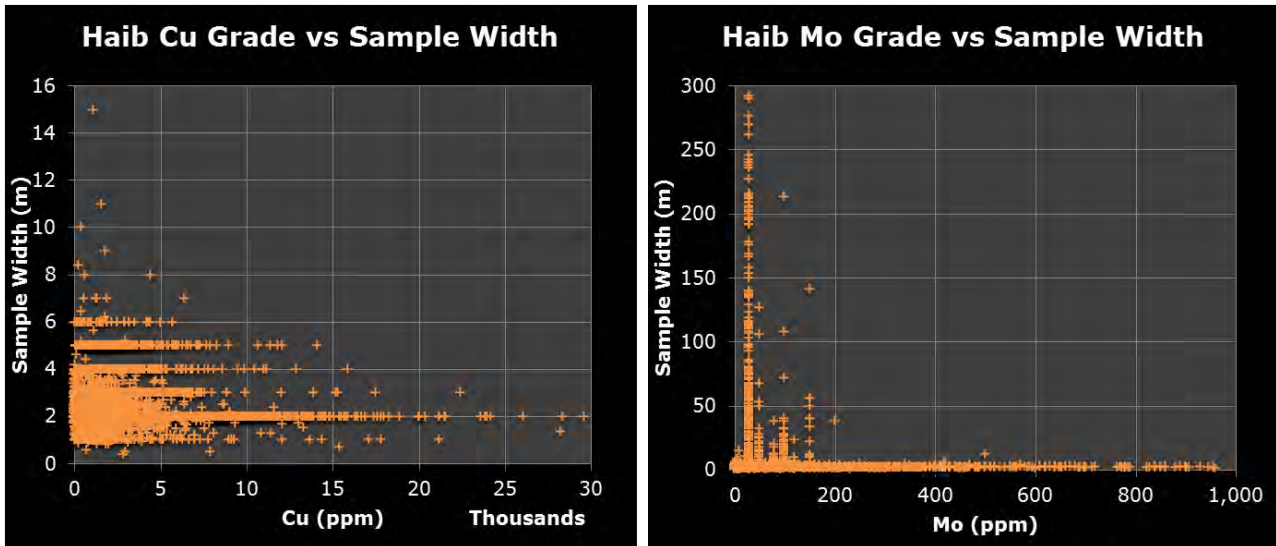

**Figure 11-6: Scatterplots for all raw samples comparing copper and molybdenum grade to sample width.**

It is clear from the figure above that there is no clear relationship between copper grade and sample width which is confirmed by a correlation co-efficient of 0.013 (calculated but not shown). As the sample size has no obvious effect on the grade, it was decided to continue with the mineral resource estimation work using the copper grades “as-is” and not accumulations. The same is true for the molybdenum grades and the same decision to work with molybdenum grades was taken.

### 11.4.3 Compositing

Within the portion of the prospecting area that had been modelled by Teck, the horizontal drill hole spacing closely approximates a grid of 150 x 150m. As most of the raw samples are between 1 and 2m wide, the vertical component of the sample spacing is very small relative to the horizontal components. Compositing is typically used to regularise the sample size to produce a standardised weight for each sample. However, in this instance, as the sample lengths are already fairly consistent it was decided to composite the samples to a more global scale better suited to the scale of open cast mining. A 10 m composite length was selected to correlate with a typical bench height and 10 m composites were calculated within the contacts of the MZ and WR starting from the collar. Residual composites were retained.

The univariate statistics were then calculated for copper and molybdenum for each of the MZ and WR and are presented in Figure 14-7 while the results are tabulated in Table 11-4. From Figure 11-7, it can be seen that the composite populations remain positively skewed with the copper showing a coefficient of variation of 0.51, indicating a greater normal distribution component especially for the MZ copper.

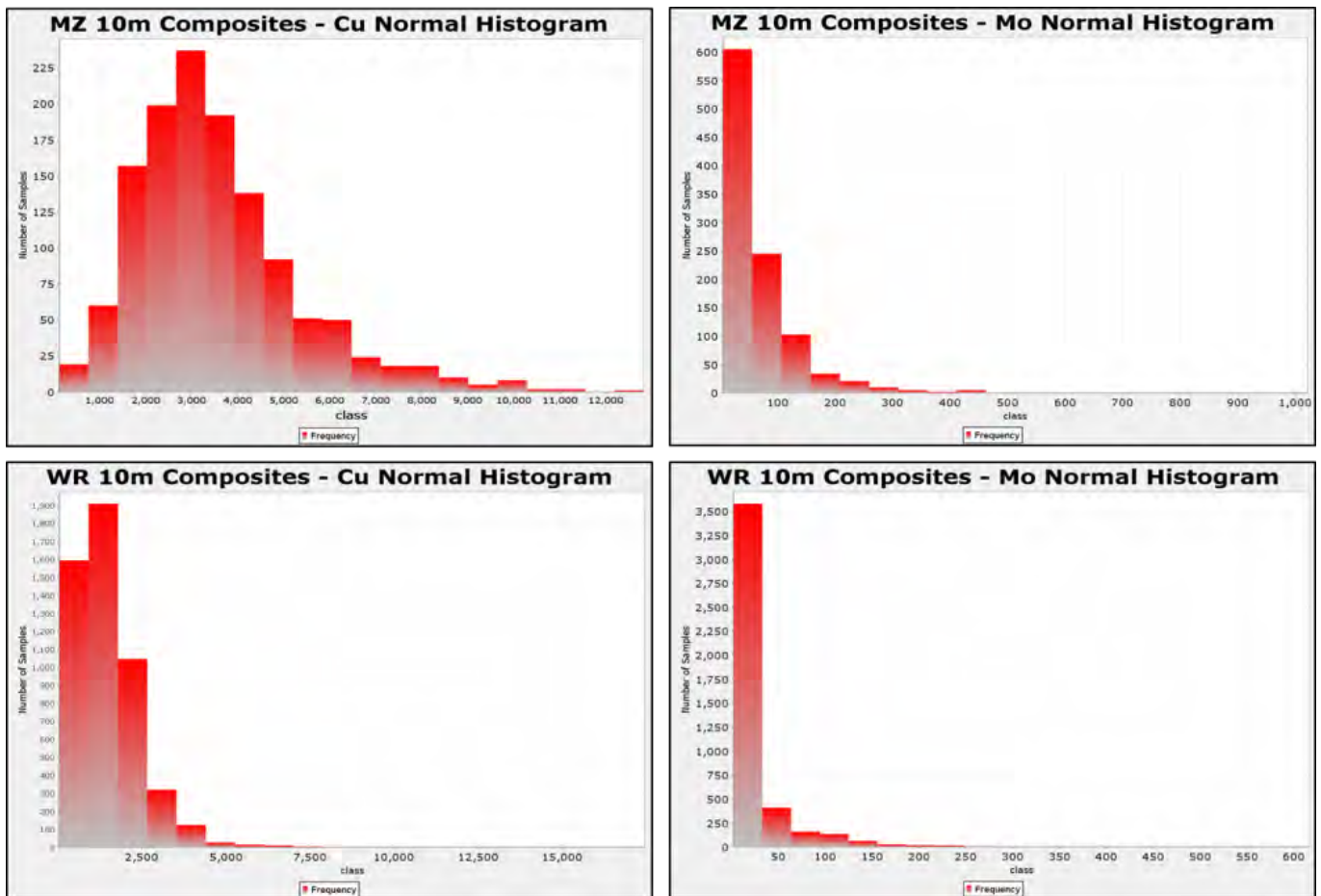
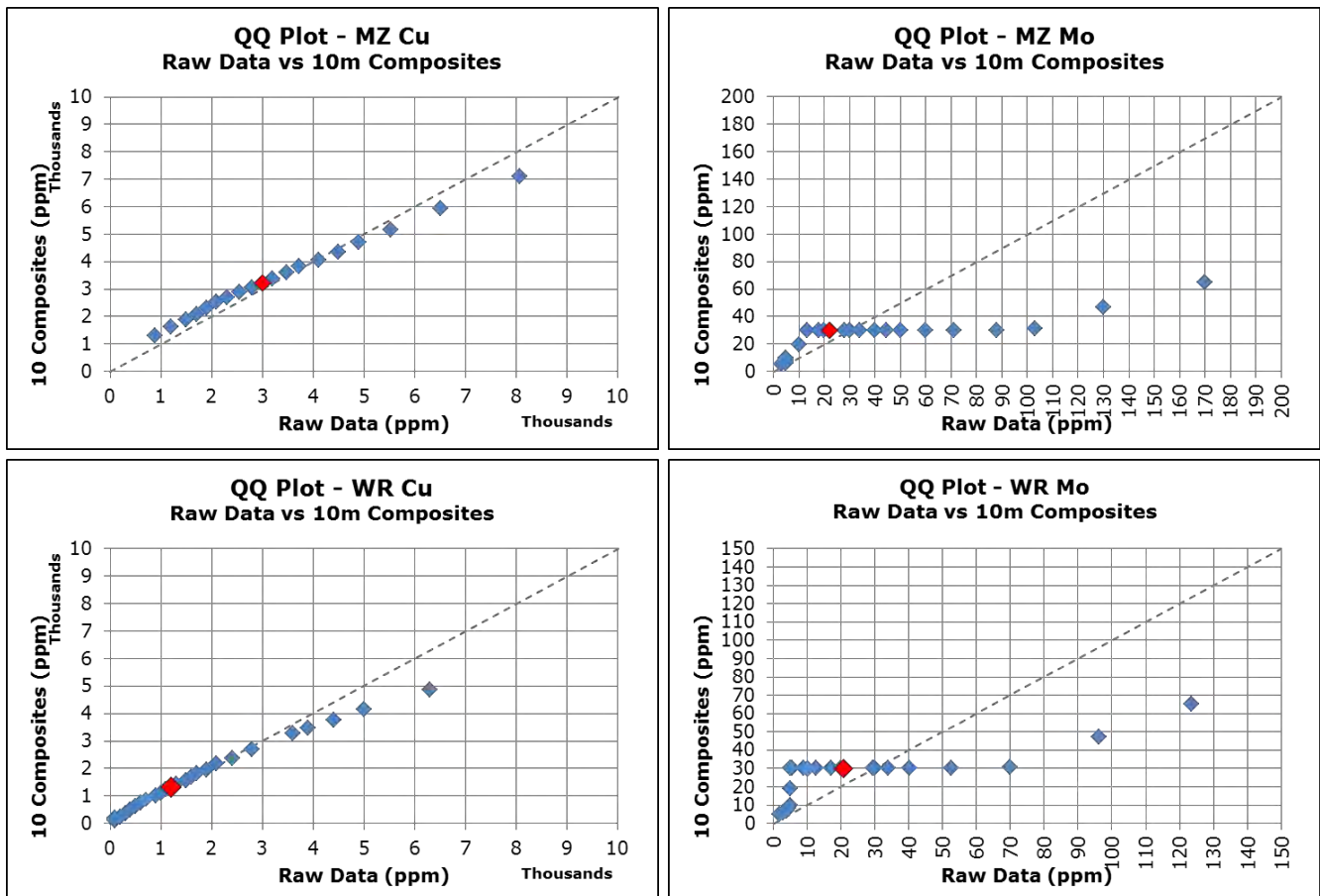

**Figure 11-7: Normal histograms showing the distribution of the 10m composite copper and molybdenum grades within the MZ and WR.**

**Table 11-4: Summary univariate statistics of the 10m composites by domain**

	MZ		WR	
	Cu	Mo	Cu	Mo
Count	1,283	1,034	5,067	4,448
Minimum	120.0	5.0	50.0	2.2
Maximum	12,820	1,022	17,480	617
Mean	3538.5	70.8	1485.0	39.8
Median	3,224	46	1,320	30
Geometric Mean	3,100	50	1,141	32
Variance	3,232,135	6,104	1,109,008	1,736
Std Deviation	1,797.8	78.1	1,053.1	41.7
CoV	0.51	1.10	0.71	1.05
Skewness	1.230	4.628	2.497	6.215
Kurtosis	5.195	39.859	21.364	59.754

Smoothing of grade is a natural consequence of compositing and care should be taken to avoid smoothing out all the natural variation of the grade. Creating 10 m composites from 1 to 2 m samples is quite an aggressive approach so the impact of the compositing was assessed. This was done using Quantile-Quantile (QQ) Plots to compare the percentile distributions of the raw and composited data. These are given in Figure 11-8.



**Figure 11-8: QQ Plots comparing by the domain, the copper and molybdenum grade distributions of the raw data against the derived 10m composites.**

On a QQ Plot, one expects to see the curve cross the dashed 45° line at the median or mean value (indication of bias) while the amount of rotation from the 45° line provides an assessment of the amount of smoothing that has occurred. From Figure 11-8, it can be seen that the effect of compositing on the copper distribution is negligible and the composites reflect a similar variation to the original data. For molybdenum, the situation is a little more complex but is almost certainly the result of the visually estimated molybdenum grades discussed further. It should also be remembered that molybdenum is of secondary importance to copper in this exercise.

#### **11.4.4 Molybdenum – Analysed Grades versus Visual Estimates**

To compensate for missing samples, some of the drillholes contain molybdenum grades that are based purely on analytical laboratory assays while for others the molybdenum grades are visual estimates. Visual estimates are subjective and their quality is a function of the skill and experience of the responsible geologist and can therefore result in biased datasets. In this instance, the assays represent some 9,324 samples while there are only 404 visual estimates, so the anticipated influence is small. The cumulative frequency distributions are presented in Figure 11-9.

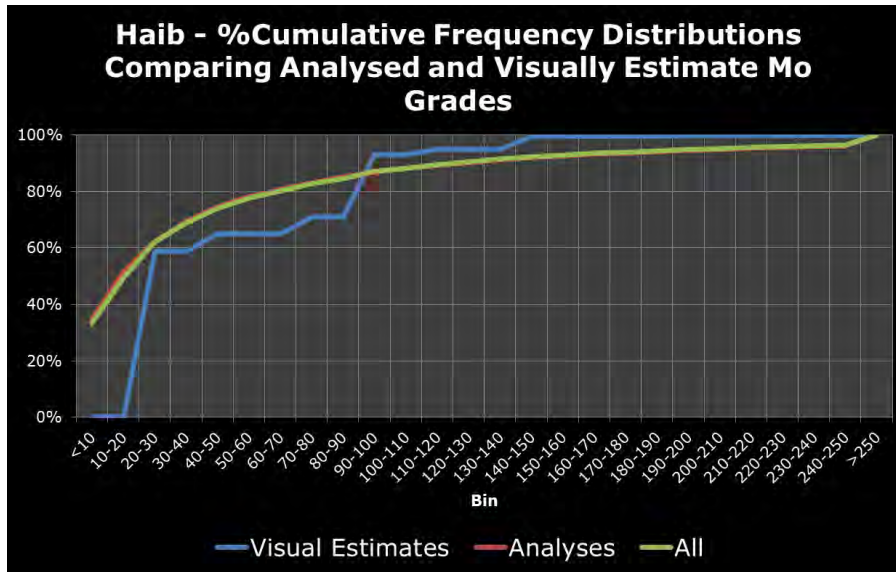

Figure 11-9: Cumulative frequency curves comparing the grade distributions of analysed molybdenum grades and visual estimates.

From the figure above, the following is evident:

- The distribution of the visual estimates crosses that of the analyses in such a manner that the relatively higher grade samples are offset by relatively more low grades. This is indicated by the areas between the blue and the red line.
- The distribution of all the molybdenum grades (visual estimate and analyses) is practically identical to that of the analyses. The visual estimates therefore do not materially bias the final compiled dataset.

A cautionary note is that the plot above does not consider sample length. The visual estimates are done for significantly larger intervals than the samples. If a 60 m visual estimate is composited into six 10 m samples, then this will impact the resultant cumulative frequency distribution. The effect of this is clearly demonstrated in the composite distributions in Figure 11-8 above for the molybdenum plots. While, it is expected that any positive bias will be offset by a negative effect, the molybdenum grades cannot be viewed at the same level of confidence as the copper grades and are essentially of secondary importance in this exercise.

## 11.5 Variography

In order to detect any preferred directions of grade continuity, variography was conducted for each of copper and molybdenum in the MZ and WR. This comprised linear semi-variograms to examine the Nugget Effect as well as omni-directional and directional experimental semi-



variograms. Anisotropy was determined and variogram models fitted for use in estimation by Ordinary Kriging.

#### **11.5.1 Linear Semi-variograms**

Experimental linear semi-variograms were generated down the hole using the raw data. As linear semi-variograms use the closest spaced samples they can provide a good indication of the degree of randomness (Nugget Effect) of a deposit. The experimental linear semi-variograms and the derived variogram models are shown in Figure 11-10. The variograms are very robust and are supported by a large number of sample pairs. Both show double spherical structures with the first sill between 16 and 20 m while the copper shows a range in excess of 500 m. The model curves represent an initial relative rapid change in continuity to the first sill at which the rate of change is more gradual. For copper, the Nugget Effect is about 40% of the population variance while for molybdenum it is at 76%.

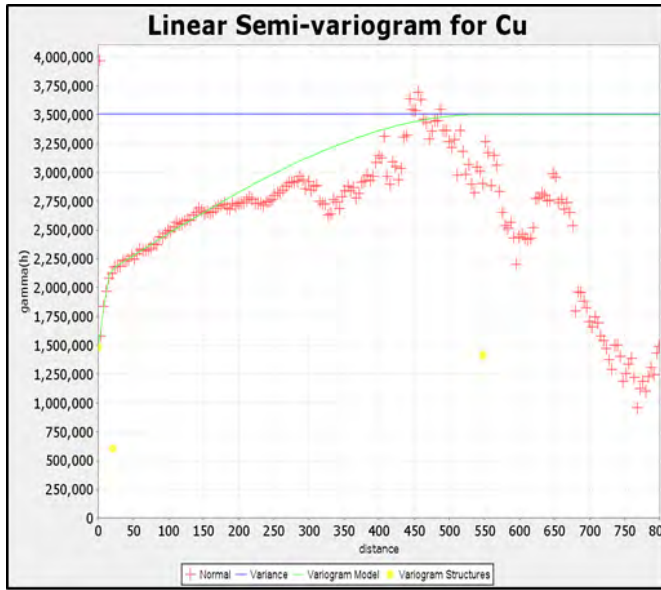

	Linear Semi-Variogram	
	Cu	Mo
<b>Model Type</b>	<i>Spherical</i>	<i>Spherical</i>
<b>C<sub>0</sub></b>	1,481,721	11,309
<b>% of Var</b>	42%	76%
<b>Sill<sub>1</sub></b>	604,313	1,143
<b>Cum% of Var</b>	60%	84%
<b>Range<sub>1</sub></b>	20	16
<b>Sill<sub>2</sub></b>	1,417,440	2,381
<b>Range<sub>2</sub></b>	548	104

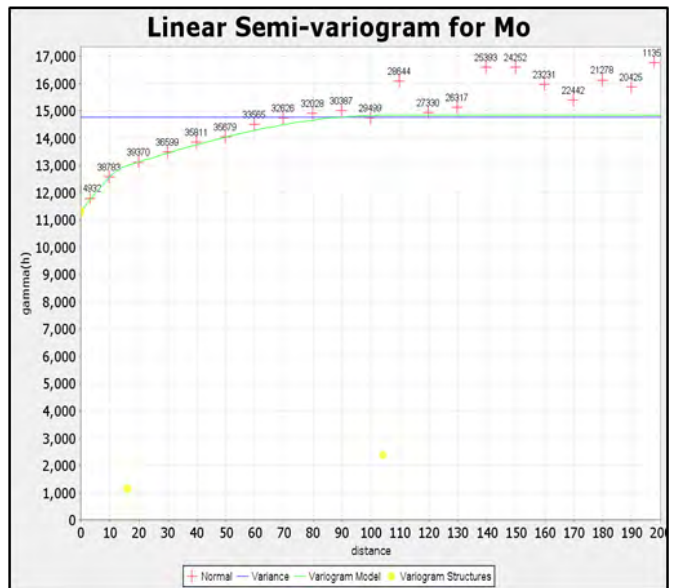

**Figure 11-10: Experimental linear semi-variograms for copper and molybdenum and the derived spherical models.**

### 11.5.2 Omni-directional Semi-variograms

These quantify the rate of change of grade continuity purely on the basis of distance only without any considerations of anisotropy. Robust spherical variogram models were obtained for all parameters considered. In some instances, outliers were filtered out of the experimental variograms to reduce noise. Models were fitted in this space then back transformed to the original population space. The variogram models are summarised in Table 11-5.

All elements considered could be modelled using a double spherical structure. The largest ranges were obtained for WR at ~1,200 m and 560 m for copper and molybdenum respectively. The nugget for copper is at ~30% of the population variance while molybdenum is between 36% and 55%. All elements reach the first sill at similar levels relative to the population variance.

**Table 11-5: Derived omni-directional variogram models for copper and molybdenum by domain**

<b>Model Type</b>	<b>Omni-Directional Semi-Variogram Models</b>			
	<b>MZ</b>		<b>WR</b>	
	<b>Cu</b>	<b>Mo</b>	<b>Cu</b>	<b>Mo</b>
	<i>Spherical</i>	<i>Spherical</i>	<i>Spherical</i>	<i>Spherical</i>
<b>C<sub>0</sub></b>	1,079,916	2,185	657,477	1,448
<b>% of Var</b>	33%	36%	29%	55%
<b>Sill<sub>1</sub></b>	1,353,944	1,821	1,126,183	880
<b>Cum% of Var</b>	75%	66%	79%	88%
<b>Range<sub>1</sub></b>	34	66	263	230
<b>Sill<sub>2</sub></b>	798,276	2,098	477,570	311
<b>Range<sub>2</sub></b>	203	378	1,215	560

### 11.5.3 Directional Semi-variograms

While very well supported omni-directional variogram models were obtained, one of the drawbacks of omni-directional variograms is that they can often obscure finer scaled details. Additionally, in this instance the mineralisation has a definite component of structural control with an association with veins and fractures. For these reasons, any existing potential preferred orientation of grade continuity was tested using directional semi-variograms.

The derived directional semi variogram models are shown in Figure 11-11. The maximum continuity is shown by the yellow lines while the subordinate anisotropy axes are indicated by the magenta and cyan lines. These show a general anisotropy where the semi-major axis has a Range of ~50% of the major axis and the minor about 25%. The WR molybdenum is one exception where the major and semi major anisotropy components are very similar.

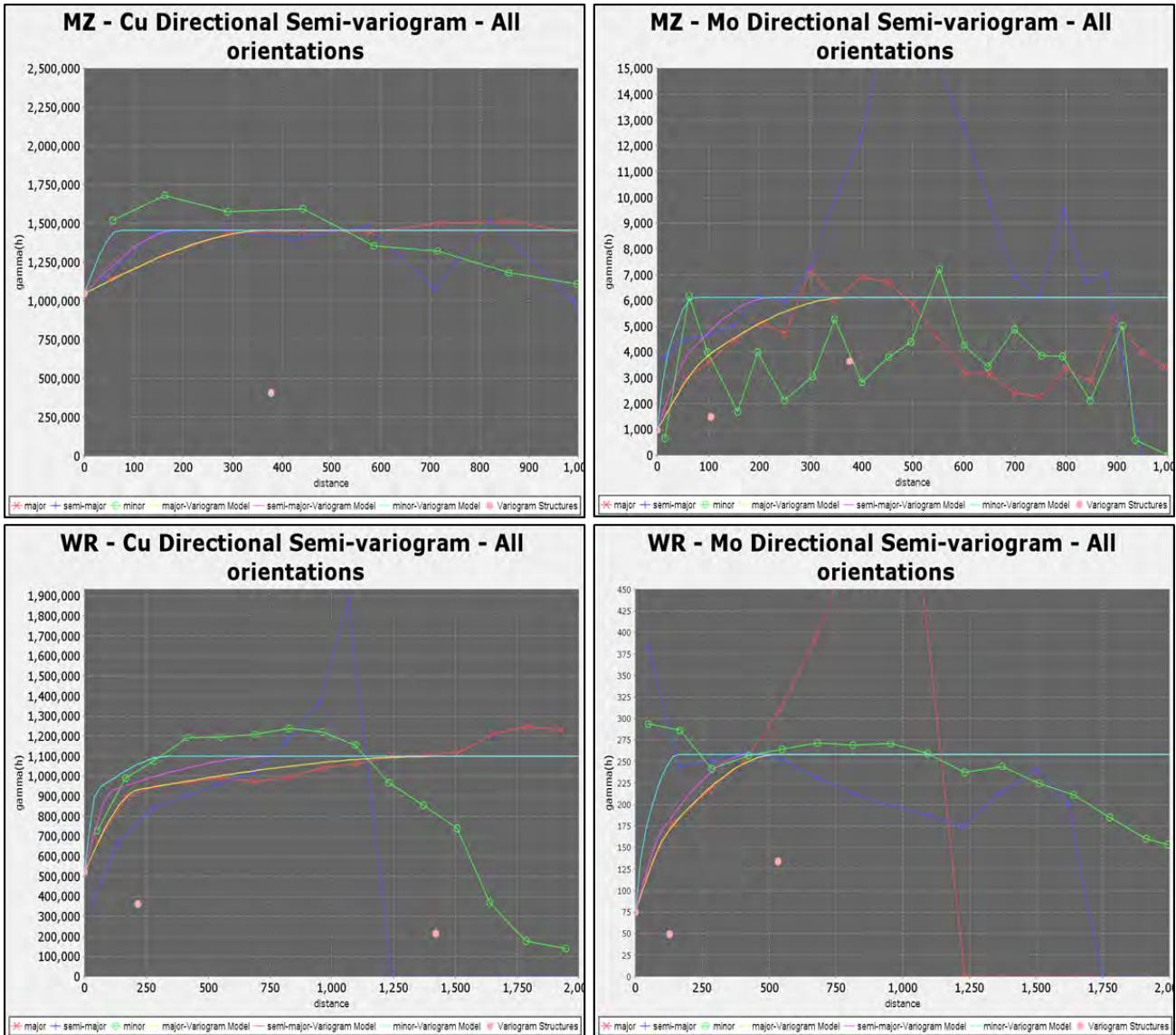

**Figure 11-11: Directional semi-variograms showing the “All Orientations” variogram models for copper and molybdenum in the MZ and WR.**

The variogram models are summarised in Table 11-6. For copper in the MZ, the model shows a single spherical structure with a maximum Range of just under 400 m. For WR, the copper shows a double spherical structure, the first with a Range just over 200 m and a maximum Range of 1,420. For molybdenum in both domains, the models are relatively similar.

**Table 11-6: Derived variogram models and their associated anisotropy components for copper and molybdenum in the MZ and WR.**

		MZ		WR		
		Cu	Mo	Cu	Mo	Mo <sup>omni</sup>
	<b>Model Type</b>	<i>Spherical</i>	<i>Spherical</i>	<i>Spherical</i>	<i>Spherical</i>	<i>Spherical</i>
	<b>C<sub>0</sub></b>	2,328,046	983	1,073,898	766	1,488
	<b>% of Var</b>	72%	16%	47%	29%	55%
	<b>Sill1</b>	904,089	1,491	744,247	505	897
	<b>Cum% of Var</b>			80%	48%	33%
	<b>Range1</b>	378	105	215	127	230
	<b>Sill2</b>		3,646	443,085	1,369	311
	<b>Range2</b>		376.8	1,420	534	560
<b>Anisotropy</b>	<b>Plunge</b>	0.0	20.5	0.0	64.5	-
	<b>Bearing</b>	169.2	170.9	134.7	207.1	-
	<b>Dip</b>	66.8	89.5	67.2	-77.9	-
	<b>Major:semi-major</b>	1.78	1.68	1.87	1.24	-
	<b>Major:minor</b>	5.36	5.18	4.15	3.36	-

At this stage, the decision was made to use the directional variogram models in Table 11-6 further because they showed larger maximum ranges than the omni-directional variograms and also were considered more representative of the mineralisation style which shows a degree of anisotropy. The one exception was for molybdenum in the WR. The omni-directional variogram was more robust than the directional variogram and has about the same Range. For this reason, the omni-directional variogram was used instead and is provided above in Table 11-6.

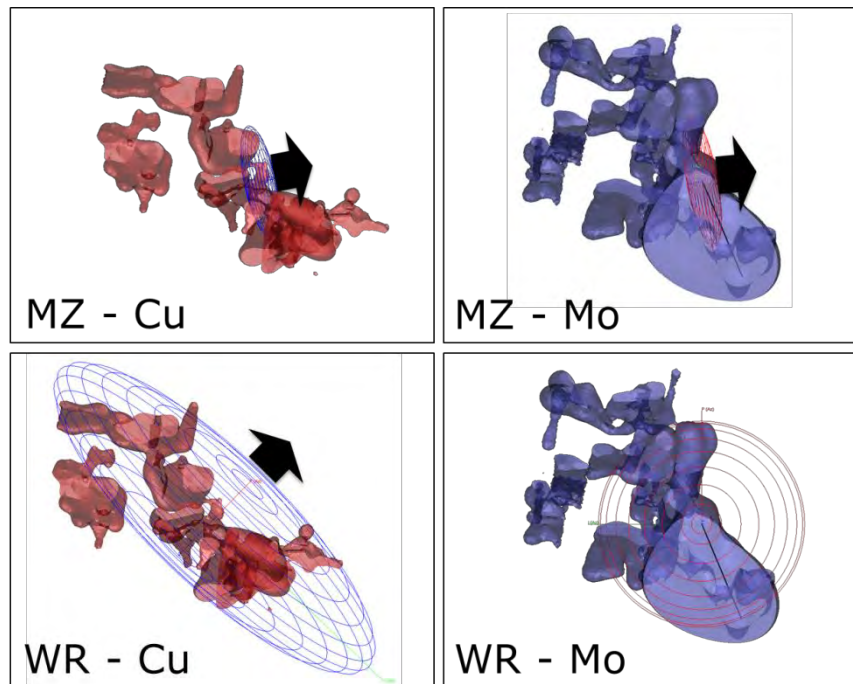

**Figure 11-12: Isometric views showing the selected variogram anisotropy relative to the 3D models, MZ for copper and the molybdenum isoshell for molybdenum**

The anisotropy ellipsoids are shown in Figure 11-12 where the black arrow indicates the direction of dip of the ellipsoid. In the case of copper, the MZ model is shown while for molybdenum, the high-grade molybdenum isoshell from LeapFrog is shown.

## 11.6 Block Modelling

The general mine planning software, Geovia-GEMS from Dassault Systems was used for this work. GEMS makes use of a Percent block model attribute and not sub-celling to manage and report volume accurately. The cell size used in the estimation in GEMS is therefore purely a function of the data spacing. For this work, it was felt that a full Quantitative Kriging Neighbourhood Analysis (QKNA) was un-warranted due to the fact that the drilling is relatively evenly spaced and the derived variogram models are robust and supported by a large number of sample pairs. Any gains from the QKNA are likely to be minor and wouldn't be substantiated by the amount of work required.

Instead, a horizontal cell size of 75 m x 75 m was used as the drillholes are spaced on a grid with a general spacing of 150 m x 150 m. A cell height of 10m was selected.

The block model project was positioned over the area modelled and sized appropriately to cover the full extent of the modelling. The geometrical definitions are given in Table 11-7.

**Table 11-7: Block model geometrical definitions**

<b>Origin</b>	X	780,140
	Y	6,821,810
	Z	650
<b>Cell Size</b>	Column	75
	Row	75
	Level	10
<b>No. of Cells</b>	Columns	39
	Rows	31
	Level	115
<b>Length</b>	X Direction	2,925
	Y Direction	2,325
	Z Direction	1,150

### 11.7 Density

No density determinations were received as part of this work and it is not known if in fact any have been done. In the absence of these, it was decided to apply a default density appropriate for the geological terrane of 2.8 t/m<sup>3</sup> for both the MZ and WR. While this level of detail for density is sufficient for a pre-feasibility level study, in order for more detailed studies, density determinations will be required.

### 11.8 Estimation

Ordinary Kriging was used to estimate copper and molybdenum for each of the MZ and WR. Kriging was done in a stepwise fashion as follows:

- A first pass Kriging run was done using a search ellipse matched to the anisotropic Ranges (if applicable) of the semi-variogram models. Cells estimated during the first pass were tagged with an integer value of 1.
- The search ellipsoid axes ranges were then doubled, the minimum and maximum number of samples adjusted and a 2nd Kriging run was done. Cells populated were tagged with the value 2.
- For the 3rd run, the search was opened to populate the remaining cells usually <11% of the total cells.
- For the copper estimates, an octant search was used while for molybdenum an ellipsoid search was used. The anisotropy component for copper is stronger than molybdenum therefore it was felt the octant search offered better control of this aspect during estimation.

- Grade capping and cutting were utilised. A maximum high grade limit (HGL) was set whereby all values exceeding this value were adjusted to this high-grade limit. A high-grade transition (HGT) value was also defined. All values between the HGT and HGL were used “as-is” but the range of influence for these was significantly reduced.

A summary of the Kriging run inputs is given in Table 11-8.



**Table 11-8: Summary of the kriging inputs for each of the runs completed for copper and molybdenum in the MZ and the WR.**

		MZ		WR	
		Cu	Mo	Cu	Mo
Run 1	Search	RANGE	RANGE	RANGE	RANGE
	Minimum Samples	10	10	10	10
	Maximum Samples	18	18	18	18
	Discretisation	10x10x5	10x10x5	10x10x5	10x10x5
	Search Type	Ellipsoidal	Ellipsoidal	Octant	Ellipsoidal
	Min. Octants	-	-	4	-
	Max. Samples per Octant	-	-	5	-
	High Grade Transition (HGT)	9,000	300	6,000	128
	Range for >HGT	50; 30; 10	50; 30; 10	50; 27; 12	50; 50; 50
	High Grade Limit (HGL)	7,100	-	11,000	-
	Value for Samples >HGL	7,100	-	11,000	-
	No. of Cells Estimated	5,264	4,814	63,434	58,782
	Estimates Cells as %	64%	58%	59%	54%
Run 2	Search	RANGEx2	RANGEx2	RANGEx2	RANGEx2
	Minimum Samples	10	14	10	10
	Maximum Samples	18	20	18	18
	Discretisation	10x10x5	10x10x5	10x10x5	10x10x5
	Search Type	Ellipsoidal	Ellipsoidal	Ellipsoidal	Ellipsoidal
	Min. Octants	-	-	-	-
	Max. Samples per Octant	-	-	-	-
	High Grade Transition (HGT)	9,000	300	6,000	128
	Range for >HGT	50; 30; 10	50; 30; 10	50; 27; 12	50; 50; 50
	High Grade Limit (HGL)	7,100	-	11,000	-
	Value for Samples >HGL	7,100	-	11,000	-
	No. of Cells Estimated	2,438	2,575	44,569	41,385
	Estimates Cells as %	30%	31%	41%	38%
Run 3	Search	<i>Opened</i>	<i>Opened</i>	<i>Opened</i>	<i>Opened</i>
	Minimum Samples	12	14	10	10
	Maximum Samples	18	24	18	18
	Discretisation	10x10x5	10x10x5	10x10x5	10x10x5
	Search Type	Ellipsoidal	Ellipsoidal	Ellipsoidal	Ellipsoidal
	Min. Octants		-	-	-
	Max. Samples per Octant		-	-	-
	High Grade Transition (HGT)	9,000	300	6,000	6,000
	Range for >HGT	50; 30; 10	50; 30; 10	50; 27; 12	50; 27; 12
	High Grade Limit (HGL)	7,100	-	11,000	11,000
	Value for Samples >HGL	7,100	-	11,000	11,000
	No. of Cells Estimated	537	850	155	-100,167
	Estimates Cells as %	6%	11%	0%	8%

During kriging, various outputs such as kriging variance, kriging efficiency, slope of regression, number of samples, number of negative weights and others were tracked and used as a guide in the estimation process.

### 11.9 Estimate Validations

During kriging, various parameters were tracked and trace blocks were used in regions of high, medium and low data support. Post-estimation, visual inspection was used along with more quantitative methods such as:

- Non-spatial comparison of source data and estimates using QQ Plots;
- Swath lots were generated to compare trends in the data and estimates.

### 11.9.1 QQ Plots

The Quantile-Quantile Plots comparing the percentile distributions of the 10 m composite source data to the estimates are shown in Figure 11-13. Smoothing is a consequence of estimation and as expected; some smoothing is reflected by the rotation of the curves from the dashed 45° line. For the WR copper the estimate distribution is lower grade than that of the source data. This is almost certainly due to the fact that the WR domain extends beyond the data limits (particularly with depth). In these areas, grades are lower but also a lot of cells will be populated by only a portion of the source data. As the QQ Plot is non-spatial, it cannot really account for this. Nevertheless, the fact that the estimates are slightly lower grade does imply a more conservative result and it is the opinion of the author that these results are a good representation of the source data.

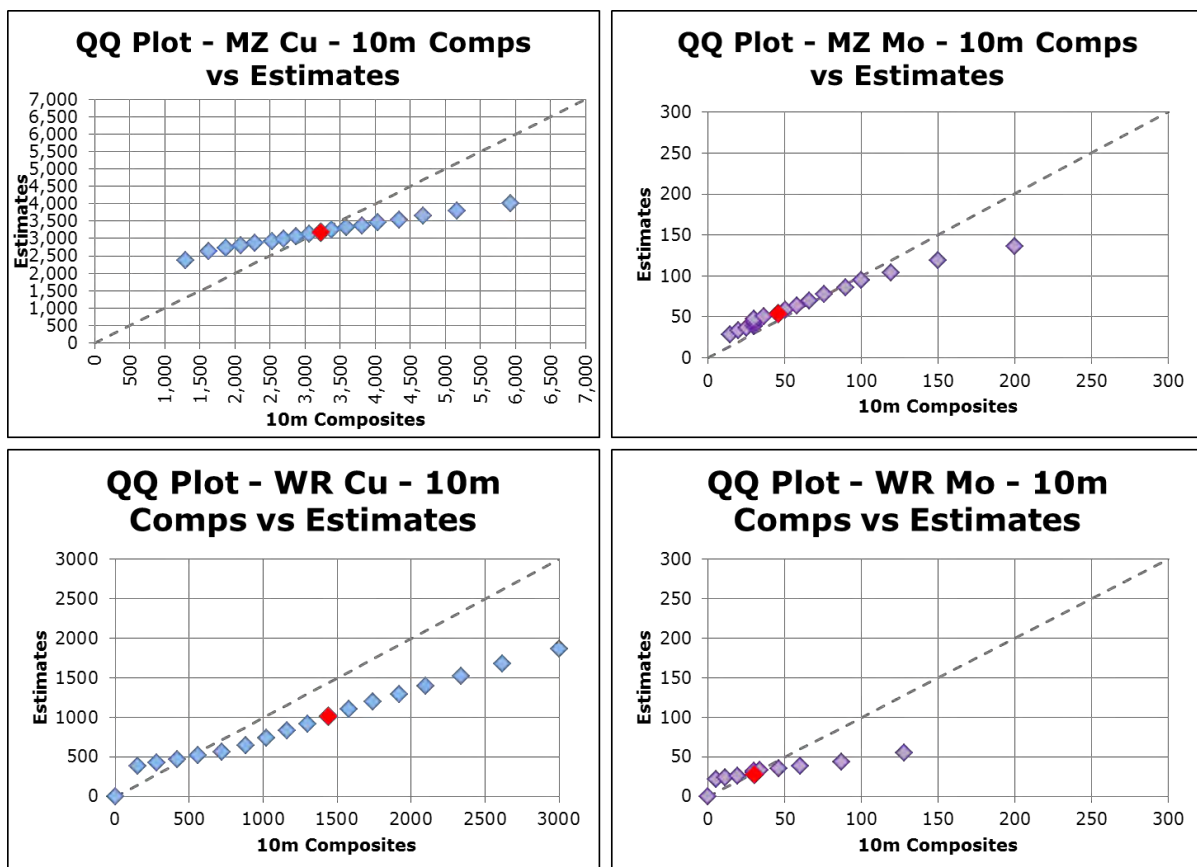
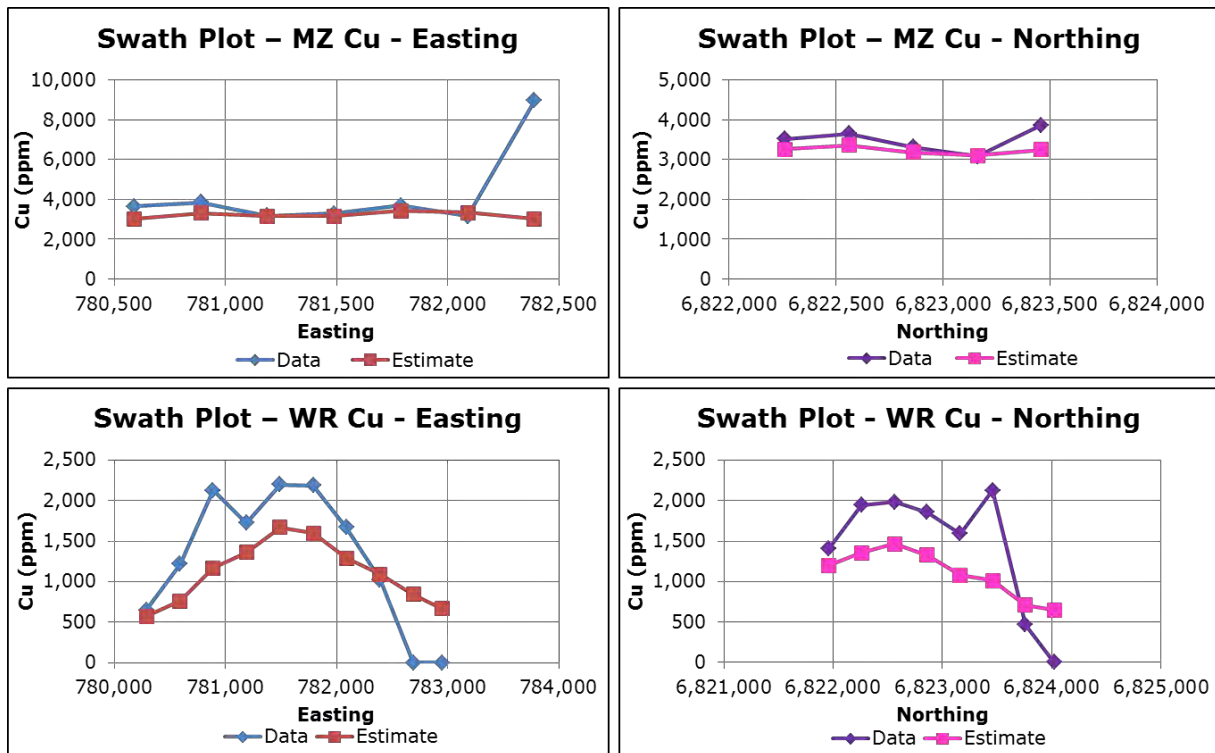

Figure 11-13: Isometric views showing the selected variogram anisotropy relative to the 3D models, MZ for copper and the molybdenum isoshell for molybdenum.

### 11.9.2 Swath Plots

Swath plots involve the aggregation and calculation of average grades of samples and estimates along pre-defined corridors orientated along the X, Y and Z axes of the block model. As they are aggregations, they are used to test whether data trends are reflected in the estimates e.g. Areas with high grade samples are associated with high grade estimate

values. The generated swath plots for copper are shown in Figure 11-14 where it can be clearly seen that the estimate and data trends show good correlation.



**Figure 11-14: Swath plots showing horizontal trends in source 10m composites and the estimates of copper.**

### 11.10 Mineral Resource Classification

The mineral resource estimates presented here have been classified according to the guidelines of the Canadian National Instrument 43-101 by Dean Richards of Obsidian Consulting Services, who is an appropriate Qualified Person as defined by the instrument. The definitions applied from the code were as follows:

#### Mineral Resource

A Mineral Resource is a concentration or occurrence of solid material of economic interest in or on the Earth's crust in such form, grade or quality and quantity that there are reasonable prospects for eventual economic extraction.

The location, quantity, grade or quality, continuity and other geological characteristics of a Mineral Resource are known, estimated or interpreted from specific geological evidence and knowledge, including sampling.

### **Inferred Mineral Resource**

*An Inferred Mineral Resource is that part of a Mineral Resource for which quantity and grade or quality are estimated on the basis of limited geological evidence and sampling. Geological evidence is sufficient to imply but not verify geological and grade or quality continuity.*

*An Inferred Mineral Resource has a lower level of confidence than that applying to an Indicated Mineral Resource and must not be converted to a Mineral Reserve. It is reasonably expected that the majority of Inferred Mineral Resources could be upgraded to Indicated Mineral Resources with continued exploration.*

### **Indicated Mineral Resource**

*An Indicated Mineral Resource is that part of a Mineral Resource for which quantity, grade or quality, densities, shape and physical characteristics are estimated with sufficient confidence to allow the application of Modifying Factors in sufficient detail to support mine planning and evaluation of the economic viability of the deposit.*

*Geological evidence is derived from adequately detailed and reliable exploration, sampling and testing and is sufficient to assume geological and grade or quality continuity between points of observation.*

*An Indicated Mineral Resource has a lower level of confidence than that applying to a Measured Mineral Resource and may only be converted to a Probable Mineral Reserve.*

### **Measured Mineral Resource**

*A Measured Mineral Resource is that part of a Mineral Resource for which quantity, grade or quality, densities, shape, and physical characteristics are estimated with confidence sufficient to allow the application of Modifying Factors to support detailed mine planning and final evaluation of the economic viability of the deposit.*

*Geological evidence is derived from detailed and reliable exploration, sampling and testing and is sufficient to confirm geological and grade or quality continuity between points of observation.*

*A Measured Mineral Resource has a higher level of confidence than that applying to either an Indicated Mineral Resource or an Inferred Mineral Resource. It may be converted to a Proven Mineral Reserve or to a Probable Mineral Reserve.*

The types of data, data density and the distribution for Haib are such that they provide a good basis for the confident interpretation of the geology and mineralisation constraints of the Haib deposit. The drillhole spacing and the quantity of data has allowed the grade continuity to be well defined at distances much smaller than the Ranges expressed by the

variography. While a significant portion of the data was not subjected to an international standard Quality Assurance and Quality Control programme, the most recent work completed by Teck was significant and as it sampled largely the same domain as the historical work, it provides a means of establishing the quality of the historic data. These show that for the MZ, the two distributions of the historic and the Teck data are practically identical for copper. For the WR, a slight bias is indicated with the Teck grade distribution being slightly lower than the historic data but it is the CP's opinion this difference is not material.

With respect to the molybdenum grades reported here, they do not provide the confidence levels that the copper grades do and the resource classification is based purely on the copper grade.

For the above reasons, the following classification has been applied. No Measured Mineral Resources can be declared for Haib at this stage. For the MZ, the drilling density is quite high to an elevation of approximately 75 m above mean sea level. Below this, the spacing increases. The portion of the MZ mineral resource from surface to ~75 m elevation is classified as an Indicated Mineral Resource, while that below is considered Inferred (Figure 11-15). As the entire MZ model lies within the limits of the drilling no artificial constructs were required to limit its horizontal extent.

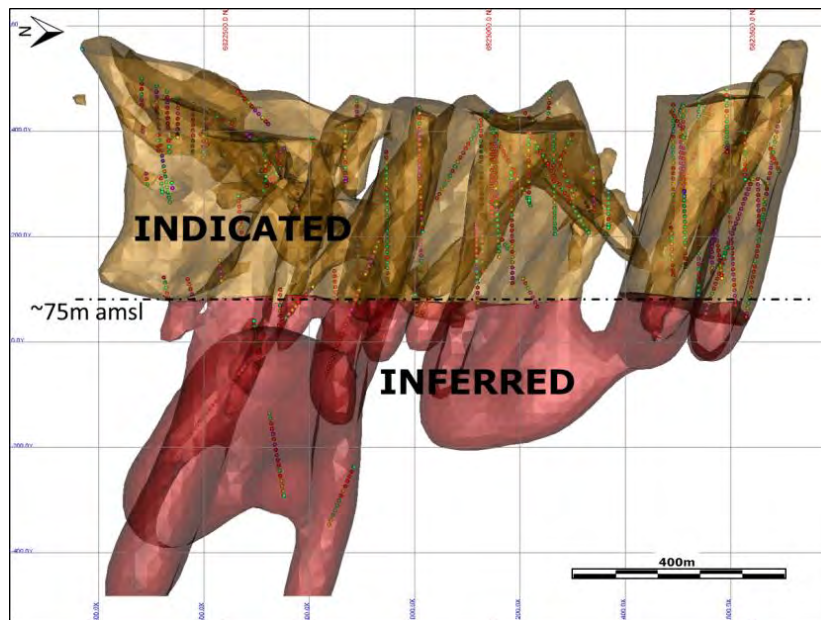
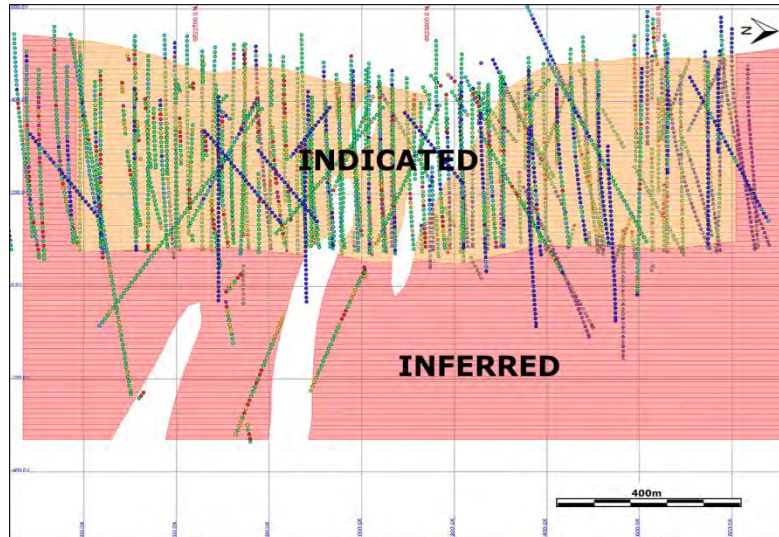

**Figure 11-15: Vertical section looking westwards showing the mineral resource classification of the MZ along with sample positions.**

The data support for the WR is different and the model extends beyond the limits of drilling. The data density is high to ~75 m elevation below which the spacing opens significantly. For the WR, Indicated Mineral Resources have been defined as the volume wholly within the last

line of drillholes in all orientations down to a depth of ~75 m elevation (Figure 11-16). Inferred Mineral Resources are to the elevation of the deepest drillhole intersection at -330 m elevation. Laterally, the Inferred boundary has been expanded 100 m from the last line of drillholes. As variogram Ranges are significantly larger than 100 m and the copper anisotropy is well defined, this is considered a reasonable interpolation.

The Indicated Mineral Resources for both the MZ and the WR are suitable for use in a Pre-Feasibility level study.



**Figure 11-16: Vertical section looking westwards showing the mineral resource classification of the WR along with sample positions.**

### 11.11 Mineral Resources Statement

Bearing in mind the codes requirement for a mineral resource to be of “such form, grade or quality and quantity that there is reasonable prospects for eventual economic extraction”, a cut-off grade of  $\geq 0.2\%$  copper has been applied in the compilation of the Haib Mineral Resources Statement presented in Table 11-9. It must be highlighted again that the confidence in the reported molybdenum grades is significantly lower than copper and only the copper grades have been used in the classification. The molybdenum grades reported in Table 11-9 are provided for illustrative reasons only.

**Table 11-9: Classified mineral resources**

Zone	Resource Class	Volume (xMillion m <sup>3</sup> )	Density	xMillion Tonnes	Cu(%)	Mo(ppm)
<b>MZ</b>	Measured	-	-	-	-	-
	Indicated	80.3	2.8	224.8	0.32	60
	<b>M+I</b>	<b>80.3</b>	<b>2.8</b>	<b>224.8</b>	<b>0.32</b>	<b>60</b>
	Inferred	47.4	2.8	132.8	0.34	79
<b>WR</b>	Measured	-	-	-	-	-
	Indicated	138.2	2.8	387.1	0.23	41
	<b>M+I</b>	<b>138.2</b>	<b>2.8</b>	<b>387.1</b>	<b>0.23</b>	<b>41</b>
	Inferred	154.5	2.8	432.5	0.22	48
<b>Total</b>	Measured	-	-	-	-	-
	Indicated	218.5	2.8	611.9	0.26	48
	<b>M+I</b>	<b>218.5</b>	<b>2.8</b>	<b>611.9</b>	<b>0.26</b>	<b>48</b>
	Inferred	201.9	2.8	565.3	0.25	157

*Rounding has been applied as appropriate to reflect limits of precision and accuracy*

It can be seen from Table 11-9 that the Haib Copper Project is a large tonnage but relatively low copper grade deposit which correlates with the mineralisation model. Nevertheless, there are some higher grade areas within both the MZ and even the WR. Figure 11-17 shows some Grade/Tonnage curves for the MZ and WR to demonstrate this.

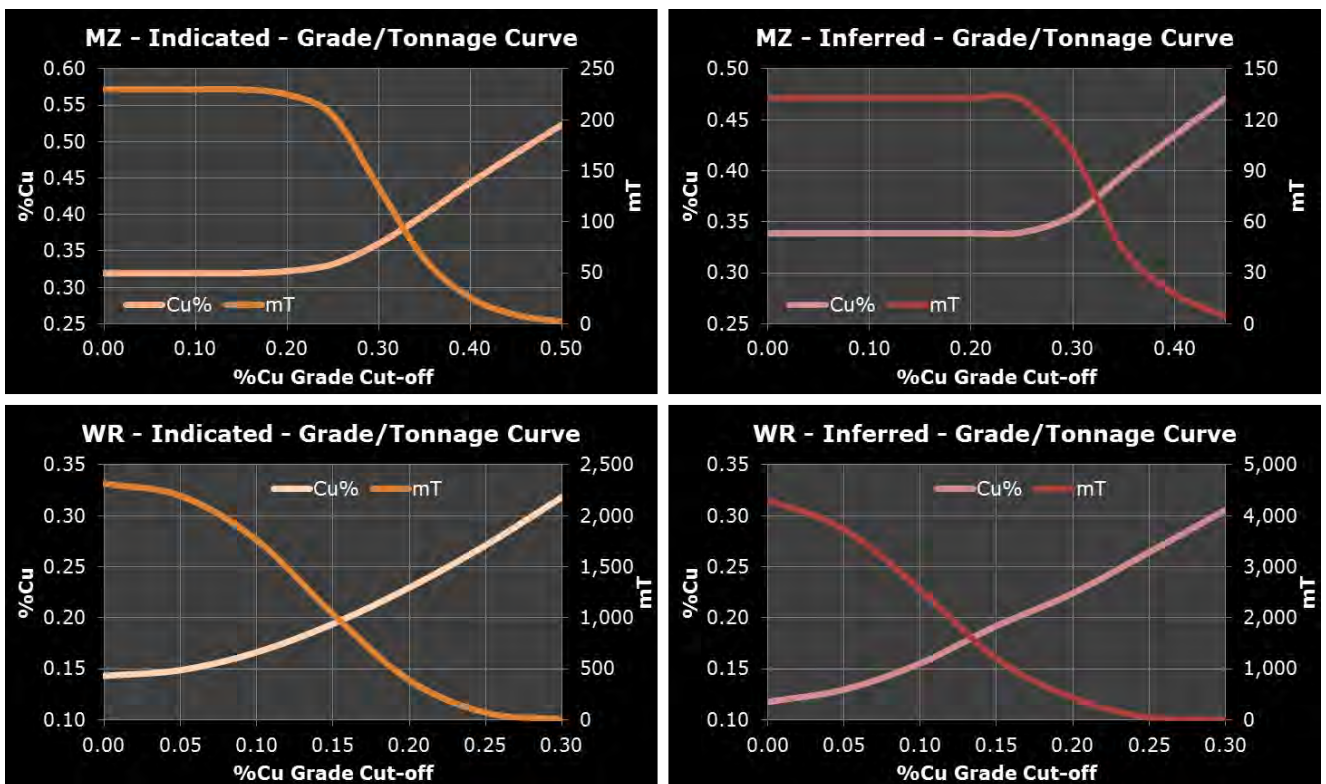

**Figure 11-17: Copper grade/tonnage curves for the MZ and WR.**

## **12. MINING METHODS**

### **12.1 Introduction**

Considering the Haib copper deposit characteristics, the suitable mine design is based on an open pit method. As the deposit is basically composed by hard rock material, the mining operations will involve drill and blast of all excavated material, which will be segregated by cut-off grade.

The mining fleet considered being suitable for the Haib project would most likely consist of between 80 t and 120 t sized hydraulic excavators, off highway dump trucks with a capacity of between 65 t to 90 t, supported by standard open-cut drilling and auxiliary equipment.

### **12.2 Geotechnical Review**

#### **12.2.1 Pit Slope Assessment**

A further geotechnical evaluation of the Haib copper deposit is essentially demanded because it is an integral component of any proposed mine or mining project. Parameters established by geotechnical study are fundamental for strategic mine planning and effective technical guidance of the mining operations.

#### **12.2.2 Excavation Characteristics**

In terms of the excavation characteristics, even though there is no geotechnical study of the deposit, the current information indicates that drilling and blasting is needed for all excavated material.

### **12.3 Groundwater Investigation**

There is no detailed ground water study of the Haib copper deposit area. The Orange River flows about 15 kilometres south of the main deposit, located in the extreme south of Namibia, where the average annual rainfall is 25-50 mm.

### **12.4 Proposed Mining Operation**

#### **12.4.1 Introduction**

Initial analysis involved mining approximately 8.5 Mtpa of ore. There is no estimate of the amount of waste that will be mined in the project.



#### **12.4.2 Open Pit Work Roster**

It is suggested to the mining operations to work 365 days in a year, less unscheduled delays such as high rainfall events which may cause mining operations to be temporarily suspended, which is high unlikely to happen considering that average annual rainfall is extremely low, especially in the deposit area.

There are numerous types of rosters, but it can be suggested one in which the mine workforce will operate on a two shift, three panel roster, seven days a week, in two 11 hour working shifts with the equipment services scheduled as required.

For example, a six and three (6/3) roster could be considered, which would equate to 6 days on day shift, 3 days off, 6 days on night shift, 3 days off.

The crushing plant is assumed to operate continuously except for planned maintenance periods.

#### **12.4.3 Bench Design**

The height of the mining benches is usually determined according to physical characteristics of the mineralisation and its impact on selectivity and dilution control.

Both mineralised material and waste could be drilled and blasted on standard 5 m benches for primary crusher feed and possibly 10 m benches for waste, and then mined by hydraulic excavators; nominally ranging from two 3 m high faces to three 4m high faces, taking into account blast induced swell, into rear dump and off highway haul trucks. The number of flitches to mine a bench will be dependent on the selectivity required and the size of the excavator used.

#### **12.4.4 Drill and Blast**

Rock fragmentation will be undertaken by drilling and blasting and its parameters will be based on the rock characteristics obtained during the geotechnical investigation, which will provide information of weathered and fresh material.

The blast pattern is dictated by the powder factor required to ensure appropriate fragmentation and heave. The selection of the powder factor will be based on the UCS (Unconfined Compressive Strength) measurement results obtained from the preliminary excavation characterisation work.

#### **12.4.5 Load and Haul**

There is no estimative yet of the total material movement at the project. However, considering the amount of ROM to be processed it is most likely that the ore will be directly

dipped into the ROM feed bin and likely to be proposed by contract miner using a combination of 220 t and 360 t off-highway dump trucks.

The high grade ore will be transported by trucks to the run-of-mine (ROM) stockpile, which will be near by the primary crusher. The distance between the pit and the plant will be established considering further topographic studies and the final mine pit design.

#### **12.4.6 Stockpiling and Reclaiming**

It is suggested that the material which does not match with the quality standard grade and is unable to be directly dumped into the crushing circuit be placed in an appropriate stockpile for processing at a later time if it is profitable.

The ROM will be stockpiled directly adjacent to the primary crusher and rehandled with a wheel loader that will dump material into a ROM bin, which feeds the gyratory cone crusher.

#### **12.4.7 Pit Dewatering and Drainage**

In the extreme south of Namibia, in summer the rainfall is associated with occasional thunder storms and is of short duration, but can be of very high intensity. Due of that, engineered surface water management structures are suggested to minimize effects of storm water run-on to critical mine facilities and to control the release of mine-impacted water to the environment.

### **12.5 Contract Mining**

It is generally not economic for a mine operator to undertake all of the functions required in the development and operation of a mine. Contractors are usually engaged when funds are not available for equipment purchase, the duration of the task is short, specialist skills are required and/or specialised equipment is involved.

Contractors can be effectively utilised to overcome unavoidable peaks in production required to maintain the mining schedule. For example, an open cut may have a large volume of pre-strip required which can be effectively moved by scrapers before the commencement of a hard rock mining. It is unlikely that the purchase of a fleet of scrapers could be justified to undertake this work which would probably be completed by a contractor in 3-6 months.

Therefore, it is suggested to adopt contract mining instead of owner mining operation. The infrastructure necessary to the mining contractor, such as administration facilities and workshop may be contemplated in the contract as contractor's responsibility, which will decrease the project's CAPEX.

## 12.6 Contract Drilling and Blasting

Considering the same arguments from mining contracts and also for security and quality service reasons, it is suggested to adopt drill and blast contract instead of owner operation.

All explosives and accessories must be stored at the planned magazine site and explosive storage facility site. The amount of explosive consumed per week will be defined basing on powder factor ( $\text{kg/m}^3$  or  $\text{kg/tonne}$ ) and the amount of material mined (ore + waste). As the Haib deposit is situated in a remote area, it is suggested to have explosive storage to operate for a reasonable time.

The explosive storage facility may be contemplated in the contract as contractor's responsibility, which will decrease the project's CAPEX.

## 12.7 Pit Optimisation

### 12.7.1 Optimisation Methodology

To do a pit optimisation a mining software is necessary. For a given resource model, cost, recovery and slope data, the software calculates a series of incremental pit shells in which each shell is an optimum for a slightly higher commodity price factor.

The sequence of the pit shell increments is sorted from the economically best (the inner smallest shell viable for the lowest commodity price) to the economically worst (the outer largest pit shell viable for the highest commodity price).

In pit optimisation, the software provides indicative discounted cashflows for two mining sequences called "best case" and "worst case" scenarios, both using time discounting of cash flows. In the best case, the optimum pit shells are mined bench by bench in increments from inner to the outer shell, resulting in a higher discounted cash flow (DCF) due to lower stripping ratios and/or higher grades in the early years of mine life. The worst case scenario is based on mining the whole pit outline bench by bench as a single pit, hence resulting in a lower DCF as a result of usually high stripping requirements in the early years of the operation.

Ordinarily, after the selection of the ultimate pit, several practical mining stages are designed and sequenced when developing a final production schedule. This sequence would provide a discounted cash flow somewhere between worst and best case scenarios. For this reason, the average discounted cash flows are calculated for each pit shell (mean of the worst and best cases) in order to emulate a practical mining sequence.

The cash flows, as described above, are exclusive of any capital expenditure or Project start-up costs and should be used for pit optimisation comparison purposes only. No project Net Present Value (NPV) can be derived from these cash flows.

### **12.7.2 Overall Pit Slopes**

The overall pit wall slope angle, which is essential for the pit optimisation study, must be based on the geotechnical parameters established by further geotechnical study.

## **12.8 Mine Design**

The mining the design will be determined considering economics, engineering and geological structure aspects. In terms of geological aspect, a further investigation will be necessary to establish parameters and create a detailed block model, which will be based on geostatistics and the geological data gathered through drilling of the prospective ore zone.

## **12.9 Tailing Disposal**

### **12.9.1 Introduction**

There will be no tailings. The spent heaps will be rehabilitated and left in place. Due to environmental reasons and water resources, the tailings from the pH adjustment process and the iron removal process will be disposed onto the spent heaps via the method of filtered dry stacked tailings.

### **12.9.2 Environmental**

In terms of environmental aspects, dry stack facilities offer a number of advantages to other surface tailings storage options – some of these include:

- Reduced water requirements, principally achieved by recycling process water and near elimination of water losses through seepage and/or evaporation;
- Groundwater contamination through seepage is virtually eliminated;
- Significant safety improvement with the risk of catastrophic dam failure and tailings runoff being eliminated;
- Easier to close and rehabilitate.

## **12.10 Waste Rock Storage**

### **12.10.1 Introduction**

It is suggested to consider stockpiling the low-grade ore to process it at the end of mine life, in case the copper price increase considerable by the end of the mine life and/or a new mineral processing technology/strategy be created or developed.

### **12.10.2 Waste Rock Storage Design**

The overall rock storage design is depend on a number of factors, such as:

1. Topography of the dump site;
2. Method of construction;
3. Geo-technical parameters of mine waste;
4. Geo-technical parameters of the foundation materials;

All of these factors combine in various ways during the life of a mine waste dump to aid in the stability of the dump or to contribute to its instability.

### 13. MINING SEQUENCE

The mining sequence has been developed for the Haib deposit for plant throughputs of 8.5 Mtpa and 20 Mtpa to provide insights of what the resource can deliver through the proposed life of mine. For the development of mining sequence:

- A life of mine (LOM) of twenty years was used while considering the different grades of the ore that can be delivered for processing and the anticipated stripping ratios
- An overall slope angle of between 55° to 60° was used to define the pushback limits of mining pits
- Using the resource block model as a guide:
  - Polygons were digitised to define the ore packets
  - Average grades of those packets were calculated
- Mining plan of the ore was centred on 5 areas (Figure 13-1) named:
  - Pit 1 – southeast pit includes the adit area.
  - Pit 2 – central pit.
  - Pit 3 – northwest pit
  - Pit 4 – just south of Pit 3 and a possible westward extension of the Pit 2 higher grade mineralisation
  - Pit 5 – a small pit to the northeast of Pit 1

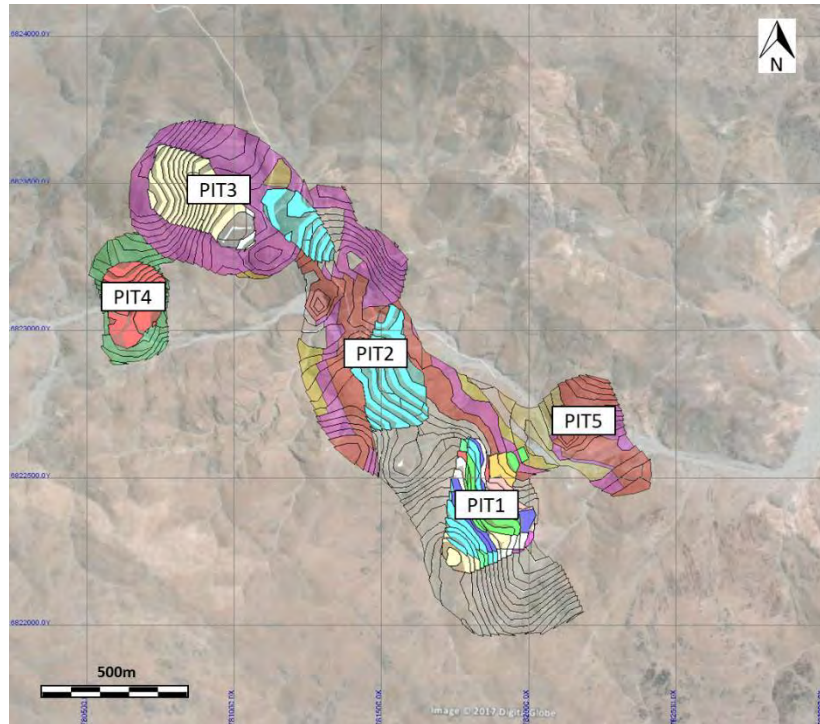

**Figure 13-1: Plan showing the polygons used to compile the mining schedule**

### **13.1 8.5 Mtpa Mining Sequence**

The 8.5 Mtpa mining sequence was developed based on relaxed cut-off grade with stretched polygons to include material that have been previously classified as waste. A dropped cut-off grade of 0.3% Cu was used which resulted in lower Cu grade of the polygon while obtaining a significant reduction of the stripping ratio as less material being classified as waste.

Under the approach of lower cut-off grade, the stripping ratio remains below 1 until Year 12 rising to a peak in Year 17 of 1.57. Beyond this the stripping ratio drops back to below 1 for the remainder of the 20 years. The mining sequence is shown in Table 13-1 and Figure 13-2. Over the 20-year period, the average LOM stripping ratio is 0.71. At 80% Cu recovery, 0.97 billion pounds of Cu are recoverable while at 85% this number is 1.03 billion pounds of Cu will be recovered. The lower cut-off grade and lower stripping ratios could make the project more sensible.

**Table 13-1: Summary incremental schedule for the lower cut-off, waste balancing – 8.5 Mtpa**

	Unit	Year1	Year2	Year3	Year4	Year5	Year6	Year7	Year8	Year9	Year10	Year11	Year12	Year13	Year14	Year15	Year16	Year17	Year18	Year19	Year20	Total	
<b>Ore Tonnage</b>	T	8,437,274	8,500,000	8,500,000	8,500,000	8,500,000	8,500,000	8,500,000	8,500,000	8,500,000	8,500,000	8,500,000	8,500,000	8,500,000	8,500,000	8,500,000	8,500,000	8,500,000	8,500,000	8,500,000	8,500,000	8,500,000	<b>169,937,274</b>
<b>Grade</b>																							
<b>Cu</b>	%	0.36	0.34	0.30	0.33	0.32	0.32	0.30	0.30	0.32	0.32	0.36	0.39	0.35	0.31	0.32	0.31	0.31	0.31	0.30	0.30		<b>0.32</b>
<b>Mo</b>	ppm	43.79	42.59	36.88	40.31	38.85	32.44	37.97	38.08	38.65	40.14	48.80	56.99	51.45	45.14	33.91	36.34	38.41	41.42	40.05	43.17		<b>41.27</b>
<b>Pyrite</b>	%	0.90	0.85	0.77	0.81	0.63	0.28	0.81	0.81	0.84	0.86	0.93	1.04	0.76	0.55	0.59	0.95	0.75	0.75	0.82	0.83		<b>0.78</b>
<b>Contained Metal</b>																							
<b>Cu</b>	lb	66,604,405	63,017,775	56,879,524	62,440,067	59,387,346	60,657,350	55,803,970	56,165,236	59,715,815	60,771,225	66,870,434	73,407,263	65,572,673	58,491,962	60,116,774	57,658,173	57,270,706	57,645,267	55,712,505	55,813,548		<b>1,210,002,016</b>
<b>Mo (T)</b>	T	369	362	314	343	330	276	323	324	328	341	415	484	437	384	288	309	326	352	340	367		<b>7,013</b>
<b>Pyrite (T)</b>	T	76,228	71,855	65,567	69,071	53,791	23,393	68,555	69,161	71,553	72,713	79,418	88,762	64,504	46,560	50,163	80,404	63,464	63,658	69,968	70,300		<b>1,319,090</b>
<b>80% Cu Recovery</b>	lb	53,283,524	50,414,220	45,503,619	49,952,053	47,509,877	48,525,880	44,643,176	44,932,189	47,772,652	48,616,980	53,496,348	58,725,810	52,458,138	46,793,570	48,093,419	46,126,538	45,816,565	46,116,213	44,570,004	44,650,838		<b>968,001,613</b>
<b>85% Cu Recovery</b>	lb	56,613,744	53,565,109	48,347,596	53,074,057	50,479,244	51,558,747	47,433,375	47,740,450	50,758,442	51,655,541	56,839,869	62,396,173	55,736,772	49,718,168	51,099,258	49,009,447	48,680,100	48,998,477	47,355,629	47,441,515		<b>1,028,501,714</b>
<b>Waste Tonnage</b>	T	694,039	1,942,306	1,942,306	0	8,176,066	8,176,066	8,176,066	4,699,249	4,699,249	0	0	9,122,611	9,122,611	9,122,611	9,122,611	8,803,348	13,367,962	9,853,147	6,338,333	7,726,310		<b>121,084,890</b>
<b>Grade</b>																							
<b>Cu</b>	%	0.18	0.00	0.20	0.00	0.19	0.19	0.19	0.25	0.25	0.00	0.00	0.19	0.19	0.19	0.19	0.22	0.21	0.21	0.22	0.22		<b>0.20</b>
<b>Mo</b>	ppm	33.53	0.00	30.30	0.00	30.10	30.10	30.10	33.16	33.16	0.00	0.00	31.90	31.90	31.90	31.90	38.44	38.89	38.93	39.02	42.27		<b>33.96</b>
<b>Pyrite</b>	%	0.18	0.00	0.48	0.00	0.68	0.68	0.68	1.21	1.21	0.00	0.00	0.46	0.46	0.46	0.46	0.59	0.66	0.66	0.67	0.78		<b>0.64</b>
<b>Contained Metal</b>																							
<b>Cu</b>	lb	2,695,924	8,551,532	8,551,532	0	33,869,628	33,869,628	33,869,628	25,727,748	25,727,748	0	0	37,241,047	37,241,047	37,241,047	37,241,047	41,732,506	60,617,642	45,596,575	30,575,508	38,050,225		<b>538,400,013</b>
<b>Mo</b>	T	23	59	59	0	246	246	246	156	156	0	0	291	291	291	291	338	1,146,124	384	247	327		<b>1,149,775</b>
<b>Pyrite</b>	T	1,262	9,364	9,364	0	55,410	55,410	55,410	57,034	57,034	0	0	42,356	42,356	42,356	42,356	52,375	87,967	65,373	42,780	60,545		<b>778,754</b>
<b>Total Tonnes Mined</b>	T	9,131,313	10,442,306	10,442,306	8,500,000	16,676,066	16,676,066	16,676,066	13,199,249	13,199,249	8,500,000	8,500,000	17,622,611	17,622,611	17,622,611	17,622,611	17,303,348	21,867,962	18,353,147	14,838,333	16,226,310		<b>291,022,164</b>
<b>Stripping Ratio</b>		0.08	0.23	0.23	0.00	0.96	0.96	0.96	0.55	0.55	0.00	0.00	1.07	1.07	1.07	1.07	1.04	1.57	1.16	0.75	0.91		<b>0.71</b>



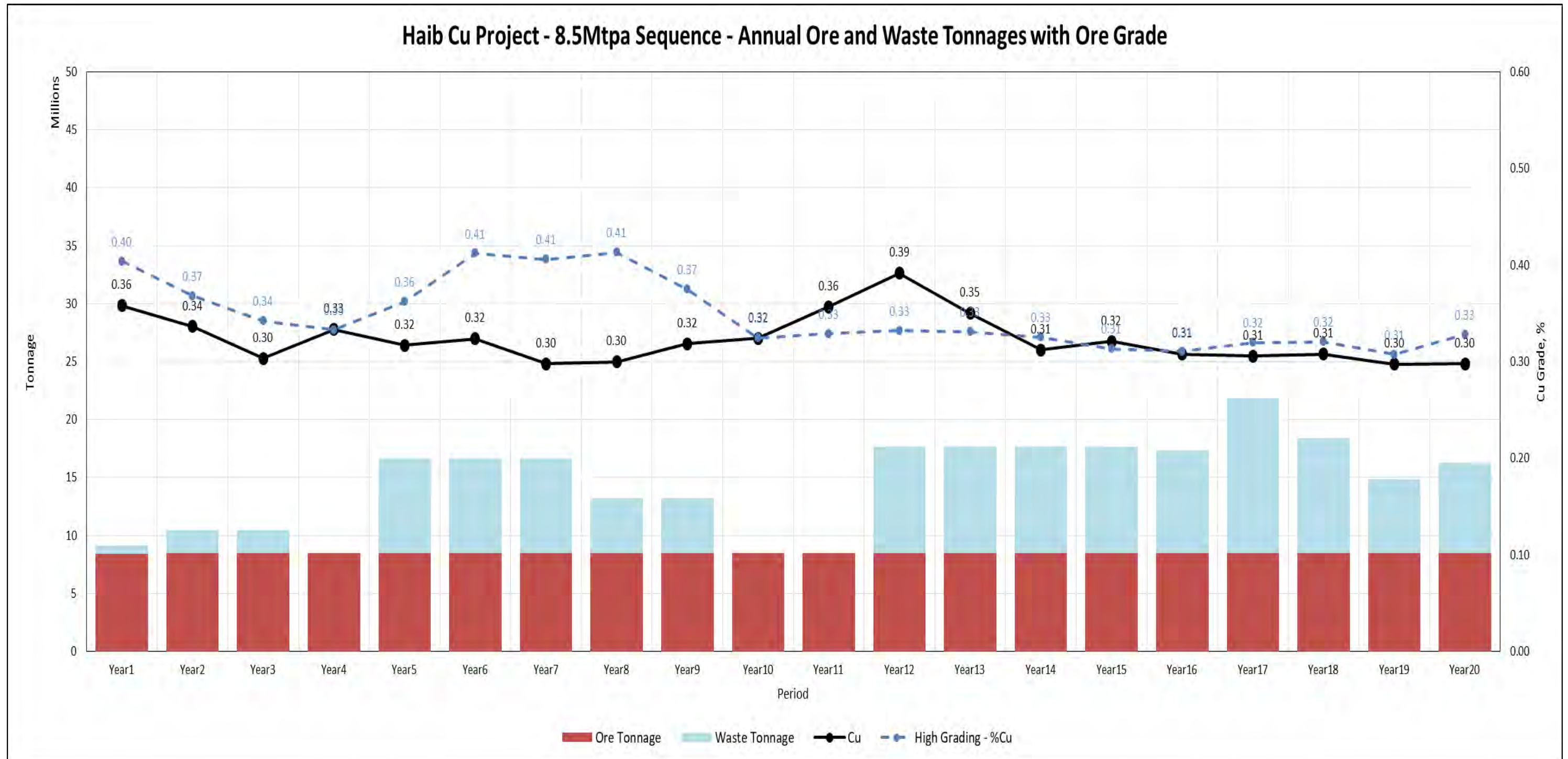

Figure 13-2: Mining sequence – 8.5 Mtpa

### 13.2 20 Mtpa Mining Sequence

The 20 Mtpa mining sequence was developed based on relaxed cut-off grade with stretched polygons to include material that have been previously classified as waste. A dropped cut-off grade of 0.3% Cu was used which resulted in lower Cu grade of the polygon while obtaining a significant reduction of the stripping ratio as less material being classified as waste.

The ore and waste polygons of the mining sequence are shown in Figure 13-3. Years 1 to 3 are very similar to the 8.5 Mtpa lower cut-off grade scenario except some of the shallow ore in Pits 4 and 5 is taken as well. During this time waste stripping is undertaken in Pit 1 and Pit 5. During Years 4, 5 and 6 ore is taken exclusively from Pit 3 while waste stripping is undertaken in Pits 1 and 2 as well as 3. In Year 7 the remaining exposed ore in Pits 3 and 4 is mined while waste stripping continues in Pits 1 and 2. From Year 8 to 17, all ore is taken from the deeper parts of Pit 1 and Pit 2. In Year 18 ore is still mined from Pit 1 while stripping starts again in Pit 3. In Year 19, exposed ore in Pit 1 is finally depleted and ore production moves to Pit 3 for the remainder of the 20-year period.

The mining sequence is shown in Table 13-2 and Figure 13-4. Over the 20-year period, the average LOM stripping ratio is 1.41. At 80% Cu recovery, 2.19 billion pounds of Cu are recoverable while at 85% this number is 2.33 billion pounds of Cu will be recovered. The lower cut-off grade and lower stripping ratios could make the project more sensible.

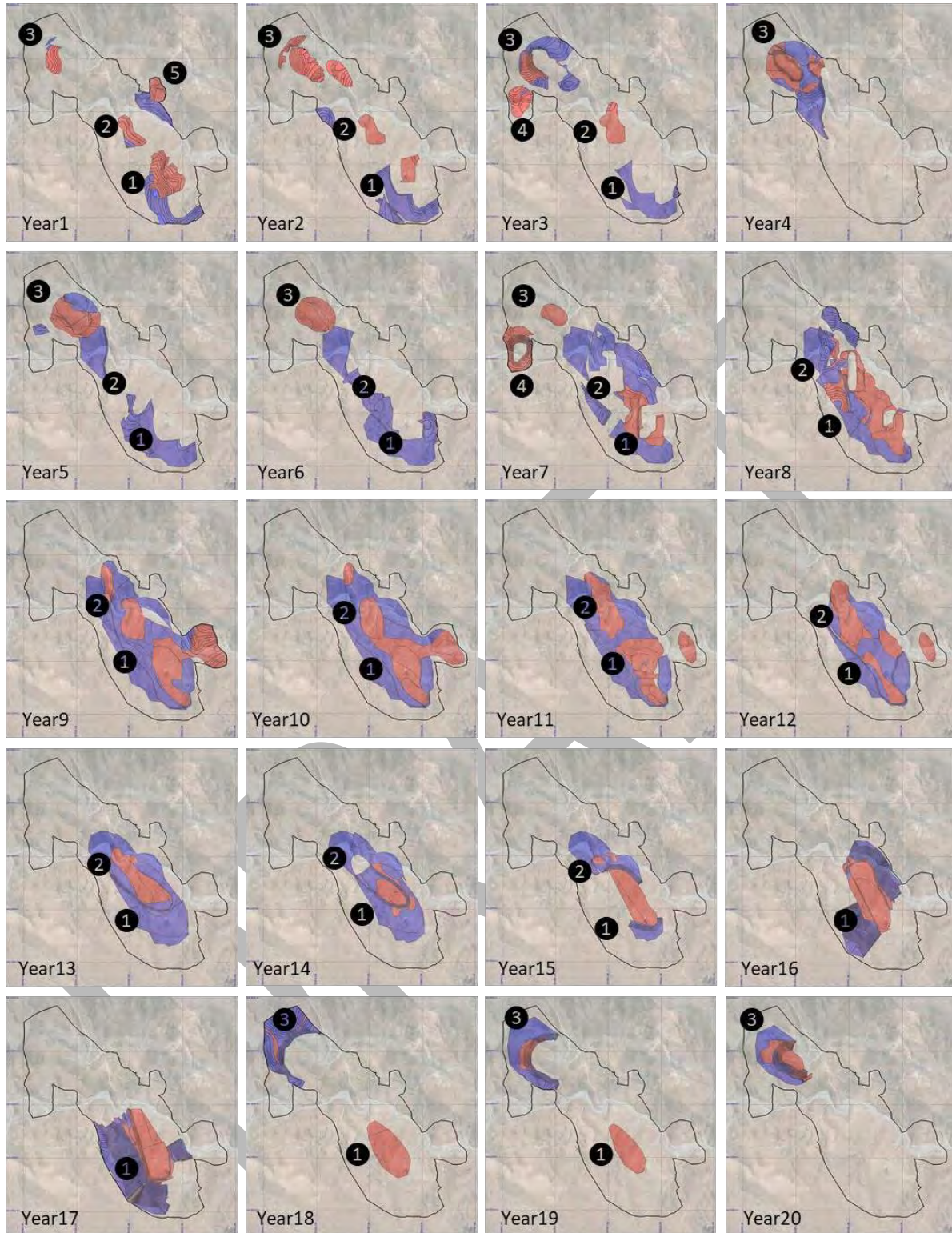

**Figure 13-3: Ore (red) and waste (blue) mining by period – 20 Mtpa**

**Table 13-2: Summary incremental schedule for the lower cut-off, waste balancing – 20 Mtpa**

	Unit	Year1	Year2	Year3	Year4	Year5	Year6	Year7	Year8	Year9	Year10	Year11	Year12	Year13	Year14	Year15	Year16	Year17	Year18	Year19	Year20	Total
<b>Ore Tonnage</b>	T	20,027,002	20,067,071	20,000,177	20,002,593	20,029,691	20,036,384	19,993,087	20,126,543	20,328,544	20,947,037	20,409,485	20,311,583	20,250,309	20,259,953	20,293,441	20,033,713	20,018,519	20,258,081	20,023,378	20,096,557	403,513,147
<b>Grade</b>		0.30	0.32	0.30	0.31	0.30	0.40	0.30	0.30	0.30	0.30	0.30	0.30	0.30	0.30	0.31	0.30	0.30	0.31	0.32	0.31	<b>0.31</b>
<b>Cu</b>	%	39.15	38.31	34.96	37.57	40.34	56.82	37.48	39.37	39.61	39.61	47.39	53.70	56.36	52.29	59.16	60.54	64.11	82.33	77.49	60.33	<b>50.84</b>
<b>Mo</b>	ppm	0.47	0.60	0.33	0.53	0.55	0.59	0.45	0.55	0.49	0.45	0.47	0.46	0.85	0.38	0.49	0.53	0.52	0.33	0.49	0.63	<b>0.51</b>
<b>Pyrite</b>	%	0.30	0.40	0.23	0.39	0.42	0.65	0.34	0.41	0.38	0.41	0.45	0.42	0.44	0.48	0.48	0.67	0.65	0.66	0.65	0.44	
<b>Chalcopyrite</b>	%	0.30	0.32	0.30	0.31	0.30	0.40	0.30	0.30	0.30	0.30	0.30	0.30	0.30	0.30	0.31	0.30	0.30	0.31	0.32	0.31	<b>0.31</b>
<b>Contained Metal</b>																						
<b>Cu</b>	lb	132,330,203	139,377,758	130,126,377	136,051,057	133,328,748	175,568,017	132,495,821	133,036,873	134,514,647	137,653,645	137,200,959	135,804,945	134,183,305	134,554,333	136,663,217	133,197,345	131,399,811	136,373,918	139,567,666	135,688,468	<b>2,739,117,113</b>
<b>Mo (T)</b>	T	784	769	699	752	808	1,139	749	792	805	830	967	1,091	1,141	1,059	1,201	1,213	1,283	1,668	1,552	1,212	<b>20,514</b>
<b>Pyrite (T)</b>	T	94,123	120,236	65,425	106,379	109,860	117,963	89,865	109,888	98,660	93,760	95,797	93,912	172,725	77,479	98,478	105,785	103,191	66,619	98,061	127,471	<b>2,045,679</b>
<b>80% Cu Recovery</b>	lb	105,864,162	111,502,206	104,101,101	108,840,845	106,662,999	140,454,413	105,996,657	106,429,498	107,611,718	110,122,916	109,760,767	108,643,956	107,346,644	107,643,466	109,330,574	106,557,876	105,119,849	109,099,135	111,654,133	108,550,775	<b>2,191,293,690</b>
<b>85% Cu Recovery</b>	lb	112,480,672	118,471,094	110,607,420	115,643,398	113,329,436	149,232,814	112,621,448	113,081,342	114,337,450	117,005,598	116,620,815	115,434,203	114,055,809	114,371,183	116,163,734	113,217,743	111,689,839	115,917,831	118,632,516	115,335,198	<b>2,328,249,546</b>
<b>Waste Tonnage</b>	T	9,327,981	12,863,675	12,148,644	23,517,417	24,481,866	25,600,600	24,019,996	29,507,486	30,782,332	30,064,356	30,361,672	30,644,724	38,558,269	37,199,246	30,662,596	27,488,113	51,983,203	39,319,262	32,535,158	28,667,111	<b>569,733,708</b>
<b>Grade</b>																						
<b>Cu</b>	%	0.16	0.16	0.16	0.18	0.18	0.18	0.20	0.19	0.20	0.21	0.21	0.21	0.22	0.22	0.20	0.17	0.18	0.13	0.17	0.19	<b>0.19</b>
<b>Mo</b>	ppm	29.56	31.68	28.26	31.65	31.96	32.68	34.03	44.97	41.31	36.86	43.82	40.50	46.31	47.70	54.66	33.88	47.82	30.29	32.95	46.52	<b>39.91</b>
<b>Pyrite</b>	%	0.27	0.23	0.47	0.56	0.38	0.36	0.43	0.48	0.47	0.47	0.47	0.45	0.47	0.40	0.42	0.29	0.38	0.48	0.52	0.40	<b>0.43</b>
<b>Chalcopyrite</b>	%	0.17	0.17	0.20	0.27	0.28	0.31	0.32	0.34	0.35	0.35	0.37	0.39	0.37	0.36	0.38	0.39	0.35	0.22	0.34	0.33	
<b>Contained Metal</b>																						
<b>Cu</b>	lb	15,053	20,585	18,988	95,307,520	95,585,076	103,692,386	104,444,130	125,553,672	138,245,899	137,102,763	139,105,532	144,609,348	187,148,761	560,198,422	135,869,167	103,902,308	206,365,722	114,061,225	122,686,341	118,234,430	<b>2,632,167,326</b>
<b>Mo</b>	T	276	408	343	744	782	837	817	1,327	1,272	1,108	1,331	1,241	1,786	6,284	1,676	931	2,486	1,191	1,072	1,334	<b>27,245</b>
<b>Pyrite</b>	T	25,351	29,122	57,319	132,199	94,178	92,205	104,276	142,272	144,410	140,068	142,323	137,648	183,004	595,551	128,333	79,791	197,621	189,806	167,903	113,291	<b>2,896,670</b>
<b>Total Tonnes Mined</b>	T	29,354,983	32,930,747	32,148,821	43,520,010	44,511,557	45,636,983	44,013,083	49,634,030	51,110,876	51,011,393	50,771,158	50,956,306	58,808,578	230,056,927	50,956,037	47,521,826	72,001,721	59,577,343	52,558,536	48,763,668	<b>1,145,844,583</b>
<b>Stripping Ratio</b>		0.47	0.64	0.61	1.18	1.22	1.28	1.20	1.47	1.51	1.44	1.49	1.51	1.90	1.84	1.51	1.37	2.60	1.94	1.62	1.43	<b>1.41</b>

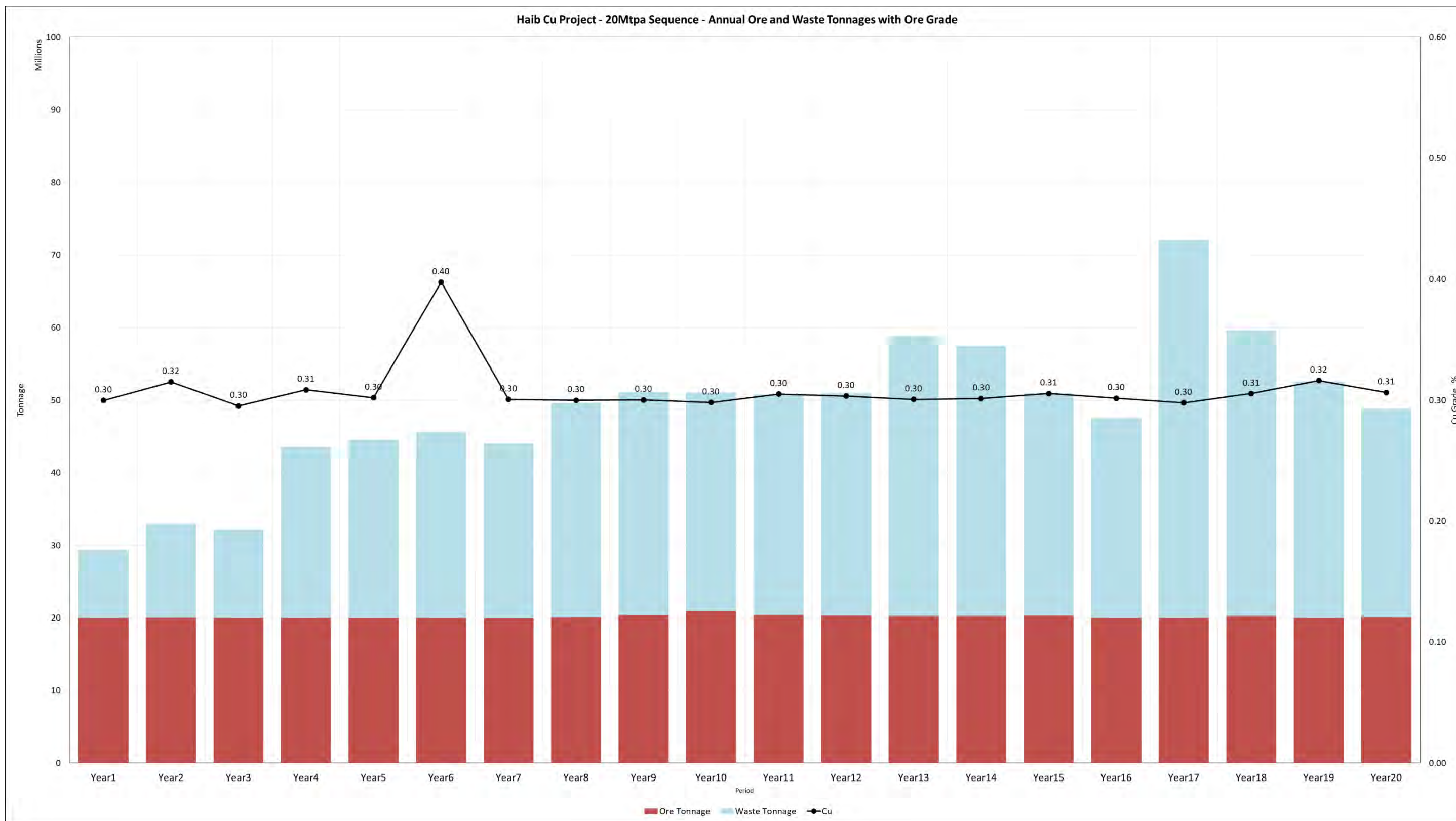
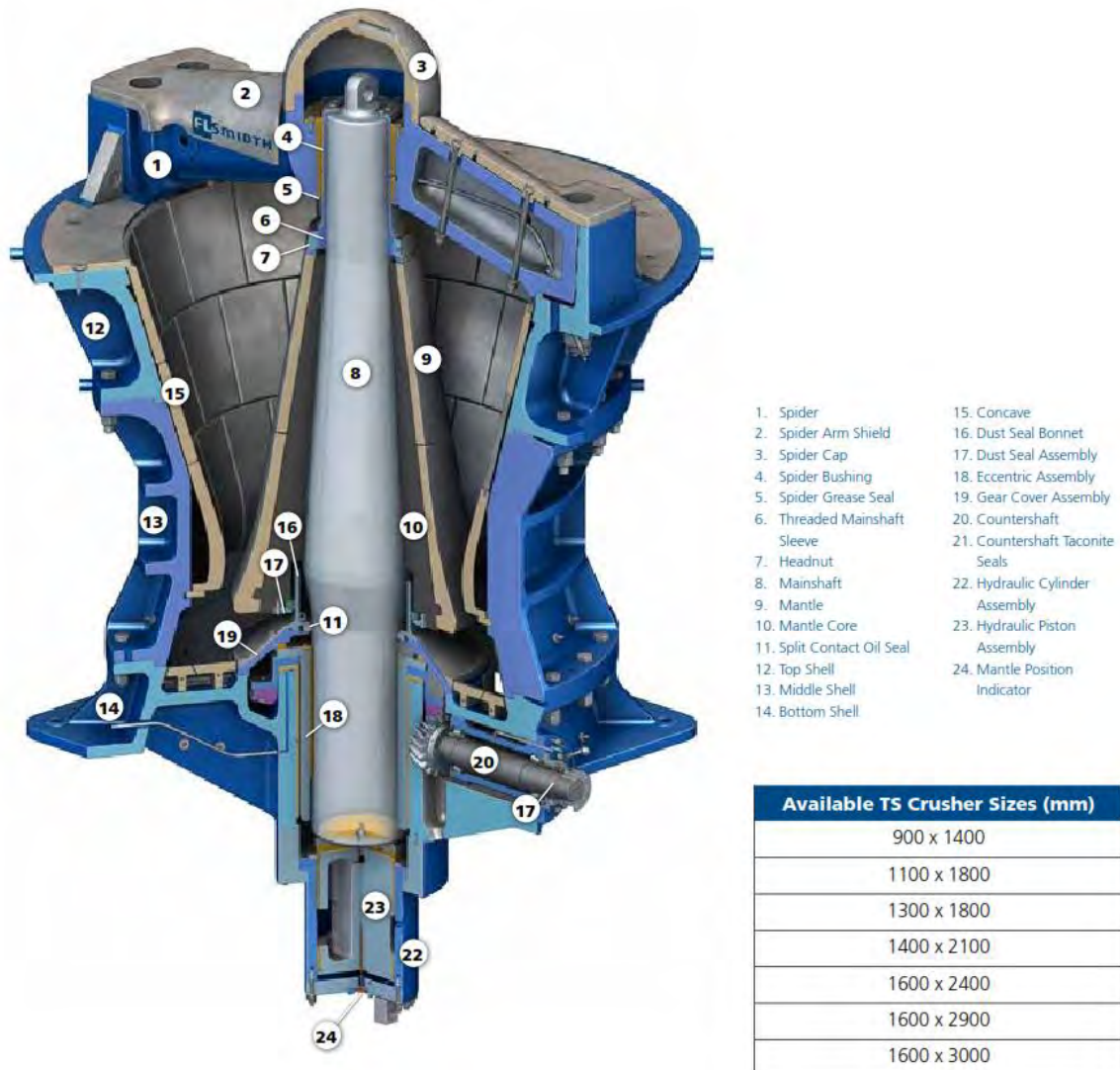

Figure 13-4: Mining sequence – 20 Mtpa

## 14. HEAP LEACHING BACKGROUND INFORMATION

### 14.1 Primary Crushing



**Figure 14-1: Primary crusher schematic**

The primary crusher is a gyratory crusher as seen above in Figure 14-1. Primary crushing is the first stage of crushing and the initial size reduction of ore from run of mine ore (ROM) stockpile. The ore is crushed to a suitable size for conveyor transport to a coarse ore stockpile. The mine trucks tip ore directly into the primary crusher. The crusher is in an excavated area usually on three levels, and has lubricating oil and dust collection systems incorporated. The feed size is less than 750 mm and they produce a product size passing 200mm for further processing.

## 14.2 Secondary Crushing

The purpose of the secondary crusher is to crush ore from the primary crusher to a size passing 50mm which can be fed to the High Pressure Grinding Rolls (HPGR) circuit.

The secondary cone crusher is similar to a gyratory crusher in that it has a mantle and bowl with replaceable manganese alloy wear liners. It reduces the ore size from 200 mm to a size suitable to feed the HPGR. These are heavy large pieces of equipment mounted on substantial concrete foundations (Figure 14-2).

The cone crusher mantle sits in an eccentric so as the drive pulley rotates the mantle opens and closes around the periphery. The ore feed is passing 200 mm and produces a product passing 50 mm. Product produced is proportional to power drawn. The secondary crusher has nitrogen tramp relief and the gap is adjusted as the liners wear.

- Features**
- Integral counter shaft box ensures a stronger design and decreased dust ingress
  - Socketless design facilitates eccentric assembly removal
  - Fail-safe hydraulic system allows crusher to be operable after a failed piston
  - Main frame inspection doors allow operator to view wear liners without disassembly or crawling underneath the machine



- |                        |                            |
|------------------------|----------------------------|
| 1. Hopper Assembly     | 15. Main Frame Seat Liner  |
| 2. Bowl                | 16. Tramp Release Cylinder |
| 3. Adjustment Cap      | 17. Main Shaft             |
| 4. Drive Ring          | 18. Eccentric              |
| 5. Feed Plate Assembly | 19. Counterweight          |
| 6. Head Assembly       | 20. Gear                   |
| 7. Torch Ring          | 21. Countershaft           |
| 8. Mantle              | 22. Pinion                 |
| 9. Bowl Liner          | 23. Wedge                  |
| 10. Socket Liner       | 24. Arm Guard              |
| 11. Adjustment Ring    |                            |
| 12. Clamping Cylinder  |                            |
| 13. Main Frame         |                            |
| 14. Main Frame Liner   |                            |

Raptor® cone crushers come in the following models: 200, 300, 400, 500, 600, 900, 1000, 1100, 1300 and 2000

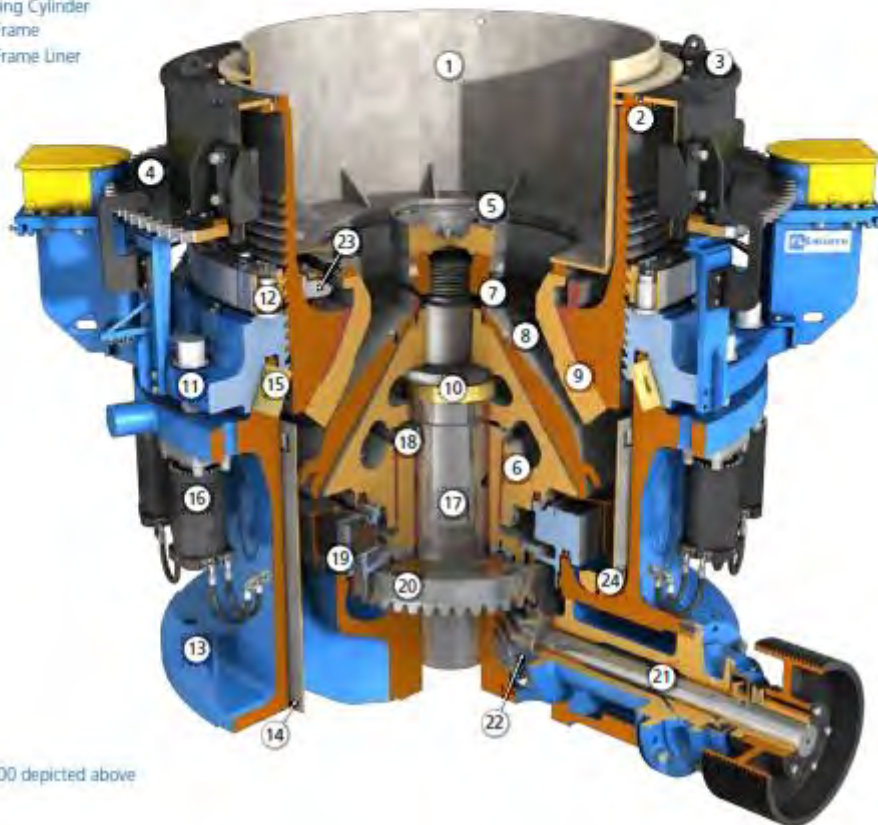

Raptor® 1300 depicted above

**Figure 14-2: Secondary crusher schematic**

### 14.3 Coarse Screening

The purpose of the coarse screens is to classify product that meets a certain size and return the oversize back to crushing. Capacity and efficiency are conflicting requirements of vibrating screens. The vibrating screen uses screen media (woven mesh in this case) to effect the separation of undersize and oversize.



The screens consist of side plates and a screen frame the screen mesh sits on. They have an exciter which causes the screen to vibrate and separate ore smaller than the screen size and allow the oversize to pass over the top of the screen (Figure 14-3).

Capacity is defined as: Quantity of material fed to the screen per unit time

Efficiency is defined as: The measure of the effectiveness of the screen to separate different sized material.

$$\text{Screen Efficiency} = U / F * 100\%$$

Where:

U = mass fraction in undersize product i.e. less than the screen size

F = mass fraction of true undersize in feed

The screen cloths wear and are replaceable items on a regular basis.



**Figure 14-3: Typical secondary screen**

Typically, screens have a life of 8 to 12 years. After this period of time due to cyclic vibration the metal fatigues and cracks appear. At this point in time the main frame and side plates must be replaced. The exciter mechanism can continue to be used.

## 14.4 Tertiary Crushing (HPGR)

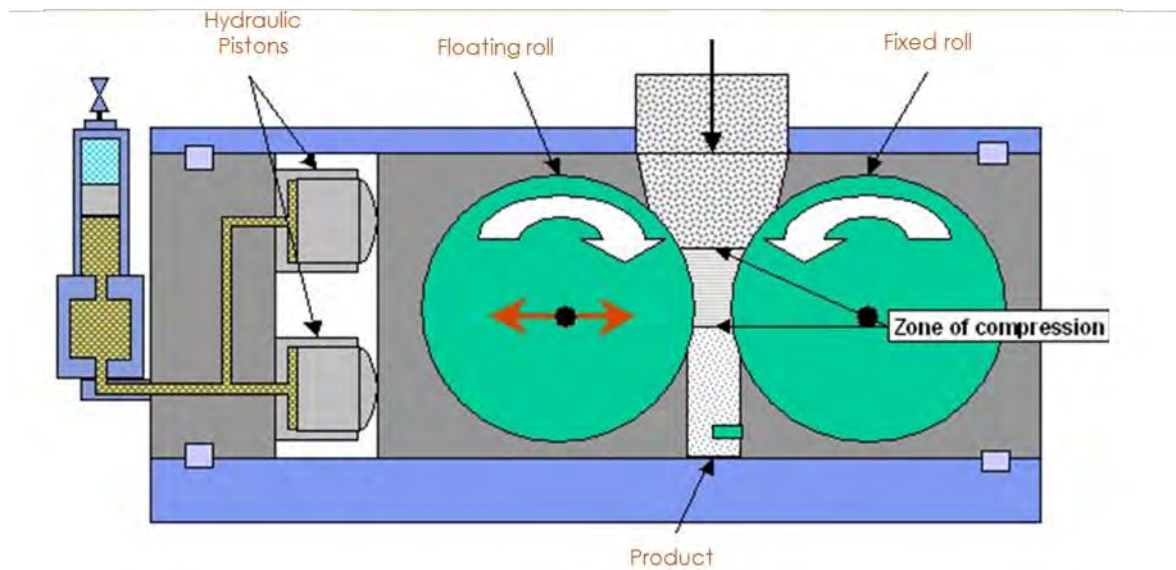

**Figure 14-4: Typical HPGR schematic**

The tertiary crushing is achieved using HPGR's which are similar to roll crushers but have high pressure hydraulic cylinders keeping the rolls together (Figure 14-4). The rolls have studs and the tyres are replaced after a period when they become worn. The feed size is 50 mm and the product size is less than 3 mm. The HPGR is very suitable for very hard high wear rock such as Haib ore.

The purpose of the HPGR is to crush hard ore to a very fine size not possible using conventional crushers. The roll facings wear and must be replaced every say 8,000 hours depending on the abrasiveness of the ore.

## 14.5 Agglomeration



**Figure 14-5: Agglomeration drum**

Agglomeration is a process where wet ore is added with binder, water and acid in order for the drum to roll the ore and stabilise the clay content in the ore (Figure 14-5, Figure 14-6). It is necessary to agglomerate fine ore particles to achieve satisfactory percolation rates when irrigating the heap.

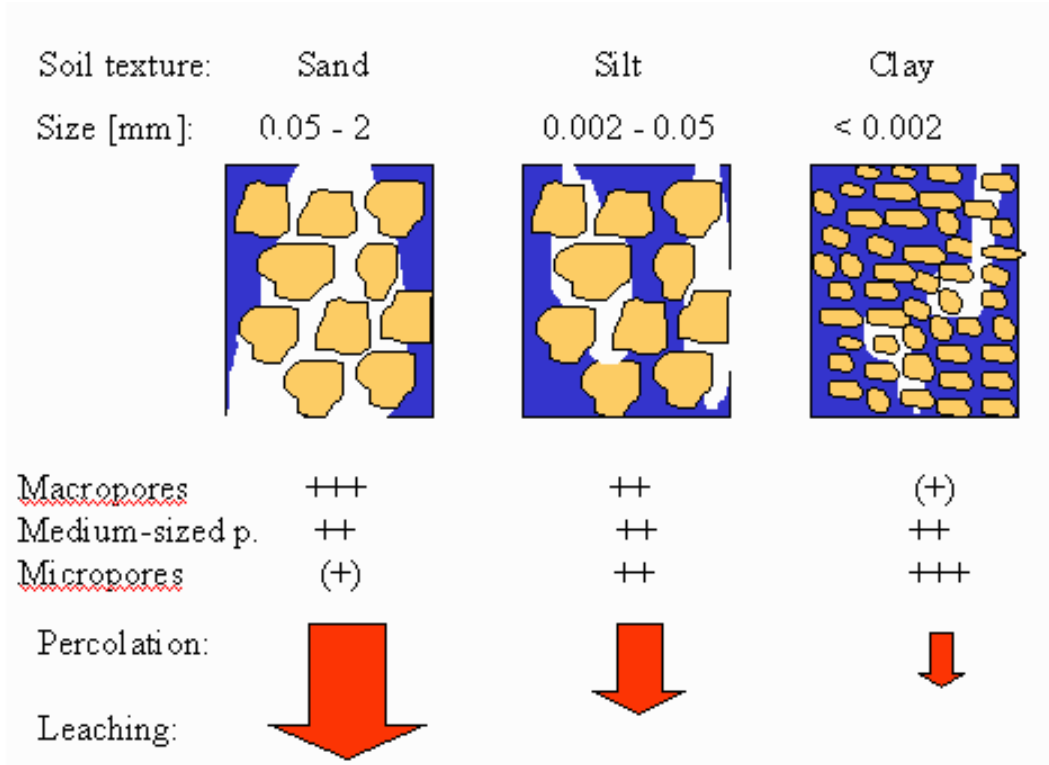

**Figure 14-6: Agglomeration drum**

## **14.6 Percolation**

Agglomeration improves percolation by binding up the fines component of the ore to be stacked (Figure 14-7). Cement, commonly used as a binder in gold heap leach operations is unsuitable due to the acidic environment and a polymeric binder such as anionic polyacrylamides should be used. Typical polyacrylamide binder consumption rates 100 to 200 g/t are common for acidic heap leach operations. Agglomeration is necessary to maintain percolation rates and avoid the formation of ‘dead zones’ within the heap where the migration of clays results in uneven leachate flow distribution.

Maintaining high percolation rates and preventing the migration of clays is key to high metal recovery rates. Metal recovery rates can be improved by using leach liquor in the binding process. Reactions commence in the agglomeration drum a long time before the ore would normally be irrigated.



**Figure 14-7: Un-agglomerated ore with clay**

## 14.7 Stacking



**Figure 14-8: Grasshopper conveyors and stacker**

Figure 14-8 shows ore being conveyed by grasshopper conveyors onto a stacker which places ore on the heap.

The stackers slew in an arc spreading the ore on the heap and can move back as the heap builds up (Figure 14-9). Grasshopper conveyors are used to adjust the stacker as it retreats from the heap.



**Figure 14-9: Grasshopper conveyors and stacker**

## 14.8 Bacterial Leaching

The high content of chalcopyrite in primary copper sulfide ores has made it difficult to be leached in acid sulfate media, as mineral surface passivation will result in a lower leaching rate when leaching is conducted at ambient pressures and temperatures. In this case, bioleaching at 50-85°C has been shown to overcome the effects of surface passivation of chalcopyrite, which will lead to a faster leaching rate and higher copper recovery.

Bioleaching of sulfide minerals relies on the use of microbial cultures that catalyse the oxidation reaction of sulfide minerals with oxygen through the generation of iron (III) from the oxidation of iron (II) and direct oxidation of sulfur, where additional heat will be generated and the leaching rate of minerals can be further enhanced. Heap bioleaching at elevated temperatures is mainly autothermal, relying on heat generated from the microbial oxidation of the sulfide minerals. Although the operating principle of heap bioleaching is relatively simple, the process design of this operation requires a thorough understanding of heap hydrology, chemical and physical properties of the ore, leaching kinetics of sulfide minerals, culture conditions of selected microorganisms, and fluid dynamics and process heat transfer of the process to properly manage the heat loss and operating temperature of the process.

The predominant metal sulfide dissolving microorganisms are acidophiles (microorganisms that thrive under highly acidic conditions, usually at pH 2.0 or below), and they have the capability to oxidise sulfur compounds and iron (II) ions. The most common acidophilic iron/sulfur oxidising bacteria are the mesophilic *Acidithiobacillus thiooxidans* (*A. thiooxidans*) and *Acidithiobacillus ferrooxidans* (*A. ferrooxidans*). In most circumstances, the endogenous bacteria (bacteria that naturally resides within a closed system) within the ore are not

excluded and those being acclimatised to high level may contribute as an effective bioleaching catalyst. Acclimatisation of bacteria generally refers to the process where continuous exposure of microbial population to a chemical results in a more rapid biodegradation of the chemical than initially observed. Due to the unique characteristics of each ore, the microbial consortium (two or more microbial groups living symbiotically) varies according to the specific type of mineral and its environmental conditions. This is the reason why the microbiological industry continues to invest in a variety of research to find new strains to obtain optimised bacterial bioleaching results.

Bioleaching of chalcopyrite can be represented by the equations below, where the leaching of  $\text{CuFeS}_2$  follows two stages of dissolution and then further oxidation, with  $\text{Cu}^{2+}$  ions being left in the solution.

Initial Oxidation by Iron (III):

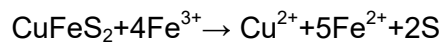

Iron oxidation:

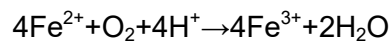

Sulfur oxidation:

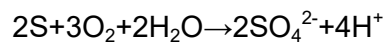

Net reaction:

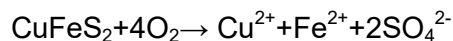

## 14.9 Aeration

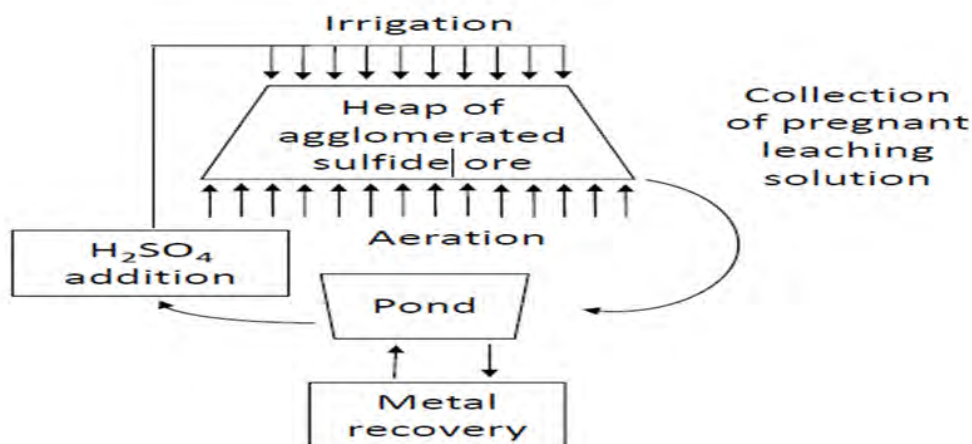

Figure 14-10: Requirement for aeration of heap leaching

For bacterial leaching of sulfides we must have:

- Elevated temperatures → increased kinetics.

- Aeration necessary for sulfides
- Sulfide source for bacteria

#### 14.10 Heap Leaching

##### Advantages:

- Relatively low CAPEX and OPEX comparative to milling and tank leaching.
- Quick installation and setup.
- Simple process; requiring low levels of training for routine operations.

##### Disadvantages:

- Reduced metal recovery comparative to milling and tank leaching.
- Cash flow delays at start-up.
- High inventory of valuable metals.
- Leach kinetics – slow to change and difficult to analyse potential problems that may develop.
- High risk – especially for lower-grade ores with little ‘margin for error’.
- Management of exhausted heaps and closure.

Heap leaching often offers a viable alternative to milling/leaching. The use of heap leaching as a secondary operation to existing mill sites processing lower-grade ores is sometimes disregarded or overlooked.

Heap leaching is a mineral processing technology whereby large piles of crushed or run-of-mine rock (or occasionally mill tailings) are leached with various chemical solutions that extract valuable minerals. The largest installations in terms of both land area and annual tonnage are associated with gold leaching with cyanide and copper mines, where copper-containing minerals are irrigated with a weak sulfuric acid solution.

This solution dissolves the copper from the mineral and the “pregnant leach solution” (PLS) passes down through the ore pile and is recovered at the bottom on the “leach pad,” which usually consists of a geomembrane liner, sometimes clay (either to create a true composite liner or more commonly as a good quality bedding layer for the geomembrane), and a permeable crushed rock drainage system called an “overliner”, with a drainage pipe network. In some applications (principally oxide copper ores) thin liners are installed between layers or “lifts” of ore to intercept the PLS earlier. Copper is extracted from the PLS using solvent



extraction and the acidic solution is recycled back onto the leach pile (Figure 14-11). Gold heap leaching is similar, except that the solvent is cyanide.

Leach pads can be divided into four categories: conventional or “flat” pads, dump leach pads, valley fills and on/off pads. Conventional leach pads are relatively flat, either graded smooth or terrain contouring on gentle alluvial fans such as in the Chilean Atacama desert, Nevada and Arizona, and the ore is stacked in relatively thin lifts (5 to 15 m typically). Dump leach systems are similar or can include rolling terrain; the term “dump” usually means that the lifts are much thicker (up to 50 m). Valley fill systems are just that – leach “pads” designed in natural valleys using either a buttress dam at the bottom of the valley, or a levelling fill within the valley.

The success of a heap leach operation, or otherwise, is dependent upon a number of factors, notably:

- The type of ore to be treated
- The extent of testwork completed to define the process
- The interpretation of the testwork results
- Ore preparation prior to stacking
- Agglomeration and curing requirements

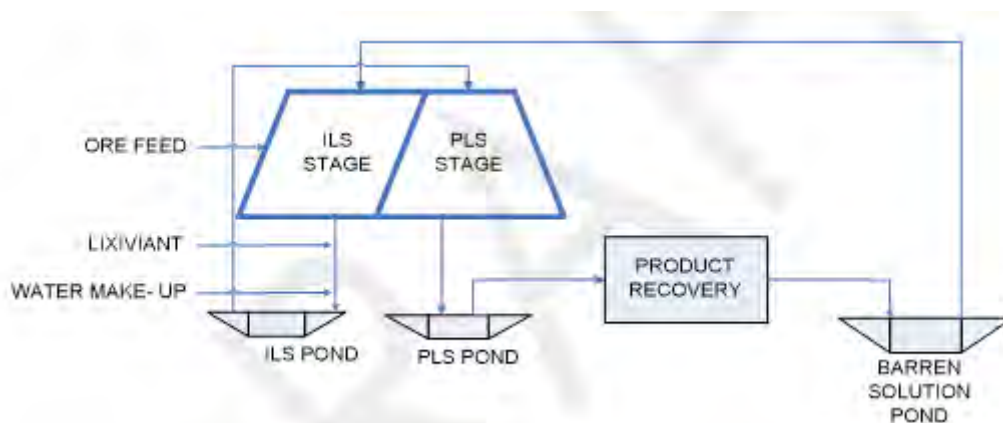
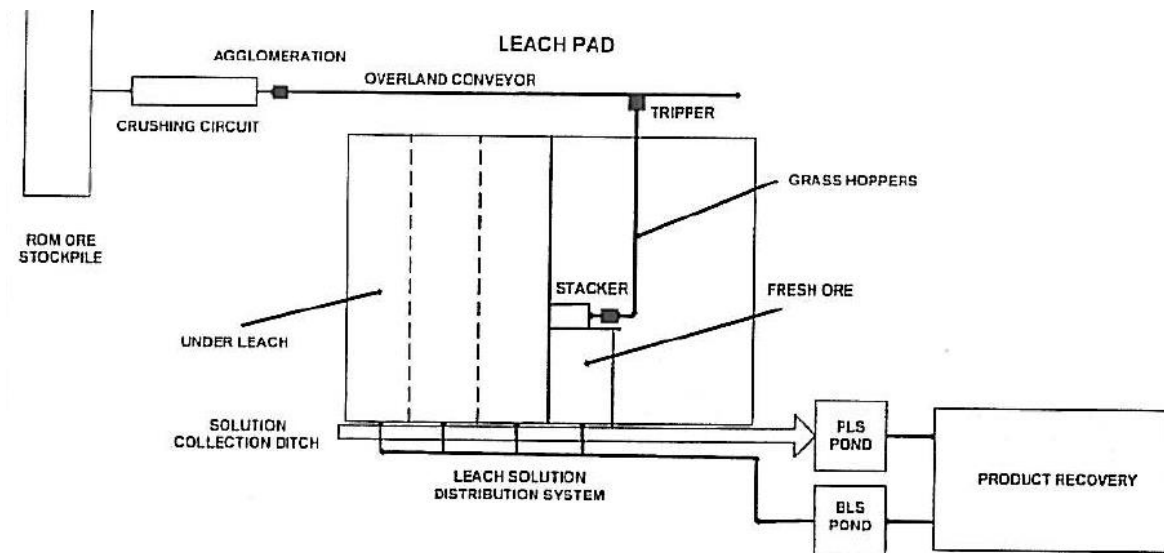

**Figure 14-11: Heap leach flowsheet**

Typical heap leach arrangements are also shown in Figure 14-12 and Figure 14-13.



**Figure 14-12: Ore on pad with solution flowing to toe drain**



**Figure 14-13: Typical leach pad general arrangement**

### 14.11 Heap Leach Testwork

Heap leaching is a low OPEX and CAPEX route but a high risk option. Only 50% of heap leaches can be classified as successful.

#### Design considerations:

- Size of ore reserve
- Grade of ore
- Crush size sensitivity
- Percolation

- Leach kinetics
- Geological location of ore
- Local weather conditions
- Economics

**Factors affecting testwork:**

- Ore mineralogy
- Ore grade
- Acid consumption
- Size of deposit
- Commitment of company

**Ore characteristics:**

- UCS, CWI, SG, bulk density, moisture, Ai.
- Bottle roll tests
- Crush size sensitivity
- Initial column testing
- Water analysis
- Agglomeration
- Percolation
- Leach kinetics
- Soak test - slumping
- Large scale columns

## **14.12 Pond Interconnections**

Figure 14-14 indicates the pipe interconnection between the heaps and ponds. The environmental pond is for rain events. The ability to water wash and recycle each heap is important.

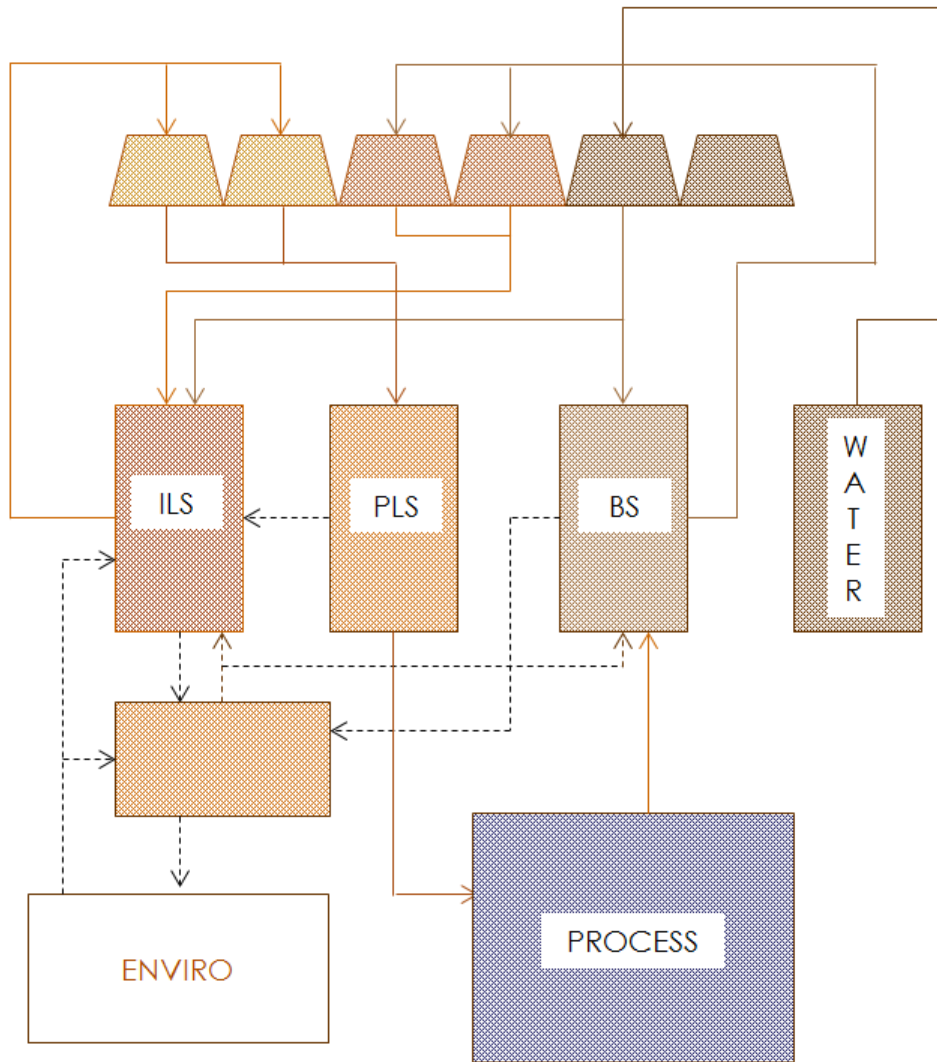

**Figure 14-14: Pond Interconnection**

- ILS= intermediate liquor solution
- PLS=pregnant liquor solution
- BS= barren liquor solution
- PROCESS= solvent extraction and electrowinning (SX/EW)

### 14.13 Solvent Extraction

Solvent extraction (SX), also called liquid-liquid extraction (LLE) and partitioning, is a method to separate metal compounds based on their relative solubilities in two different immiscible liquids. Immiscible liquids do not mix and separate into layers when shaken together and allowed to settle. Aqueous copper solution is mixed with kerosene containing an copper selective organic (e.g. LIX) and after mixing, the copper is extracted into the organic phase (extraction). A schematic of the process steps is shown in Figure 14-15.

The organic is then stripped in acid to reverse the process to produce a rich pure copper liquor which can be electrowon to produce metallic copper.

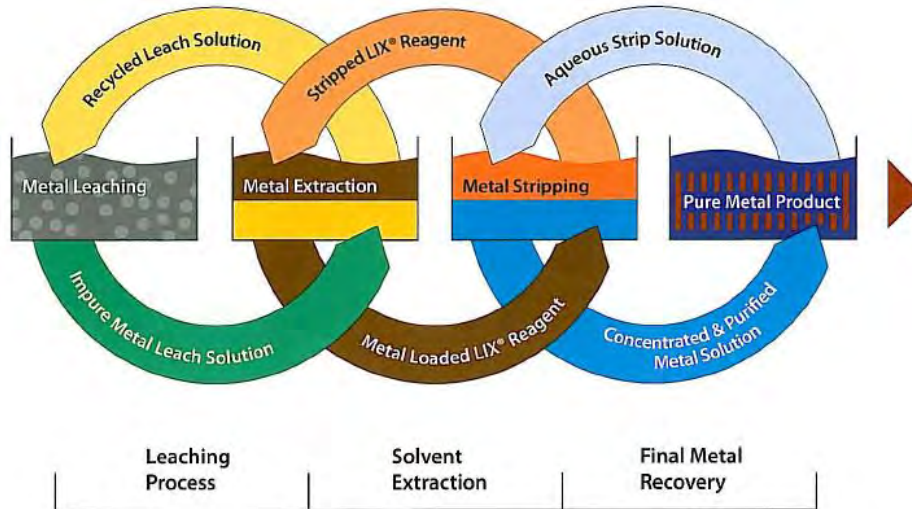

**Figure 14-15: Solvent extraction process**

#### 14.14 Electrowinning



**Figure 14-16: Electrowinning process**

Electrowinning is an electrolytic technology using two electrodes – an anode and cathode (Figure 14-16). It is basically electroplating on a large scale.

Anodes are rolled lead-alloy sheets, which are virtually inert but still subject to corrosion over long periods of time. Cathode is a copper starter sheet made of copper plating onto titanium or stainless steel.

Electrowinning involves applying an electrical potential to the electrodes in the copper electrolyte then plating pure metallic copper onto the cathodes. The pregnant solution (electrolyte) normally contains 25-60 g/L copper sulfate ( $\text{CuSO}_4$ ) and 50-180 g/L sulfuric acid ( $\text{H}_2\text{SO}_4$ ). The temperature of the electrowinning process is maintained at 50-60°C and the

current density is maintained at about 300 A/m<sup>2</sup>. The power consumption rate of a electrowinning cell is typically at 2 kWh/kg of metal cathode produced.

#### **14.15 PLC and SCADA Control**

Supervisory control and data acquisition (SCADA) is a control system architecture comprising computers, networked data communications and graphical user interfaces for high-level process supervisory management. Plant drives and automatic valves are operated from the control room via the SCADA system. The SCADA system operates the control loops utilised to control specific operating units/processes of the plant. The plant is controlled by Programmable Logic Controllers (PLC's) that are housed in the various motor control centres (MCC's). Each drive, with the exception of spillage pumps, has a run command output from the PLC. The Control Room Operation (CRO), situated in the Central Control Room (CCR), uses the SCADA system to observe and operate the plant.

The distinct plant areas are presented in graphic form on individual screens which displays the status of selected drives and instrumentation in that area. Alarms are generated and displayed in a dedicated portion of the screen for the operator to action.

Drives can be individually started from the SCADA system and all interlocking between drives are carried out in the PLC. The drive interlocks can be disabled from SCADA system and run in "maintenance mode" or manual from the field stop/start station. Once the drive is placed back in automatic mode, the interlocks are re-enabled for sequence start-ups and shut-downs. The operators have to walk through the plant before start-up to make sure that it is safe to start any drive.

## 15. RECOVERY METHODS

In this updated PEA report, only whole ore heap leaching was considered for the recovery of copper from the Haib deposit. The primary reason for the selection of heap leaching is the low grade nature of the deposit and the vast scale of the orebody.

Previous work conducted on the Haib project suggests that a conventional crush-grind-float and sale of copper concentrate is not economically feasible due to the low grade and hardness of the ore; requiring a significant amount of energy for grinding. The low costs associated with heap leaching compared to a whole ore flotation circuit is believed to improve the viability of the project.

Heap leaching is traditionally performed on oxide material, although there has been increasing development in the application to acid insoluble sulfides. Previous sighter amenability testwork suggests the Haib material can extract high amounts of copper, up to 95.2% via a bacterial assisted leaching. The current testwork programme has also confirmed that bacterial assisted heap leaching can achieve copper recoveries over 90%. Given these results there is no reason to suggest the chalcopyrite in the Haib deposit will not be amenable to bacterial assisted heap leaching.

The flowsheet development was based on the measured and indicated resource of 456.9 Mt at 0.31% copper. The throughputs of the project are based on 8.5 Mtpa and 20 Mtpa, which corresponded to a project life of 55 years and 24 years respectively. Each throughput scenario has considered two copper recoveries; 80% copper recovery and 85% copper recovery. The flowsheet and subsequent mass balance, equipment sizing and capital estimate calculations were performed based on the following cases:

- Option 1: 8.5 Mtpa with 80% copper recovery with  $\text{CuSO}_4$  (base case)
- Option 2: 8.5 Mtpa with 85% copper recovery
- Option 3: 8.5 Mtpa with 85% copper recovery with  $\text{CuSO}_4$
- Option 4: 20 Mtpa with 80% copper recovery with  $\text{CuSO}_4$
- Option 5: 20 Mtpa with 85% copper recovery
- Option 6: 20 Mtpa with 85% copper recovery with  $\text{CuSO}_4$

The recovery of the six options is based on limited testwork. There is the possibility to increase the copper recovery and hence improve the project economics. This could be done by further laboratory testwork or during the pilot plant operation at later stage. There are a number of areas where the recovery could be improved, specifically optimising the bacterial column leach conditions.

Due to the unrealistically long project life, it was suggested to start at 8.5 Mtpa and operate at this throughput for approximately 3 years and then execute staged expansions to eventually ramp up to 20 Mtpa, ultimately shortening the project life. As the resource expands and the inferred data progresses towards measured, then additional expansion to possibly 40+ Mtpa should be assessed.

## **15.1 Ore Transport**

The Haib copper deposit is situated in highly undulating terrain. Heap leaching using a valley heap method would be suitable considering the topography, although the cost associated with earthworks to provide a flat surface for the process plant and the cost associated with transportation of raw material in, and products out, warrant the placement of the process plant on flatter grounds. A long distance conveyor (4.5-5 km) has been proposed, which would transport crushed ore from the mine site to the process plant for subsequent grinding.

## **15.2 Process Description**

### **15.2.1 Crushing and Ore Handling - 8.5 Mtpa**

Run of Mine (ROM) ore is transported by truck from the mine to the ROM stockpile area near the crushing plant. The material is transferred to a ROM bin, which feeds to a primary crusher. The primary crusher is a gyratory crusher suited to higher crushing capacities. The closed side setting (CSS) of the gyratory crusher is expected to be set at 160 mm with an assumed  $P_{80}$  of 137 mm to be produced. The output of the gyratory crusher is discharged into a surge vault where it will be directed to a primary crusher discharge conveyor via an apron feeder. The gyratory crusher product is then transferred to a diverter chute which will distribute the material into two streams that feed two cone crushers feed bins in parallel.

The cone crusher feed bins discharge will be withdrawn using cone crusher vibrating feeders (100-FE-02/03) into the cone crushers. The cone crushers have a CSS of 32 mm, with an expected product  $P_{80}$  of 40 mm. The cone crusher product will be fed to a screen in which the oversize is directed to the primary crusher discharge conveyor and recycled to cone crusher feed bins whilst the undersize is conveyed to a crushed ore stockpile via a screen undersize discharge conveyor.

The crushed ore stockpile is reclaimed and conveyed to a HPGR feed stockpile locating at the processing plant by a long distance conveyor.

The HPGR feed stockpile ore is reclaimed via apron feeders and stockpile discharge conveyors. The ore is then transferred via the HPGR feed conveyor and is discharged onto a diverter chute to feed the grinding circuit. The tertiary crushing circuit consists of two high



pressure grinding rolls (HGPR) in parallel. The diverter chute will distribute the ore into two HPGR feed bins. The HPGRs will then be fed via vibrating feeders via a conveyor belt with a metal detection system to protect the roll surface from tramp metal damage.

The HPGR target crush size is 5 mm. The product is in closed circuit with two double deck banana screens and produces two size fractions. The oversize material is recycled back to the HPGR feed conveyors and the undersize fraction stream reports to agglomeration through the screen undersize discharge conveyor.

HPGR introduces micro-cracking that improves leach kinetics, allowing for maximum metal extraction during the heap leach process.

### **15.2.2 Crushing and Ore Handling - 20 Mtpa**

Run of Mine (ROM) ore is transported by truck from the mine and is discharged into a ROM bin, which feeds to a primary crusher. The primary crusher is a gyratory crusher suited to higher crushing capacities. The closed side setting (CSS) of the gyratory crusher is expected to be set at 177 mm with an assumed  $P_{80}$  of 150 mm to be produced. The output of the gyratory crusher is discharged into a surge vault where it will be directed to a primary crusher discharge conveyor via an apron feeder. The gyratory crusher product is then transferred to a tripper feed conveyor which will distribute the material into five secondary crusher feed bins in parallel.

The cone crusher feed bins discharge will be withdrawn using the cone crusher vibrating feeders feeding into the cone crushers. The cone crushers have a CSS of 25 mm, with an expected product  $P_{80}$  of 31 mm. The cone crusher product will be fed to three screens in which the oversize is directed to the primary crusher discharge conveyor and recycled to cone crusher feed bins whilst the undersize is conveyed to a crushed ore stockpile via a screen undersize discharge conveyor.

The crushed ore stockpile is conveyed to a HPGR feed stockpile locating at the processing plant by a long distance conveyor.

The HPGR feed stockpile ore is reclaimed via apron feeders and stockpile discharge conveyors. The ore is then transferred via the HPGR feed conveyor and is discharged onto a diverter chute to feed the grinding circuit. The grinding circuit is consisted of two HGPRs in parallel. The diverter chute will distribute the ore into two HPGR feed bins. The HPGRs will then be fed via vibrating feeders.

The HPGR target crush size is 5 mm. The product is in closed circuit with four double deck banana screens and produces two size fractions. The oversize material is recycled back to

the HPGR feed conveyors and the undersize fraction stream reports to agglomeration through the screen undersize discharge conveyor.

HPGR introduces micro-cracking that improves leach kinetics, allowing for maximum metal extraction during the heap leach process.

### **15.2.3 Agglomeration Drum**

Agglomeration improves the permeability of the heap and facilitates even acid flow without pooling and increasing the amount of oxygen available for reaction. Additionally, pre-wetting will reduce the losses of fines from the wind and increase the leaching kinetics of the ore. Heap leaching requires good percolation throughout the heap to ensure maximum metal recovery is realised. Clays and fine particles can hinder solution flow through the heap, and the ore is often agglomerated to overcome this issue. It is considered essential to undergo agglomeration prior to heap leaching to ensure good metal recovery.

The undersize particles from the HPGR are combined with binder, sulfuric acid and water to agglomerate the ore into clumps. The binder is added to the agglomeration drum in solution form.

### **15.2.4 Heap Leach**

The ore will be stacked by grasshopper conveyors and inclined conveyor stackers, producing a heap pile. This is a preferred stacking method due to conveyor stacking being able to reduce ore segregation which allows for increased permeability. Due to the use of sulfuric acid the conveyor edges must be moulded, open edge belts will severely corrode. Additionally, it is preferable to splice the conveyor belt instead of using clips as it reduces spillage and belt stress.

Drippers are used primarily in arid environments due to the substantially reduced evaporation in comparison to heap sprays. The drip lines are buried 10 cm to 50 cm beneath the surface of the heap to minimise evaporation. The irrigation rate will be approximately 10 L/h/m<sup>2</sup>. The primary heap pad will be irrigated with solution from the intermediate leach solution (ILS) pond. The secondary and the wash heap pad will be irrigated with solution from the barren pond.

The pad will require a double liner (HDPE) to minimise any possible loss of liquid from liner punctures. Due to the high evaporation rate in the area and close proximity of a river, a compacted impermeable clay layer in conjunction with necessary leakage detection systems will be used to minimise risk of the heap solution entering the environment.

Pipe heat exchangers utilising solar energy are used to ensure that the irrigation solutions are maintained at the desired temperature. A forced aeration system is also used in the heap design to ensure that sufficient oxygen/air is supplied to the heap for bacterial activities.

### **Primary Heap**

The primary heap will consist of fresh ore from the agglomeration drum that is stacked using conveyors and irrigated from the intermediate leaching solution (ILS) pond. The ILS pond will contain a low concentration leached solution from the secondary pad. The primary heap is leached for 120 days and the pregnant leach solution (PLS) from the primary heap is collected in the pregnant solution pond. The leached ore then becomes the secondary heap by re-routing the flow of the particular piping.

### **Secondary Heap**

The secondary heap will be irrigated from the barren solution pond. The barren pond solution contains leftover metal sulfates from the solvent extraction raffinate. The ILS from the secondary heap is collected in the ILS pond after the ore is spent. The spent ore becomes the washing heap by re-routing the flow of particular piping.

### **Washing Heap**

The washing heap will be irrigated with solution from the barren pond. This ore is washed with solution through drip irrigation periodically (can be conducted over several years). The solution from the heap is collected in the barren pond and used for leaching of the secondary heap.

#### **15.2.5 PLS Clarification**

Several operations have installed pinned-bed filters on the PLS streams and have been effective. There are examples where the total suspended solids are consistently reduced to <20 mg/L. This is effective, as the uncontrolled separation of solids from the process liquor is usually a significant contributor to crud formation.

#### **15.2.6 Crud Treatment**

Crud formation at the interface of the aqueous and organic phases is a common issue for solvent extraction which will lead to loss of organic and lower metal extraction efficiency. Crud treatment using clay and diatomaceous earth has been included in the process to optimise organic recovery and quality. The recovered organic is recycled back to the solvent extraction process and the spent clay is transferred to a storage drum which will be sent to disposal.

### 15.2.7 Copper Solvent Extraction/Electrowinning

The copper solvent extraction (SX) circuit will consist of two extraction cells and two stripping cells. Two extraction cells are used due to the high concentration of copper in the solution to extract as much copper into the organic phase as possible.

Solvent extraction works by combining an organic extractant with an aqueous acid leaching solution at a favourable pH to transfer metal ions of interest into the organic phase. The copper depleted aqueous phase, referred to as the raffinate, is sent back to the leach circuit. The extraction of copper from dilute sulfuric acid is pH dependent with most copper SX being performed at a pH of 2. Due to the similarities in acid dissociation constants, the iron in solution will have to be monitored and subsequently removed to improve the copper grade in the end product.

#### Extraction

In the extraction stages the PLS solution is mixed with an organic diluent (usually a kerosene type organic solvent) containing an organic compound called an “extractant”. The extractant releases its protons and coordinates with copper, transferring the copper from the aqueous phase to the organic phase as an extractant complex. The protons released increase the acid level.

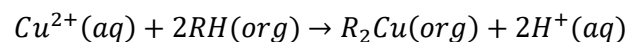

Where,

$Cu^{2+}(aq)$  - is copper ions in solution

$RH(org)$  - is the extractant, i.e. fresh or recycled stripped organic

$R_2Cu(org)$  - is the copper/extractant, i.e. loaded organic

$2H^+(aq)$  - is acid in the raffinate solution

#### Stripping

Stripping is accomplished by contacting the copper containing (loaded) organic with relatively strong sulfuric acid. In most cases, an excess acid concentration of approximately 150 g/L  $H_2SO_4$  is required to maintain adequate stripping. Spent electrolyte from electrowinning (containing copper) may be used as the stripping agent, and the copper content can be increased to any desired level up to about 100 g/L Cu for use as a strong electrolyte. Stripping of copper occurs only when strongly acidic solution is mixed with the

organic copper complex. The complex releases its copper and takes on acid, according to the following reaction.

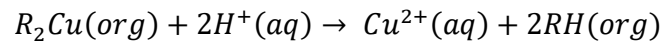

### Product

The stripped copper sulfate solution will be converted to copper metal via electrowinning. The copper electrolysis process involves electroplating of copper from copper sulfate onto a cathode. This is carried out by passing a current from an inert anode through the solution which causes the copper to plate out on the cathode. The spent solution from copper electrowinning is sent to the stripping liquor tank and then to the strip liquor makeup tank. The cathodes loaded with metallic copper will then be washed in a cathode washing tank. The washed cathodes are sent to a flexing station and a stripping station to release the metallic copper from the cathodes while the washing water will be directed to the barren pond. The metallic copper is transferred to a strapping station and a weighing station where it will be palletised and weighed prior to transport.

The copper sulfate solution can alternately be sent to an evaporative crystalliser where the water is drawn off to leave behind a saturated copper sulfate solution with copper sulfate crystallising as a pentahydrate ( $CuSO_4 \cdot 5H_2O$ ). This is continuously done and refluxed to obtain a high level of saturation which is sent to a centrifuge to collect the copper sulfate solids product. The solution is recycled back into the strong electrolyte tank for recycle and subsequent recovery of the contained copper. The solid product is sent to a flash dryer where water is evaporated and the product is then collected into the product bin. The dried copper sulfate pentahydrate will then be bagged into 1 tonne bulka bags on pallets.

### 15.2.8 Iron and Aluminium Precipitation

Iron and aluminium in the ore is approximately 1.8% and 7% respectively which will build up as the process continues. The iron and aluminium build up in the solution needs to be treated before recycling the SX raffinate for heap leaching. The process involves pumping the bleed stream of the solution from the copper raffinate return line into the iron precipitation tank where limestone and lime is added to adjust the pH. Iron will be present primarily as iron sulfate ( $FeSO_4$ ) which when reacted with lime will produce iron hydroxide ( $Fe(OH)_2$ ). Additionally, aluminium will also be present as a sulfate ( $Al_2(SO_4)_3$ ) and will produce an oxide when precipitated. At an elevated pH (5.8-6.0) the hydroxide will precipitate out of solution as a red insoluble oxide. This will be transferred to the iron tailings thickener where the oxide is collected, filtered and disposed of by dry stacking. The thickener overflow will be sent to

the raffinate recycle tank and then will be pumped into the barren solution pond where it can be recycled to the heap leach pad.

### **15.2.9 Water Distribution**

Water distribution covers the raw water dams and process water tanks. These will supply general plant water as well as a feed for potable water, fire water, gland seal water, reagents makeup, dust suppression as well as cooling and heating water.

#### **15.2.10 Reagents**

Reagents are mixed in an open area in covered tanks to prevent rain from damaging or reacting with the dry chemicals. The design incorporates accepted methods for mixing, holding, solution distribution and ventilation for each chemical according to their individual SDS and common industry practice. Reagents are kept in a warehouse until they are required. Containment bunds and sump pumps are required for individual reagent handling areas. The sump pumps feed any spilled reagents into the respective tank depending on reagent area. The reagents area will provide storage and distribution for quicklime, limestone/calcrete, sulfuric acid, solvent extraction reagents, electrowinning reagents, crud treatment clays, flocculant and binder.

#### **15.2.11 Services**

A services area will include air distribution (both instrumentation and process air), potable water production using a reverse osmosis package and heavy fuel oil distribution.

A detailed process description outlining each area for whole ore heap leaching and all related equipment can be seen in Appendix C.

## 16. PROJECT INFRASTRUCTURE

### 16.1 Mine Area Power Requirements

The current Project site power requirement estimates are shown in Table 16-1:

**Table 16-1: Power requirement for each scenario**

Plant Option	kWh/t	Installed Power (kW)	Power Draw (kW)
Option 1	11.66	15,036	12,958
Option 2	14.94	18,921	16,475
Option 3	11.96	15,400	13,286
Option 4	11.04	33,227	28,788
Option 5	12.52	37,376	32,523
Option 6	11.36	34,105	29,579

### 16.2 Mine Area Buildings

The pit mine site itself is located in a very rugged and steep area. Therefore, the cost of construction of the processing plant and heap leach pad nearby to the pit mine might be high. However, the mine area buildings required will depend on the processing option chosen.

The crushing plant will be constructed near to the pit mine site. ROM will be transported from the mine to the ROM stockpile area near the crushing plant. The material from the stockpile will feed the crushing plant. The crushed ore is transferred to the processing plant.

The processing area consists of the agglomeration plant, heap leach area, pond area, recovery plant, workshop and offices as shown in Figure 16-1. It will be located in flat area, approximately 4.5 km northwest of the mine. Thus, a 4.5 km conveyor will be necessary to transfer the material to the processing area. It is foreseen that this will be a pipe conveyor to minimise dust losses.

The heap leach area will accommodate the primary, secondary and washing heaps. The design of the heap leach pad is determined by various factors such as slope stability, seismic stability, amount of space available and climate. In the pond area are the pregnant leaching solution pond (PLS), the intermediate leaching solution pond (ILS), barren leaching solution pond (BLS) and the process water pond. The metal recovery plant consists of the solvent extraction, electrowinning and crystallisation facilities.

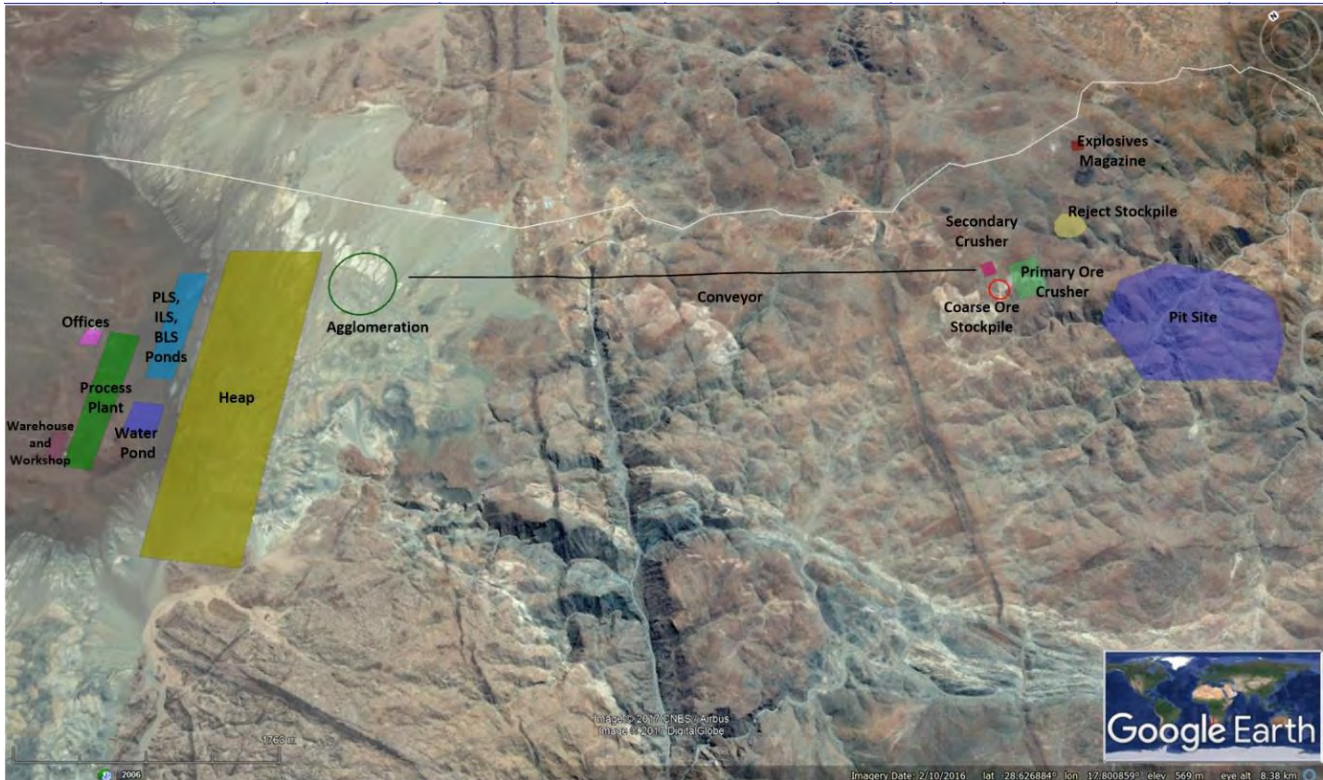

**Figure 16-1: Mine site layout**

### 16.3 Explosives Storage

In Namibia, criteria apply to the possession and storage of explosives to ensure storing explosives without creating an unacceptable risk to the community and to the employees. Thus, a licence is required to possess and store explosives as prescribed by the Explosives Act 1956 and Regulations (GNR 1604 of 8 September 1972). Application for a licence shall be made to the chief inspector of explosives, who may issue such a licence subject to the observance of the regulations and after consultation with the local authority.

Design and location of a magazine for the storage of explosives will depend on the explosive category, quantity and distance to buildings such as railways, roads, dwelling-houses navigable water. Table 16-2 specifies distances that shall form the basis on which applications for magazine for storage of explosives licences must follow.



**Table 16-2: Distances requirements (all in metres) to build a magazine for storage of explosives**

Net explosives	25- kilogram cartons	To other magazines			To railways, roads, open sports- ground, navigable water, or dwelling-house in same ownership as magazine and occupied by the owner or an employee			To other dwelling-houses or public buildings*		
		Cat. X Mounded or un-mounded	Cat. Y mounded or un-mounded	Cat. Z or ZZ mounded	Cat. X mounded or un-mounded	Cat. Y mounded or un-mounded	Cat. Z or ZZ mounded	Cat. X mounded or un-mounded	Cat. Y mounded or un-mounded	Cat. Z or ZZ mounded
500 .....	20	9	12	19	15	25	47	31	50	95
750 .....	30	9	13	22	17	29	61	33	57	122
1 000 .....	40	9	14	24	18	32	75	36	63	150
1 250 .....	50	10	15	26	18	34	85	37	68	170
2 500 .....	100	13	18	32	21	43	130	42	86	260
5 000 .....	200	17	21	40	23	54	180	46	108	360
10 000 .....	400	21	28	50	25	68	235	50	136	470
12 500 .....	500	23	30	55	26	73	255	52	146	510
15000 .....	600	24	33	58	27	78	270	54	156	540
20 000 .....	800	25	37	65	28	85	300	55	170	600
25 000 .....	1 000	26	40	70	29	90	320	57	180	640
30 000 .....	1 200	27	45	75	30	100	345	60	200	690
40 000 .....	1 600	27	50	80	30	110	380	60	220	760
50 000 .....	2 000	27	55	85	30	115	400	60	230	800
75 000 .....	3 000	27	65	100	32	135	470	65	270	940
100 000 .....	4 000	27	75	110	33	145	510	65	290	1 020
150 000 .....	6 000	27	90	125	35	170	590	70	340	1 180
200 000 .....	8 000	27	95	135	35	180	640	70	360	1 280

Category X: Explosives having fire or slight explosion risk or both, with only local effect.  
 Category Y: Explosives having mass fire risk, or moderate explosion risk, but not mass explosion risk. Category Z: Explosives having mass explosion risk with serious missile effect.  
 Category ZZ: Explosives having mass explosion risk minor missile effect. Source: GNR 1604 of 8 September 1972, Namibia.

The Haib deposit has suitable areas to build a magazine since the surrounding area is unoccupied and the nearest settlement is 12 km away from the Haib deposit.

#### 16.4 Waste Dumps

Suitable and sufficient areas for recovery plant, waste dumps and heap leach pads are available within the EPL area but the chosen sites will be dependent on the eventual mine and plant design. The area of the property and surrounding remainder of the farm is state land and currently only used for emergency stock grazing purposes under lease from the State so mining will not conflict with any formal farming activities.

#### 16.5 Power

##### 16.5.1 Power in Namibia

For all modern energy (petroleum products and electricity), Namibia is still highly dependent on external supply. Namibia does not have any indigenous sources of oil, coal or natural gas although there are prospects for commercial exploitation of natural gas, there are no

domestic oil refineries and as a result, all refined petroleum products are imported. With regard to electricity, Namibia, to a large extent, relies on energy imports. The country imports most of its electricity supply from South Africa and Zimbabwe.

Namibia's average consumption rate surpasses 3000 GWh/year, while its generation capacity is around 1305 GWh/year. Therefore, there is a supply gap, which is covered by importing power from South-Africa, Zambia, and Mozambique. For these reasons, coupled with the low population density there currently around 1 million Namibians whom lack access to electricity, which equates to almost half of the country not having access to electrical energy.

Namibia's top energy sources are petroleum, hydropower, imported electricity, and imported coal. The country's internal resources supply less than one-third of its domestic energy requirements.

Namibia's generated electricity is produced from:

- The 240 MW hydroelectric power plant on the Kunene river in Ruacana;
- The 120 MW van Eck coal-powered plant north of Windhoek;
- The 22.5 MW ANIXAS Power Station;
- The Paratus 24 MW heavy fuel-oil powered plant in Walvis Bay; and
- The 5.78 MW solar plant in Trekkopje in the Erongo region.

Although progress has been made to expand investment in domestic energy generation transmission and distribution, the situation will remain critical in the next 5 years as Namibia must import power from a region that has already insufficient power. As a result, increase in the import prices of electricity is expected to continue given the prevailing electricity shortage in the region.

Currently, installed electrical generation capacity is insufficient to meet domestic demand. Therefore, Namibia is importing large amounts of electricity from neighboring countries, predominantly South-Africa. The cross-border transmission lines have a capacity of 600 MW. Another transmission line is currently being built, extending the transmission system to Zambia and Zimbabwe and will have an additional 600 MW of capacity.

### **16.5.2 Alternative Energy Sources**

Namibia has high potential for solar, wind and biomass generation. Bush invasion is widespread in the country's north, which allows for potential large scale bioenergy-based production. The country is also noted for its high uranium resources which currently accounts for approximately 8.2% of the global uranium production each year.

With regard to renewable energy, their relative share in the total primary energy supply (TPES) is particularly high; traditional biomass contributed for 64% of the TPES in 2009. The key challenge is therefore to ensure the sustainability of biomass resources to meet the household demand for the basic energy needs of cooking and space heating. Interventions to increase energy efficiency along the biomass supply chain and penetration of low carbon technologies will be major drivers to increase access to modern energy services and to preserve dense forestry and other biomass resources.

Hydropower is the other major source of renewable energy currently exploited on a large scale. 98 % of the electricity generated in the country came from hydro power in 2011, however given its fluctuating supply issues, energy security is still negatively impacted with an increasing reliance on external power transmission. This trend could be reversed if the potential for solar and wind power production, on grid and off grid, for households and businesses, is exploited. However, the lack of national renewable energy targets and/or other measures to facilitate the introduction of carbon-neutral generation capacity is a major constraint to the deployment of renewable energy sources.

### **16.5.3 Future Outlook**

The major challenge for Namibia's power remains access to modern energy services for rural areas. Although investments were devoted to local energy production and rural electrification, access to electricity and other modern energy services remain low in rural areas. In 2012, rural households still relied heavily on biomass for their basic energy needs and the rate of rural electrification did not exceed 25%. Considering the situation of deforestation in large parts of Namibia, there is a need to improve this situation particularly with energy efficient technologies and the deployment of modern forms of energy.

Namibia also faces;

- Increasing reliance on imports from South Africa-Zimbabwe and lack of domestic development for a secure power supply
- Increasing prices for liquid and gas fuels;
- A regulatory and financial framework not sufficiently attractive to invest in renewable technologies which bear high initial capital cost
- The long gap time required in building new power plants particularly from renewable energy sources to meet the increasing demand.
- The country's low population density coupled with the high domestic energy use in urban areas and long transport routes to the country and between the few major centres within Namibia

The following will be integral for the above issues to be addressed and for Namibia to continue to improve its energy sector and security:

1. Improved quality of workforce, predominantly in skilled areas such as engineering
2. Government incentives and national targets for developing and improving its energy sector. Such as the establishment of the Renewable Energy and Energy Efficiency Institute (REEEI) and the Electricity Control Board (ECB) which has been promoting energy efficiency, and demand side management.
3. Increased government allocation to developing its domestic generation capacity
4. An improved business model and guidance from the government to provide off-grid, small-scale solutions for the rural areas. Improved financial and regulatory framework, investment into manufacturing alongside an improved and updated database to provide information for potential local and foreign investors.

**16.5.4 Power Transmission Lines**

Transmission lines have been introduced to increase power to the grid in Namibia from both Angola and Zimbabwe through the Angola-Namibia Transmission Interconnector (400 kV) and the Caprivi LINK HVDC Interconnector (350 kV). As stated above, although there are developments and initiatives in place to improve Namibia’s domestic generation capacity they are still heavily reliant on external sources of power supply through these interconnections.

**Figure 16-2 Geographical Location of the Caprivi Link Interconnector**

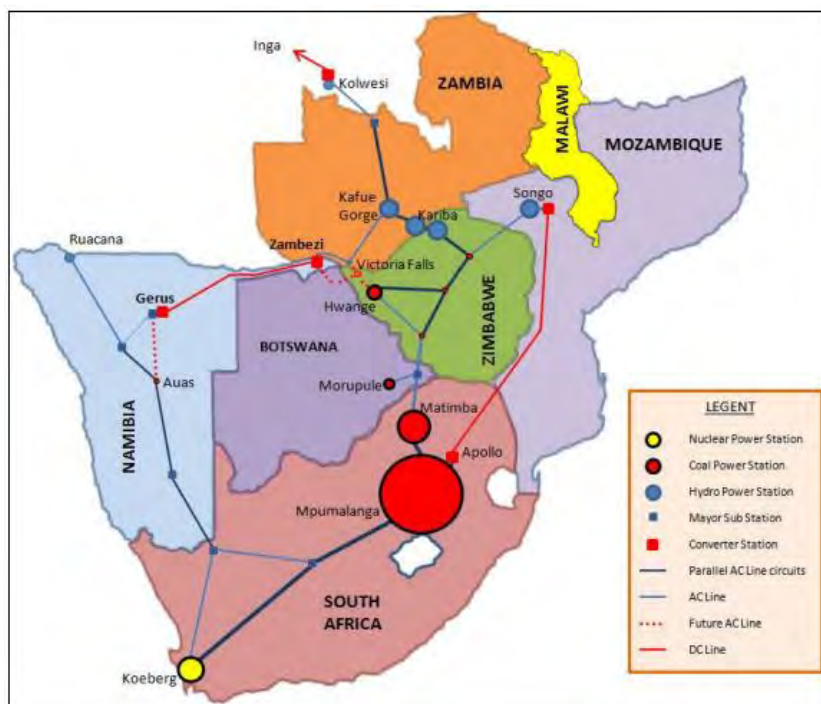

Historically, the government does allocate substantial resources to the development of mining operations. However, further investigation would be required to assess if the predicted 33 MW demand of the processing facility and associated utilities would surpass the capacity of the local transmission lines. Once the project has been sufficiently defined it is proposed that NamPower be consulted for advice on how to proceed.

The main north-south national power grid lines have been identified as 85 km to the east of the Haib project area (Figure 16-3). There is potential for a link to be developed to provide power given the capacity is available. Required substations or transmission lines could be installed by NamPower and potentially included in the tariffs. An investment in solar energy could be considered reduce power costs and help NamPower provide consistent supply to nearby rural areas supplementing excess energy back into the grid. There may also be potential to subsidise the significant upfront capital costs through government incentives (they currently offer subsidised loans for renewable energy technologies – Solar Revolving Fund) and have shown interest in supporting mining operations in the past to support the economy.

The financial model is currently based on a commercial unit charge of 116.81 c/kWh (0.084 USD/kWh) sourced from the NamPower 2019/2020 tariff schedule.



**Figure 16-3: Power Line Transmission and Substations in the South of Namibia.**

**Source: Nampower Annual Report 2016**

### 16.5.5 Estimated Consumption

Estimated power demand and operating duration is shown below for Options 1 to 6. At this stage it is assumed the maximum power draw will be the listed power draw in Table 16-3. This assumes that equipment with high power draws such as the crushers / HPGR use a

soft starter to reduce torque in the motor and allow smooth progression of current while reducing the impact voltage.

**Table 16-3 Power Demand Summary**

	Option 1	Option 2	Option 3	Option 4	Option 5	Option 6
<b>Installed Power (KW)</b>	15,036	18,921	15,400	33,227	37,376	34,105
<b>Power Draw (kW)</b>	12,958	16,475	13,286	28,788	32,523	29,579
<b>Consumption (kWhpa)</b>	99,077,860	126,977,233	101,663,914	220,906,798	250,350,674	227,143,346

## 16.6 Water

The Haib deposit straddles the Volstruis River (meaning the Ostrich river in Afrikaans), which is a tributary of the Haib River. Both are ephemeral tributaries of the Orange River which lies south of Haib.

The major water source is from the Orange River which is located about 15 kilometres by pipeline south of the main Haib deposit. However due to the river being a shared resource between more than one country, there are regulations that apply and future demand upstream may lessen the available water supply.

The Orange River is a deeply incised drainage with several nick-points. Haib lies below all of the main nick-points at a location where the Orange River elevation is approximately 200 metres above sea level.

The banks of the Orange River downstream of Vanderkloof Dam are heavily developed in many areas, principally for irrigation purposes. Both the Gariiep and Vanderkloof dams are used to regulate the river flow for irrigation as well as to produce hydro-electricity during peak demand periods. Very little Orange River water is used for domestic or industrial purposes with the exception of that used in the Vaal River basin.

Very limited volumes of groundwater are available in the basement rocks of the southern Karas Region, since there are no productive aquifers. Lack of recharge and poor groundwater quality in most areas further aggravates the situation.

The concept is to have a pump station near Noordoewer and pump 15 km to the process plant. The pump station would consist of two electric pumps (duty/standby) with suction legs into the Orange River. The electric motors and pumps would be sized for the duty plus static head and friction head in future studies. Power for the pumps would be off the local town power supply. The mass balance requires 160 to 370 m<sup>3</sup>/hr of process water for the 8.5 Mtpa and 20 Mtpa cases and this would require a 150 mm poly pipe butt welded from the pump station to the process plant water pond. The pipe would be laid on the surface and

snaked along a graded route. The actual route and permitting approval has been assumed at this stage. The pipe length and routing will need to be optimised in future studies.

The control of the pump station at Nordoewer would be by telemetry from the process plant.

## **16.7 Water Management Pond**

The Karas Region, where the Haib deposit is located, is an arid zone with low and erratic rainfall of about 50-100 mm/a, which can occur in the summer and winter seasons. Additionally, loss of water through evaporation only worsens the situation. Reliable water supply will therefore be critical for the successful and efficient operation of the mine.

Based on the evaluation of water for the project, 160-370 m<sup>3</sup>/h (depending on the selected throughput and final products) would be required. The key source of water will be the Orange River and the water recovered from tailings through the dry stacking process. The proposed water supply for the Haib project will mainly consist of two raw water ponds and three process water tanks locating at the mine site and the processing plant. Raw water will also be used for dust suppression in the pit and on haul roads.

### **16.7.1 Mine Site**

The mine site which includes the mine pit, ore crushing, handling and stockpiling areas, is located approximately 4.5 km away from the processing site. On the mine site there are pit dewatering bores which will pump water to a small plastic lined pond. The quantity of water recovered from the pit is unknown. Given the arid and erratic climate the pit could be dry or has a small amount of water. Additional water may be required from the Orange River to supply water mainly for dust suppression purposes. Based on mining studies these capital works could be delayed.

### **16.7.2 Processing plant**

The processing plant will have a raw water plastic lined pond and water tanks for distribution of water to plant reagents, ablutions, workshops and assay facilities. Water primarily sourced from the Orange River will be pumped to the dam through the 15 km pipeline. The dam will also collect water recycled from the processing plant. Water from the dam will then be pumped to process water tanks to be used as process water, fire water, heating and cooling water, service and gland water.

The barren and pregnant ponds in the heap leaching area which are also assumed to be HDPE plastic lined with a nominal size will be supplemented from the process water pond.

A small reverse osmosis will process water for storage in a small potable water tank to distribute potable water to the mine site and processing plant for safety shower.

Based on the mass balance the loss of water will be due to evaporation and retained water in the heaps. A more detailed water balance will be undertaken in future studies. The sizing of tanks and ponds is assumed based on the current mass balance and will need to be optimised when the water balance of the project is better understood.

## **16.8 Telecommunication**

Namibia has one of the most modern and sophisticated backbone infrastructures in Africa. Fibre optic cables are connected throughout the length of the country on the north-south and west to east axis. The countries telecommunications regulator is the Namibian Communications commission (NCC) working under the Namibian Communications Act of 1992. Telecom Namibia runs the largest Telecommunication network in Namibia.

A site telephone system will be used to connect together through various parts of the operation. Two-way radios will be used for communication between supervisors, mobile equipment operators, crusher operators and conveyor operators.

To facilitate the plant control system and communication between process areas, a wire network will be installed around the site.

## **16.9 Workforce Accommodation**

The closest towns near the Haib deposit are Noordoewer and Viooldrift with a total population of approximately 5000. The towns are 5 km apart and are about 25 km west of the Haib deposit. Basic infrastructure including hospital, medical clinic, hotels, petrol station, shops, taxi services, buses, police station and border control have already been established in the area.

The camp site for workforce accommodation can be constructed at either Noordoewer or Viooldrift which will allow the project to share the existing infrastructure and reduce the project costs.

## **16.10 Workshop and Offices**

Site maintenance workshop/warehouse will be constructed on site to facilitate the maintenance of processing equipment and mobile equipment as well as to provide storage room for equipment spares.

Administration office building, laboratory and store will be constructed to accommodate personnel from plant operations, maintenance, mining operations, management and administration.



## 16.11 Buildings

The buildings will be built using locally made concrete blocks on site. We have also considered pop up tilt slab now being used at remote mine sites. There will be a construction crushing plant and batch concrete plant used for this. There is suitable hardrock for aggregate and sand from the local river beds to be used for this purpose.

Transportables will also be considered as alternatives for future studies.

The project will require the development of the following infrastructure items (Table 16-4) in order to operate:

**Table 16-4: Building required at Haib project**

Building	Description
Camps	Will provide accommodation for management, workforce and visitors. This could be in Nordoewer as it benefits from existing local infrastructure.
Crusher Control Room	Will provide a working space engineers.
Reagent Shed	Will provide storage for reagents.
Canteen	Will provide area for cooking and dining facilities.
Metallurgical Laboratory	Laboratory to perform metallurgical testwork.
Assay Laboratory	Will provide laboratory equipment.
Open Area Storage	A fenced-off open storage area for equipment and materials that can be stored outside.
Maintenance/Warehouse	A facility will provide service the mobile equipment and for storage of equipment spares.
Control Room	Will provide working space geology, engineering, and other operations support staff.
Office building	Will provide a working space for management, supervision.
Security Gate House	Will provide access control and security to the project.
Medical Centre	Will provide first aid services and emergency care.

## 16.12 Roads

Roads located near the deposit are well established and of sufficient quality (Figure 16-4). The deposit is located next to a main road that connects Namibia to South Africa, which is well maintained and suitable for large freight trucks. The road on the Namibian side is named Rundreise Namibia or state road B1 that extends from the North of Namibia at Oshikango to the South at Vioolsdrif. The only road construction required would be an upgrade to the existing 12 km long access road to site.

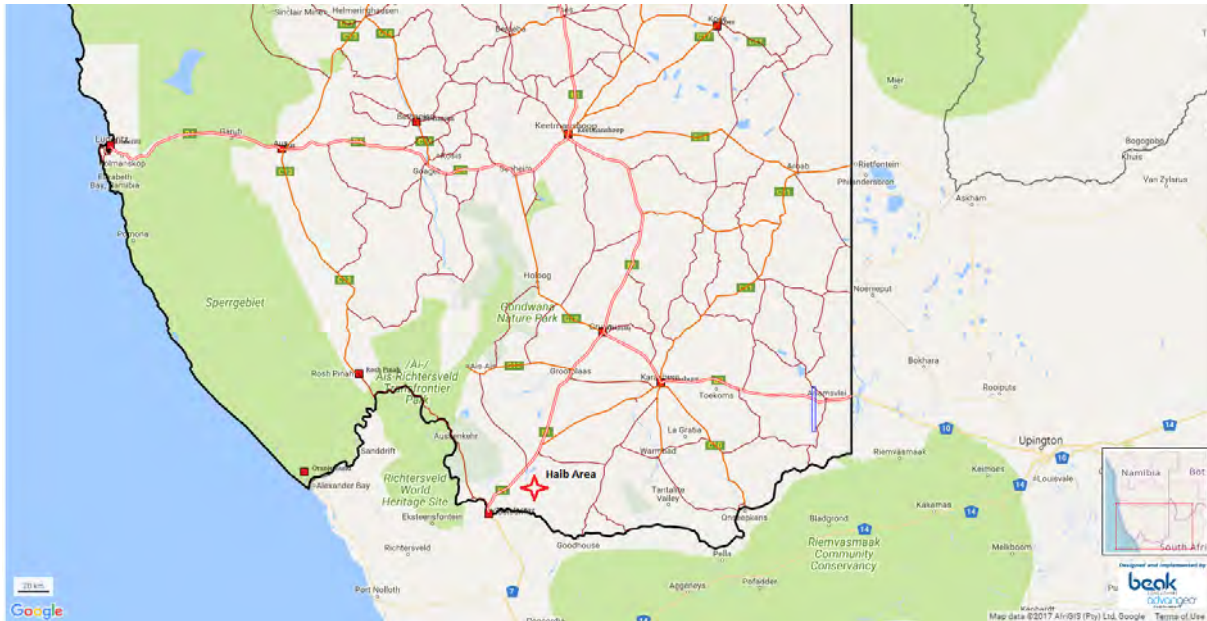

**Figure 16-4: Roads close to Haib project. Source Google Maps, 2017**

### 16.13 Air Services

The airport of Oranjemund is located on the South West corner of the Namibian border at approximately 250 km from the deposit and has the appropriate services already established to transport the required personnel. The Keetmanshoop Airport located 300 km from the deposit is the biggest airport in the Karas region in southern Namibia. It is situated 5 km outside the town of Keetmanshoop.

Additionally there is the airport of Springbok in South Africa located 157 km from the deposit. Another option is the Kleizec Airport located in South Africa. Its distance to the Haib area is 224 km.

A local airstrip has not been included onsite and would add another US\$4M if included.

### 16.14 Railways

The nearest railway station is located at the town of Grunau, some 120 km north on the main highway (Figure 16-5).

The area between the Haib and Grunau is almost completely flat and the local rail authority has confirmed that a link could be laid relatively easily; this would provide access to either the port of Luderitz or the port of Walvis Bay via Windhoek. Considering the available rail network in Namibia, the distance from Grunau to the port of Walvis Bay by rail is about 1200 km and 600 km to the port of Luderitz.



**Figure 16-5: Railway network nearby to Haib deposit showing the ports of Luderitz and Walvis bay.**

**16.15 Ports**

Walvis Bay is Namibia's largest commercial port that is located approximately 1200 km away from the Haib deposit. It is located half way down the coast of Namibia, with direct access to principal shipping routes. Walvis Bay is a natural gateway for international trade and is a sheltered deep-water harbour benefiting from a temperate climate. The long freight distance will incur significant costs for both import of raw materials and product export.

An alternative and preferable port that could be used is the port of Luderitz. It is located on the south-west coast of Namibia approximately 600 km away from the Haib deposit. Traditionally, Lüderitz has been a fishing port, serving the needs of the Namibian fishing industry at a national level. The port is also an important shore base for oil and gas drilling operations off the southern coast and has also catered for the needs of the offshore diamond industry.

The rail connection could provide access to either the port of Luderitz or to Walvis Bay via Windhoek.

## **17. MARKET STUDIES & CONTRACTS**

### **17.1 Copper**

Copper is the main product that will be obtained from the process which will exist in the form of copper metal from electrowinning.

#### **17.1.1 LME Copper**

Copper is one of the most widely used metals on the planet. China, Europe and the USA are the main global consumers of copper. Copper will be produced on the cathode of the electrowinning cell as pure sheets which will be a pure (99%) solid. Pure copper metal is used for a variety of purposes. The major use is electrical wiring due to the great electrical conductivity of copper. Additionally, copper is used in many metal alloys such as brass and bronze which are stronger and more corrosion resistant than pure copper. Copper prices of \$2.00/lb, \$2.25/lb, \$2.50/lb, \$2.85/lb and \$3.00/lb were incorporated in this economic analysis.

#### **17.1.2 Copper Sulfate**

Copper sulfate will be sold as a blue powder when the crystals are crushed and dried. Copper sulfate is used in multiple industries such as arts, mining, chemical, pharmaceutical, healthcare and agricultural. The biggest use is for farming as an herbicide or fungicide as it can be used to control fungus on grapes, melons and berries. Additionally it inhibits the growth of E-Coli. Other uses include analytical reagents and past use as an emetic and dyes. In the healthcare sector, it is used in sterilisers and disinfectants. Industrial usage could be in adhesives, building, chemical, textiles industries, etc. where it is used to manufacture products like insecticides, wood preservatives and paints.

The Asia-Pacific region is the biggest consumer of copper sulfate due to the presence of large agricultural and animal husbandry industries. Other major consumers are North and South America and Europe. The main importers are listed as the United States with one fifth of the total global import volumes followed by Australia, Indonesia and the Netherlands.

High purity copper sulfate has a 25% premium price based on the copper content in the sulfate. The following copper sulfate pentahydrate prices have been used in the economic analysis based on the different copper prices:

- At US\$ 2.00/lb of copper, US\$ 0.64/lb copper sulfate pentahydrate
- At US\$ 2.25/lb of copper, US\$ 0.72/lb copper sulfate pentahydrate
- At US\$ 2.50/lb of copper, US\$ 0.80/lb copper sulfate pentahydrate

- At US\$ 2.85/lb of copper, US\$ 0.91/lb copper sulfate pentahydrate
- At US\$ 3.00/lb of copper, US\$ 0.95/lb copper sulfate pentahydrate
- At US\$ 3.25/lb of copper, US\$ 1.03/lb copper sulfate pentahydrate
- At US\$ 3.50/lb of copper, US\$ 1.11/lb copper sulfate pentahydrate
- At US\$ 3.75/lb of copper, US\$ 1.19/lb copper sulfate pentahydrate
- At US\$ 4.00/lb of copper, US\$ 1.27/lb copper sulfate pentahydrate

The copper sulfate production was capped at 50,000 tonnes of copper sulfate pentahydrate (32,000 tonnes of anhydrous copper sulfate). According to a recent market study published by IMARC, the global copper sulfate market is expected to be more than 400,000 tonnes per annum by 2022. At the proposed production cap of 32,000 tonnes of anhydrous copper sulfate equivalent, this would represent approximately an 8% market share.

## **18. ENVIRONMENTAL, PERMITS, SOCIAL OR COMMUNITY IMPACT**

### **18.1 Baseline Study**

A multidisciplinary site survey is conducted prior to or in the initial stage of a joint operational deployment. The survey documents existing deployment area environmental conditions, determines the potential for present and past site contamination (e.g., hazardous substances, petroleum products, and derivatives), and identifies potential vulnerabilities (to include occupational and environmental health risks).

Surveys accomplished in conjunction with joint operational deployments that do not involve training or exercises (e.g., contingency operations) should be completed to the extent practicable consistent with operational requirements.

### **18.2 Environmental Management Plan**

The following draft Environmental Management Plan (EMP) details the measures to be adopted to address identified impacts during the construction and operational phases of the Project. The EMP details:

- Environmental elements – the environmental aspects requiring management consideration;
- Potential impacts – potential impacts identified in the EIS;
- Performance objective – the target or strategy to be achieved through management;
- Management actions – the actions to be undertaken to achieve the performance objective, including any necessary approvals, applications, and consultation;
- Performance indicators – criteria against which the implementation of the actions and the level of achievement of the performance objectives will be measured;
- Monitoring – the intended monitoring program and the process of measuring actual performance;
- Responsibility – responsibility for carrying out each action is assigned to a relevant person/organisation;
- Reporting – the process and responsibility for reporting monitoring results; and
- Corrective action – the action to be implemented in the case of non-compliance and the person/organisation responsible for action.

### **18.3 Project Environmental Assessment**

Environmental impact assessments (EIA) ensure that the environmental impacts of a development proposal are fully considered before it is implemented. An environmental impact assessment determines the type and severity of an activity's environmental impact and is a normal part of the regulatory approval process and good due diligence practice.

Environmental impact assessment capabilities include:

- Flora and vegetation assessment
- Fauna and related habitat assessment
- Site specific characteristics assessment (aspect and relationship to the surrounding area)
- Formulation of environmental management plans
- Liaison with relevant government authorities (Environmental Protection Authority, Department of Parks and Wildlife, Department of Environment Regulation, Commonwealth Department of Environment and Energy, Water Corporation, heritage and the arts, and other local government bodies)
- Advice on other specialist scientific expertise that may be required
- Documentation of the assessment in the format required by regulators which can be used as part of an environmental management plan

### **18.4 Environmental Issues**

#### **18.4.1 Dust**

The company will incorporate dust mitigation strategies, within reason, to minimise the negative impact on the environment, on site personnel and the community. Personnel will continually monitor the site for excessive dust and take appropriate action to minimise exposure and dispersion. Mitigation strategies include:

- Job execution in a manner that reduces dust production
- Provide dust suppression equipment where needed
- Monitor, assess and respond to on-site dust observations
- Ensure vehicles, mobile equipment and significant foot traffic are primarily kept to sealed/stabilised regions

- Awareness of the prevailing wind direction to populated areas and implementation of job schedule accordingly

#### **18.4.2 Noise**

The company will implement measures to reduce noise production beyond unacceptable levels to ensure the environment, personnel and the community are not negatively impacted. The company will always comply with noise regulations of the area in which the site is located. If the site is situated in close proximity to residential dwellings, the company will not conduct noise generating work outside of the specified hours for weekdays and weekends.

When performing work, the company will ensure the environment, on site personnel and the community are not adversely impacted by incorporating the following strategies:

- Hearing PPE for personnel located within areas of elevated noise
- Noise suppression systems on equipment generating significant or ongoing noise
- Speed regulations to limit the noise from vehicles
- Awareness of the prevailing wind direction to populated areas and implementation of job schedule accordingly

#### **18.4.3 Spillages**

The company will be responsible for the prompt response and clean-up of any spillages that occur on the controlled site. On-site personnel will be trained and advised of the location for spill kits, if applicable, and the swift alleviation of a spillage.

All spillages, their contents matter, size and response are to be treated as an on-site incident and are to be reported to the site manager.

#### **18.4.4 Contamination**

The company will actively implement measures to avoid contamination of foreign objects, whether harmful or not, to areas outside of the site boundaries. This will include utilising and performing the following:

- Avoid seepage of materials into groundwater
- Clean vehicles and mobile equipment that cross site boundaries on a regular basis

The company will also ensure contamination of certain materials, particularly chemicals, is localised within sections of the site. This is primarily applicable to the adequate storage of chemicals, which are to meet the requirements outlined on the MSDS. Where applicable, bunding will be in place to ensure the containment of particularly hazardous materials.



#### **18.4.5 Process Waste**

The company will control and correctly dispose of any waste produced during the site operations. Any process waste shall be disposed of in accordance with statutory requirements. If waste materials are not suitable for disposal, the company will utilise treatment processes to ensure safe disposal, or will alternatively send the waste to a licensed facility for subsequent treatment and disposal.

Process waste disposal will meet local Government and other statutory bodies' requirements. In order to minimise process waste, the company will ensure the design and management of a site based landfill facility.

#### **18.4.6 Domestic/Municipal Waste**

The company shall provide sufficient rubbish receptacles and industrial disposal bins for collection of waste and ensure that all such bins are emptied on a regular basis to prevent overfilling. Any hazardous substances shall be disposed of in accordance with statutory requirements at licensed facilities. All rubbish is to be placed in closed containers and no personnel should litter. The Site Supervisor will monitor the cleanliness of the site and take appropriate action if necessary. Personnel must actively seek to minimise rubbish and waste on site.

## **19. OCCUPATIONAL HEALTH, HYGIENE AND SAFETY**

The company is committed to creating and maintaining safe work environments with an aim to have zero workplace health, safety and environmental incidents. The company has clearly outlined the management strategy required to be upheld at all times in order to achieve this goal.

The following document illustrates the Haib Site Safety Management Plan, and is to be considered as the minimum requirements. Haib will strongly advocate that personnel seek to exceed measures outlined in this document, where reasonably practicable, in order to create and maintain safe working conditions.

Haib will continually review health, safety and environmental KPI's and targets in order to re-evaluate and improve the management plan. This plan has been created to be utilised and well understood by all employees and contractors.

## 20. MANAGEMENT PLAN OBJECTIVES

The Haib Site Safety Management Plan aims to complete the following:

- Have zero health, safety and environmental incidents
- Ensure operations are compliant with local and statutory regulations
- Ensure all personnel and contractors are readily able to understand the minimum safety requirements expected
- Develop a system that can be evaluated and improved on
- Ensure absolute transparency regarding health, safety and the environment between all affiliated parties on site
- Maintain the obligation to all stakeholders
- Ensure all operations and outcomes are aligned with the core values

## **21. MANAGEMENT AND SAFETY ACCOUNTABILITY**

### **21.1 Health, Safety and Environment Management**

The following contains a Health, Safety and the Environment (HSE) Management System with documented standards and procedures detailing the company's commitment, responsibilities and methods to achieve leading HSE performance. In the implementation of this HSE Management plan, the following will be executed:

- Specifically address and develop Standards and Procedures that meet company Legislative Requirements
- Make available all relevant Statutory Acts and Regulations, Australian Standards, Codes of Practice and the HSE Management Plan
- Ensure a communication and consultative mechanism is developed and promoted in the implementation the HSE Management Plan

### **21.2 Management Responsibility and Accountability**

The company will:

- Have in place a visible HSE Policy and objectives which have been distributed and communicated to all workers
- Provide information regarding HSE requirements to all workers including subcontractors and visitors
- Monitor, review and communicate the HSE Management System
- Provide adequate, suitably qualified and experienced supervision to act in Supervisor positions
- Audit and monitor the HSE performance
- Identify safety critical roles and ensure these roles are suitably fulfilled
- Consult, communicate and coordinate HSE requirements with all key stakeholders
- Maintain an up to date Organisational Structure

### **21.3 On-site Manager/Supervisor**

Supervisor roles and responsibilities include (but are not limited to) the following:

- Complying with the HSE Management Plan and HSE Management System requirements
- Ensuring risk control measures are implemented in areas and activities for which they are responsible
- Communicating safety information to relevant persons, including between supervisors at the change of shifts.
- Are responsible for ensuring that workplace inspections are carried out in accordance to regulative policy
- Ensuring personnel under their supervision have the appropriate skills, training, competency and knowledge (including access to relevant procedures) to perform their required tasks
- Ensuring all employees associated with their department can attend a toolbox talk each month and the minutes of the meeting distributed appropriately and outcomes communicated to the appropriate people
- Being aware of the Emergency Response and Crisis Management Procedure and act accordingly.
- Giving appropriate feedback to those employees seeking clarification on Health, Safety and Environmental issues
- Investigating and reviewing all accident/incidents within their work area and ensures all information from accidents/incidents is communicated to all personnel within the department and other relevant parties

#### **21.4 Personal Protective Equipment**

The company will ensure that personal protective equipment (PPE) is provided to all personnel and that personnel are trained in the correct use and maintenance of all PPE they are required to use whilst undertaking their assigned duties.

Risk Management principles will be used to determine appropriate PPE for all site activities, whenever PPE requirements are not covered by existing Procedures.

Minimum site requirements:

- High Visibility Long sleeved shirts and/or High Visibility Vests (with reflective stripes at night or in dark periods)
- Long trousers

- Safety footwear
- Safety helmets
- Safety glasses
- Gloves

Additional PPE may be required for particular areas of the site, which may include, but not limited to:

- Hearing protection
- Chemical resistant gloves
- Chemical goggles
- Chemical suits
- Welding gloves, eye protection, apron/clothed protection

All jobs must be accompanied with a risk assessment, which will identify the necessary PPE required to safely complete the job.

### **21.5 Subcontractor Policy**

The company has established and implemented a process for the selection and engagement of subcontractors. This process ensures that information is gathered and an assessment of the contractors HSE Management activities, quality programs and insurances prior to engagement.

Subcontractors shall be audited for HSE compliance during the work as part of planned audits.

Any contractor who is unable to satisfactorily meet the minimum HSE requirements shall be required to follow the HSE Management whilst working on site.

Any contractor who is unable to provide sufficient evidence of a commitment to HSE policies, principles, procedures and/or statutory compliance shall be excluded from the tendering, selection or work process.

### **21.6 General Hazards**

Mining and the subsequent processing of the ore are occupations where workers confront exposure to a broad array of hazards including rock falls, fire, chemical exposure, physical injuries and heat exposure, just to list a few. Identification of hazards (including recognition

of the high potential for personal injury, equipment damage and production interruptions), allocation of control measures to each and assessment of the level of risk is the basis for provision of a workplace which presents as little risk as possible to the project, its staff, contractors, visitors, the local community and the environment. Risk assessments are conducted to help identify the risks and the control measures and to determine areas where further controls may be necessary to reduce the risk to an acceptable level.

A significant component of maintaining a safe workplace and a high standard of safety management is regular and effective communication with the involvement of all personnel. This can help increase awareness of hazards, encourage input and discussion regarding solutions to problems which may be encountered, and generally improve involvement of the workforce in the management of their own safety. Communications about safety can be conducted formally or informally and can include meetings in the workplace among employees, training, regular meetings with supervisors and management, and regular workplace inspections involving members of the workforce. Provision of appropriate tools and equipment (including personal protective equipment) for completing work tasks is also important in the management of workplace hazards.

The general hazards identified include the following:

- Occupational health and hygiene (including injury prevention and rehabilitation, infectious disease management, noise and dust exposure, health surveillance, and fatigue management and fitness for work)
- Vehicle and machinery hazards
- Electrical hazards and isolation systems
- Use and storage of hazardous materials
- Cranes, associated lifting equipment and working at height
- Explosives hazards
- Machine guarding
- Ground control processes, and
- Mine ventilation.

Further to these, general sections are included covering risk management, incident recording and investigation, corrective and preventative actions, and business continuity and emergency response.

This management system is designed to be used as a stand-alone document and it is recommended that its requirements are implemented prior to commencement of operations at the site.

## **21.7 Safety – General**

The following section of this document outlines the general safety and health requirements and issues as they apply throughout the operation – inclusive of both the mine and the plant. It also includes discussion on mitigation measures in each section.

## **21.8 Standard Operating Procedures and Training**

Standard operating procedures are useful, and even vital, for situations where a task must be completed the same way each time for safety or quality control reasons, or where there are risks inherent in the task that may be more effectively controlled by the use of a specific method of completing the task. Some standard operating procedures have already been developed, and more will be developed as the need arises throughout the operational life. These standard operating procedures will be used as the basis for training and competency assessment of mine and plant operators, and maintenance personnel, under the site training programme.

The mining method to be utilised at the operation is the same as that previously used and it is therefore anticipated that many of the employees will already have some skills in equipment operation and production methods applicable to the operation. These employees will still receive some “refresher” training to ensure current competency and compliance with safe operating standards.

Induction training is also required, and will be provided at three levels – visitor, general and area-specific.

- The visitor’s induction will take about 15 minutes to complete and is designed to create awareness among short-term visitors (visits of less than one week) to the site of the types of hazards that they may encounter. Even following completion of the visitors induction visitors will be required to be supervised by a fully inducted person at all times.
- Prior to employees, contractors and visitors being granted unaccompanied access to the surface areas of the site (not including the plant) a general induction must be completed. This induction will be more extensive than the visitor’s induction and will include greater detail about site hazards, and operating and emergency procedures.



Completion of this induction is necessary for all personnel who will be on site for periods greater than one week.

Task observations may also be included as part of a training system. Following initial training and competency assessment, regular task observations can be undertaken to ensure employees remain competent, and where they may have feedback for the improvement of the method for undertaking a task, these modifications can be discussed and recorded. Task observations are based on the requirements outlined in the training and assessment for the task and can include preparation to undertake the task, conduct of the task, and completion.

## **21.9 Occupational Health and Hygiene**

Occupational health is defined by the World Health Organisation (WHO) as the promotion and maintenance of the highest degree of physical, mental and social well-being of workers in all occupations by preventing departures from health, controlling risks, and the adaptation of work to people and people to their jobs. Generally, occupational health requirements are backed up by national legislation.

The specific occupational health measures for discussion include injury prevention and rehabilitation, health surveillance and biological monitoring, infectious disease management, fatigue management, and noise and dust monitoring and control. Ventilation and diesel particulate exposure control are discussed in the Mining section.

### **21.10 Injury Prevention and Rehabilitation**

About 250 million occupational injuries occur throughout the world each year, and around 350,000 workers die each year as a result of these injuries. Occupational injuries and diseases present a major public health issue and place a huge burden on the individual employee and the health system which will help rehabilitate them.

While all care is taken in ensuring that employees, contractors and visitors are not injured in the course of their work or visit to the site, personal injuries may still occur. Following the occurrence of personal injury at the site, a rehabilitation and return-to-work programme will be utilised to ensure employees receive appropriate care for their injury, and can return to a physical state equivalent to that before their incident. The return-to-work programme will include ongoing treatment, and provision of alternative duties for employees who are unable to perform their normal work tasks for a time during their rehabilitation.

The physically demanding work involved in the use of hand-held air-leg equipment may present potential for manual handling issues during the mine operation. The ground support – bolts and mesh – will also be installed by hand using jack-hammers. Each of the drills will

have two operators, each working for a length of time and then exchanging with the other to help reduce the incidence of sprain, strain and vibration-related injuries. Vibration-related injuries are also a consideration for mobile plant operators and these can be reduced through the installation of appropriate seating in the equipment.

### **21.11 Medical Facility**

A medical centre post will be constructed at the processing plant. The facilities will be staffed by a doctor in the employ of the operation. The medical centre will be stocked with emergency equipment and supplies.

### **21.12 Infectious Disease Management**

Malaria, plague, and African trypanosomiasis (sleeping sickness) pose high risk in some areas. Human immunodeficiency virus (HIV) infection is also prevalent with approximately 4.5% of the adult population infected and, consequently, about 100,000 deaths annually. Due to the huge impact of infectious disease, the life expectancy at birth is approximately 51 years (2006 estimate). Approximately 46% of the total population has access to improved drinking water services and only 29% (approx.) have access to adequate sanitation facilities.

Malaria infection makes a huge impact on an employee's ability to attend work every day. A study released by BHP-Billiton showed that 1 in 3 employees fell ill with malaria which translated into 6,600 cases in 2 years. Thirteen employees died from complications related to their malaria infection and all this despite the provision of a site medical centre, local spraying to kill the mosquitoes and provision of bed nets to employees. The operation believed it was unable to support absenteeism on this scale and so joined forces with local authorities to implement a region-wide malaria control program. Consideration for involvement in a similar program is recommended to help infectious disease management by the operation and also as an external relations project for the benefit of the wider community.

### **21.13 Health Surveillance and Biological Monitoring**

Health surveillance is generally the responsibility of the employer and the type and regularity of surveillance should be determined by risk assessment. All potential workplace exposures need to be determined and assessed to show the level of risk posed to employees working in different locations, performing different tasks. Employee health surveillance is conducted in conjunction with the monitoring of the work environment. Biological monitoring forms part of the health surveillance regime by accounting for personal exposure to chemical

substances through blood and urine sampling. The need for biological monitoring for specific employees or tasks, and the regularity of the monitoring, is determined by risk assessment.

A base-line of employee health (prior to commencement of work) can be established through conduct of pre-employment medical examinations which include questionnaires, diagnostic and biological tests, and function measurements. Subsequent regular health evaluations can then be compared with this initial base-line by undertaking the same tests to determine whether there is a change in the health of the employee. Consideration should be given in the questionnaire to determining what events and injuries may have occurred outside the workplace that may contribute to changes in each of the health assessment areas.

Results of all health surveillance tests and monitoring, and other environmental monitoring, will be recorded and assessed to determine whether further exposure control measures are required, and in which locations. Personnel will receive confidential notification of any changes that have been determined through their personal health surveillance and biological monitoring. They will also receive treatment or other measures which may be required as a result of their exposure.

#### **21.14 Noise Exposure**

Exposure to noise is a generic hazard in most areas of the mine and mineral processing work environment. Generally the mining task which produces the greatest noise level is the operation of drilling equipment. High levels of noise are also generated by ventilation fans and diesel powered equipment. High levels of noise exposure may also be experienced in the surface operations in workshops and when using noisy equipment in confined spaces.

Noise exposure is expressed as a function of exposure level and duration. According to the National Institute for Occupational Safety and Health (NIOSH) in the United States, the recommended exposure limit (REL) is a time weighted average (TWA) of 85 decibels (A-weighted) – 85 dB(A). Exposures above this level are considered hazardous and exposure to continuous, varying, intermittent, or impulsive noise should never exceed 140 dB(A) under any circumstances for even a short period of time. Monitoring of noise levels in static locations throughout the operation is recommended, as is personal noise monitoring in the hearing zone of the employee over the duration of a shift.

Hearing protection will be included as part of the basic personal protective equipment provisions, and wearing it will be mandatory where work is undertaken in the vicinity of loud equipment items. The most effective method for reduction of noise exposure is the purchase of low noise producing equipment, and where this is not possible, separation of the equipment from personnel through the use of enclosures. Training will be provided to all

employees in relation to the correct use and operation of hearing protection devices, and the types of hearing protection devices necessary in each location. Signage will also be provided in locations throughout the site where hearing protection is required.

### **21.15 Dust Exposure**

The production of dust in hard-rock mining is an inevitable part of the process, although, when less dust is generated, less effort needs to be expended on suppression. The crushing of the ore and the fall of ore from one conveyor to another or onto the ore stockpile as well as unsealed roadways are other situations where significant dust levels may be encountered.

Respirators and dust masks, appropriate for the dust type and particle size, will be provided to employees for use in locations where methods of dust suppression or control are unable to be used, or are deemed inadequate. Training will be provided for use of the correct respirator or mask for each situation, and the correct method for their use. It may also be a requirement for employees to remain clean-shaven to ensure an appropriate respirator seal when required.

Throughout the surface operations, roadway and open-area watering using a water truck is recommended to reduce dust. Dust collectors are also included in the plant design to reduce personal exposure to dust from the stockpile feeders and lime bin. Where it is determined that dust may be generated over large areas with no vegetation, dust control barriers can be installed to reduce dust movement.

Regular monitoring of dust generation and exposure is also recommended. This should include fixed dust collection/sampling locations throughout the site to determine the composition and quantity of background dust and personal monitoring through measurement of dust composition and exposure levels in the breathing zone of persons over the period of a work shift.

### **21.16 Fatigue Management**

Fatigue is defined as tiredness arising from mental or physical exertion, or insufficient sleep. Shift work is a common cause of disruption to sleeping patterns, with night shift causing the most difficulty (it is often difficult to get adequate sleep during the day). Fatigue can increase the risk of human error and therefore increase the potential for incidents to occur as a result of the errors. Working overtime hours/shifts can also contribute to fatigue in the workplace.

Fatigue can be managed through regular work schedules, control of humidity, noise and vibration levels in the workplace, adequate rest and a balanced diet. The risk of error

through fatigue can also be increased by repetitive and very physical work which these can be managed through job rotation and regular breaks. As mentioned above, employees required to operate the manual drilling and jack-hammering equipment will rotate regularly to reduce fatigue.

### **21.17 Fitness for Work**

Fatigue, caused by sleep deprivation, excessive working hours, consumption of alcohol or other drugs, or other situations are all circumstances which may cause an employee to be unfit to carry out their work duties in a safe manner. It is the responsibility of the employee to present at work in a fit state to complete their work. Where an employee is unfit for work they must notify their supervisor of the situation, including the reason, prior to the commencement of their shift. If employees are taking prescribed medication which may impair their ability to conduct their work safely, without risk to others, the supervisor must also be notified.

### **21.18 Vehicles and Machinery**

Incidents involving mobile equipment and machinery are one of the highest causes of fatalities, and accidents causing permanent disability, in the mining industry. One factor that contributes significantly to these incidents is the operational blind spots experienced by the operators of both small and large machinery and equipment. These blind spots can present significant risk even on the surface where visibility is increased because of the light.

Incidents involving human-mobile plant interaction can be greatly reduced through the installation of proximity warning equipment and cameras to give the operator vision in some of the blind spot areas. Procedures should also be developed which can include exclusion zones surrounding mobile plants, design of the process to reduce the need for reversing, routing traffic away from pedestrian areas, communication with equipment operators when in proximity to the equipment and appropriate isolation of equipment when undergoing maintenance. As an example, the operator of a load-haul-dump (LHD) machine has particularly poor vision from the cab due to the size of the bucket (often exceeding the height of a human), the position of the operator (seated in a sideways position relative to the travel of the machine), and restricted visibility from the cabin (due to the equipment design). These factors, and others including adjustable seating, should be considered when purchasing the equipment. Another avenue for reduction of risk associated with visibility from the machinery is to ensure lights, front and rear, remain clean to allow as much light to emit as possible.

Incidents and injuries involving the operation of forklifts are also very common. These can result from restricted operator visibility when carrying a load, interruptions to the operator's

concentration, and lack of operator competency. These incidents can be reduced through open and unobstructed design of the areas where fork-lifts will operate on a regular basis (particularly for unloading and loading in the store), training and competency assessment of operators, procedures relating to exclusion zones around operating equipment, and requirements for communication with the operator when in proximity.

### **21.19 Hazardous Materials**

The use of hazardous materials is inherent in the operation of a mine and processing plant. At the Haib Copper Project a significant proportion of the chemical and hazardous materials use will occur in the plant (see detailed discussion relating to hazardous materials used in the plant), but the mining operation will use large quantities of sulfuric acid, lime and diesel (for the operation of plant and equipment). Machinery maintenance personnel will also use hydraulic oil, lubricants and other machinery fluids, acids (for batteries), and cleaning compounds. Material safety data sheets (MSDS) will be provided to ensure appropriate chemical information is available in each location where chemicals are used. Standard operating procedures and associated training will also include information about hazardous materials and safe handling requirements as they pertain to each task.

Explosives are also classified as hazardous materials.

### **21.20 Electrical Safety**

Personal contact with electricity can result in electrocution, electric shock (and its effects), explosions and fires. This contact can occur in a variety of ways including vehicles or equipment contact with the power supply cabling, water ingress into power supply components, inadequate isolation during maintenance, short circuits and earthing faults. Electrical cabling and power boxes are required throughout the entire site for the operation of all electrical equipment. All electric shocks are serious and should be reported and investigated (in accordance with the incident and accident reporting process. The employee who received the shock should be monitored closely by medical personnel immediately following the incident.

All electrical cabling and electrical connections are to be installed by appropriately qualified electricians. All equipment will be regularly tested and maintained in accordance with local regulations and standards. Standard operating procedures will include information about electrical installations and associated hazards, in proximity to where other work is undertaken, and appropriate isolation of electrical equipment. Earth leakage protection installation and testing will be undertaken in accordance with local regulations and

standards. Electrical cabling will be installed with a mechanical protection layer (included in the manufacture) to help reduce the hazards associated with mechanical impacts. Electrical equipment must only be used for its intended purpose and not abused. Residual current devices should also be installed for extra protection when using hand-held electrical tools and extension leads. These devices require regular testing to ensure they are effective.

All testing and maintenance will be recorded (as required by local regulations) and failures of equipment or procedures will be recorded and investigated through the incident/accident investigation process.

### **21.21 Energy Isolation**

Energy isolation is usually associated with isolation of electrical systems, but it also includes isolation of flow and pressure to a location, procedures and equipment to prevent sudden movement of equipment e.g. a truck falling off a jack or sudden articulation of machinery, and ventilation of tyres held inside a frame to prevent explosion. The isolation process generally uses tagging and specific procedures designed to protect employees working on equipment and inform others about the operational state of the equipment, plant or system. The isolation system is to be applied throughout the site including the mine, the processing plant, all workshop areas and where work is carried out in the administration buildings.

At the Haib Copper Project international standard isolation systems and procedures will be utilised to help mitigate associated hazards. This system will include two main tags, with other tags to be added as required.

The most commonly used tag will be the 'Out of Service' tag which is placed on any item of equipment which is non-operational, for any reason (e.g. the switch on an electrical item is faulty and requires repair, or the engine has been removed from a truck for repairs in the workshop). This tag is designed to convey information relating to the useability of the item, and should only be removed by the person completing the repairs after the repairs are complete.

The other main tag is the 'Personal Danger' tag which is designed to protect an employee involved in repair or maintenance in the vicinity. Systems will be disabled, blocked and locked in the 'off' position and this tag attached to a lock at the isolated point to convey information about the person completing the work. The tag and locking system (together) is designed to protect the employee from harm by preventing the operation of the equipment or system on which they are working. Employees will receive training based on isolation information included in standard operating procedures to ensure competency in the use of these systems.

## **21.22 Cranes, Lifting Equipment and Working at Height**

Any task where there is the potential for a person or other item/s to fall can be considered as highly dangerous. Extensive control measures are put in place to help ensure incidents do not occur, equipment is not damaged and personnel are not injured.

## **21.23 Cranes and Lifting Equipment**

Gantry cranes are used throughout the workshops and the plant for small lifts. These are suspended from an overhead frame in the building structure (often providing a track for the crane to move along) and are operated using hand-held controls. Other crane equipment (especially mobile cranes) may also be used throughout the site when large or heavy items require moving or lifting. All crane equipment requires ongoing inspection and maintenance, in accordance with manufacturers' instructions and standard maintenance programs, to ensure it remains operational and safe. Personnel required to operate this type of equipment should receive initial training and competency assessment, and regular refresher training to help ensure the equipment is operated safely and within its limits.

It is recommended that chains, hooks, ropes and slings for lifting should be inspected by operators prior to each use (and their condition recorded), and inspected and tested by authorised personnel regularly (e.g. every three months) to ensure they remain in good condition and are capable of performing to their rated capacity. All personnel required to inspect and use items of lifting equipment will receive training and competency assessment which will include recognition of equipment faults. A tagging system may also be used, following authorised testing, to provide information to users about the condition of the lifting equipment.

## **21.24 Work at Height**

Work at height is defined as work undertaken in any area, including at or below ground level, or entering/exiting from such an area (except by a staircase) where a person could fall a distance liable to cause personal injury. Generally, working at high levels in a plant, for example, does not constitute work at height due to the area being accessible by stairs and fitted with handrail. The platform constitutes a normal work space. However, work conducted in proximity to the edge of the platform, where there is the potential of falling over the edge is classified as work at height. Incidents involving fall from height constituted approximately 30% of fatal injuries in all industries across the United Kingdom between 1997 and 2001, and also a significant proportion (approximately 9%) of non-fatal injuries.

Reduction of the risk of fall from height incidents can include the following measures:



- Elimination of the need to work at height (at the design stage of the project),
- Construction of permanent structures in locations where work at height is required on a regular basis,
- Plan for, and install, appropriate attachment devices for use by workers when required at a later point in the operation,
- Training and competency assessment for the use and maintenance of fall protection equipment,
- Risk assessments and other hazard identification sessions to identify locations where there is a risk of fall from height, and
- Provision of harnesses, fall arrest and restraint devices, ropes and other attachments.

### **21.25 Personal Protective Equipment**

Personal protective equipment is the least effective form of protection against workplace hazards. It is designed to help protect employees against hazards that were not able to be eliminated by other means. Personal protective equipment will be provided to all employees (at no cost to them) for use in the course of their work. This will include a minimum of safety boots, hard-hats (helmets), glasses (medium to high impact protection) and long sleeve/long trousers clothing.

Further items of personal protective equipment will be provided for use during specific tasks, as determined by risk assessment and as recommended by product manufacturers (particularly for chemical products). Items of specific personal protective equipment will be located in proximity to the areas where the equipment is required to be used. Training will be provided for all employees regarding the appropriate fitting and care of provided items of personal protective equipment. Personal protective equipment information will also be included in standard operating procedures. Personal protective equipment will be provided to employees at no cost. The wearing of provided minimum personal protective will be mandatory for all employees and disciplinary action will be taken where employees do not comply with requirements.

### **21.26 Inspections and House-Keeping**

Workplace inspections can provide a thorough, critical examination of a work area, record hazards for corrective action, and provide a follow-up opportunity to determine whether recommended actions have been implemented. Workplace inspections are designed to be

conducted on a regular basis. The frequency of inspections should occur in accordance with the types and levels of risks in the location. Inspections can occur as a quick check and occur with high frequency (e.g. once per shift), or a detailed 'audit' of an area with lower frequency (e.g. six monthly to annually).

The less frequent, more detailed, inspections should cover legal aspects, physical, behavioural and system controls as well as housekeeping. The inclusion of these sections in the inspection, and the requirement for a variety of personnel to participate, can highlight a variety of areas for improvement by requiring the assessment to be undertaken systematically. They also provide focal points for the inspectors, although care needs to be taken to ensure other aspects are not over-looked. For the less frequent inspections, a roster can be established to ensure that these are allocated and marked off as they occur throughout the assigned time period.

The changes in the work area from one rostered shift to the next can be significant, and employees should complete these inspections to ensure they are aware of any hazards particular to their work area where the site has changed since their last shift.

Effective house-keeping can help eliminate workplace hazards through the removal of trip hazards, maintaining a tidy workplace and ensuring equipment is put away after use. House-keeping is ongoing and the state of a workplace can often be a good indicator of the safety culture within the workplace. Appropriate house-keeping in the workplace can also include repair of damaged or broken items (like shelving), removing nails, wire etc., which protrude, and appropriate storage of items which are hazardous or used infrequently. Rubbish removal, an integral part of house-keeping, also reduces the potential for fires to occur in the workplace and not allow items to impede egress in the case of an emergency.

## **22. SOCIAL AND COMMUNITY MANAGEMENT**

The company shall ensure the following aspects are considered to minimise the impact of its operations on the local community.

### **22.1 Community and Stakeholder Relations**

The following actions shall be taken to ensure the community and all stakeholders are considered throughout the site operations. The local community concerns include:

- Community consultation as and when required
- Safe driving and road courtesy by all
- Respect for the community and natural environment
- Consideration of local people
- Establishing a mechanism for the reporting of public complaints

### **22.2 Local Environment Consideration**

The following shall be clearly communicated to site personnel and appropriate controls are implemented accordingly:

- Dispose of your own rubbish
- Respect and care for native bush, no driving of off-road vehicles except in designated tracks and areas
- Native vegetation is not cleared or damaged without consent
- A permit to clear vegetation must be submitted and approved prior to clearance
- No ground disturbance without consent
- Native fauna is not injured due to poor work practices
- Our workers are aware of potential impact on native fauna
- No deliberate harm inflicted on all native fauna
- Local fire regulations are adhered to, the district is subject to extreme risk of bushfires
- Obtain a hot work permit before conducting hot work
- Participate in fire fighting training

- Provide and maintain fire fighting equipment

## 23. CAPITAL COST

### 23.1 Scope and Methodology

The CAPEX estimation was for processing only which excludes the capital costs associated with mining. METS estimated capital costs for crushing, screening, grinding, heap loading, leaching, solvent extraction and refining. Workshops and offices are covered under the plant infrastructure which mining will use. At this stage it was assumed that the mining would be executed via contract mining and all associated capital was to be included in the mining operating expense. It is anticipated that mining capital cost will be covered at the Feasibility Study stage where more work will be done for mining. The estimates were made for a plant with different plant capacities and were made for individual options including:

- Option 1: 8.5 Mtpa with 80% copper recovery with  $\text{CuSO}_4$  (base case)
- Option 2: 8.5 Mtpa with 85% copper recovery
- Option 3: 8.5 Mtpa with 85% copper recovery with  $\text{CuSO}_4$
- Option 4: 20 Mtpa with 80% copper recovery with  $\text{CuSO}_4$
- Option 5: 20 Mtpa with 85% copper recovery
- Option 6: 20 Mtpa with 85% copper recovery with  $\text{CuSO}_4$

### 23.2 Basis of the Estimate

The scoping level study capital cost estimates are based on historical equipment pricing and then factoring the materials and installation costs along with using the appropriate scaling factors. Vendors were contacted for major equipment such as crushers, HPGRs and ore sorters to obtain budgetary estimates. These quotes were scaled for options which had different throughput rates to the quoted amount.

#### 23.2.1 Direct Costs

All direct equipment and infrastructure costs will be assumed to be new for this estimate and no second hand purchases are included. The cost of this equipment was estimated based on historical cost data collected by METS engineering and the installation costs factored to include costs for the following:

##### Earthworks

- Clearing of the site of vegetation
- Grubbing of roots and other materials from the site

- Bulk Earthworks
- Initial grading of the site for construction
- Major excavation (by machine) for concrete foundations
- Major backfilling (by machine) for concrete foundations
- Final grading and drainage contouring of the site
- Paving

### **Concrete**

- Final trimming of the excavations
- Supplying and setting of formwork and shoring
- Supplying and installing reinforcing steel
- Supplying and installing embedded items
- Supplying and placing mixed concrete
- Finishing of the concrete
- Curing of the concrete
- Stripping of the formwork and shoring
- Final patching and finish
- Protective coatings for concrete surfaces
- Supplying and installing pre-cast concrete
- Supplying and installing concrete masonry

### **Structural Steel**

- Detailing of structural steel from engineers drawings
- Supply and fabrication of steel materials and their fastenings
- Dismantling and salvage of steel materials
- Sandblasting and painting as required
- Transporting steel to site
- Unloading and “shaking-out” of steel in laydown areas
- Transporting steel to erection areas

- Checking the concrete dimensions before erection
- Erecting structural steel
- Plumbing and alignment of erected steel structures
- Tightening of all bolts according to specification
- Installation of metal roof and wall sheeting
- Installation of all ventilators and louvers
- Installation of doors and windows including frames
- Installation of flashing, edge strips, and sealers
- Installation of gutters and downspouts

### **Equipment**

- Furnishing of the equipment by vendors
- Dismantling and salvaging equipment
- Transporting the equipment to site
- Unloading and storing on site
- Installing the equipment
- Mechanical testing of the equipment prior to start-up
- Sole plates, anchor bolts, safety guards, and all other items necessary to make the equipment operable

### **Piping**

- Furnishing all pipe, valves and fittings
- Fabricating all pipe in a shop or on site
- Installing all pipe, valves and fittings
- Installing pipeline bodies for instruments
- Installing instrument airlines to final block valve
- Cleaning of the pipelines as specified
- Testing the pipelines as specified

## Electrical and Instrumentation

- Installing all electrical equipment
- Installing all pull boxes, junction boxes etc.
- Installing all electrical cable and wire
- Furnishing all electrical equipment and bulk materials
- Dismantling and salvaging electrical equipment
- Installing all cable tray and conduit
- Furnishing and installing all hangers and supports
- Connecting all terminations
- Testing of all circuits and high voltage splices
- Furnishing all instruments at site
- Bench testing and calibration of all instruments as required prior to installation
- Furnishing and installing all supports and hangers
- Installing all pipe in-line instruments in pipeline bodies
- Installing all instrument airlines from block valve to instrument
- Installing all wiring between controllers, instruments, instrument blocks, power sources, and sending units
- Testing of all instruments, interlocks etc. after installation

### 23.2.1.1 Power Supply Cost

A total of US\$1,000,000 has been included for the supply of power including power transmission lines and transformers (underground and overhead). This cost also covers the cost for a small emergency diesel power generator to account for emergency events to supply power for critical equipment such as emergency lighting. Additional costs for installation have also been considered in the CAPEX estimation calculating as a percentage of the equipment cost.

NamPower may provide the substation and transmission line and include in the power supply tariff. Future studies would include discussions with NamPower in order to clarify this.

Future Studies would also consider solar and wind power for the site.

The breakdown of the power supply cost can be viewed in Table 23-1.



**Table 23-1: Power Supply Capital Cost**

<b>Power Supply Items</b>	<b>Cost, USD</b>
Power transmission lines and transformers etc.	700,000
Emergency diesel power generator (100 kVA)	300,000
Installation costs	420,000
<b>Total</b>	<b>1,420,000</b>

### 23.2.1.2 Water Supply Cost

Water supply capital cost for the mine site and process site is estimated based on the inclusion of two raw water dams with a pump station and 15 km pipeline from the Orange River, water pumps and process water tanks. The breakdown of the water supply capital costs for different options can be seen in Table 23-2.

**Table 23-2: Water supply capital cost**

<b>Water Supply Items</b>	<b>Option 1 USD</b>	<b>Option 2 USD</b>	<b>Option 3 USD</b>	<b>Option 4 USD</b>	<b>Option 5 USD</b>	<b>Option 6 USD</b>
Mine site water dam including pipelines	260,000	260,000	260,000	260,000	260,000	260,000
Process site water dam including pipelines	525,000	515,000	525,000	1,133,000	1,124,200	1,133,000
Water pumps	118,000	118,000	118,000	156,000	156,000	156,000
Process water tanks	615,000	609,000	615,000	808,000	803,000	808,000
Installation costs	1,138,500	1,126,500	1,138,500	1,767,750	1,757,250	1,767,750
<b>Total</b>	<b>2,656,500</b>	<b>2,628,500</b>	<b>2,656,500</b>	<b>4,124,750</b>	<b>4,100,250</b>	<b>4,124,750</b>

### 23.2.2 Indirect Costs

As the costing is a Class 5 estimate, all indirect costs were calculated by factoring from the direct costs. The indirect costs include:

#### Engineering and Procurement

- Revising the Mission engineering drawings to accommodate the revised elevations and coordinates.
- Performing engineering on new equipment and associated equipment
- Planning, prioritising and coordinating the engineering work
- Review or various trade off studies to minimize installation costs
- Review and finalisation of the design criteria
- Review and finalisation of the process flow sheet drawings
- Development of all process calculations
- Preparation of the Water Balance

- Preparation of the Material Balance
- Final sizing of all new equipment
- Development of the Equipment List
- Preparation of the Piping and Instrument Diagrams (P&IDs)
- Review of existing drawings
- Site visits as required
- Meetings as required
- Checking and collecting on-site dimensions
- Coordinate and evaluate geotechnical studies and reports
- Surveying
- Preparation of the General Arrangement Drawings
- Preparation of Detail Engineering drawings
- Preparation of all Civil and Site drawings
- Preparation of Electrical cable and conduit drawings
- Preparation of all Instrumentation layout drawings
- All other drawings required to provide a complete engineering design
- Preparation of specifications for new equipment
- Preparation of Requests for Quotation (RFQs)
- Preparation of contractor bid documents
- Evaluation of all bids
- Recommendations for all bids
- Preparation of the contract or purchase order documents
- Processing all change orders to contracts and purchase orders
- Preparation of the project schedule
- Preparation of the operating cost estimate
- Preparation of the capital cost estimate
- Provision of technical assistance during construction

- Provision of changes to the design during construction
- Management and administration of the engineering work
- Travel, communications, living cost, supplies, computers and all other costs necessary to engineer and procure for the project

### **Construction Management**

- Coordination of the overall safety program
- Coordination of the construction work around the operation schedule
- Planning, coordination, and organization of the construction work with the contractors
- Construction surveying and survey control
- Inspection of the quality and progress of the work
- Surveying the work for correctness and quantities installed
- Approval/disapproval of all progress reports submitted for payment
- Identify potential problem areas and recommend solutions
- Review and approve/disapprove of change order requests
- Provision of quality testing, control and assurance of the work
- Provision of coordination and progress meetings with contractors and vendors
- Provision of all engineering documents to contractors
- Coordination of all engineering changes
- Provision of technical assistance as required
- Maintaining records of actual on-site installation
- Preparation of the As-built drawings
- Administration of the construction contracts
- Controlling and reporting of the project cost and schedule
- Approving and processing of all invoices
- Expediting, inspection and receipt of all deliveries

## Field Office

- Provision of offices for contractor administration
- Provision of warehouse areas
- Provision of outdoor storage areas
- Provision of all utilities and infrastructure (roads, electrical, water, sewage, telephone, etc.) associated with the above
- Provision for control of the contractors ingress and egress

23.3 Capital Cost – Option 1 (Base Case)

DEEP SOUTH Resources Inc.		METS ENGINEERING PROCESS + INNOVATION		<b>Haib Copper Project</b>									
				<b>8.5 Mtpa @ 80% Copper Recovery + CuSO4</b>									
				Date 20/04/2020		Project Number J5329		CAPITAL COST ESTIMATE					
<b>Whole Ore Heap Leach</b>													
AREA		Equipment	Earthworks	Concrete	Structural Steelwork	Mechanical Installation	Pipework	Electrical and Instrumentation	Roads, etc	Freight	Total per Item		
			5 %	2 %	10 %	35 %	5 %	7 %	2 %	9 %	75 %		
		USD	USD	USD	USD	USD	USD	USD	USD	USD	USD		
1	100	Crushing	\$ 16,910,000	\$ 845,500	\$ 338,200	\$ 1,691,000	\$ 5,918,500	\$ 845,500	\$ 1,183,700	\$ 338,200	\$ 1,521,900	\$	29,004,500
2	200	HPGR	\$ 12,991,000	\$ 649,550	\$ 259,820	\$ 1,299,100	\$ 4,546,850	\$ 649,550	\$ 909,370	\$ 259,820	\$ 1,169,190	\$	22,234,250
3	300	Agglomeration and Heap Leaching	\$ 13,316,000	\$ 665,800	\$ 266,320	\$ 1,331,600	\$ 4,660,600	\$ 665,800	\$ 932,120	\$ 266,320	\$ 1,198,440	\$	22,803,000
4	400	Copper Solvent Extraction	\$ 23,724,000	\$ 1,186,200	\$ 474,480	\$ 2,372,400	\$ 8,303,400	\$ 1,186,200	\$ 1,660,680	\$ 474,480	\$ 2,135,160	\$	41,197,000
5	500	Iron Removal and Tailings	\$ 2,812,000	\$ 140,600	\$ 56,240	\$ 281,200	\$ 984,200	\$ 140,600	\$ 196,840	\$ 56,240	\$ 253,080	\$	4,921,000
6	600	Process and Raw Water	\$ 1,518,000	\$ 75,900	\$ 30,360	\$ 151,800	\$ 531,300	\$ 75,900	\$ 106,260	\$ 30,360	\$ 136,620	\$	2,656,500
7	700	Reagents	\$ 2,590,200	\$ 129,510	\$ 51,804	\$ 259,020	\$ 906,570	\$ 129,510	\$ 181,314	\$ 51,804	\$ 233,118	\$	4,532,850
8	800	Services	\$ 1,633,000	\$ 81,650	\$ 32,660	\$ 163,300	\$ 571,550	\$ 81,650	\$ 114,310	\$ 32,660	\$ 146,970	\$	2,857,750
9		First Fill	\$ 7,600,000								\$ 684,000	\$	8,284,000
Infrastructure													
10		Misc	\$ 328,000	\$ 16,400	\$ 6,560	\$ 32,800						\$	383,760
11		Mobile Equipment	\$ 795,000									\$	795,000
12		Laboratory	\$ 136,000	\$ 6,800	\$ 2,720	\$ 13,600						\$	159,120
13		Power Supply (overhead and underground)	\$ 1,000,000	\$ 50,000	\$ 20,000		\$ 350,000					\$	1,420,000
14		System Communications	\$ 40,000									\$	40,000
15		Workshop and Store	\$ 160,000	\$ 8,000	\$ 3,200	\$ 16,000					\$ 14,400	\$	201,600
<b>Direct Cost Total</b>			<b>\$ 85,553,200</b>	<b>\$ 3,855,910</b>	<b>\$ 1,542,364</b>	<b>\$ 7,611,820</b>	<b>\$ 26,772,970</b>	<b>\$ 3,774,710</b>	<b>\$ 5,284,594</b>	<b>\$ 1,509,884</b>	<b>\$ 7,492,878</b>	<b>\$</b>	<b>141,490,330</b>
Indirect Costs													
1		Working Capital	10%				10% of Direct Costs					\$	14,149,033.00
2		Insurance	3%				3% of Equipment Cost					\$	4,244,709.90
3		EPCM	10%				10% of Direct Costs					\$	14,149,033.00
4		Contingency	10%				10% of Direct Costs					\$	14,149,033.00
5		Commissioning	2%				2% of Direct Costs					\$	2,829,806.60
6		Workforce accomm & meals, temp services	2%				2% of Direct Costs					\$	2,829,806.60
7		Spares and tools	2%				2% of Equipment Cost					\$	1,711,064.00
<b>Indirect Cost Total</b>												<b>\$</b>	<b>54,062,486</b>
<b>TOTAL COST</b>												<b>USD</b>	<b>\$ 195,552,816</b>

23.4 Capital Cost – Option 2

DEEP SOUTH Resources Inc.		METS ENGINEERING PROCESS + INNOVATION		<b>Haib Copper Project</b>							
				<b>8.5 Mtpa @ 85% Copper Recovery</b>							
				Date 13/03/2020	Project Number J5329			CAPITAL COST ESTIMATE			
<b>Whole Ore Heap Leach</b>											
AREA	Equipment	Earthworks	Concrete	Structural Steelwork	Mechanical Installation	Pipework	Electrical and Instrumentation	Roads, etc	Freight	Total per Item 75 % USD	
		5 %	2 %	10 %	35 %	5 %	7 %	2 %	9 %		
<b>Direct Costs</b>		USD	USD	USD	USD	USD	USD	USD	USD	USD	USD
1	100 Crushing	\$ 16,910,000	\$ 845,500	\$ 338,200	\$ 1,691,000	\$ 5,918,500	\$ 845,500	\$ 1,183,700	\$ 338,200	\$ 1,521,900	\$ 29,004,500
2	200 HPGR	\$ 12,991,000	\$ 649,550	\$ 259,820	\$ 1,299,100	\$ 4,546,850	\$ 649,550	\$ 909,370	\$ 259,820	\$ 1,169,190	\$ 22,234,250
3	300 Agglomeration and Heap Leaching	\$ 13,316,000	\$ 665,800	\$ 266,320	\$ 1,331,600	\$ 4,660,600	\$ 665,800	\$ 932,120	\$ 266,320	\$ 1,198,440	\$ 22,803,000
4	400 Copper Solvent Extraction	\$ 25,020,000	\$ 1,251,000	\$ 500,400	\$ 2,502,000	\$ 8,757,000	\$ 1,251,000	\$ 1,751,400	\$ 500,400	\$ 2,251,800	\$ 43,465,000
5	500 Iron Removal and Tailings	\$ 2,812,000	\$ 140,600	\$ 56,240	\$ 281,200	\$ 984,200	\$ 140,600	\$ 196,840	\$ 56,240	\$ 253,080	\$ 4,921,000
6	600 Process and Raw Water	\$ 1,502,000	\$ 75,100	\$ 30,040	\$ 150,200	\$ 525,700	\$ 75,100	\$ 105,140	\$ 30,040	\$ 135,180	\$ 2,628,500
7	700 Reagents	\$ 2,398,200	\$ 119,910	\$ 47,964	\$ 239,820	\$ 839,370	\$ 119,910	\$ 167,874	\$ 47,964	\$ 215,838	\$ 4,196,850
8	800 Services	\$ 1,633,000	\$ 81,650	\$ 32,660	\$ 163,300	\$ 571,550	\$ 81,650	\$ 114,310	\$ 32,660	\$ 146,970	\$ 2,857,750
9	First Fill	\$ 7,600,000								\$ 684,000	\$ 8,284,000
<b>Infrastructure</b>											
10	Misc	\$ 328,000	\$ 16,400	\$ 6,560	\$ 32,800						\$ 383,760
11	Mobile Equipment	\$ 795,000									\$ 795,000
12	Laboratory	\$ 136,000	\$ 6,800	\$ 2,720	\$ 13,600						\$ 159,120
13	Power Supply (overhead and underground)	\$ 1,000,000	\$ 50,000	\$ 20,000		\$ 350,000					\$ 1,420,000
14	System Communications	\$ 40,000									\$ 40,000
15	Workshop and Store	\$ 160,000	\$ 8,000	\$ 3,200	\$ 16,000					\$ 14,400	\$ 201,600
<b>Direct Cost Total</b>		<b>\$ 86,641,200</b>	<b>\$ 3,910,310</b>	<b>\$ 1,564,124</b>	<b>\$ 7,720,620</b>	<b>\$ 27,153,770</b>	<b>\$ 3,829,110</b>	<b>\$ 5,360,754</b>	<b>\$ 1,531,644</b>	<b>\$ 7,590,798</b>	<b>\$ 143,394,330</b>
<b>Indirect Costs</b>											
1	Working Capital	10%				10% of Direct Costs					\$ 14,339,433.00
2	Insurance	3%				3% of Equipment Cost					\$ 4,301,829.90
3	EPCM	10%				10% of Direct Costs					\$ 14,339,433.00
4	Contingency	10%				10% of Direct Costs					\$ 14,339,433.00
5	Commissioning	2%				2% of Direct Costs					\$ 2,867,886.60
6	Workforce accomm & meals, temp services	2%				2% of Direct Costs					\$ 2,867,886.60
7	Spares and tools	2%				2% of Equipment Cost					\$ 1,732,824.00
<b>Indirect Cost Total</b>											<b>\$ 54,788,726</b>
<b>TOTAL COST</b>										<b>USD</b>	<b>\$ 198,183,056</b>

23.5 Capital Cost – Option 3

				Haib Copper Project							
				8.5 Mtpa @ 85% Copper Recovery + CuSO4							
		Date 13/03/2020	Project Number J5329	CAPITAL COST ESTIMATE							
<b>Whole Ore Heap Leach</b>											
AREA	Equipment	Earthworks	Concrete	Structural Steelwork	Mechanical Installation	Pipework	Electrical and Instrumentation	Roads, etc	Freight	Total per Item 75 % USD	
		5 %	2 %	10 %	35 %	5 %	7 %	2 %	9 %		
Direct Costs		USD	USD	USD	USD	USD	USD	USD	USD	USD	
1	100 Crushing	\$ 16,910,000	\$ 845,500	\$ 338,200	\$ 1,691,000	\$ 5,918,500	\$ 845,500	\$ 1,183,700	\$ 338,200	\$ 1,521,900	\$ 29,004,500
2	200 HPGR	\$ 12,991,000	\$ 649,550	\$ 259,820	\$ 1,299,100	\$ 4,546,850	\$ 649,550	\$ 909,370	\$ 259,820	\$ 1,169,190	\$ 22,234,250
3	300 Agglomeration and Heap Leaching	\$ 13,316,000	\$ 665,800	\$ 266,320	\$ 1,331,600	\$ 4,660,600	\$ 665,800	\$ 932,120	\$ 266,320	\$ 1,198,440	\$ 22,803,000
4	400 Copper Solvent Extraction	\$ 24,187,000	\$ 1,209,350	\$ 483,740	\$ 2,418,700	\$ 8,465,450	\$ 1,209,350	\$ 1,693,090	\$ 483,740	\$ 2,176,830	\$ 42,007,250
5	500 Iron Removal and Tailings	\$ 2,812,000	\$ 140,600	\$ 56,240	\$ 281,200	\$ 984,200	\$ 140,600	\$ 196,840	\$ 56,240	\$ 253,080	\$ 4,921,000
6	600 Process and Raw Water	\$ 1,518,000	\$ 75,900	\$ 30,360	\$ 151,800	\$ 531,300	\$ 75,900	\$ 106,260	\$ 30,360	\$ 136,620	\$ 2,656,500
7	700 Reagents	\$ 2,590,200	\$ 129,510	\$ 51,804	\$ 259,020	\$ 906,570	\$ 129,510	\$ 181,314	\$ 51,804	\$ 233,118	\$ 4,532,850
8	800 Services	\$ 1,633,000	\$ 81,650	\$ 32,660	\$ 163,300	\$ 571,550	\$ 81,650	\$ 114,310	\$ 32,660	\$ 146,970	\$ 2,857,750
9	First Fill	\$ 7,600,000								\$ 684,000	\$ 8,284,000
Infrastructure											
10	Misc	\$ 328,000	\$ 16,400	\$ 6,560	\$ 32,800						\$ 383,760
11	Mobile Equipment	\$ 795,000									\$ 795,000
12	Laboratory	\$ 136,000	\$ 6,800	\$ 2,720	\$ 13,600						\$ 159,120
13	Power Supply (overhead and underground)	\$ 1,000,000	\$ 50,000	\$ 20,000		\$ 350,000					\$ 1,420,000
14	System Communications	\$ 40,000									\$ 40,000
15	Workshop and Store	\$ 160,000	\$ 8,000	\$ 3,200	\$ 16,000					\$ 14,400	\$ 201,600
<b>Direct Cost Total</b>		<b>\$ 86,016,200</b>	<b>\$ 3,879,060</b>	<b>\$ 1,551,624</b>	<b>\$ 7,658,120</b>	<b>\$ 26,935,020</b>	<b>\$ 3,797,860</b>	<b>\$ 5,317,004</b>	<b>\$ 1,519,144</b>	<b>\$ 7,534,548</b>	<b>\$ 142,300,580</b>
Indirect Costs											
1	Working Capital	10%				10% of Direct Costs					\$ 14,230,058.00
2	Insurance	3%				3% of Equipment Cost					\$ 4,269,017.40
3	EPCM	10%				10% of Direct Costs					\$ 14,230,058.00
4	Contingency	10%				10% of Direct Costs					\$ 14,230,058.00
5	Commissioning	2%				2% of Direct Costs					\$ 2,846,011.60
6	Workforce accomm & meals, temp services	2%				2% of Direct Costs					\$ 2,846,011.60
7	Spares and tools	2%				2% of Equipment Cost					\$ 1,720,324.00
<b>Indirect Cost Total</b>											<b>\$ 54,371,539</b>
<b>TOTAL COST</b>										<b>USD</b>	<b>\$ 196,672,119</b>

23.6 Capital Cost – Option 4

				<b>Haib Copper Project</b>							
				<b>20 Mtpa @ 80% Copper Recovery + CuSO4</b>							
		Date 20/04/2020		Project Number J5329			CAPITAL COST ESTIMATE				
<b>Whole Ore Heap Leach</b>											
	AREA	Equipment	Earthworks 5 %	Concrete 2 %	Structural Steelwork 10 %	Mechanical Installation 35 %	Pipework 5 %	Electrical and Instrumentation 7 %	Roads, etc 2 %	Freight 9 %	Total per Item 75 % USD
		USD	USD	USD	USD	USD	USD	USD	USD	USD	
	<b>Direct Costs</b>										
1	100 Crushing	\$ 33,812,000	\$ 1,690,600	\$ 676,240	\$ 3,381,200	\$ 11,834,200	\$ 1,690,600	\$ 2,366,840	\$ 676,240	\$ 3,043,080	\$ 58,583,000
2	200 HPGR	\$ 24,532,000	\$ 1,226,600	\$ 490,640	\$ 2,453,200	\$ 8,586,200	\$ 1,226,600	\$ 1,717,240	\$ 490,640	\$ 2,207,880	\$ 42,431,000
3	300 Agglomeration and Heap Leaching	\$ 24,974,000	\$ 1,248,700	\$ 499,480	\$ 2,497,400	\$ 8,740,900	\$ 1,248,700	\$ 1,748,180	\$ 499,480	\$ 2,247,660	\$ 43,204,500
4	400 Copper Solvent Extraction	\$ 41,819,000	\$ 2,090,950	\$ 836,380	\$ 4,181,900	\$ 14,636,650	\$ 2,090,950	\$ 2,927,330	\$ 836,380	\$ 3,763,710	\$ 72,863,250
5	500 Iron Removal and Tailings	\$ 3,583,000	\$ 179,150	\$ 71,660	\$ 358,300	\$ 1,254,050	\$ 179,150	\$ 250,810	\$ 71,660	\$ 322,470	\$ 6,270,250
6	600 Process and Raw Water	\$ 2,357,000	\$ 117,850	\$ 47,140	\$ 235,700	\$ 824,950	\$ 117,850	\$ 164,990	\$ 47,140	\$ 212,130	\$ 4,124,750
7	700 Reagents	\$ 2,861,200	\$ 143,060	\$ 57,224	\$ 286,120	\$ 1,001,420	\$ 143,060	\$ 200,284	\$ 57,224	\$ 257,508	\$ 5,007,100
8	800 Services	\$ 1,633,000	\$ 81,650	\$ 32,660	\$ 163,300	\$ 571,550	\$ 81,650	\$ 114,310	\$ 32,660	\$ 146,970	\$ 2,857,750
9	First Fill	\$ 7,600,000								\$ 684,000	\$ 8,284,000
	Infrastructure										
10	Misc	\$ 328,000	\$ 16,400	\$ 6,560	\$ 32,800						\$ 383,760
11	Mobile Equipment	\$ 795,000									\$ 795,000
12	Laboratory	\$ 136,000	\$ 6,800	\$ 2,720	\$ 13,600						\$ 159,120
13	Power Supply (overhead and underground)	\$ 1,000,000	\$ 50,000	\$ 20,000		\$ 350,000					\$ 1,420,000
14	System Communications	\$ 40,000									\$ 40,000
15	Workshop and Store	\$ 160,000	\$ 8,000	\$ 3,200	\$ 16,000					\$ 14,400	\$ 201,600
	<b>Direct Cost Total</b>	<b>\$ 145,630,200</b>	<b>\$ 6,859,760</b>	<b>\$ 2,743,904</b>	<b>\$ 13,619,520</b>	<b>\$ 47,799,920</b>	<b>\$ 6,778,560</b>	<b>\$ 9,489,984</b>	<b>\$ 2,711,424</b>	<b>\$ 12,899,808</b>	<b>\$ 246,625,080</b>
	<b>Indirect Costs</b>										
1	Working Capital	10%				10% of Direct Costs					\$ 24,662,508.00
2	Insurance	3%				3% of Equipment Cost					\$ 7,398,752.40
3	EPCM	10%				10% of Direct Costs					\$ 24,662,508.00
4	Contingency	10%				10% of Direct Costs					\$ 24,662,508.00
5	Commissioning	2%				2% of Direct Costs					\$ 4,932,501.60
6	Workforce accomm & meals, temp services	2%				2% of Direct Costs					\$ 4,932,501.60
7	Spares and tools	2%				2% of Equipment Cost					\$ 2,912,604.00
	<b>Indirect Cost Total</b>										<b>\$ 94,163,884</b>
	<b>TOTAL COST</b>									<b>USD</b>	<b>\$ 340,788,964</b>



23.7 Capital Cost – Option 5

				Haib Copper Project							
				20 Mtpa @ 85% Copper Recovery							
		Date 13/03/2020	Project Number J5329		CAPITAL COST ESTIMATE						
Whole Ore Heap Leach											
AREA	Equipment	Earthworks	Concrete	Structural Steelwork	Mechanical Installation	Pipework	Electrical and Instrumentation	Roads, etc	Freight	Total per Item 75 % USD	
		5 %	2 %	10 %	35 %	5 %	7 %	2 %	9 %		
Direct Costs		USD	USD	USD	USD	USD	USD	USD	USD	USD	
1	100 Crushing	\$ 33,812,000	\$ 1,690,600	\$ 676,240	\$ 3,381,200	\$ 11,834,200	\$ 1,690,600	\$ 2,366,840	\$ 676,240	\$ 3,043,080	\$ 58,583,000
2	200 HPGR	\$ 24,532,000	\$ 1,226,600	\$ 490,640	\$ 2,453,200	\$ 8,586,200	\$ 1,226,600	\$ 1,717,240	\$ 490,640	\$ 2,207,880	\$ 42,431,000
3	300 Agglomeration and Heap Leaching	\$ 25,049,000	\$ 1,252,450	\$ 500,980	\$ 2,504,900	\$ 8,767,150	\$ 1,252,450	\$ 1,753,430	\$ 500,980	\$ 2,254,410	\$ 43,335,750
4	400 Copper Solvent Extraction	\$ 41,326,000	\$ 2,066,300	\$ 826,520	\$ 4,132,600	\$ 14,464,100	\$ 2,066,300	\$ 2,892,820	\$ 826,520	\$ 3,719,340	\$ 72,000,500
5	500 Iron Removal and Tailings	\$ 3,613,000	\$ 180,650	\$ 72,260	\$ 361,300	\$ 1,264,550	\$ 180,650	\$ 252,910	\$ 72,260	\$ 325,170	\$ 6,322,750
6	600 Process and Raw Water	\$ 2,343,000	\$ 117,150	\$ 46,860	\$ 234,300	\$ 820,050	\$ 117,150	\$ 164,010	\$ 46,860	\$ 210,870	\$ 4,100,250
7	700 Reagents	\$ 2,772,200	\$ 138,610	\$ 55,444	\$ 277,220	\$ 970,270	\$ 138,610	\$ 194,054	\$ 55,444	\$ 249,498	\$ 4,851,350
8	800 Services	\$ 1,633,000	\$ 81,650	\$ 32,660	\$ 163,300	\$ 571,550	\$ 81,650	\$ 114,310	\$ 32,660	\$ 146,970	\$ 2,857,750
9	First Fill	\$ 7,600,000								\$ 684,000	\$ 8,284,000
Infrastructure											
10	Misc	\$ 328,000	\$ 16,400	\$ 6,560	\$ 32,800						\$ 383,760
11	Mobile Equipment	\$ 795,000									\$ 795,000
12	Laboratory	\$ 136,000	\$ 6,800	\$ 2,720	\$ 13,600						\$ 159,120
13	Power Supply (overhead and underground)	\$ 1,000,000	\$ 50,000	\$ 20,000		\$ 350,000					\$ 1,420,000
14	System Communications	\$ 40,000									\$ 40,000
15	Workshop and Store	\$ 160,000	\$ 8,000	\$ 3,200	\$ 16,000					\$ 14,400	\$ 201,600
<b>Direct Cost Total</b>		<b>\$ 145,139,200</b>	<b>\$ 6,835,210</b>	<b>\$ 2,734,084</b>	<b>\$ 13,570,420</b>	<b>\$ 47,628,070</b>	<b>\$ 6,754,010</b>	<b>\$ 9,455,614</b>	<b>\$ 2,701,604</b>	<b>\$ 12,855,618</b>	<b>\$ 245,765,830</b>
Indirect Costs											
1	Working Capital	10%				10% of Direct Costs					\$ 24,576,583.00
2	Insurance	3%				3% of Equipment Cost					\$ 7,372,974.90
3	EPCM	10%				10% of Direct Costs					\$ 24,576,583.00
4	Contingency	10%				10% of Direct Costs					\$ 24,576,583.00
5	Commissioning	2%				2% of Direct Costs					\$ 4,915,316.60
6	Workforce accomm & meals, temp services	2%				2% of Direct Costs					\$ 4,915,316.60
7	Spares and tools	2%				2% of Equipment Cost					\$ 2,902,784.00
<b>Indirect Cost Total</b>											<b>\$ 93,836,141</b>
<b>TOTAL COST</b>										<b>USD</b>	<b>\$ 339,601,971</b>

23.8 Capital Cost – Option 6

				Haib Copper Project							
				20 Mtpa @ 85% Copper Recovery + CuSO4							
		Date 13/03/2020	Project Number J5329		CAPITAL COST ESTIMATE						
<b>Whole Ore Heap Leach</b>											
AREA	Equipment	Earthworks	Concrete	Structural Steelwork	Mechanical Installation	Pipework	Electrical and Instrumentation	Roads, etc	Freight	Total per Item 75 % USD	
		5 %	2 %	10 %	35 %	5 %	7 %	2 %	9 %		
<b>Direct Costs</b>		USD	USD	USD	USD	USD	USD	USD	USD	USD	
1	100 Crushing	\$ 33,812,000	\$ 1,690,600	\$ 676,240	\$ 3,381,200	\$ 11,834,200	\$ 1,690,600	\$ 2,366,840	\$ 676,240	\$ 3,043,080	\$ 58,583,000
2	200 HPGR	\$ 24,532,000	\$ 1,226,600	\$ 490,640	\$ 2,453,200	\$ 8,586,200	\$ 1,226,600	\$ 1,717,240	\$ 490,640	\$ 2,207,880	\$ 42,431,000
3	300 Agglomeration and Heap Leaching	\$ 25,049,000	\$ 1,252,450	\$ 500,980	\$ 2,504,900	\$ 8,767,150	\$ 1,252,450	\$ 1,753,430	\$ 500,980	\$ 2,254,410	\$ 43,335,750
4	400 Copper Solvent Extraction	\$ 41,908,000	\$ 2,095,400	\$ 838,160	\$ 4,190,800	\$ 14,667,800	\$ 2,095,400	\$ 2,933,560	\$ 838,160	\$ 3,771,720	\$ 73,019,000
5	500 Iron Removal and Tailings	\$ 3,613,000	\$ 180,650	\$ 72,260	\$ 361,300	\$ 1,264,550	\$ 180,650	\$ 252,910	\$ 72,260	\$ 325,170	\$ 6,322,750
6	600 Process and Raw Water	\$ 2,357,000	\$ 117,850	\$ 47,140	\$ 235,700	\$ 824,950	\$ 117,850	\$ 164,990	\$ 47,140	\$ 212,130	\$ 4,124,750
7	700 Reagents	\$ 2,924,200	\$ 146,210	\$ 58,484	\$ 292,420	\$ 1,023,470	\$ 146,210	\$ 204,694	\$ 58,484	\$ 263,178	\$ 5,117,350
8	800 Services	\$ 1,633,000	\$ 81,650	\$ 32,660	\$ 163,300	\$ 571,550	\$ 81,650	\$ 114,310	\$ 32,660	\$ 146,970	\$ 2,857,750
9	First Fill	\$ 7,600,000								\$ 684,000	\$ 8,284,000
Infrastructure											
10	Misc	\$ 328,000	\$ 16,400	\$ 6,560	\$ 32,800						\$ 383,760
11	Mobile Equipment	\$ 795,000									\$ 795,000
12	Laboratory	\$ 136,000	\$ 6,800	\$ 2,720	\$ 13,600						\$ 159,120
13	Power Supply (overhead and underground)	\$ 1,000,000	\$ 50,000	\$ 20,000		\$ 350,000					\$ 1,420,000
14	System Communications	\$ 40,000									\$ 40,000
15	Workshop and Store	\$ 160,000	\$ 8,000	\$ 3,200	\$ 16,000					\$ 14,400	\$ 201,600
<b>Direct Cost Total</b>		<b>\$ 145,887,200</b>	<b>\$ 6,872,610</b>	<b>\$ 2,749,044</b>	<b>\$ 13,645,220</b>	<b>\$ 47,889,870</b>	<b>\$ 6,791,410</b>	<b>\$ 9,507,974</b>	<b>\$ 2,716,564</b>	<b>\$ 12,922,938</b>	<b>\$ 247,074,830</b>
<b>Sub Total Direct Cost</b>											
<b>\$ 247,074,830</b>											
<b>Indirect Costs</b>											
1	Working Capital	10%				10% of Direct Costs					\$ 24,707,483.00
2	Insurance	3%				3% of Equipment Cost					\$ 7,412,244.90
3	EPCM	10%				10% of Direct Costs					\$ 24,707,483.00
4	Contingency	10%				10% of Direct Costs					\$ 24,707,483.00
5	Commissioning	2%				2% of Direct Costs					\$ 4,941,496.60
6	Workforce accomm & meals, temp services	2%				2% of Direct Costs					\$ 4,941,496.60
7	Spares and tools	2%				2% of Equipment Cost					\$ 2,917,744.00
<b>Sub Total Indirect Cost</b>											
<b>\$ 94,335,431</b>											
<b>TOTAL COST</b>										<b>USD</b>	<b>\$ 341,410,261</b>

### **23.9 Accuracy Assessment**

At a scoping study level the accuracy is assumed to be at  $\pm 35\%$  of the CAPEX.

## **24. OPERATING COST**

### **24.1 Scope and Methodology**

METS estimated operating costs for crushing, screening, grinding, floating, heap loading, leaching, solvent extraction and refining. It was assumed that the mining would be executed via contract mining and all associated capital was included in the mining operating expense. The estimates were made for a plant with different plant capacities and were made for individual options including:

- Option 1: 8.5 Mtpa with 80% copper recovery with CuSO<sub>4</sub> (base case)
- Option 2: 8.5 Mtpa with 85% copper recovery
- Option 3: 8.5 Mtpa with 85% copper recovery with CuSO<sub>4</sub>
- Option 4: 20 Mtpa with 80% copper recovery with CuSO<sub>4</sub>
- Option 5: 20 Mtpa with 85% copper recovery
- Option 6: 20 Mtpa with 85% copper recovery with CuSO<sub>4</sub>

### **24.2 Basis of Estimate**

Process operating costs were estimated by METS engineering using the equipment list generated from the flowsheets, the manning requirements based on similar projects and from equipment vendors. The cost estimates cover crushing, screening, heap loading, leaching, solvent extraction and refining.

#### **24.2.1 Estimated Labour Rates**

Personnel requirements were assumed for each area. Namibian wages were used to estimate the total payroll. A 30.5% overhead was applied to the annual salary for each person.

#### **24.2.2 Estimated Consumable Costs**

Consumable costs are based on both quotes from vendors and spares prices from previous METS projects that have been converted from AUD to USD (AU \$ 1 = US \$ 0.67). The consumption rates are based on vendor information, past projects and METS experience.

#### **24.2.3 Estimated Reagents Costs**

The reagent costs have been estimated based on direct quotes from suppliers, past projects and from online sources such as Kemcore. All reagents costs are in USD with an allowance for delivery to site from the Luderitz port, unless otherwise specified. The raw water price is

assumed to be equivalent to the average 2016 mine tariff of N\$ 10.09 (based on information provided by DSM) corresponding to US\$ 0.71/kL at the exchange rate utilised throughout the project. The diesel price has been taken as US\$ 0.94/L based on the Namibian diesel price on the 24/01/20.

#### **24.2.4 Estimated Power Cost**

The power is assumed to be able to be taken from the grid from one of the surrounding towns. The 2019/20 tariff for large power used from NamPower of N\$ 1.17/kWh (US\$ 0.084/kWh) was incorporated for the study.

#### **24.2.5 Estimated Maintenance Cost**

The maintenance cost is estimated as a factor of the equipment capital expense for each process area. A larger portion of maintenance was allocated to Area 100 (crushing) and Area 200 (grinding).

### **24.3 Cost Breakdown Structure**

to

Table 24-6 outlines the operating cost structure for the whole ore heap leaching option that was assessed. As previously mentioned, the cost of mining was assumed equal to that of a similar Namibian project.

**Table 24-1: Operating Cost Breakdown – Option 1 (Base Case)**

8.5 Mtpa @ 80% Cu Recovery + CuSO <sub>4</sub>				
Area	Annual Cost		Unit Cost	Unit Cost
		('000 USD)	(USD/t ROM)	(USD/lb CuEq)
Mining		19,210	2.26	0.36
Processing		48,906	5.75	0.93
Product Freight		2,645	0.31	0.05
Wharfage & Shiploading		294	0.035	0.006
Administration		1,700	\$0.20	0.03
Royalty	\$2.00	3,168	0.37	0.06
	\$2.25	3,564	0.42	0.07
	\$2.50	3,960	0.47	0.08
	\$2.85	4,514	0.53	0.09
	\$3.00	4,751	0.56	0.09
	\$3.25	5,147	0.61	0.10
	\$3.50	5,543	0.65	0.11
	\$3.75	5,939	0.70	0.11
	\$4.00	6,335	0.75	0.12
Total	\$2.00	<b>75,922</b>	<b>8.93</b>	<b>1.44</b>
	\$2.25	<b>76,318</b>	<b>8.98</b>	<b>1.45</b>
	\$2.50	<b>76,714</b>	<b>9.03</b>	<b>1.45</b>
	\$2.85	<b>77,268</b>	<b>9.09</b>	<b>1.46</b>
	\$3.00	<b>77,506</b>	<b>9.12</b>	<b>1.47</b>
	\$3.25	<b>77,902</b>	<b>9.16</b>	<b>1.48</b>
	\$3.50	<b>78,298</b>	<b>9.21</b>	<b>1.48</b>
	\$3.75	<b>78,694</b>	<b>9.26</b>	<b>1.49</b>
	\$4.00	<b>79,090</b>	<b>9.30</b>	<b>1.50</b>

**Table 24-2: Operating Cost Breakdown – Option 2**

<b>8.5 Mtpa @ 85% Cu Recovery</b>				
<b>Area</b>		<b>Annual Cost</b>	<b>Unit Cost</b>	<b>Unit Cost</b>
		<b>('000 USD)</b>	<b>(USD/t ROM)</b>	<b>(USD/lb CuEq)</b>
Mining		19,210	2.26	0.40
Processing		43,372	5.10	0.91
Product Freight		977	0.11	0.02
Wharfage & Shiploading		109	0.013	0.002
Administration		1,700	\$0.20	0.04
Royalty	\$2.00	2,871	0.34	0.06
	\$2.25	3,230	0.38	0.07
	\$2.50	3,589	0.42	0.08
	\$2.85	4,092	0.48	0.09
	\$3.00	4,307	0.51	0.09
	\$3.25	4,666	0.55	0.10
	\$3.50	5,025	0.59	0.11
	\$3.75	5,384	0.63	0.11
	\$4.00	5,743	0.68	0.12
<b>Total</b>	\$2.00	<b>68,239</b>	<b>8.03</b>	<b>1.43</b>
	\$2.25	<b>68,597</b>	<b>8.07</b>	<b>1.43</b>
	\$2.50	<b>68,956</b>	<b>8.11</b>	<b>1.44</b>
	\$2.85	<b>69,459</b>	<b>8.17</b>	<b>1.45</b>
	\$3.00	<b>69,674</b>	<b>8.20</b>	<b>1.46</b>
	\$3.25	<b>70,033</b>	<b>8.24</b>	<b>1.46</b>
	\$3.50	<b>70,392</b>	<b>8.28</b>	<b>1.47</b>
	\$3.75	<b>70,751</b>	<b>8.32</b>	<b>1.48</b>
	\$4.00	<b>71,110</b>	<b>8.37</b>	<b>1.49</b>

**Table 24-3: Operating Cost Breakdown – Option 3**

<b>8.5 Mtpa @ 85% Cu Recovery + CuSO<sub>4</sub></b>				
<b>Area</b>		<b>Annual Cost</b>	<b>Unit Cost</b>	<b>Unit Cost</b>
		<b>('000 USD)</b>	<b>(USD/t ROM)</b>	<b>(USD/lb CuEq)</b>
Mining		19,210	2.26	0.35
Processing		50,946	5.99	0.92
Product Freight		2,702	0.32	0.05
Wharfage & Shiploading		300	0.035	0.005
Administration		1,700	\$0.20	0.03
Royalty	\$2.00	3,337	0.39	0.06
	\$2.25	3,754	0.44	0.07
	\$2.50	4,171	0.49	0.08
	\$2.85	4,755	0.56	0.09
	\$3.00	5,005	0.59	0.09
	\$3.25	5,422	0.64	0.10
	\$3.50	5,839	0.69	0.11
	\$3.75	6,256	0.74	0.11
	\$4.00	6,673	0.79	0.12
<b>Total</b>	\$2.00	<b>78,194</b>	<b>9.20</b>	<b>1.41</b>
	\$2.25	<b>78,612</b>	<b>9.25</b>	<b>1.41</b>
	\$2.50	<b>79,029</b>	<b>9.30</b>	<b>1.42</b>
	\$2.85	<b>79,612</b>	<b>9.37</b>	<b>1.43</b>
	\$3.00	<b>79,863</b>	<b>9.40</b>	<b>1.44</b>
	\$3.25	<b>80,280</b>	<b>9.44</b>	<b>1.44</b>
	\$3.50	<b>80,697</b>	<b>9.49</b>	<b>1.45</b>
	\$3.75	<b>81,114</b>	<b>9.54</b>	<b>1.46</b>
	\$4.00	<b>81,531</b>	<b>9.59</b>	<b>1.47</b>



**Table 24-4: Operating Cost Breakdown – Option 4**

<b>20 Mtpa @ 80% Cu Recovery + CuSO<sub>4</sub></b>				
<b>Area</b>	<b>Annual Cost</b>		<b>Unit Cost</b>	<b>Unit Cost</b>
	<b>(‘000 USD)</b>	<b>(USD/t ROM)</b>	<b>(USD/lb CuEq)</b>	
Mining	45,200	2.26	0.40	
Processing	90,799	4.54	0.80	
Product Freight	3,889	0.19	0.03	
Wharfage & Shiploading	432	0.022	0.004	
Administration	4,000	\$0.20	0.04	
Royalty	\$2.00	6,824	0.34	0.06
	\$2.25	7,677	0.38	0.07
	\$2.50	8,530	0.43	0.08
	\$2.85	9,724	0.49	0.09
	\$3.00	10,236	0.51	0.09
	\$3.25	11,089	0.55	0.10
	\$3.50	11,942	0.60	0.11
	\$3.75	12,795	0.64	0.11
	\$4.00	13,648	0.68	0.12
<b>Total</b>	\$2.00	<b>151,144</b>	<b>7.56</b>	<b>1.33</b>
	\$2.25	<b>151,997</b>	<b>7.60</b>	<b>1.34</b>
	\$2.50	<b>152,850</b>	<b>7.64</b>	<b>1.34</b>
	\$2.85	<b>154,044</b>	<b>7.70</b>	<b>1.35</b>
	\$3.00	<b>154,556</b>	<b>7.73</b>	<b>1.36</b>
	\$3.25	<b>155,409</b>	<b>7.77</b>	<b>1.37</b>
	\$3.50	<b>156,262</b>	<b>7.81</b>	<b>1.37</b>
	\$3.75	<b>157,115</b>	<b>7.86</b>	<b>1.38</b>
	\$4.00	<b>157,968</b>	<b>7.90</b>	<b>1.39</b>

**Table 24-5: Operating Cost Breakdown – Option 5**

<b>20 Mtpa @ 85% Cu Recovery</b>				
<b>Area</b>		<b>Annual Cost</b>	<b>Unit Cost</b>	<b>Unit Cost</b>
		<b>('000 USD)</b>	<b>(USD/t ROM)</b>	<b>(USD/lb CuEq)</b>
Mining		45,200	2.26	0.40
Processing		87,054	4.35	0.77
Product Freight		2,298	0.11	0.02
Wharfage & Shiploading		255	0.013	0.002
Administration		4,000	\$0.20	0.04
Royalty	\$2.00	6,756	0.34	0.06
	\$2.25	7,601	0.38	0.07
	\$2.50	8,445	0.42	0.08
	\$2.85	9,628	0.48	0.09
	\$3.00	10,135	0.51	0.09
	\$3.25	10,979	0.55	0.10
	\$3.50	11,824	0.59	0.11
	\$3.75	12,668	0.63	0.11
	\$4.00	13,513	0.68	0.12
<b>Total</b>	\$2.00	<b>145,565</b>	<b>7.28</b>	<b>1.29</b>
	\$2.25	<b>146,409</b>	<b>7.32</b>	<b>1.30</b>
	\$2.50	<b>147,254</b>	<b>7.36</b>	<b>1.31</b>
	\$2.85	<b>148,436</b>	<b>7.42</b>	<b>1.32</b>
	\$3.00	<b>148,943</b>	<b>7.45</b>	<b>1.32</b>
	\$3.25	<b>149,787</b>	<b>7.49</b>	<b>1.33</b>
	\$3.50	<b>150,632</b>	<b>7.53</b>	<b>1.34</b>
	\$3.75	<b>151,477</b>	<b>7.57</b>	<b>1.35</b>
	\$4.00	<b>152,321</b>	<b>7.62</b>	<b>1.35</b>

**Table 24-6: Operating Cost Breakdown – Option 6**

<b>20 Mtpa @ 85% Cu Recovery + CuSO4</b>				
<b>Area</b>	<b>Annual Cost</b>		<b>Unit Cost</b>	<b>Unit Cost</b>
		<b>('000 USD)</b>	<b>(USD/t ROM)</b>	<b>(USD/lb CuEq)</b>
Mining		45,200	2.26	0.38
Processing		95,585	4.78	0.79
Product Freight		4,024	0.20	0.03
Wharfage & Shiploading		447	0.022	0.004
Administration		4,000	\$0.20	0.03
Royalty	\$2.00	7,221	0.36	0.06
	\$2.25	8,124	0.41	0.07
	\$2.50	9,027	0.45	0.08
	\$2.85	10,291	0.51	0.09
	\$3.00	10,832	0.54	0.09
	\$3.25	11,735	0.59	0.10
	\$3.50	12,637	0.63	0.11
	\$3.75	13,540	0.68	0.11
	\$4.00	14,443	0.72	0.12
<b>Total</b>	\$2.00	<b>156,478</b>	<b>7.82</b>	<b>1.30</b>
	\$2.25	<b>157,380</b>	<b>7.87</b>	<b>1.31</b>
	\$2.50	<b>158,283</b>	<b>7.91</b>	<b>1.32</b>
	\$2.85	<b>159,547</b>	<b>7.98</b>	<b>1.33</b>
	\$3.00	<b>160,088</b>	<b>8.00</b>	<b>1.33</b>
	\$3.25	<b>160,991</b>	<b>8.05</b>	<b>1.34</b>
	\$3.50	<b>161,894</b>	<b>8.09</b>	<b>1.35</b>
	\$3.75	<b>162,796</b>	<b>8.14</b>	<b>1.35</b>
	\$4.00	<b>163,699</b>	<b>8.18</b>	<b>1.36</b>

## 24.4 Operating Cost – Option 1 (Base Case)

Title: **OPEX - 8.5 Mtpa @ 80% Cu Recovery + CuSO4**  
 Document No.: **J5329-ES-CA-000-001**  
 Project: **Haib PEA**  
 Client: **Deep-South Resources**  
 Date: **21-Apr-20**  
 Rev: **A**  
 Option: **Whole Ore Heap Leach**  
 Accuracy: **± 30%**  
 Comments:

Key Inputs and Outputs			
Plant Throughput dry	8,500,000	tpa	
Utilisation (Crushing)	6,132	h/a	
Utilisation (Grinding)	7,894	h/a	
Plant Throughput dry	1,078	dlph	
Head Grade	0.310%	% Cu	
Recovery	80	% Cu	
Annual Production	7,690	t Cu	
	16,954,471	t CuSO4.5H2O	
	51,081	t CuSO4.5H2O	
	112,613,875	lb CuSO4.5H2O	
	52,780,705	Total lb Cu Eq	
Power Cost	\$0.084	USD/kWh	
Total Power	11.66	MWh/yr	
Abrasion Index	0.49		
Fixed Component	\$8,135,850	USD/a	
Fixed Component	\$0.96	USD/t ROM	
Variable Component	\$40,770,003	USD/a ROM	
Variable Component	\$4.80	USD/t ROM	
Operating Cost Estimation	\$5.75	USD/t ROM	
Operating Cost Estimation	\$0.93	USD/lb Cu Eq	

Miscellaneous Costs Only		
	Cost USD/a	USD/t ROM
Laboratory Costs	\$1,000,000	\$0.12
Contractors	\$100,000	\$0.01
Vehicle Fleet	\$100,000	\$0.01
<b>Total</b>	<b>\$1,200,000</b>	<b>\$0.14</b>

Summary 1 - Cost per pound of copper produced (Based on Commodity)					
	Cost		Fixed %	Fixed Cost USD/a	Variable Cost USD/a
Power	\$8,358,605	\$0.16	15.0	\$1,253,791	\$7,104,814
Consumables	\$7,326,841	\$0.14	5.0	\$366,342	\$6,960,499
Reagents	\$24,523,449	\$0.46	0.0	\$0	\$24,523,449
Labour	\$4,930,792	\$0.09	100.0	\$4,930,792	\$0
Maintenance	\$2,566,166	\$0.05	15.0	\$384,925	\$2,181,241
Misc	\$1,200,000	\$0.02	100.0	\$1,200,000	\$0
<b>Total</b>	<b>\$48,905,853</b>	<b>\$0.93</b>	<b>16.6</b>	<b>\$8,135,850</b>	<b>\$40,770,003</b>

Summary 1 - Cost per tonne of Concentrate (Based on Commodity)					
	Cost		Fixed Cost USD/a	Variable Cost USD/a	Overall Distribution %
Power	\$8,358,605	\$0.98	\$1,253,791	\$7,104,814	17.1
Consumables	\$7,326,841	\$0.86	\$366,342	\$6,960,499	15.0
Reagents	\$24,523,449	\$2.89	\$0	\$24,523,449	50.1
Labour	\$4,930,792	\$0.58	\$4,930,792	\$0	10.1
Maintenance	\$2,566,166	\$0.30	\$384,925	\$2,181,241	5.2
Miscellaneous	\$1,200,000	\$0.14	\$1,200,000	\$0	2.5
<b>Total</b>	<b>\$48,905,853</b>	<b>\$5.75</b>	<b>\$8,135,850</b>	<b>\$40,770,003</b>	<b>100.0</b>

Reagents					
	Price USD/unit	Unit	Consumption (unit/a)	USD/a	Cost USD/t ROM
Sulphuric Acid	\$275	t	28725	\$7,349,248	0.86
Polyacrylamide	\$2,150	t	1240	\$2,666,453	0.31
LDX84N	\$12,000	t	233	\$2,807,544	0.33
Quicklime	\$300	t	6902	\$2,036,228	0.24
Limestone	\$150	t	19786	\$3,068,255	0.45
Calcrete/Dolomite	\$13	t	0	\$0	0.00
Kerosene	\$550	t	1321	\$785,895	0.09
Raw Water	\$1	kl	1113460	\$1,020,264	0.12
Fluoculant	\$2,150	t	51	\$109,181	0.01
Diesel	\$1	L	3923449	\$3,890,380	0.46
<b>Total</b>				<b>\$24,823,449</b>	<b>\$2.89</b>

Maintenance					
	Mechanical Capital USD	Maintenance %	USD/a	USD/t ROM	Cost
Crushing	\$16,810,000	5%	\$845,500	\$0.10	
HPGR	\$12,991,000	5%	\$649,550	\$0.08	
Agglomeration and Heap Leaching	\$13,316,000	1%	\$133,160	\$0.02	
Copper SX, EW and Crystallisation	\$23,724,000	3%	\$711,720	\$0.08	
Iron Removal and Tailings	\$2,812,000	3%	\$84,360	\$0.01	
Process and Raw Water	\$1,618,000	1%	\$15,180	\$0.00	
Reagents	\$2,590,000	3%	\$77,706	\$0.01	
Services	\$1,633,000	3%	\$48,990	\$0.01	
<b>Total</b>	<b>\$75,494,200</b>	<b>3.40%</b>	<b>\$2,566,166</b>	<b>\$0.30</b>	

Plant Standby Cost				
	Assumptions and Bases	% of annual total cost	Standby Cost USD/a	Dist %
Power	Agitators, thickeners and lighting persist	15.0	\$1,253,791	15.4
Consumables	Air and water service costs persist	5.0	\$366,342	4.5
Reagents	No reagent consumption due to no throughput	0.0	\$0	0.0
Labour	All staff retain their positions	100.0	\$4,930,792	60.6
Maintenance	Operational equipment maintenance	15.0	\$384,925	4.7
Miscellaneous	Contract agreements	100.0	\$1,200,000	14.7
<b>Total</b>		<b>16.6</b>	<b>\$8,135,850</b>	<b>100.0</b>

Power						
	Installed kW	Utilisation %	kW Draw	Total kWh/a	Cost USD/a	Cost USD/t ROM
Crushing	3,666	70	2,566	15,736,517	\$1,327,596	\$0.16
HPGR	4,661	90	4,195	33,073,727	\$2,790,232	\$0.33
Agglomeration and Heap Leaching	2,057	98	2,016	17,306,192	\$1,460,020	\$0.17
Copper SX, EW and Crystallisation	4,056	90	3,650	28,775,921	\$2,427,652	\$0.29
Iron Removal and Tailings	202	90	182	1,434,560	\$121,025	\$0.01
Process and Raw Water	335	90	302	2,378,374	\$200,649	\$0.02
Reagents	30	90	27	215,561	\$18,196	\$0.00
Services	28	70	20	157,007	\$13,246	\$0.00
<b>Total</b>	<b>16,036</b>		<b>12,958</b>	<b>99,077,860</b>	<b>\$8,358,605</b>	<b>\$0.98</b>

Consumables						
	Unit	Price USD/unit	Consumption (unit/a)	Cost USD/a	Freight USD/a	USD/t ROM
Gyratory Crusher Liner - Mantle	set	\$200,000.00	2	\$400,000	\$36,000	\$0.05
Gyratory Crusher Liner - Concave	set	\$200,000.00	4	\$800,000	\$72,000	\$0.10
Cone Crusher Liners - Bowl	set	\$18,000.00	6	\$108,000	\$9,720	\$0.01
Cone Crusher Liners - Mantle	set	\$18,000.00	6	\$108,000	\$9,720	\$0.01
Secondary Screen	set	\$20,000.00	8	\$160,000	\$14,400	\$0.02
HPGR Liner and Plates	set	\$1,149,512.00	1	\$574,756	\$51,728	\$0.07
HPGR Double Deck Screen Liner	set	\$25,000.00	16	\$400,000	\$36,000	\$0.05
Pad Clearance	m2	\$0.65	150840	\$98,046	\$0.00	\$0.01
Pad Earthworks	m3	\$2.50	268610	\$671,525	\$0.00	\$0.08
Pad Liner	m2	\$8.40	150840	\$1,267,056	\$114,035	\$0.16
Irrigation Tubing	m	\$7.00	5384	\$37,688	\$3,392	\$0.00
Replacement Cathodes	set	\$150.00	530	\$79,500	\$7,155	\$0.01
Replacement Anodes	set	\$200.00	663	\$132,600	\$11,925	\$0.02
Copper Sulfate Bags	each	\$12.50	51081	\$638,511	\$57,466	\$0.08
Copper Sulfate Pallets	each	\$15.00	51081	\$766,213	\$68,959	\$0.10
Oil	t	\$800.00	384	\$304,107	\$31,875	\$0.05
Grease	t	\$450.00	394	\$177,085	\$15,938	\$0.02
Air Filters	set	\$3,745.28	1	\$1,873	\$169	\$0.00
Mobile Lighting Tower Parts	set	\$700.00	3	\$2,100	\$189	\$0.00
Light Vehicle Parts	set	\$350.00	6	\$2,100	\$189	\$0.00
Water Truck Parts	set	\$2,100.00	1	\$2,100	\$189	\$0.00
Forklift Parts	set	\$1,750.00	2	\$3,500	\$315	\$0.00
Ambulance Parts/Consumables	set	\$700.00	1	\$700	\$63	\$0.00
<b>Total</b>					<b>\$7,326,841</b>	<b>\$0.96</b>

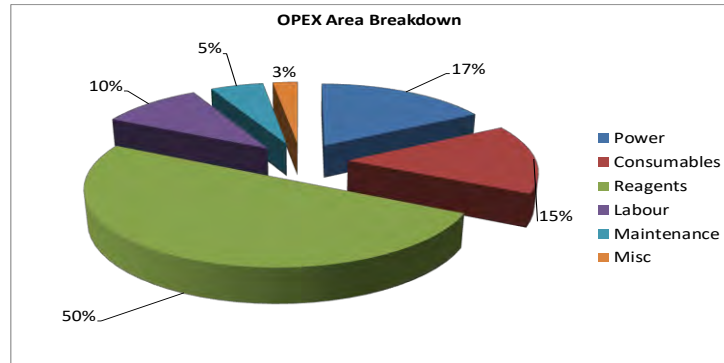

Rev	Date	Engineer	Comments
A	21/04/20	DC	Issue as draft to client
A	8/04/20	BM	Began populating updated layout

**24.5 Operating Cost – Option 2**

DRAFT

Title: OPEX - 8.5 Mtpa @ 85% Cu Recovery  
 Document No.: J5329-ES-CA-000-001  
 Project: Haib PEA  
 Client: Deep-South Resources  
 Date: 13-Mar-20  
 Rev: A  
 Option: Whole Ore Heap Leach  
 Accuracy: ± 30%  
 Comments:

Summary 1 - Cost per pound of Copper produced (Based on Commodity)					
	Cost		Fixed %	Fixed Cost USD/a	Variable Cost USD/a
	USD/a	USD/lb Cu Eq			
Power	\$10,712,307	\$0.22	15.0	\$1,606,846	\$9,105,461
Consumables	\$6,116,589	\$0.13	5.0	\$305,829	\$5,810,759
Reagents	\$17,812,870	\$0.37	0.0	\$0	\$17,812,870
Labour	\$4,930,792	\$0.10	100.0	\$4,930,792	\$0
Maintenance	\$2,599,126	\$0.05	15.0	\$389,869	\$2,209,257
Misc	\$1,200,000	\$0.03	100.0	\$1,200,000	\$0
<b>Total</b>	<b>\$43,371,684</b>	<b>\$0.91</b>	<b>19.4</b>	<b>\$8,433,337</b>	<b>\$34,938,348</b>

Summary 1 - Cost per tonne of Concentrate (Based on Commodity)					
	Cost		Fixed Cost USD/a	Variable Cost USD/a	Overall Distribution %
	USD/a	USD/t ROM			
Power	\$10,712,307	\$1.26	\$1,606,846	\$9,105,461	24.7
Consumables	\$6,116,589	\$0.72	\$305,829	\$5,810,759	14.1
Reagents	\$17,812,870	\$2.10	\$0	\$17,812,870	41.1
Labour	\$4,930,792	\$0.58	\$4,930,792	\$0	11.4
Maintenance	\$2,599,126	\$0.31	\$389,869	\$2,209,257	6.0
Miscellaneous	\$1,200,000	\$0.14	\$1,200,000	\$0	2.8
<b>Total</b>	<b>\$43,371,684</b>	<b>\$5.10</b>	<b>\$8,433,337</b>	<b>\$34,938,348</b>	<b>100.0</b>

Reagents					
	Price USD/unit	Unit	Consumption (unit/a)	Cost	
				USD/a	USD/t ROM
Sulphuric Acid	\$275	t	8044	\$2,212,002	0.26
Polycrylamide	\$2,150	t	1247	\$2,680,015	0.32
LDX94N	\$12,000	t	233	\$2,807,544	0.33
Quicklime	\$300	t	6127	\$2,113,980	0.25
Limestone	\$150	t	28614	\$5,579,686	0.66
Calcrete/Dolomite	\$13	t	0	\$0	0.00
Kerosene	\$550	t	1321	\$785,895	0.09
Raw Water	\$1	kL	1007349	\$923,034	0.11
Flocculant	\$2,150	t	54	\$115,771	0.01
Diesel	\$1	L	600000	\$594,943	0.07
<b>Total</b>				<b>\$17,812,870</b>	<b>\$2.10</b>

Maintenance				
	Mechanical Capital USD	Maintenance %	Cost	
			USD/a	USD/t ROM
Crushing	\$16,910,000	5%	\$845,500	\$0.10
HPGR	\$12,991,000	5%	\$649,550	\$0.08
Agglomeration and Heap Leaching	\$13,316,000	1%	\$133,160	\$0.02
Copper SX and EW	\$25,020,000	3%	\$750,600	\$0.09
Iron Removal and Tailings	\$2,812,000	3%	\$84,360	\$0.01
Process and Raw Water	\$1,502,000	1%	\$15,020	\$0.00
Reagents	\$2,398,200	3%	\$71,946	\$0.01
Services	\$1,633,000	3%	\$48,990	\$0.01
<b>Total</b>	<b>\$76,682,200</b>	<b>3.39%</b>	<b>\$2,599,126</b>	<b>\$0.31</b>

Plant Standby Cost				
	Assumptions and Bases	% of annual total cost	Standby Cost USD/a	Dist %
Consumables	Air and water service costs persist	5.0	\$305,829	3.6
Reagents	No reagent consumption due to no throughput	0.0	\$0	0.0
Labour	All staff retain their positions	100.0	\$4,930,792	58.5
Maintenance	Operational equipment maintenance	15.0	\$389,869	4.6
Miscellaneous	Contract agreements	100.0	\$1,200,000	14.2
<b>Total</b>		<b>19.4</b>	<b>\$8,433,337</b>	<b>100.0</b>

	Installed kW	Utilisation %	kW Draw	Total kW/a	Cost	
					USD/a	USD/t ROM
					USD/a	
Crushing	3,666	70	2,566	15,736,517	\$1,327,596	\$0.16
HPGR	4,661	90	4,195	33,073,727	\$2,790,232	\$0.33
Agglomeration and Heap Leaching	2,310	98	2,264	19,436,769	\$1,639,764	\$0.19
Copper SX and EW	7,699	90	6,929	54,629,811	\$4,608,789	\$0.54
Iron Removal and Tailings	202	90	182	1,434,560	\$121,025	\$0.01
Process and Raw Water	333	90	300	2,363,952	\$199,432	\$0.02
Reagents	20	90	18	144,889	\$12,223	\$0.00
Services	28	70	20	157,007	\$13,246	\$0.00
<b>Total</b>	<b>18,921</b>		<b>16,475</b>	<b>126,977,233</b>	<b>\$10,712,307</b>	<b>\$1.26</b>

Consumables						
	Unit	Price USD/unit	Consumption (unit/a)	Cost		
				USD/a	Freight	USD/t ROM
Gyratory Crusher Liner - Mantle	set	\$200,000.00	2	\$400,000	\$36,000	\$0.05
Gyratory Crusher Liner - Concave	set	\$200,000.00	4	\$800,000	\$72,000	\$0.10
Cone Crusher Liners - Bowl	set	\$18,000.00	6	\$108,000	\$9,720	\$0.01
Cone Crusher Liners - Mantle	set	\$18,000.00	6	\$108,000	\$9,720	\$0.01
Secondary Screen	set	\$20,000.00	8	\$160,000	\$14,400	\$0.02
HPGR Liner and Plates	set	\$1,149,512.00	1	\$1,149,512	\$51,726	\$0.07
HPGR Double Deck Screen Liner	set	\$25,000.00	16	\$400,000	\$36,000	\$0.05
Pad Clearance	m2	\$0.65	150840	\$98,046	\$0	\$0.01
Pad Earthworks	m3	\$2.50	268810	\$671,525	\$0	\$0.08
Pad Liner	m2	\$8.40	150840	\$1,267,056	\$114,035	\$0.16
Irrigation Tubing	m	\$7.00	5384	\$37,685	\$3,392	\$0.00
Replacement Cathodes	set	\$150.00	1268	\$189,900	\$17,091	\$0.02
Replacement Anodes	set	\$200.00	1583	\$316,500	\$28,485	\$0.04
Oil	t	\$900.00	394	\$354,167	\$31,875	\$0.05
Grease	t	\$450.00	384	\$177,083	\$15,936	\$0.02
Air Filters	set	\$3,745.28	1	\$3,745	\$169	\$0.00
Mobile Lighting Tower Parts	set	\$700.00	3	\$2,100	\$189	\$0.00
Light Vehicle Parts	set	\$350.00	6	\$2,100	\$189	\$0.00
Water Truck Parts	set	\$2,100.00	1	\$2,100	\$189	\$0.00
Forklift Parts	set	\$1,750.00	2	\$3,500	\$315	\$0.00
Ambulance Parts/Consumables	set	\$700.00	1	\$700	\$63	\$0.00
<b>Total</b>				<b>\$6,116,589</b>	<b>\$0.72</b>	

Key Inputs and Outputs			
Plant Throughput dry	8,500,000	tpa	
Utilisation (Crushing)	6,132	h/a	
Utilisation (Grinding)	7,884	h/a	
Plant Throughput dry	1,078	tdph	
Head Grade	0.310%	% Cu	
Recovery	0.0	% Cu	
Annual Production	21,708	t Cu	
	47,857,570	tp Cu	
Power Cost	\$0.084	USD/kWh	
Total Power	14.94	kWh/t	
Abrasion Index	0.49		
Fixed Component	\$8,433,337	USD/a	
Fixed Component	\$0.99	USD/t ROM	
Variable Component	\$34,938,348	USD/a	
Variable Component	\$4.11	USD/t ROM	
<b>Operating Cost Estimation</b>	<b>\$5.10</b>	<b>USD/t ROM</b>	
<b>Operating Cost Estimation</b>	<b>\$0.91</b>	<b>USD/lb Cu Eq</b>	

Miscellaneous Costs Only		
	Cost	
	USD/a	USD/t ROM
Laboratory Costs	\$1,000,000	\$0.12
Contractors	\$100,000	\$0.01
Vehicle Fleet	\$100,000	\$0.01
<b>Total</b>	<b>\$1,200,000</b>	<b>\$0.14</b>

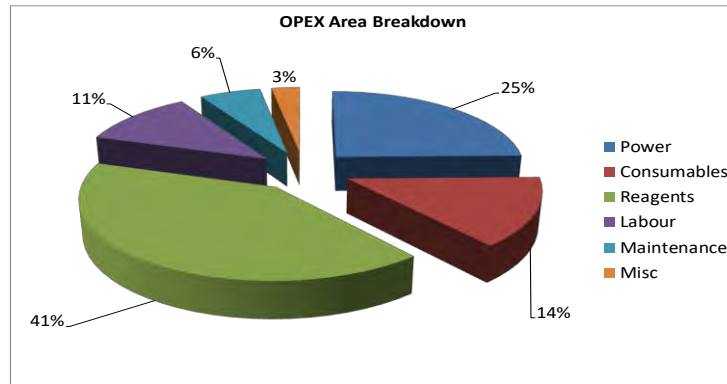

Rev	Date	Engineer	Comments
A	13/03/20	DC	Issue as draft to client
A	10/01/20	LZ	Began populating updated layout

**24.6 Operating Cost – Option 3**

DRAFT



Title: **OPEX - 8.5 Mtpa @ 85% Cu Recovery + CuSO4**  
 Document No.: **J5329-ES-CA-000-001**  
 Project: **Haib PEA**  
 Client: **Deep-South Resources**  
 Date: **13-Mar-20**  
 Rev: **A**  
 Option: **Whole Ore Heap Leach**  
 Accuracy: **± 30%**  
 Comments:

	Summary 1 - Cost per pound of copper produced (Based on Commodity)				
	Cost		Fixed %	Fixed Cost USD/a	Variable Cost USD/a
Power	\$8,576,774	\$0.15	15.0	\$1,286,516	\$7,290,258
Consumables	\$7,326,841	\$0.13	5.0	\$366,342	\$6,960,499
Reagents	\$26,331,076	\$0.47	0.0	\$0	\$26,331,076
Labour	\$4,930,792	\$0.09	100.0	\$4,930,792	\$0
Maintenance	\$2,580,056	\$0.05	15.0	\$387,038	\$2,193,048
Misc	\$1,200,000	\$0.02	100.0	\$1,200,000	\$0
<b>Total</b>	<b>\$50,945,540</b>	<b>\$0.92</b>	<b>16.0</b>	<b>\$8,170,659</b>	<b>\$42,774,881</b>

	Summary 1 - Cost per tonne of Concentrate (Based on Commodity)				
	Cost		Fixed Cost USD/a	Variable Cost USD/a	Overall Distribution %
Power	\$8,576,774	\$1.01	\$1,286,516	\$7,290,258	16.8
Consumables	\$7,326,841	\$0.86	\$366,342	\$6,960,499	14.4
Reagents	\$26,331,076	\$3.10	\$0	\$26,331,076	51.7
Labour	\$4,930,792	\$0.58	\$4,930,792	\$0	9.7
Maintenance	\$2,580,056	\$0.30	\$387,038	\$2,193,048	5.1
Miscellaneous	\$1,200,000	\$0.14	\$1,200,000	\$0	2.4
<b>Total</b>	<b>\$50,945,540</b>	<b>\$5.99</b>	<b>\$8,170,659</b>	<b>\$42,774,881</b>	<b>100.0</b>

	Reagents				
	Price USD/unit	Unit	Consumption (unit/a)	USD/a	USD/t ROM
Sulphuric Acid	\$275	t	28725	\$7,349,248	0.86
Polyacrylamide	\$2,150	t	1241	\$2,667,688	0.31
LiOH84N	\$12,000	t	233	\$2,807,544	0.33
Quicklime	\$300	t	6127	\$2,113,980	0.25
Limestone	\$150	t	28614	\$5,579,686	0.66
Calcrete/Dolomite	\$13	t	0	\$0	0.00
Kerosene	\$500	t	1321	\$785,995	0.09
Raw Water	\$1	Ml	1114137	\$1,120,883	0.12
Flocculant	\$2,150	t	54	\$1,151,771	0.01
Diesel	\$1	L	3923449	\$3,890,380	0.46
<b>Total</b>				<b>\$26,331,076</b>	<b>\$3.10</b>

	Maintenance				
	Mechanical Capital USD	Maintenance %	Cost		USD/t ROM
			USD/a	USD/t ROM	
Crushing	\$116,910,000	5%	\$845,500	\$0.10	
HPGR	\$12,591,000	5%	\$649,550	\$0.08	
Agglomeration and Heap Leaching	\$13,316,000	1%	\$133,160	\$0.02	
Copper SX, EW and Crystallisation	\$24,187,000	3%	\$725,610	\$0.09	
Iron Removal and Tailings	\$2,812,000	3%	\$84,360	\$0.01	
Process and Raw Water	\$1,518,000	1%	\$15,180	\$0.00	
Reagents	\$2,580,200	3%	\$77,706	\$0.01	
Services	\$1,633,000	3%	\$48,990	\$0.01	
<b>Total</b>	<b>\$75,967,200</b>	<b>3.40%</b>	<b>\$2,580,056</b>	<b>\$0.30</b>	

	Plant Standby Cost				
	Assumptions and Bases		% of annual total cost	Standby Cost USD/a	Dist %
Power	Aglators, thickeners and lighting persist		15.0	\$1,286,516	15.7
Consumables	Air and water service costs persist		5.0	\$366,342	4.5
Reagents	No reagent consumption due to no throughput		0.0	\$0	0.0
Labour	All staff retain their positions		100.0	\$4,930,792	60.3
Maintenance	Operational equipment maintenance		15.0	\$387,038	4.7
Miscellaneous	Contract agreements		100.0	\$1,200,000	14.7
<b>Total</b>			<b>16.0</b>	<b>\$8,170,659</b>	<b>100.0</b>

	Power					
	Installed kW	Utilisation %	kW Draw	Total kWh/a	Cost USD/a	USD/t ROM
Crushing	3,666	70	2,566	18,736,517	\$1,327,596	\$0.16
HPGR	4,651	90	4,195	33,073,727	\$2,790,232	\$0.33
Agglomeration and Heap Leaching	2,057	98	2,016	17,308,192	\$1,460,020	\$0.17
Copper SX, EW and Crystallisation	4,420	90	3,978	31,361,975	\$2,645,822	\$0.31
Iron Removal and Tailings	202	90	182	1,434,560	\$121,025	\$0.01
Process and Raw Water	335	90	302	2,378,374	\$200,649	\$0.02
Reagents	30	90	27	215,961	\$18,186	\$0.00
Services	28	70	20	157,007	\$13,246	\$0.00
<b>Total</b>	<b>16,400</b>		<b>13,286</b>	<b>101,663,914</b>	<b>\$8,576,774</b>	<b>\$1.01</b>

	Consumables					
	Unit	Price USD/unit	Consumption (unit/a)	Cost USD/a	Freight USD/a	USD/t ROM
Gyratory Crusher Liner - Mantle	set	\$200,000.00	2	\$400,000	\$36,000	\$0.05
Gyratory Crusher Liner - Concave	set	\$200,000.00	4	\$800,000	\$72,000	\$0.10
Cone Crusher Liners - Bowl	set	\$18,000.00	6	\$108,000	\$9,720	\$0.01
Cone Crusher Liners - Mantle	set	\$18,000.00	6	\$108,000	\$9,720	\$0.01
Secondary Screen	set	\$20,000.00	8	\$160,000	\$14,400	\$0.02
HPGR Liner and Plates	set	\$1,149,512.00	1	\$574,756	\$51,728	\$0.07
HPGR Double Deck Screen Liner	set	\$25,000.00	16	\$400,000	\$36,000	\$0.05
Pad Clearance	m2	\$0.65	150840	\$98,046	\$0.01	
Pad Earthworks	m3	\$2.50	288610	\$671,525	\$0.08	
Pad Liner	m2	\$8.40	150840	\$1,267,056	\$114,035	\$0.16
Irrigation Tubing	m	\$7.00	5384	\$37,688	\$3,392	\$0.00
Replacement Cathodes	set	\$150.00	530	\$79,500	\$7,155	\$0.01
Replacement Anodes	set	\$200.00	663	\$132,600	\$11,825	\$0.02
Copper Sulfate Bags	each	\$12.50	51081	\$638,511	\$57,466	\$0.08
Copper Sulfate Pallets	each	\$15.00	51081	\$766,215	\$68,955	\$0.10
Oil	t	\$900.00	394	\$354,167	\$31,875	\$0.05
Grease	t	\$450.00	394	\$177,083	\$15,938	\$0.02
Air Filters	set	\$3,745.28	1	\$1,873	\$169	\$0.00
Mobile Lighting Tower Parts	set	\$700.00	3	\$2,100	\$189	\$0.00
Light Vehicle Parts	set	\$350.00	6	\$2,100	\$189	\$0.00
Water Truck Parts	set	\$2,100.00	1	\$2,100	\$189	\$0.00
Forklift Parts	set	\$1,750.00	2	\$3,500	\$315	\$0.00
Ambulance Parts/Consumables	set	\$700.00	1	\$700	\$63	\$0.00
<b>Total</b>				<b>\$7,326,841</b>	<b>\$0.86</b>	

Key Inputs and Outputs			
Plant Throughput dry	8,500,000	tpa	
Utilisation (Crushing)	6,132	h/a	
Utilisation (Grinding)	7,884	h/a	
Plant Throughput dry	1,078	dph	
Head Grade	0.310%	% Cu	
Recovery	85	% Cu	
Annual Production	8,967	t Cu	
	19,769,622	lb Cu	
	51,081	t CuSO4.5H2O	
	112,613,875	lb CuSO4.5H2O	
	55,595,856	Total lb Cu Eq	

Power Cost	\$0.084	USD/kWh
Total Power	11.96	kWh/t
Abrasion Index	0.49	
Fixed Component	\$8,170,659	USD/a
Variable Component	\$42,774,881	USD/a
Operating Cost Estimation	\$5.99	USD/t ROM
Operating Cost Estimation	\$0.92	USD/lb Cu Eq

Miscellaneous Costs Only			
	Cost		USD/t ROM
	USD/a	USD/t ROM	
Laboratory Costs	\$1,000,000	\$0.12	
Contractors	\$100,000	\$0.01	
Vehicle Fleet	\$100,000	\$0.01	
<b>Total</b>	<b>\$1,200,000</b>	<b>\$0.14</b>	

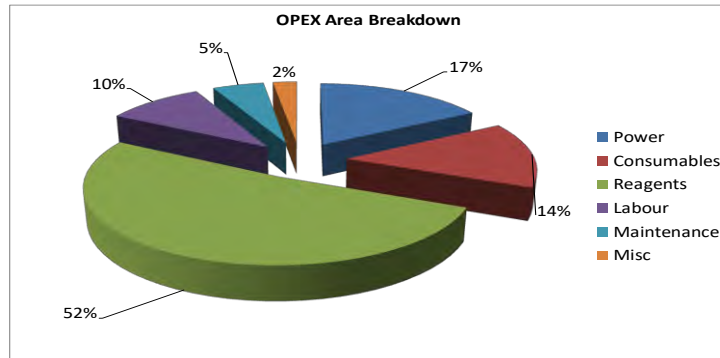

Rev	Date	Engineer	Comments
A	13/03/20	DC	Issue as draft to client
A	6/03/20	LZ	Began populating updated layout

**24.7 Operating Cost – Option 4**

DRAFT

Title: OPEX @ 20 Mtpa @ 80% Cu Recovery + CuSO4  
 Document No.: J5329-ES-CA-000-001  
 Project: Haib PEA  
 Client: Deep-South Resources  
 Date: 21-Apr-20  
 Rev: A  
 Option: Whole Ore Heap Leach  
 Accuracy: ± 30%  
 Comments:

Key Inputs and Outputs		
Plant Throughput dry	20,000,000	tpa
Utilisation (Crushing)	6,132	h/a
Utilisation (Grinding)	7,884	h/a
Plant Throughput dry	2,537	dlph
Head Grade	0.310%	% Cu
Recovery	80	% Cu
Annual Production	35,332	t Cu
	77,894,214	lb Cu
	51,081	t CuSO4.5H2O
	112,613,875	lb CuSO4.5H2O
	113,720,448	Total lb Cu Eq
Power Cost	\$0.084	USD/kWh
Total Power	11.05	MWh/t
Abrasion Index	0.49	
Fixed Component	\$11,237,479	USD/a
Fixed Component	\$0.56	USD/t ROM
Variable Component	\$79,561,810	USD/a
Variable Component	\$3.98	USD/t ROM
<b>Operating Cost Estimation</b>	<b>\$4.54</b>	<b>USD/t ROM</b>
<b>Operating Cost Estimation</b>	<b>\$0.80</b>	<b>USD/lb Cu Eq</b>

Miscellaneous Costs Only		
	Cost USD/a	USD/t ROM
Laboratory Costs	\$1,000,000	\$0.05
Contractors	\$100,000	\$0.01
Vehicle Fleet	\$100,000	\$0.01
<b>Total</b>	<b>\$1,200,000</b>	<b>\$0.06</b>

Summary 1 - Cost per pound of copper produced (Based on Commodity)				
	Cost USD/a	Fixed %	Fixed Cost USD/a	Variable Cost USD/a
Power	\$18,636,581	15.0	\$2,795,487	\$15,841,094
Consumables	\$13,194,092	5.0	\$659,705	\$12,534,388
Reagents	\$47,202,042	0.0	\$0	\$47,202,042
Labour	\$5,879,177	100.0	\$5,879,177	\$0
Maintenance	\$4,687,396	15.0	\$703,109	\$3,984,287
Misc	\$1,200,000	100.0	\$1,200,000	\$0
<b>Total</b>	<b>\$90,799,289</b>	<b>12.4</b>	<b>\$11,237,479</b>	<b>\$79,561,810</b>

Summary 1 - Cost per tonne of Concentrate (Based on Commodity)				
	Cost USD/a	Fixed Cost USD/a	Variable Cost USD/a	Overall Distribution %
Power	\$18,636,581	\$0.93	\$2,795,487	20.5
Consumables	\$13,194,092	\$0.66	\$659,705	14.5
Reagents	\$47,202,042	\$2.36	\$0	52.0
Labour	\$5,879,177	\$0.29	\$5,879,177	6.5
Maintenance	\$4,687,396	\$0.23	\$703,109	\$3,984,287
Miscellaneous	\$1,200,000	\$0.06	\$1,200,000	1.3
<b>Total</b>	<b>\$90,799,289</b>	<b>\$4.54</b>	<b>\$11,237,479</b>	<b>\$79,561,810</b>

Reagents					
	Price USD/unit	Unit	Consumption (unit/a)	Cost USD/a	USD/t ROM
Bulphuric Acid	\$275	t	37607	\$12,034,277	0.60
Polycrylamide	\$2,150	t	2038	\$6,422,349	0.32
LXD84N	\$12,000	t	548	\$6,605,986	0.33
Quicklime	\$300	t	13887	\$4,791,125	0.24
Limestone	\$150	t	46555	\$9,078,250	0.45
Calcium/Dolomite	\$13	t	0	\$0	0.00
Kerosene	\$550	t	3108	\$1,849,164	0.09
Raw Water	\$1	kL	2475430	\$2,268,237	0.11
Flocculant	\$2,150	t	119	\$262,275	0.01
Diesel	\$1	L	3923449	\$3,990,390	0.19
<b>Total</b>				<b>\$47,202,042</b>	<b>\$2.36</b>

Maintenance				
	Mechanical Capital USD	Maintenance %	Cost USD/a	USD/t ROM
Crushing	\$33,812,000	5%	\$1,690,600	\$0.08
HPGR	\$24,532,000	5%	\$1,226,600	\$0.06
Agglomeration and Heap Leaching	\$24,974,000	1%	\$249,740	\$0.01
Copper SX and EW	\$41,819,000	3%	\$1,294,570	\$0.06
Iron Removal and Tailings	\$3,583,000	3%	\$107,490	\$0.01
Process and Raw Water	\$2,357,000	1%	\$23,570	\$0.00
Reagents	\$2,861,200	3%	\$85,836	\$0.00
Services	\$1,633,000	3%	\$48,990	\$0.00
<b>Total</b>	<b>\$135,671,200</b>	<b>3.46%</b>	<b>\$4,687,396</b>	<b>\$0.23</b>

Plant Standby Cost				
	Assumptions and Bases	% of annual total cost	Standby Cost USD/a	Dist %
Power	Aplators, thickeners and lighting persist	15.0	\$2,795,487	24.9
Consumables	Air and water service costs persist	5.0	\$659,705	5.9
Reagents	No reagent consumption due to no throughput	0.0	\$0	0.0
Labour	All staff retain their positions	100.0	\$5,879,177	52.3
Maintenance	Operational equipment maintenance	15.0	\$703,109	6.3
Miscellaneous	Contract agreements	100.0	\$1,200,000	10.7
<b>Total</b>		<b>12.4</b>	<b>\$11,237,479</b>	<b>100.0</b>

Power						
	Installed kW	Utilisation %	kW Draw	Total kWh/a	Cost USD/a	USD/t ROM
Crushing	7,072	70	4,950	30,355,149	\$2,560,882	\$0.13
HPGR	8,607	90	7,746	61,071,929	\$5,152,272	\$0.26
Agglomeration and Heap Leaching	3,803	98	3,727	31,998,898	\$2,699,537	\$0.13
Copper SX and EW	12,917	90	11,625	91,853,407	\$7,732,248	\$0.39
Iron Removal and Tailings	309	90	278	2,192,125	\$184,936	\$0.01
Process and Raw Water	452	90	407	3,209,730	\$270,786	\$0.01
Reagents	38	90	34	268,784	\$22,674	\$0.00
Services	28	70	20	157,007	\$13,246	\$0.00
<b>Total</b>	<b>33,227</b>		<b>28,788</b>	<b>220,906,798</b>	<b>\$18,636,581</b>	<b>\$0.93</b>

Consumables						
	Unit	Price USD/unit	Consumption (unit/a)	Cost USD/a	Freight USD/a	USD/t ROM
Gyratory Crusher Liner - Mantle	set	\$200,000.00	4	\$800,000	\$72,000	\$0.04
Gyratory Crusher Liner - Concave	set	\$200,000.00	8	\$1,600,000	\$144,000	\$0.09
Cone Crusher Liners - Bowl	set	\$18,000.00	12	\$216,000	\$19,440	\$0.01
Cone Crusher Liners - Mantle	set	\$18,000.00	12	\$216,000	\$19,440	\$0.01
Secondary Screen	set	\$20,000.00	8	\$160,000	\$14,400	\$0.01
HPGR Liner and Plates	set	\$1,149,512.00	1	\$1,149,512	\$51,726	\$0.03
HPGR Double Deck Screen Liner	set	\$25,000.00	16	\$400,000	\$36,000	\$0.02
Pad Clearance	m2	\$0.65	354918	\$230,697	\$0.00	\$0.01
Pad Earthworks	m3	\$2.50	632023	\$1,580,058	\$0.08	\$0.08
Pad Liner	m2	\$8.40	354918	\$2,981,312	\$268,318	\$0.16
Irrigation Tubing	m	\$7.00	5384	\$37,685	\$3,392	\$0.00
Replacement Cathodes	set	\$150.00	2259	\$338,820	\$30,494	\$0.02
Replacement Anodes	set	\$200.00	2259	\$451,760	\$40,658	\$0.02
Copper Sulfate Bags	each	\$12.50	51081	\$638,511	\$57,466	\$0.03
Copper Sulfate Pallets	each	\$15.00	51081	\$766,213	\$68,959	\$0.04
Oil	t	\$900.00	926	\$833,333	\$75,000	\$0.05
Grease	t	\$450.00	926	\$416,667	\$37,500	\$0.02
Air Filters	set	\$3,745.28	1	\$11,673	\$169	\$0.00
Mobile Lighting Tower Parts	set	\$700.00	3	\$2,100	\$189	\$0.00
Light Vehicle Parts	set	\$350.00	6	\$2,100	\$189	\$0.00
Water Truck Parts	set	\$2,100.00	1	\$2,100	\$189	\$0.00
Forklift Parts	set	\$1,750.00	2	\$3,500	\$315	\$0.00
Ambulance Parts/Consumables	set	\$700.00	1	\$700	\$63	\$0.00
<b>Total</b>				<b>\$13,194,092</b>	<b>\$0.66</b>	

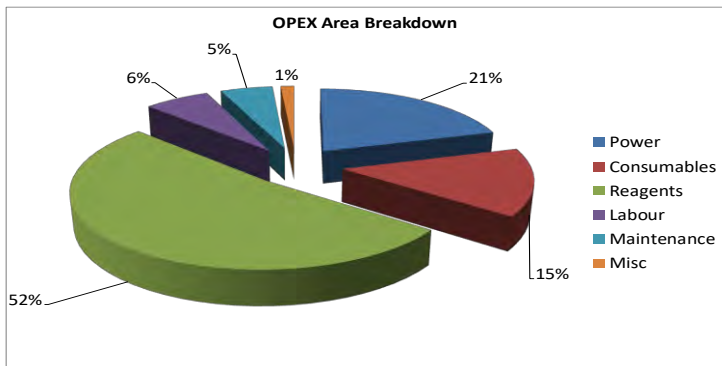

Rev	Date	Engineer	Comments
A	21/04/20	DC	Issue as draft to client
A	30/4/20	BM	Began populating updated layout

# 24.8 Operating Cost – Option 5

<p>Title: <b>OPEX-20 Mtpa @ 85% Cu Recovery</b>                  Document No.: <b>J5329-ES-CA-000-001</b>                  Project: <b>Haib PEA</b>                  Client: <b>Deep-South Resources</b>                  Date: <b>13-Mar-20</b>                  Rev: <b>A</b>                  Option: <b>Whole Ore Heap Leach</b>                  Accuracy: <b>± 30%</b>                  Comments:</p>		<p><b>Summary 1 - Cost per pound of copper produced (Based on Commodity)</b></p> <table border="1"> <thead> <tr> <th rowspan="2"></th> <th colspan="2">Cost</th> <th rowspan="2">Fixed %</th> <th rowspan="2">Fixed Cost USD/a</th> <th rowspan="2">Variable Cost USD/a</th> </tr> <tr> <th>USD/a</th> <th>USD/lb Cu Eq</th> </tr> </thead> <tbody> <tr> <td>Power</td> <td>\$21,120,584</td> <td>\$0.19</td> <td>15.0</td> <td>\$3,168,088</td> <td>\$17,952,497</td> </tr> <tr> <td>Consumables</td> <td>\$12,086,191</td> <td>\$0.11</td> <td>5.0</td> <td>\$604,310</td> <td>\$11,481,881</td> </tr> <tr> <td>Reagents</td> <td>\$42,097,076</td> <td>\$0.37</td> <td>0.0</td> <td>\$0</td> <td>\$42,097,076</td> </tr> <tr> <td>Labour</td> <td>\$5,879,177</td> <td>\$0.05</td> <td>100.0</td> <td>\$5,879,177</td> <td>\$0</td> </tr> <tr> <td>Maintenance</td> <td>\$4,671,446</td> <td>\$0.04</td> <td>15.0</td> <td>\$700,717</td> <td>\$3,970,729</td> </tr> <tr> <td>Misc</td> <td>\$1,200,000</td> <td>\$0.01</td> <td>100.0</td> <td>\$1,200,000</td> <td>\$0</td> </tr> <tr> <td><b>Total</b></td> <td><b>\$87,054,476</b></td> <td><b>\$0.77</b></td> <td><b>13.3</b></td> <td><b>\$11,562,292</b></td> <td><b>\$75,502,183</b></td> </tr> </tbody> </table>							Cost		Fixed %	Fixed Cost USD/a	Variable Cost USD/a	USD/a	USD/lb Cu Eq	Power	\$21,120,584	\$0.19	15.0	\$3,168,088	\$17,952,497	Consumables	\$12,086,191	\$0.11	5.0	\$604,310	\$11,481,881	Reagents	\$42,097,076	\$0.37	0.0	\$0	\$42,097,076	Labour	\$5,879,177	\$0.05	100.0	\$5,879,177	\$0	Maintenance	\$4,671,446	\$0.04	15.0	\$700,717	\$3,970,729	Misc	\$1,200,000	\$0.01	100.0	\$1,200,000	\$0	<b>Total</b>	<b>\$87,054,476</b>	<b>\$0.77</b>	<b>13.3</b>	<b>\$11,562,292</b>	<b>\$75,502,183</b>	<p><b>Plant Standby Cost</b></p> <table border="1"> <thead> <tr> <th rowspan="2"></th> <th rowspan="2">Assumptions and Bases</th> <th rowspan="2">% of annual total cost</th> <th rowspan="2">Standby Cost USD/a</th> <th rowspan="2">Dist %</th> </tr> </thead> <tbody> <tr> <td>Power</td> <td>Agitators, thickeners and lighting persist</td> <td>15.0</td> <td>\$3,168,088</td> <td>27.4</td> </tr> <tr> <td>Consumables</td> <td>Air and water service costs persist</td> <td>5.0</td> <td>\$604,310</td> <td>5.2</td> </tr> <tr> <td>Reagents</td> <td>No reagent consumption due to no throughput</td> <td>0.0</td> <td>\$0</td> <td>0.0</td> </tr> <tr> <td>Labour</td> <td>All staff retain their positions</td> <td>100.0</td> <td>\$5,879,177</td> <td>50.9</td> </tr> <tr> <td>Maintenance</td> <td>Operational equipment maintenance</td> <td>15.0</td> <td>\$700,717</td> <td>6.1</td> </tr> <tr> <td>Miscellaneous</td> <td>Contract agreements</td> <td>100.0</td> <td>\$1,200,000</td> <td>10.4</td> </tr> <tr> <td><b>Total</b></td> <td></td> <td><b>13.3</b></td> <td><b>\$11,562,292</b></td> <td><b>100.0</b></td> </tr> </tbody> </table>							Assumptions and Bases	% of annual total cost	Standby Cost USD/a	Dist %	Power	Agitators, thickeners and lighting persist	15.0	\$3,168,088	27.4	Consumables	Air and water service costs persist	5.0	\$604,310	5.2	Reagents	No reagent consumption due to no throughput	0.0	\$0	0.0	Labour	All staff retain their positions	100.0	\$5,879,177	50.9	Maintenance	Operational equipment maintenance	15.0	\$700,717	6.1	Miscellaneous	Contract agreements	100.0	\$1,200,000	10.4	<b>Total</b>		<b>13.3</b>	<b>\$11,562,292</b>	<b>100.0</b>																																																																																																																					
	Cost		Fixed %	Fixed Cost USD/a	Variable Cost USD/a																																																																																																																																																																																																																							
	USD/a	USD/lb Cu Eq																																																																																																																																																																																																																										
Power	\$21,120,584	\$0.19	15.0	\$3,168,088	\$17,952,497																																																																																																																																																																																																																							
Consumables	\$12,086,191	\$0.11	5.0	\$604,310	\$11,481,881																																																																																																																																																																																																																							
Reagents	\$42,097,076	\$0.37	0.0	\$0	\$42,097,076																																																																																																																																																																																																																							
Labour	\$5,879,177	\$0.05	100.0	\$5,879,177	\$0																																																																																																																																																																																																																							
Maintenance	\$4,671,446	\$0.04	15.0	\$700,717	\$3,970,729																																																																																																																																																																																																																							
Misc	\$1,200,000	\$0.01	100.0	\$1,200,000	\$0																																																																																																																																																																																																																							
<b>Total</b>	<b>\$87,054,476</b>	<b>\$0.77</b>	<b>13.3</b>	<b>\$11,562,292</b>	<b>\$75,502,183</b>																																																																																																																																																																																																																							
	Assumptions and Bases	% of annual total cost	Standby Cost USD/a	Dist %																																																																																																																																																																																																																								
					Power	Agitators, thickeners and lighting persist	15.0	\$3,168,088	27.4																																																																																																																																																																																																																			
Consumables	Air and water service costs persist	5.0	\$604,310	5.2																																																																																																																																																																																																																								
Reagents	No reagent consumption due to no throughput	0.0	\$0	0.0																																																																																																																																																																																																																								
Labour	All staff retain their positions	100.0	\$5,879,177	50.9																																																																																																																																																																																																																								
Maintenance	Operational equipment maintenance	15.0	\$700,717	6.1																																																																																																																																																																																																																								
Miscellaneous	Contract agreements	100.0	\$1,200,000	10.4																																																																																																																																																																																																																								
<b>Total</b>		<b>13.3</b>	<b>\$11,562,292</b>	<b>100.0</b>																																																																																																																																																																																																																								
<p><b>Key Inputs and Outputs</b></p> <table border="1"> <thead> <tr> <th></th> <th></th> <th></th> <th></th> </tr> </thead> <tbody> <tr> <td>Plant Throughput dry</td> <td>20,000,000</td> <td>tpa</td> <td></td> </tr> <tr> <td>Utilisation (Crushing)</td> <td>6.132</td> <td>n/a</td> <td></td> </tr> <tr> <td>Utilisation (Grinding)</td> <td>7.884</td> <td>n/a</td> <td></td> </tr> <tr> <td>Plant Throughput dry</td> <td>2,537</td> <td>dph</td> <td></td> </tr> <tr> <td>Head Grade</td> <td>0.310%</td> <td>% Cu</td> <td></td> </tr> <tr> <td>Recovery</td> <td>84.9</td> <td>% Cu</td> <td></td> </tr> <tr> <td>Annual Production</td> <td>51,077</td> <td>t Cu</td> <td></td> </tr> <tr> <td></td> <td>112,606,047</td> <td>lb Cu</td> <td></td> </tr> <tr> <td>Power Cost</td> <td>\$0.084</td> <td>USD/kWh</td> <td></td> </tr> <tr> <td>Total Power</td> <td>12.62</td> <td>kWh/t</td> <td></td> </tr> <tr> <td>Abrasion Index</td> <td>0.49</td> <td></td> <td></td> </tr> <tr> <td>Fixed Component</td> <td>\$11,562,292</td> <td>USD/a</td> <td></td> </tr> <tr> <td>Fixed Component</td> <td>\$0.58</td> <td>USD/a ROM</td> <td></td> </tr> <tr> <td>Variable Component</td> <td>\$75,502,183</td> <td>USD/a</td> <td></td> </tr> <tr> <td>Variable Component</td> <td>\$3.78</td> <td>USD/a ROM</td> <td></td> </tr> <tr> <td>Operating Cost Estimation</td> <td>\$4.35</td> <td>USD/a ROM</td> <td></td> </tr> <tr> <td>Operating Cost Estimation</td> <td>\$0.77</td> <td>USD/lb Cu Eq</td> <td></td> </tr> </tbody> </table>						Plant Throughput dry	20,000,000	tpa		Utilisation (Crushing)	6.132	n/a		Utilisation (Grinding)	7.884	n/a		Plant Throughput dry	2,537	dph		Head Grade	0.310%	% Cu		Recovery	84.9	% Cu		Annual Production	51,077	t Cu			112,606,047	lb Cu		Power Cost	\$0.084	USD/kWh		Total Power	12.62	kWh/t		Abrasion Index	0.49			Fixed Component	\$11,562,292	USD/a		Fixed Component	\$0.58	USD/a ROM		Variable Component	\$75,502,183	USD/a		Variable Component	\$3.78	USD/a ROM		Operating Cost Estimation	\$4.35	USD/a ROM		Operating Cost Estimation	\$0.77	USD/lb Cu Eq		<p><b>Summary 1 - Cost per tonne of Concentrate (Based on Commodity)</b></p> <table border="1"> <thead> <tr> <th rowspan="2"></th> <th colspan="2">Cost</th> <th rowspan="2">Fixed Cost USD/a</th> <th rowspan="2">Variable Cost USD/a</th> <th rowspan="2">Overall Distribution %</th> </tr> <tr> <th>USD/a</th> <th>USD/t ROM</th> </tr> </thead> <tbody> <tr> <td>Power</td> <td>\$21,120,584</td> <td>\$1.06</td> <td>\$3,168,088</td> <td>\$17,952,497</td> <td>24.3</td> </tr> <tr> <td>Consumables</td> <td>\$12,086,191</td> <td>\$0.60</td> <td>\$604,310</td> <td>\$11,481,881</td> <td>13.9</td> </tr> <tr> <td>Reagents</td> <td>\$42,097,076</td> <td>\$2.10</td> <td>\$0</td> <td>\$42,097,076</td> <td>48.4</td> </tr> <tr> <td>Labour</td> <td>\$5,879,177</td> <td>\$0.29</td> <td>\$5,879,177</td> <td>\$0</td> <td>6.8</td> </tr> <tr> <td>Maintenance</td> <td>\$4,671,446</td> <td>\$0.23</td> <td>\$700,717</td> <td>\$3,970,729</td> <td>5.4</td> </tr> <tr> <td>Miscellaneous</td> <td>\$1,200,000</td> <td>\$0.06</td> <td>\$1,200,000</td> <td>\$0</td> <td>1.4</td> </tr> <tr> <td><b>Total</b></td> <td><b>\$87,054,476</b></td> <td><b>\$4.35</b></td> <td><b>\$11,562,292</b></td> <td><b>\$75,502,183</b></td> <td><b>100.0</b></td> </tr> </tbody> </table>							Cost		Fixed Cost USD/a	Variable Cost USD/a	Overall Distribution %	USD/a	USD/t ROM	Power	\$21,120,584	\$1.06	\$3,168,088	\$17,952,497	24.3	Consumables	\$12,086,191	\$0.60	\$604,310	\$11,481,881	13.9	Reagents	\$42,097,076	\$2.10	\$0	\$42,097,076	48.4	Labour	\$5,879,177	\$0.29	\$5,879,177	\$0	6.8	Maintenance	\$4,671,446	\$0.23	\$700,717	\$3,970,729	5.4	Miscellaneous	\$1,200,000	\$0.06	\$1,200,000	\$0	1.4	<b>Total</b>	<b>\$87,054,476</b>	<b>\$4.35</b>	<b>\$11,562,292</b>	<b>\$75,502,183</b>	<b>100.0</b>																																																																																											
Plant Throughput dry	20,000,000	tpa																																																																																																																																																																																																																										
Utilisation (Crushing)	6.132	n/a																																																																																																																																																																																																																										
Utilisation (Grinding)	7.884	n/a																																																																																																																																																																																																																										
Plant Throughput dry	2,537	dph																																																																																																																																																																																																																										
Head Grade	0.310%	% Cu																																																																																																																																																																																																																										
Recovery	84.9	% Cu																																																																																																																																																																																																																										
Annual Production	51,077	t Cu																																																																																																																																																																																																																										
	112,606,047	lb Cu																																																																																																																																																																																																																										
Power Cost	\$0.084	USD/kWh																																																																																																																																																																																																																										
Total Power	12.62	kWh/t																																																																																																																																																																																																																										
Abrasion Index	0.49																																																																																																																																																																																																																											
Fixed Component	\$11,562,292	USD/a																																																																																																																																																																																																																										
Fixed Component	\$0.58	USD/a ROM																																																																																																																																																																																																																										
Variable Component	\$75,502,183	USD/a																																																																																																																																																																																																																										
Variable Component	\$3.78	USD/a ROM																																																																																																																																																																																																																										
Operating Cost Estimation	\$4.35	USD/a ROM																																																																																																																																																																																																																										
Operating Cost Estimation	\$0.77	USD/lb Cu Eq																																																																																																																																																																																																																										
	Cost		Fixed Cost USD/a	Variable Cost USD/a	Overall Distribution %																																																																																																																																																																																																																							
	USD/a	USD/t ROM																																																																																																																																																																																																																										
Power	\$21,120,584	\$1.06	\$3,168,088	\$17,952,497	24.3																																																																																																																																																																																																																							
Consumables	\$12,086,191	\$0.60	\$604,310	\$11,481,881	13.9																																																																																																																																																																																																																							
Reagents	\$42,097,076	\$2.10	\$0	\$42,097,076	48.4																																																																																																																																																																																																																							
Labour	\$5,879,177	\$0.29	\$5,879,177	\$0	6.8																																																																																																																																																																																																																							
Maintenance	\$4,671,446	\$0.23	\$700,717	\$3,970,729	5.4																																																																																																																																																																																																																							
Miscellaneous	\$1,200,000	\$0.06	\$1,200,000	\$0	1.4																																																																																																																																																																																																																							
<b>Total</b>	<b>\$87,054,476</b>	<b>\$4.35</b>	<b>\$11,562,292</b>	<b>\$75,502,183</b>	<b>100.0</b>																																																																																																																																																																																																																							
<p><b>Miscellaneous Costs Only</b></p> <table border="1"> <thead> <tr> <th></th> <th>Cost USD/a</th> <th>USD/t ROM</th> </tr> </thead> <tbody> <tr> <td>Laboratory Costs</td> <td>\$1,000,000</td> <td>\$0.05</td> </tr> <tr> <td>Contractors</td> <td>\$100,000</td> <td>\$0.01</td> </tr> <tr> <td>Vehicle Fleet</td> <td>\$100,000</td> <td>\$0.01</td> </tr> <tr> <td><b>Total</b></td> <td><b>\$1,200,000</b></td> <td><b>\$0.06</b></td> </tr> </tbody> </table>			Cost USD/a	USD/t ROM	Laboratory Costs	\$1,000,000	\$0.05	Contractors	\$100,000	\$0.01	Vehicle Fleet	\$100,000	\$0.01	<b>Total</b>	<b>\$1,200,000</b>	<b>\$0.06</b>	<p><b>Reagents</b></p> <table border="1"> <thead> <tr> <th rowspan="2"></th> <th rowspan="2">Price USD/unit</th> <th rowspan="2">Unit</th> <th rowspan="2">Consumption (unit/a)</th> <th colspan="2">Cost</th> </tr> <tr> <th>USD/a</th> <th>USD/t ROM</th> </tr> </thead> <tbody> <tr> <td>Sulphuric Acid</td> <td>\$275</td> <td>t</td> <td>18926</td> <td>\$6,056,391</td> <td>0.30</td> </tr> <tr> <td>Polycrylamide</td> <td>\$2,150</td> <td>t</td> <td>2033</td> <td>\$6,437,902</td> <td>0.32</td> </tr> <tr> <td>Limekiln</td> <td>\$12,000</td> <td>t</td> <td>548</td> <td>\$6,605,986</td> <td>0.33</td> </tr> <tr> <td>Quicklime</td> <td>\$300</td> <td>t</td> <td>14418</td> <td>\$4,974,071</td> <td>0.25</td> </tr> <tr> <td>Limestone</td> <td>\$150</td> <td>t</td> <td>67327</td> <td>\$13,128,672</td> <td>0.66</td> </tr> <tr> <td>Calcium/Dolomite</td> <td>\$13</td> <td>t</td> <td>0</td> <td>\$0</td> <td>0.00</td> </tr> <tr> <td>Kerosene</td> <td>\$550</td> <td>t</td> <td>3108</td> <td>\$1,849,164</td> <td>0.09</td> </tr> <tr> <td>Raw Water</td> <td>\$1</td> <td>kL</td> <td>2370234</td> <td>\$2,171,845</td> <td>0.11</td> </tr> <tr> <td>Flocculant</td> <td>\$2,150</td> <td>t</td> <td>127</td> <td>\$278,103</td> <td>0.01</td> </tr> <tr> <td>Diesel</td> <td>\$1</td> <td>L</td> <td>600000</td> <td>\$594,943</td> <td>0.03</td> </tr> <tr> <td><b>Total</b></td> <td></td> <td></td> <td></td> <td><b>\$42,097,076</b></td> <td><b>\$2.10</b></td> </tr> </tbody> </table>							Price USD/unit	Unit	Consumption (unit/a)	Cost		USD/a	USD/t ROM	Sulphuric Acid	\$275	t	18926	\$6,056,391	0.30	Polycrylamide	\$2,150	t	2033	\$6,437,902	0.32	Limekiln	\$12,000	t	548	\$6,605,986	0.33	Quicklime	\$300	t	14418	\$4,974,071	0.25	Limestone	\$150	t	67327	\$13,128,672	0.66	Calcium/Dolomite	\$13	t	0	\$0	0.00	Kerosene	\$550	t	3108	\$1,849,164	0.09	Raw Water	\$1	kL	2370234	\$2,171,845	0.11	Flocculant	\$2,150	t	127	\$278,103	0.01	Diesel	\$1	L	600000	\$594,943	0.03	<b>Total</b>				<b>\$42,097,076</b>	<b>\$2.10</b>																																																																																																																												
	Cost USD/a	USD/t ROM																																																																																																																																																																																																																										
Laboratory Costs	\$1,000,000	\$0.05																																																																																																																																																																																																																										
Contractors	\$100,000	\$0.01																																																																																																																																																																																																																										
Vehicle Fleet	\$100,000	\$0.01																																																																																																																																																																																																																										
<b>Total</b>	<b>\$1,200,000</b>	<b>\$0.06</b>																																																																																																																																																																																																																										
	Price USD/unit	Unit	Consumption (unit/a)	Cost																																																																																																																																																																																																																								
				USD/a	USD/t ROM																																																																																																																																																																																																																							
Sulphuric Acid	\$275	t	18926	\$6,056,391	0.30																																																																																																																																																																																																																							
Polycrylamide	\$2,150	t	2033	\$6,437,902	0.32																																																																																																																																																																																																																							
Limekiln	\$12,000	t	548	\$6,605,986	0.33																																																																																																																																																																																																																							
Quicklime	\$300	t	14418	\$4,974,071	0.25																																																																																																																																																																																																																							
Limestone	\$150	t	67327	\$13,128,672	0.66																																																																																																																																																																																																																							
Calcium/Dolomite	\$13	t	0	\$0	0.00																																																																																																																																																																																																																							
Kerosene	\$550	t	3108	\$1,849,164	0.09																																																																																																																																																																																																																							
Raw Water	\$1	kL	2370234	\$2,171,845	0.11																																																																																																																																																																																																																							
Flocculant	\$2,150	t	127	\$278,103	0.01																																																																																																																																																																																																																							
Diesel	\$1	L	600000	\$594,943	0.03																																																																																																																																																																																																																							
<b>Total</b>				<b>\$42,097,076</b>	<b>\$2.10</b>																																																																																																																																																																																																																							
<p><b>Maintenance</b></p> <table border="1"> <thead> <tr> <th rowspan="2"></th> <th rowspan="2">Mechanical Capital USD</th> <th rowspan="2">Maintenance %</th> <th colspan="2">Cost</th> </tr> <tr> <th>USD/a</th> <th>USD/t ROM</th> </tr> </thead> <tbody> <tr> <td>Crushing</td> <td>\$33,812,000</td> <td>5%</td> <td>\$1,690,600</td> <td>\$0.08</td> </tr> <tr> <td>HPGR</td> <td>\$24,532,000</td> <td>5%</td> <td>\$1,226,600</td> <td>\$0.06</td> </tr> <tr> <td>Agglomeration and Heap Leaching</td> <td>\$25,949,000</td> <td>1%</td> <td>\$259,490</td> <td>\$0.01</td> </tr> <tr> <td>Copper SX and EW</td> <td>\$1,326,000</td> <td>3%</td> <td>\$1,239,780</td> <td>\$0.06</td> </tr> <tr> <td>Iron Removal and Tailings</td> <td>\$3,613,000</td> <td>3%</td> <td>\$108,390</td> <td>\$0.01</td> </tr> <tr> <td>Process and Raw Water</td> <td>\$2,343,000</td> <td>1%</td> <td>\$23,430</td> <td>\$0.00</td> </tr> <tr> <td>Reagents</td> <td>\$2,772,200</td> <td>3%</td> <td>\$83,166</td> <td>\$0.00</td> </tr> <tr> <td>Services</td> <td>\$1,633,000</td> <td>3%</td> <td>\$48,990</td> <td>\$0.00</td> </tr> <tr> <td><b>Total</b></td> <td><b>\$135,080,200</b></td> <td><b>3.46%</b></td> <td><b>\$4,671,446</b></td> <td><b>\$0.23</b></td> </tr> </tbody> </table>			Mechanical Capital USD	Maintenance %	Cost		USD/a	USD/t ROM	Crushing	\$33,812,000	5%	\$1,690,600	\$0.08	HPGR	\$24,532,000	5%	\$1,226,600	\$0.06	Agglomeration and Heap Leaching	\$25,949,000	1%	\$259,490	\$0.01	Copper SX and EW	\$1,326,000	3%	\$1,239,780	\$0.06	Iron Removal and Tailings	\$3,613,000	3%	\$108,390	\$0.01	Process and Raw Water	\$2,343,000	1%	\$23,430	\$0.00	Reagents	\$2,772,200	3%	\$83,166	\$0.00	Services	\$1,633,000	3%	\$48,990	\$0.00	<b>Total</b>	<b>\$135,080,200</b>	<b>3.46%</b>	<b>\$4,671,446</b>	<b>\$0.23</b>	<p><b>Consumables</b></p> <table border="1"> <thead> <tr> <th rowspan="2"></th> <th rowspan="2">Unit</th> <th rowspan="2">Price USD/unit</th> <th rowspan="2">Consumption (unit/a)</th> <th colspan="2">Cost</th> <th rowspan="2">Freight</th> <th rowspan="2">USD/t ROM</th> </tr> <tr> <th>USD/a</th> <th>USD/a</th> </tr> </thead> <tbody> <tr> <td>Gyratory Crusher Liner - Mantle</td> <td>set</td> <td>\$200,000.00</td> <td>4</td> <td>\$800,000</td> <td>\$72,000</td> <td>\$0.04</td> </tr> <tr> <td>Gyratory Crusher Liner - Concave</td> <td>set</td> <td>\$200,000.00</td> <td>8</td> <td>\$1,600,000</td> <td>\$144,000</td> <td>\$0.09</td> </tr> <tr> <td>Cone Crusher Liners - Bowl</td> <td>set</td> <td>\$18,000.00</td> <td>12</td> <td>\$216,000</td> <td>\$19,440</td> <td>\$0.01</td> </tr> <tr> <td>Cone Crusher Liners - Mantle</td> <td>set</td> <td>\$18,000.00</td> <td>12</td> <td>\$216,000</td> <td>\$19,440</td> <td>\$0.01</td> </tr> <tr> <td>Secondary Screen</td> <td>set</td> <td>\$20,000.00</td> <td>8</td> <td>\$160,000</td> <td>\$14,400</td> <td>\$0.01</td> </tr> <tr> <td>HPGR Liner and Plates</td> <td>set</td> <td>\$1,149,612.00</td> <td>1</td> <td>\$1,149,612</td> <td>\$51,728</td> <td>\$0.03</td> </tr> <tr> <td>HPGR Double Deck Screen Liner</td> <td>set</td> <td>\$25,000.00</td> <td>16</td> <td>\$400,000</td> <td>\$36,000</td> <td>\$0.02</td> </tr> <tr> <td>Pad Clearance</td> <td>m2</td> <td>\$0.65</td> <td>354918</td> <td>\$230,697</td> <td>\$0.01</td> </tr> <tr> <td>Pad Leveling</td> <td>m3</td> <td>\$2.50</td> <td>632023</td> <td>\$1,580,058</td> <td>\$0.08</td> </tr> <tr> <td>Pad Liner</td> <td>m2</td> <td>\$8.40</td> <td>354918</td> <td>\$2,981,312</td> <td>\$268,318</td> <td>\$0.16</td> </tr> <tr> <td>Irrigation Tubing</td> <td>m</td> <td>\$7.00</td> <td>3584</td> <td>\$25,168</td> <td>\$3,352</td> <td>\$0.02</td> </tr> <tr> <td>Cathode</td> <td>set</td> <td>\$195,000.00</td> <td>2947</td> <td>\$442,080</td> <td>\$39,787</td> <td>\$0.02</td> </tr> <tr> <td>Anode</td> <td>set</td> <td>\$200,000.00</td> <td>3684</td> <td>\$736,800</td> <td>\$66,312</td> <td>\$0.04</td> </tr> <tr> <td>Oil</td> <td>t</td> <td>\$900.00</td> <td>926</td> <td>\$833,333</td> <td>\$75,000</td> <td>\$0.05</td> </tr> <tr> <td>Grease</td> <td>t</td> <td>\$450.00</td> <td>926</td> <td>\$416,667</td> <td>\$37,500</td> <td>\$0.02</td> </tr> <tr> <td>Air Filters</td> <td>set</td> <td>\$3,745.28</td> <td>1</td> <td>\$1,873</td> <td>\$169</td> <td>\$0.00</td> </tr> <tr> <td>Mobile Lighting Tower Parts</td> <td>set</td> <td>\$700.00</td> <td>3</td> <td>\$2,100</td> <td>\$189</td> <td>\$0.00</td> </tr> <tr> <td>Light Vehicle Parts</td> <td>set</td> <td>\$350.00</td> <td>6</td> <td>\$2,100</td> <td>\$189</td> <td>\$0.00</td> </tr> <tr> <td>Water Truck Parts</td> <td>set</td> <td>\$2,100.00</td> <td>1</td> <td>\$2,100</td> <td>\$189</td> <td>\$0.00</td> </tr> <tr> <td>Forklift Parts</td> <td>set</td> <td>\$1,750.00</td> <td>2</td> <td>\$3,500</td> <td>\$315</td> <td>\$0.00</td> </tr> <tr> <td>Ambulance Parts/Consumables</td> <td>set</td> <td>\$700.00</td> <td>1</td> <td>\$700</td> <td>\$63</td> <td>\$0.00</td> </tr> <tr> <td><b>Total</b></td> <td></td> <td></td> <td></td> <td><b>\$12,086,191</b></td> <td><b>\$0.60</b></td> </tr> </tbody> </table>							Unit	Price USD/unit	Consumption (unit/a)	Cost		Freight	USD/t ROM	USD/a	USD/a	Gyratory Crusher Liner - Mantle	set	\$200,000.00	4	\$800,000	\$72,000	\$0.04	Gyratory Crusher Liner - Concave	set	\$200,000.00	8	\$1,600,000	\$144,000	\$0.09	Cone Crusher Liners - Bowl	set	\$18,000.00	12	\$216,000	\$19,440	\$0.01	Cone Crusher Liners - Mantle	set	\$18,000.00	12	\$216,000	\$19,440	\$0.01	Secondary Screen	set	\$20,000.00	8	\$160,000	\$14,400	\$0.01	HPGR Liner and Plates	set	\$1,149,612.00	1	\$1,149,612	\$51,728	\$0.03	HPGR Double Deck Screen Liner	set	\$25,000.00	16	\$400,000	\$36,000	\$0.02	Pad Clearance	m2	\$0.65	354918	\$230,697	\$0.01	Pad Leveling	m3	\$2.50	632023	\$1,580,058	\$0.08	Pad Liner	m2	\$8.40	354918	\$2,981,312	\$268,318	\$0.16	Irrigation Tubing	m	\$7.00	3584	\$25,168	\$3,352	\$0.02	Cathode	set	\$195,000.00	2947	\$442,080	\$39,787	\$0.02	Anode	set	\$200,000.00	3684	\$736,800	\$66,312	\$0.04	Oil	t	\$900.00	926	\$833,333	\$75,000	\$0.05	Grease	t	\$450.00	926	\$416,667	\$37,500	\$0.02	Air Filters	set	\$3,745.28	1	\$1,873	\$169	\$0.00	Mobile Lighting Tower Parts	set	\$700.00	3	\$2,100	\$189	\$0.00	Light Vehicle Parts	set	\$350.00	6	\$2,100	\$189	\$0.00	Water Truck Parts	set	\$2,100.00	1	\$2,100	\$189	\$0.00	Forklift Parts	set	\$1,750.00	2	\$3,500	\$315	\$0.00	Ambulance Parts/Consumables	set	\$700.00	1	\$700	\$63	\$0.00	<b>Total</b>				<b>\$12,086,191</b>	<b>\$0.60</b>
	Mechanical Capital USD				Maintenance %	Cost																																																																																																																																																																																																																						
		USD/a	USD/t ROM																																																																																																																																																																																																																									
Crushing	\$33,812,000	5%	\$1,690,600	\$0.08																																																																																																																																																																																																																								
HPGR	\$24,532,000	5%	\$1,226,600	\$0.06																																																																																																																																																																																																																								
Agglomeration and Heap Leaching	\$25,949,000	1%	\$259,490	\$0.01																																																																																																																																																																																																																								
Copper SX and EW	\$1,326,000	3%	\$1,239,780	\$0.06																																																																																																																																																																																																																								
Iron Removal and Tailings	\$3,613,000	3%	\$108,390	\$0.01																																																																																																																																																																																																																								
Process and Raw Water	\$2,343,000	1%	\$23,430	\$0.00																																																																																																																																																																																																																								
Reagents	\$2,772,200	3%	\$83,166	\$0.00																																																																																																																																																																																																																								
Services	\$1,633,000	3%	\$48,990	\$0.00																																																																																																																																																																																																																								
<b>Total</b>	<b>\$135,080,200</b>	<b>3.46%</b>	<b>\$4,671,446</b>	<b>\$0.23</b>																																																																																																																																																																																																																								
	Unit	Price USD/unit	Consumption (unit/a)	Cost		Freight	USD/t ROM																																																																																																																																																																																																																					
				USD/a	USD/a																																																																																																																																																																																																																							
Gyratory Crusher Liner - Mantle	set	\$200,000.00	4	\$800,000	\$72,000	\$0.04																																																																																																																																																																																																																						
Gyratory Crusher Liner - Concave	set	\$200,000.00	8	\$1,600,000	\$144,000	\$0.09																																																																																																																																																																																																																						
Cone Crusher Liners - Bowl	set	\$18,000.00	12	\$216,000	\$19,440	\$0.01																																																																																																																																																																																																																						
Cone Crusher Liners - Mantle	set	\$18,000.00	12	\$216,000	\$19,440	\$0.01																																																																																																																																																																																																																						
Secondary Screen	set	\$20,000.00	8	\$160,000	\$14,400	\$0.01																																																																																																																																																																																																																						
HPGR Liner and Plates	set	\$1,149,612.00	1	\$1,149,612	\$51,728	\$0.03																																																																																																																																																																																																																						
HPGR Double Deck Screen Liner	set	\$25,000.00	16	\$400,000	\$36,000	\$0.02																																																																																																																																																																																																																						
Pad Clearance	m2	\$0.65	354918	\$230,697	\$0.01																																																																																																																																																																																																																							
Pad Leveling	m3	\$2.50	632023	\$1,580,058	\$0.08																																																																																																																																																																																																																							
Pad Liner	m2	\$8.40	354918	\$2,981,312	\$268,318	\$0.16																																																																																																																																																																																																																						
Irrigation Tubing	m	\$7.00	3584	\$25,168	\$3,352	\$0.02																																																																																																																																																																																																																						
Cathode	set	\$195,000.00	2947	\$442,080	\$39,787	\$0.02																																																																																																																																																																																																																						
Anode	set	\$200,000.00	3684	\$736,800	\$66,312	\$0.04																																																																																																																																																																																																																						
Oil	t	\$900.00	926	\$833,333	\$75,000	\$0.05																																																																																																																																																																																																																						
Grease	t	\$450.00	926	\$416,667	\$37,500	\$0.02																																																																																																																																																																																																																						
Air Filters	set	\$3,745.28	1	\$1,873	\$169	\$0.00																																																																																																																																																																																																																						
Mobile Lighting Tower Parts	set	\$700.00	3	\$2,100	\$189	\$0.00																																																																																																																																																																																																																						
Light Vehicle Parts	set	\$350.00	6	\$2,100	\$189	\$0.00																																																																																																																																																																																																																						
Water Truck Parts	set	\$2,100.00	1	\$2,100	\$189	\$0.00																																																																																																																																																																																																																						
Forklift Parts	set	\$1,750.00	2	\$3,500	\$315	\$0.00																																																																																																																																																																																																																						
Ambulance Parts/Consumables	set	\$700.00	1	\$700	\$63	\$0.00																																																																																																																																																																																																																						
<b>Total</b>				<b>\$12,086,191</b>	<b>\$0.60</b>																																																																																																																																																																																																																							
<p><b>OPEX Area Breakdown</b></p>		<table border="1"> <thead> <tr> <th>Rev</th> <th>Date</th> <th>Engineer</th> <th>Comments</th> </tr> </thead> <tbody> <tr> <td></td> <td></td> <td></td> <td></td> </tr> <tr> <td></td> <td></td> <td></td> <td></td> </tr> <tr> <td>A</td> <td>13/03/20</td> <td>DC</td> <td>Issue as draft to client</td> </tr> <tr> <td>A</td> <td>10/01/20</td> <td>LZ</td> <td>Began populating updated layout</td> </tr> </tbody> </table>						Rev	Date	Engineer	Comments									A	13/03/20	DC	Issue as draft to client	A	10/01/20	LZ	Began populating updated layout																																																																																																																																																																																																	
Rev	Date	Engineer	Comments																																																																																																																																																																																																																									
A	13/03/20	DC	Issue as draft to client																																																																																																																																																																																																																									
A	10/01/20	LZ	Began populating updated layout																																																																																																																																																																																																																									

# 24.9 Operating Cost – Option 6

**Title:** OPEX-20 Mtpa @ 85% Cu Recovery +CuSO4  
**Document No.:** J5329-ES-CA-000-001  
**Project:** Haib PEA  
**Client:** Deep-South Resources  
**Date:** 13-Mar-20  
**Rev:** A  
**Option:** Whole Ore Heap Leach  
**Accuracy:** ± 30%  
**Comments:**

Summary 1 - Cost per pound of copper produced (Based on Commodity)					
	Cost		Fixed %	Fixed Cost USD/a	Variable USD/a
	USD/a	USD/lb Cu Eq			
Power	\$19,162,721	\$0.16	15.0	\$2,874,408	\$16,288,313
Consumables	\$13,194,092	\$0.11	5.0	\$659,705	\$12,534,388
Reagents	\$51,455,665	\$0.43	0.0	\$0	\$51,455,665
Labour	\$5,879,177	\$0.05	100.0	\$5,879,177	\$0
Maintenance	\$4,693,606	\$0.04	15.0	\$704,041	\$3,989,565
Misc	\$1,200,000	\$0.01	100.0	\$1,200,000	\$0
<b>Total</b>	<b>\$95,585,262</b>	<b>\$0.79</b>	<b>11.8</b>	<b>\$11,317,331</b>	<b>\$84,267,931</b>

Summary 1 - Cost per tonne of concentrate (Based on Commodity)					
	Cost		Fixed Cost USD/a	Variable USD/a	Overall Distribution %
	USD/a	USD/t ROM			
Power	\$19,162,721	\$0.96	\$2,874,408	\$16,288,313	20.0
Consumables	\$13,194,092	\$0.66	\$659,705	\$12,534,388	13.8
Reagents	\$51,455,665	\$2.57	\$0	\$51,455,665	53.8
Labour	\$5,879,177	\$0.29	\$5,879,177	\$0	6.2
Maintenance	\$4,693,606	\$0.23	\$704,041	\$3,989,565	4.9
Miscellaneous	\$1,200,000	\$0.06	\$1,200,000	\$0	1.3
<b>Total</b>	<b>\$95,585,262</b>	<b>\$4.78</b>	<b>\$11,317,331</b>	<b>\$84,267,931</b>	<b>100.0</b>

Reagents					
	Price USD/unit	Unit	Consumption (unit/a)	Cost	
				USD/a	USD/t ROM
Sulphuric Acid	\$275	t	37607	\$12,034,277	0.60
Polyacrylamide	\$2,150	t	2927	\$6,425,317	0.32
LX064N	\$12,000	t	548	\$6,605,986	0.33
Quicklime	\$300	t	14418	\$4,974,071	0.25
Limestone	\$150	t	67327	\$13,126,672	0.66
Gabcrete/Dolomite	\$13	t	0	\$0	0.00
Kerosene	\$550	t	3108	\$1,849,164	0.09
Raw Water	\$1	kL	2477021	\$2,269,694	0.11
Flocculant	\$2,150	t	127	\$278,103	0.01
Diesel	\$1	L	3923449	\$3,990,380	0.19
<b>Total</b>				<b>\$51,455,665</b>	<b>\$2.57</b>

Maintenance					
	Mechanical Capital USD	Maintenance %	Cost		
			USD/a	USD/t ROM	
Crushing	\$33,812,000	5%	\$1,690,600	\$0.08	
HPGR	\$24,532,000	5%	\$1,226,600	\$0.06	
Agglomeration and Heap Leaching	\$25,049,000	1%	\$250,490	\$0.01	
Copper SX and EW	\$41,908,000	3%	\$1,257,240	\$0.06	
Iron Removal and Tailings	\$3,613,000	3%	\$108,390	\$0.01	
Process and Raw Water	\$2,357,000	1%	\$23,570	\$0.00	
Reagents	\$2,924,200	3%	\$87,726	\$0.00	
Services	\$1,633,000	3%	\$48,960	\$0.00	
<b>Total</b>	<b>\$135,828,200</b>	<b>3.46%</b>	<b>\$4,693,606</b>	<b>\$0.23</b>	

Plant Standby Cost					
	Assumptions and Bases	% of annual total cost	Standby Cost USD/a	Dist %	
Consumables	Air and water service costs persist	5.0	\$659,705	5.8	
Reagents	No reagent consumption due to no throughput	0.0	\$0	0.0	
Labour	All staff retain their positions	100.0	\$5,879,177	51.9	
Maintenance	Operational equipment maintenance	15.0	\$704,041	6.2	
Miscellaneous	Contract agreements	100.0	\$1,200,000	10.6	
<b>Total</b>		<b>11.8</b>	<b>\$11,317,331</b>	<b>100.0</b>	

	Power			Cost	
	Installed kW	Utilisation %	kW Draw	USD/a	USD/t ROM
Crushing	7,072	70	4,950	30,355,149	\$2,560,882
HPGR	8,607	90	7,746	61,071,929	\$5,152,272
Agglomeration and Heap Leaching	3,808	98	3,732	32,036,730	\$2,702,747
Copper SX and EW	13,785	90	12,407	97,814,727	\$8,252,042
Iron Removal and Tailings	313	90	281	2,215,131	\$187,215
Process and Raw Water	452	90	407	3,209,730	\$270,786
Reagents	39	90	35	278,942	\$23,533
Services	28	70	20	157,007	\$13,246
<b>Total</b>	<b>34,105</b>	<b>29.579</b>	<b>227,143,346</b>	<b>\$19,162,721</b>	<b>\$0.96</b>

	Unit	Consumables		Cost		
		Price USD/unit	Consumption (unit/a)	USD/a	Freight	USD/t ROM
Gyratory Crusher Liner - Mantle	set	\$200,000.00	4	\$800,000		\$72,000
Gyratory Crusher Liner - Concave	set	\$200,000.00	8	\$1,600,000		\$144,000
Cone Crusher Liners - Bowl	set	\$18,000.00	12	\$216,000		\$19,440
Cone Crusher Liners - Mantle	set	\$18,000.00	12	\$216,000		\$19,440
Secondary Screen	set	\$20,000.00	8	\$160,000		\$14,400
HPGR Liner and Plates	set	\$1,140,512.00	1	\$1,140,512		\$51,728
HPGR Double Deck Screen Liner	set	\$25,000.00	16	\$400,000		\$36,000
Pad Clearance	m2	\$0.65	354918	\$230,697		\$0.01
Pad Earthworks	m3	\$2.50	632023	\$1,580,058		\$0.08
Pad Liner	m2	\$8.40	354918	\$2,981,312		\$268,318
Irrigation Tubing	m	\$7.00	5384	\$37,685		\$3,392
Replacement Cathodes	set	\$150.00	2259	\$338,820		\$30,494
Replacement Anodes	set	\$200.00	2259	\$451,760		\$40,658
Copper Sulfate Bags	each	\$12.50	51081	\$638,511		\$57,466
Copper Sulfate Pallets	each	\$15.00	51081	\$766,213		\$68,959
Oil	t	\$900.00	926	\$833,333		\$75,000
Grease	t	\$450.00	926	\$416,867		\$37,500
Air Filters	set	\$3,745.26	1	\$1,075		\$189
Mobile Lighting Tower Parts	set	\$700.00	3	\$2,100		\$189
Light Vehicle Parts	set	\$350.00	6	\$2,100		\$189
Water Truck Parts	set	\$2,100.00	1	\$2,100		\$189
Forklift Parts	set	\$1,750.00	2	\$3,500		\$315
Ambulance Parts/Consumables	set	\$700.00	1	\$700		\$63
<b>Total</b>				<b>\$13,194,092</b>		<b>\$0.66</b>

Rev	Date	Engineer	Comments
A	13/03/20	DC	Issue as draft to client
A	6/03/20	LZ	Began populating updated layout

Key Inputs and Outputs		
Plant Throughput dry	20,000,000	tpa
Utilisation (Crushing)	6,132	n/a
Utilisation (Grinding)	7,684	n/a
Plant Throughput dry	2,537	gphz
Head Grade	0.310%	% Cu
Recovery	85	% Cu
Annual Production	38,337	t Cu
	84,518,099	lb Cu
	51,081	t CuSO4.5H2O
	112,613,875	lb CuSO4.5H2O
	120,344,334	Total lb Cu Eq
Power Cost	\$0.084	USD/kWh
Total Power	11.36	kWh/t
Abrasion Index	0.49	
Fixed Component	\$11,317,331	USD/a
Fixed Component	\$0.57	USD/t ROM
Variable Component	\$84,267,931	USD/a
Variable Component	\$4.21	USD/t ROM
Operating Cost Estimation	\$4.78	USD/t ROM
Operating Cost Estimation	\$0.79	USD/lb Cu Eq

Miscellaneous Costs Only		
	Cost USD/a	USD/t ROM
Laboratory Costs	\$1,000,000	\$0.05
Contractors	\$100,000	\$0.01
Vehicle Fleet	\$100,000	\$0.01
<b>Total</b>	<b>\$1,200,000</b>	<b>\$0.06</b>

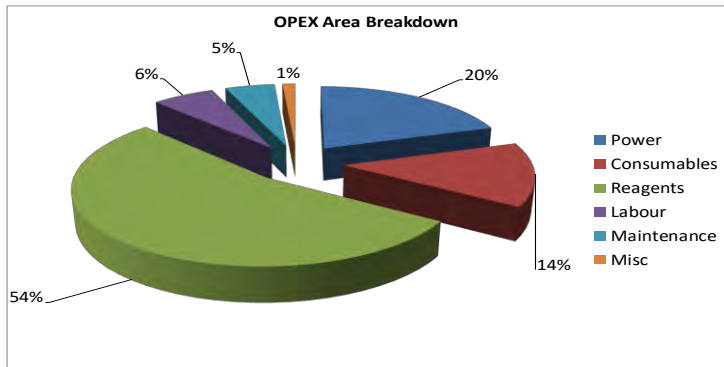

## **24.10 Accuracy Assessment**

At a scoping study level the accuracy is assumed to be at  $\pm 35\%$  of the OPEX.

## 25. ECONOMIC ANALYSIS

### 25.1 Introduction

The project economic assessment has been conducted by METS and is developed based on accurate and up-to-date information. The economic analysis includes the calculation of Net Present Value (NPV) on a pre-tax basis. The estimates assume that the production, cost targets, pricing and sales goals are achieved. Any deviation from those values affects the determination of NPV. The internal rate of return (IRR), payback period and other financial metrics were calculated to assist with determining the project's viability.

### 25.2 Macro-Economic Assumptions

#### 25.2.1 Metal Price Assumptions

Table 25-1: Assumed pricing data

Commodity	Units	Unit Price (US \$)
LME copper	lb	2.00
LME copper	lb	2.25
LME copper	lb	2.50
LME copper	lb	2.85
LME copper	lb	3.00
LME copper	lb	3.25
LME copper	lb	3.50
LME copper	lb	3.75
LME copper	lb	4.00
Copper sulfate pentahydrate – premium	% contained copper	25
Copper sulfate pentahydrate	lb	0.64 @ 2.00 copper price
		0.72 @ 2.25 copper price
		0.80 @ 2.50 copper price
		0.91 @ 2.85 copper price
		0.95 @ 3.00 copper price
		1.03 @ 3.25 copper price
		1.11 @ 3.50 copper price
		1.19 @ 3.75 copper price
		1.27 @ 4.00 copper price

### **25.2.2 Royalties**

The royalty for gold, copper, zinc and other base metals is 3% of the total revenue.

### **25.2.3 Taxes**

The corporate tax for non-diamond mining in Namibia is 37.5% (as per the Chamber of Mines Namibia).

### **25.2.4 Financing**

The economic analysis has been run on a basis of 100 percent equity financing.

### **25.2.5 Inflation**

The economic analysis does not account for inflation.

### **25.2.6 Mining Costs**

Mining Costs have been assumed to be US\$ 2.26 per tonne. The mining is assumed to be equal to the Tschudi Heap Leach Project, which has the mining cost estimate published on the public domain.

### **25.2.7 Rail Freight**

Rail freight has been set to US\$ 45 per tonne of products to send the products to Luderitz port. This is estimated via US\$ 0.075/tkm and a 600 km freight distance.

### **25.2.8 Wharfage and Ship Loading**

The wharfage and shiploading costs have been assumed to be \$US 5 per tonne of products to account for port costs and shipping costs.

### **25.2.9 Discount Rate**

A discount rate of 7.5% has been incorporated for the base case scenarios. The sensitivity analysis assessed step changes of 1.25%.

### **25.2.10 Exchange Rate**

Where applicable, a Namibian dollar to US dollar of 0.07 was incorporated. When estimating costs from quotes METS have received in Australian dollars, an Australian dollar to US dollar exchange rate of 0.67 was used.

## **25.3 Technical Assumptions**

It is assumed that the project ramp up will be achieved over three years. Due to delayed leach extractions, the first year is assumed to achieve 25% of the design production, 75% in the second year and 100% by the third year.



## 25.4 Economic Outcomes – Option 1 (Base Case)

The economic outcomes of the 8.5 Mtpa with 80% copper recovery producing LME copper and copper sulfate scenario are summarised in Table 25-2.

**Table 25-2: Option 1 - Project Metrics**

8.5 Mtpa @ 80% Cu Recovery + CuSO <sub>4</sub>									
LME Cu, tpa	7,690.4								
CuSO <sub>4</sub> .5H <sub>2</sub> O, tpa	51,080.9								
CAPEX, USD	\$195,552,816								
Processing OPEX, USD/year	\$48,905,853								
<b>Copper Price, USD/lb</b>	<b>\$2.00</b>	<b>\$2.25</b>	<b>\$2.50</b>	<b>\$2.85</b>	<b>\$3.00</b>	<b>\$3.25</b>	<b>\$3.50</b>	<b>\$3.75</b>	<b>\$4.00</b>
Avg. Annual Revenue LME Cu (USD/year)	\$33,908,942	\$38,147,560	\$42,386,178	\$48,320,243	\$50,863,413	\$55,102,031	\$59,340,649	\$63,579,266	\$67,817,884
Avg. Annual Revenue CuSO <sub>4</sub> (USD/year)	\$71,677,731	\$80,637,447	\$89,597,163	\$102,140,766	\$107,516,596	\$116,476,313	\$125,436,029	\$134,395,745	\$143,355,462
Total Cost, USD/t ROM	\$8.93	\$8.98	\$9.03	\$9.09	\$9.12	\$9.16	\$9.21	\$9.26	\$9.30
Total Cost, USD/lb CuEq	\$1.44	\$1.45	\$1.45	\$1.46	\$1.47	\$1.48	\$1.48	\$1.49	\$1.50
NPV <sub>7.5%,pre-tax</sub>	\$165,330,061	\$321,070,640	\$476,811,220	\$694,848,031	\$788,292,378	\$944,032,958	\$1,099,773,537	\$1,255,514,117	\$1,411,254,696
IRR <sub>pre-tax</sub>	13.4%	18.5%	23.2%	29.4%	32.0%	36.1%	40.0%	43.8%	47.5%
Payback Period <sub>pre-tax</sub>	9.97	7.11	5.58	4.34	3.97	3.5	3.1	2.9	2.6
NPV <sub>7.5%,post-tax</sub>	\$119,122,442	\$216,460,304	\$313,798,166	\$450,071,173	\$508,473,891	\$605,811,753	\$703,149,615	\$800,487,477	\$897,825,339
IRR <sub>post-tax</sub>	11.8%	15.1%	18.2%	22.4%	24.1%	26.9%	29.6%	32.2%	34.8%
Payback Period <sub>post-tax</sub>	11.84	9.08	7.38	5.86	5.38	4.8	4.3	3.9	3.5
Strip Ratio	0.71:1								
LOM, years	55								

**Figure 25-1: Option 1 NPV and Sensitivity Results**

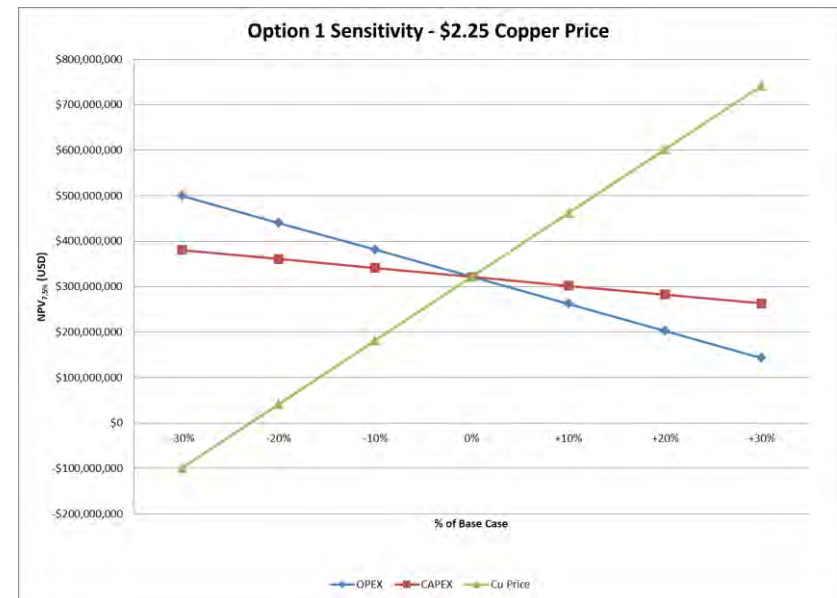
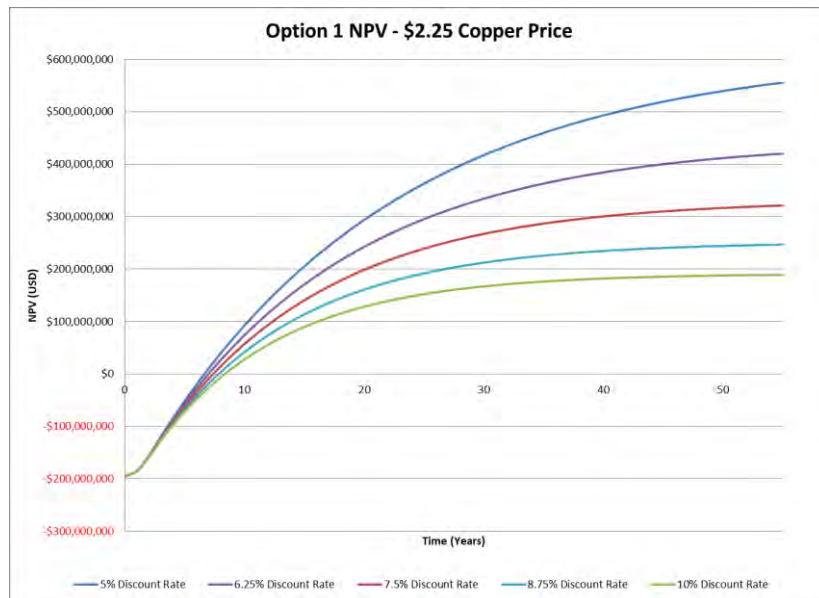
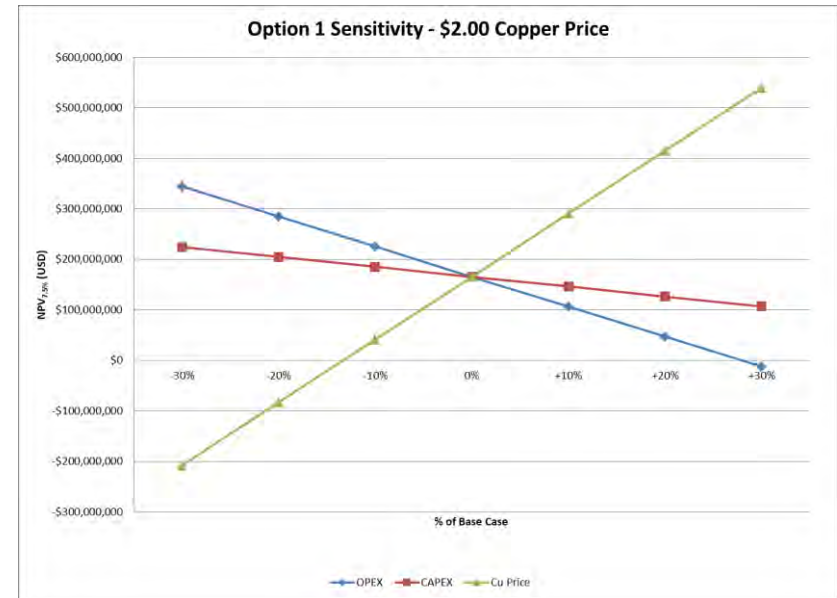
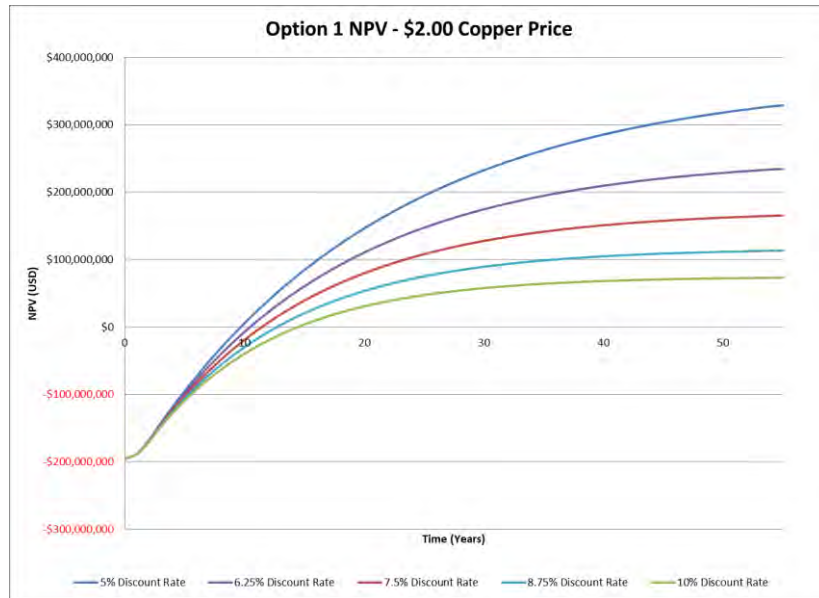

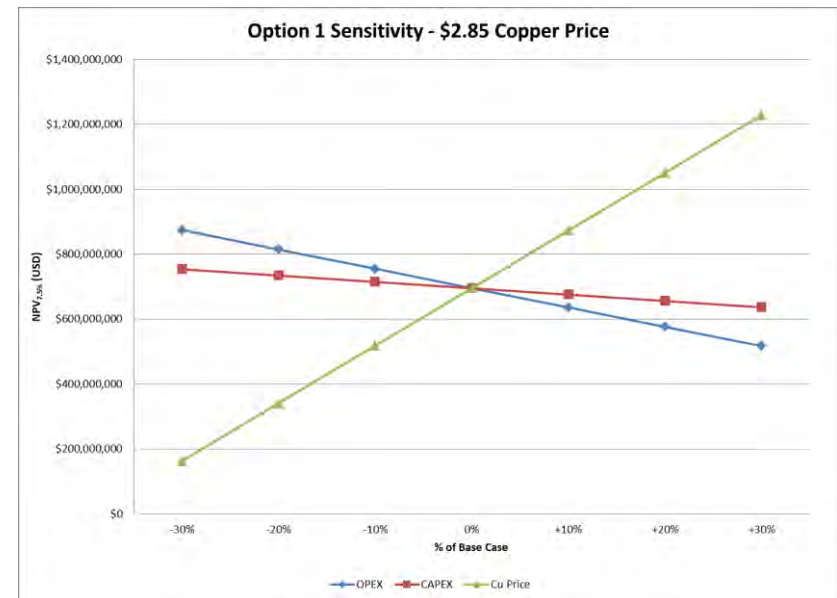
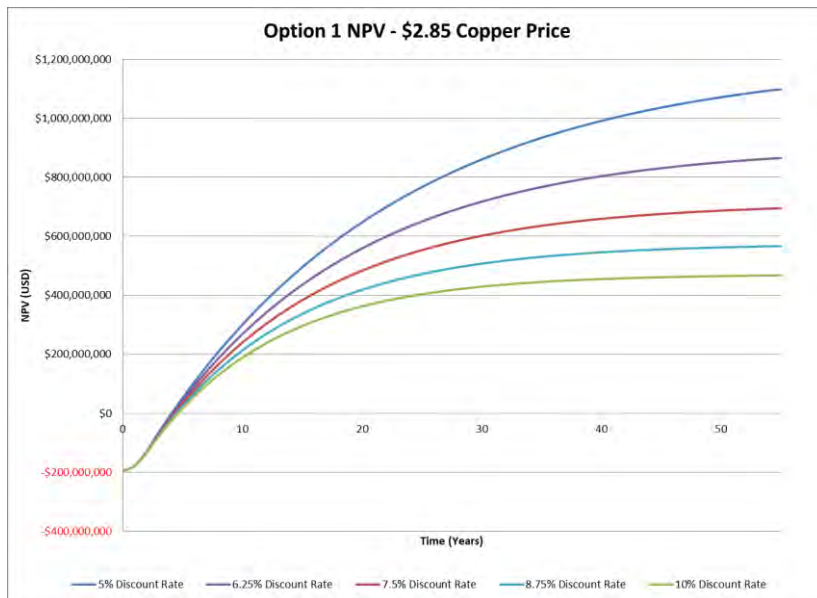
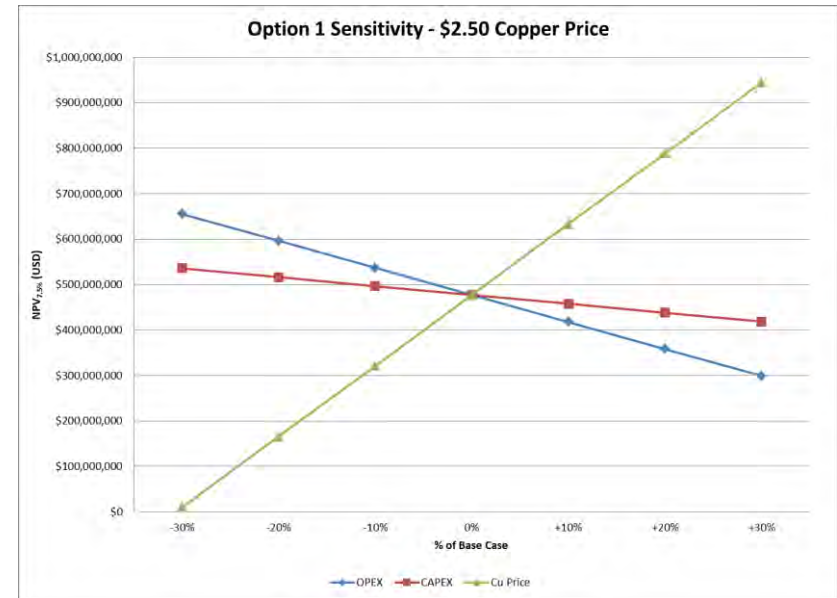
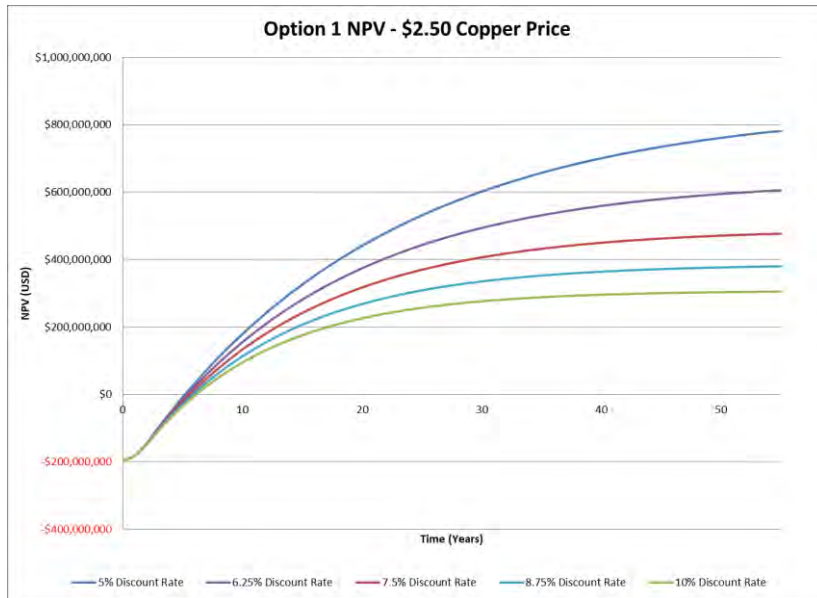

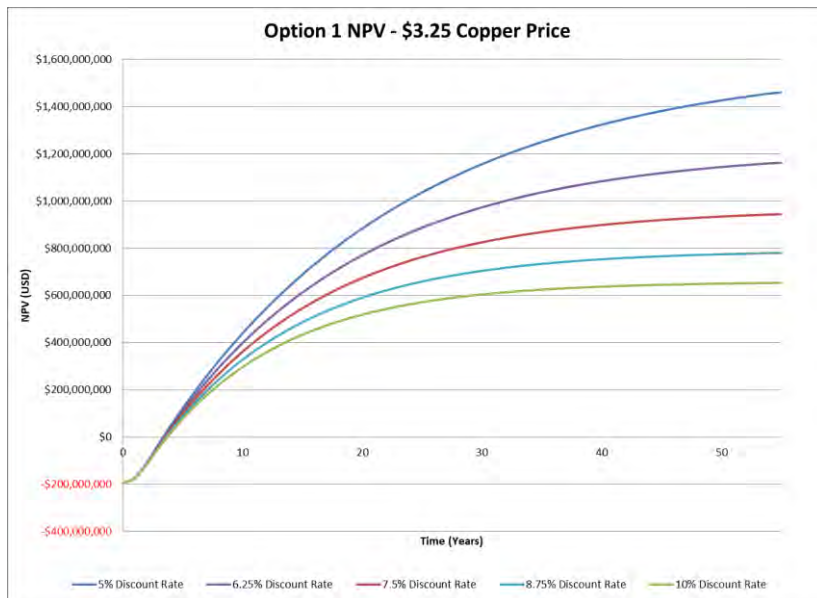
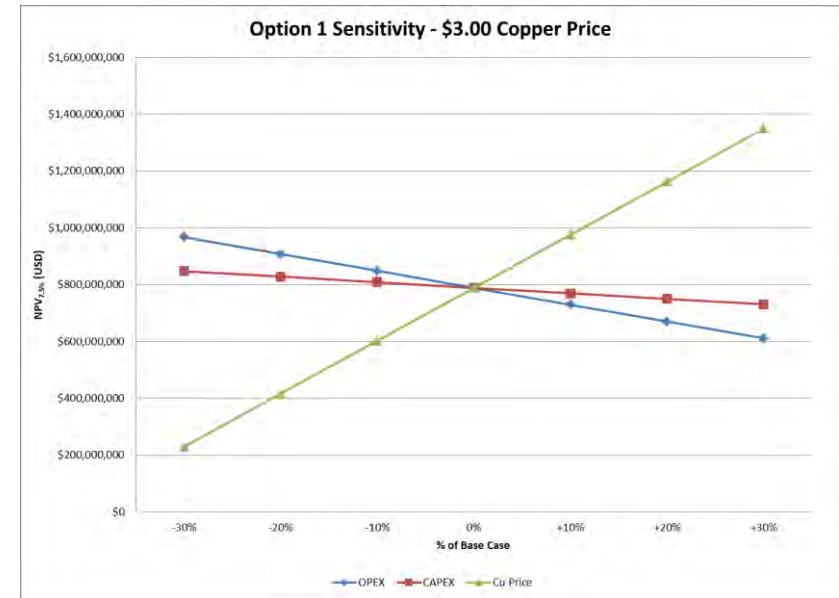
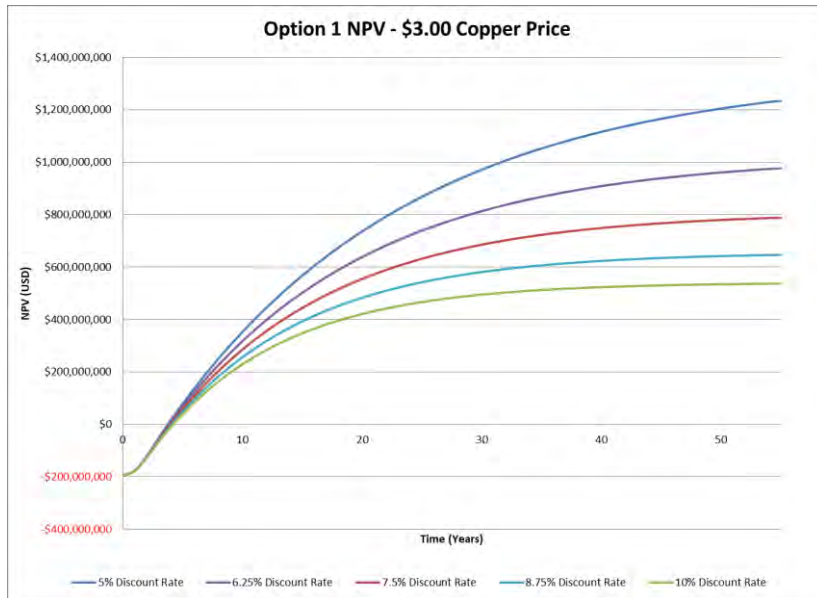

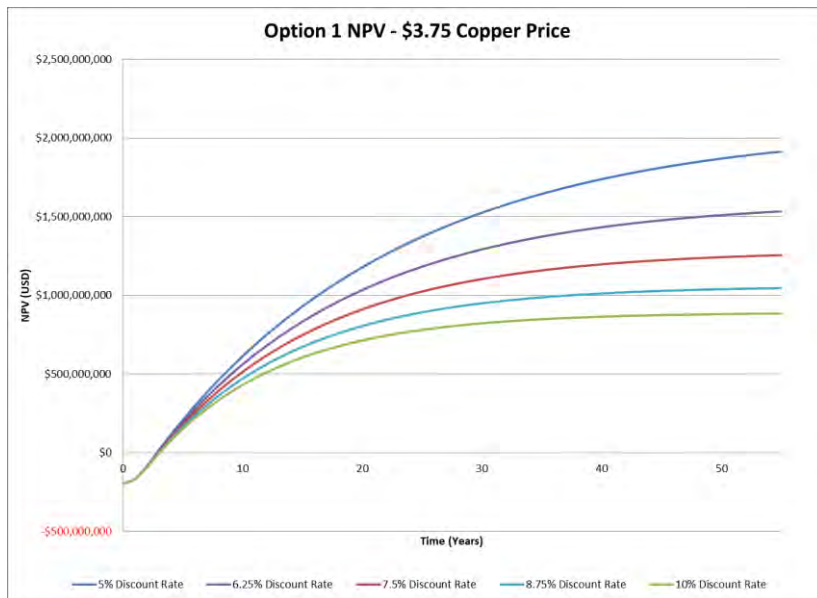
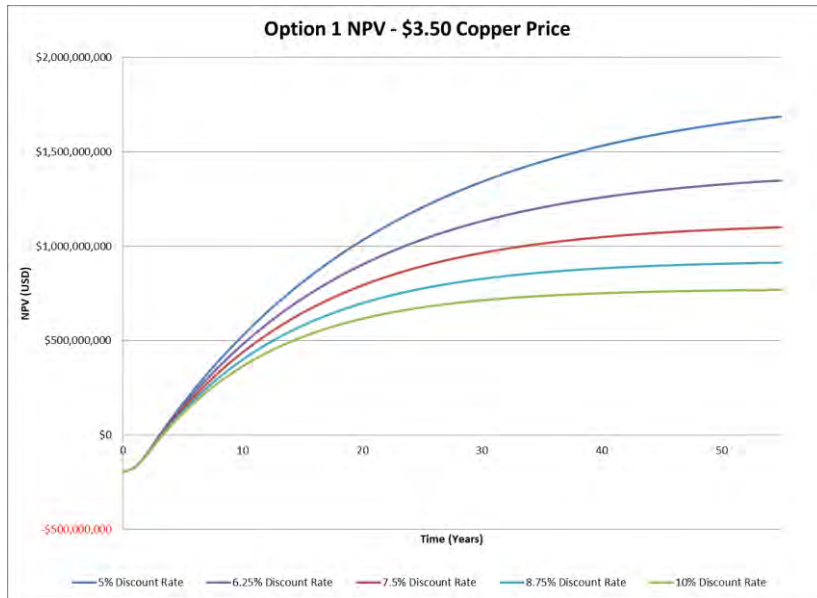

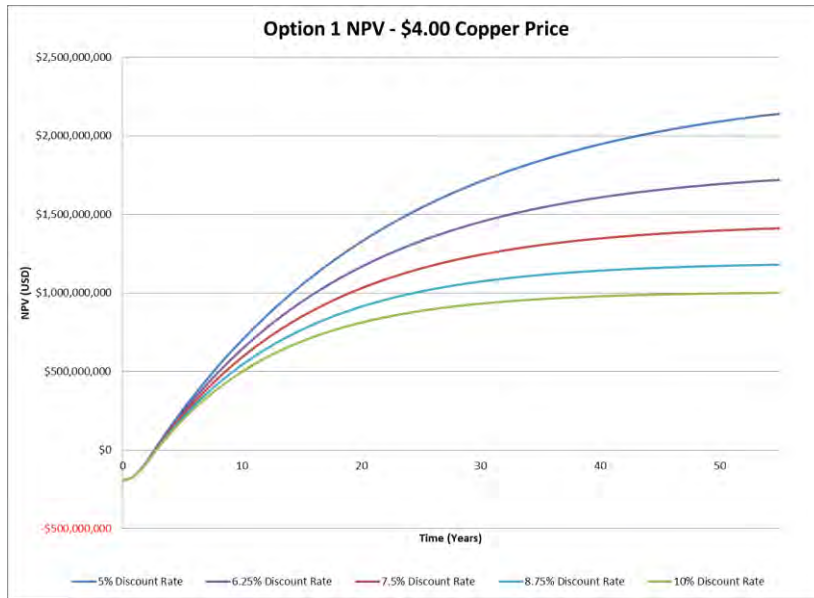

## 25.5 Economic Outcomes – Option 2

The economic outcomes of the 8.5 Mtpa with 85% copper recovery producing LME copper only scenario are summarised in Table 25-3.

**Table 25-3: Option 2 - Project Metrics**

8.5 Mtpa @ 85% Cu Recovery									
LME Cu, tpa	21,707.9								
CAPEX, USD	\$198,183,056								
Processing OPEX, USD/year	\$43,371,684								
<b>Copper Price, USD/lb</b>	<b>\$2.00</b>	<b>\$2.25</b>	<b>\$2.50</b>	<b>\$2.85</b>	<b>\$3.00</b>	<b>\$3.25</b>	<b>\$3.50</b>	<b>\$3.75</b>	<b>\$4.00</b>
Avg. Annual Revenue LME Cu (USD/year)	\$95,715,140	\$107,679,532	\$119,643,925	\$136,394,074	\$143,572,710	\$155,537,102	\$167,501,495	\$179,465,887	\$191,430,280
Total Cost, USD/t ROM	\$8.03	\$8.07	\$8.11	\$8.17	\$8.20	\$8.24	\$8.28	\$8.32	\$8.37
Total Cost, USD/lb CuEq	\$1.43	\$1.43	\$1.44	\$1.45	\$1.46	\$1.46	\$1.47	\$1.48	\$1.49
NPV <sub>7.5%,pre-tax</sub>	\$136,081,241	\$277,261,287	\$418,441,333	\$616,093,398	\$700,801,425	\$841,981,471	\$983,161,517	\$1,124,341,563	\$1,265,521,609
IRR <sub>pre-tax</sub>	12.4%	17.0%	21.3%	27.0%	29.3%	33.1%	36.7%	40.3%	43.7%
Payback Period <sub>pre-tax</sub>	10.86	7.78	6.12	4.75	4.35	3.8	3.4	3.1	2.9
NPV <sub>7.5%,post-tax</sub>	\$101,054,325	\$189,291,854	\$277,529,383	\$401,061,923	\$454,004,440	\$542,241,969	\$630,479,497	\$718,717,026	\$806,954,555
IRR <sub>post-tax</sub>	11.2%	14.1%	17.0%	20.7%	22.3%	24.9%	27.3%	29.8%	32.1%
Payback Period <sub>post-tax</sub>	12.60	9.77	7.99	6.38	5.87	5.2	4.7	4.2	3.9
Strip Ratio	0.71:1								
LOM, years	55								

**Figure 25-2: Option 2 NPV and Sensitivity Results**

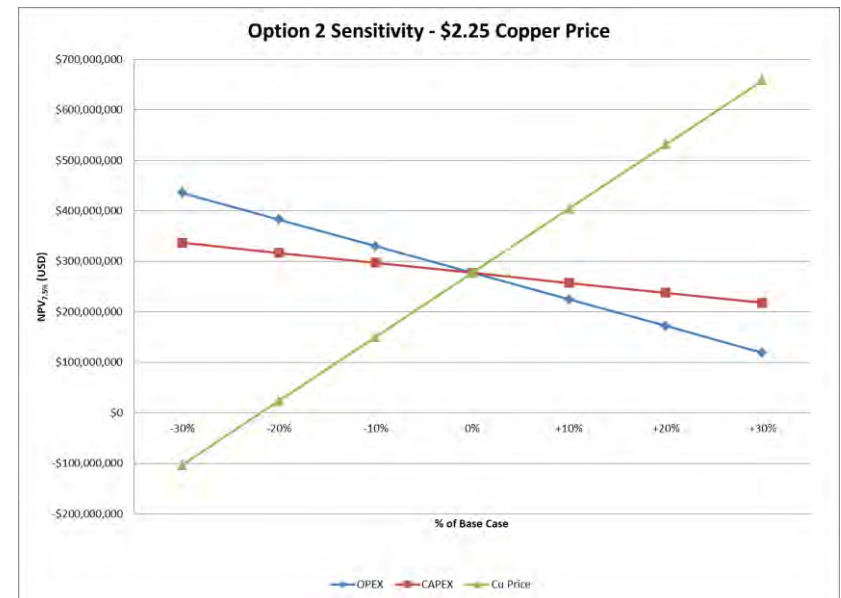
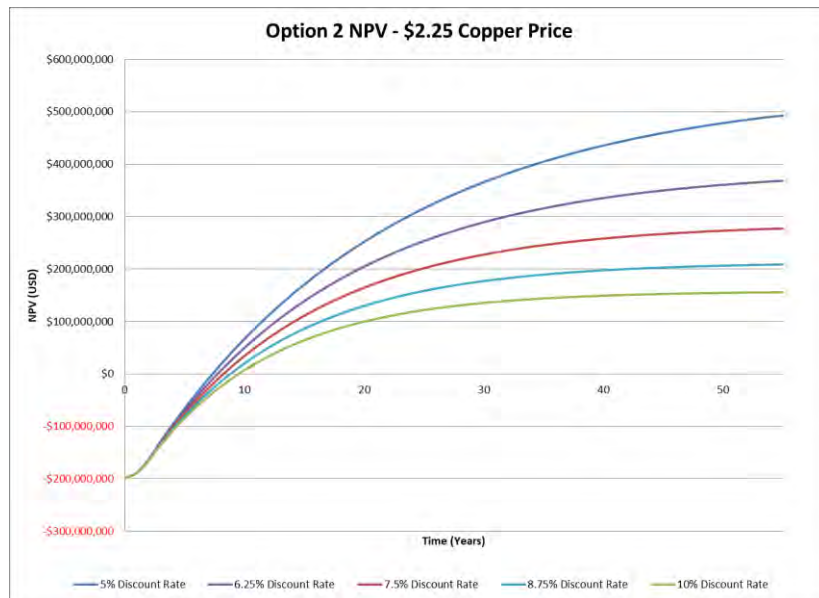
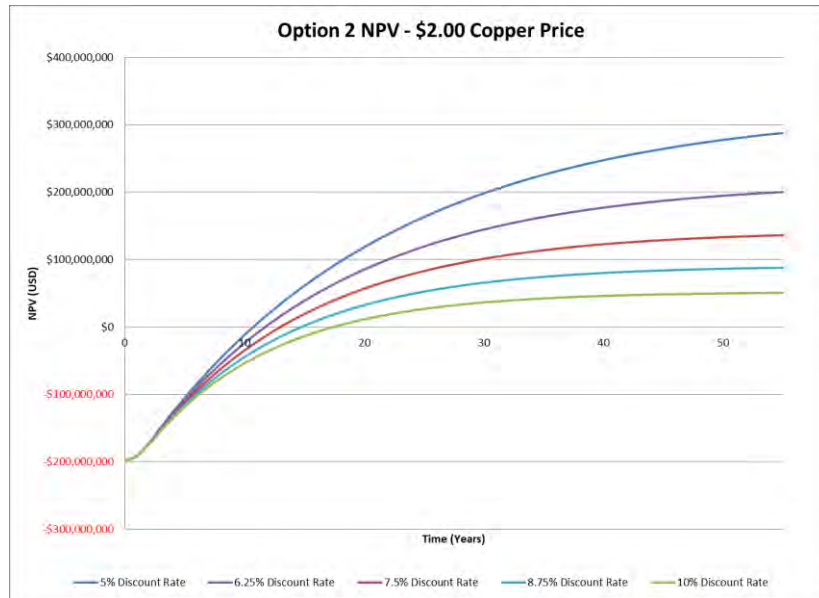



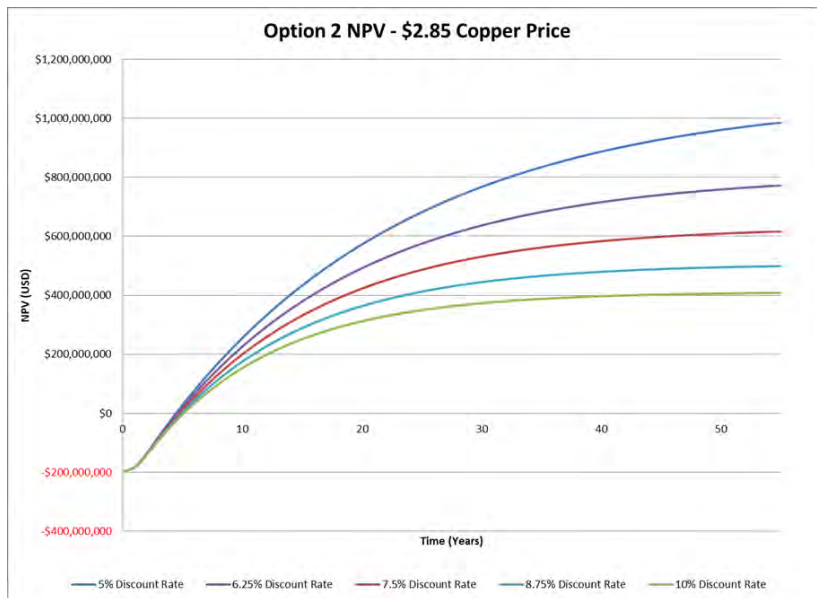
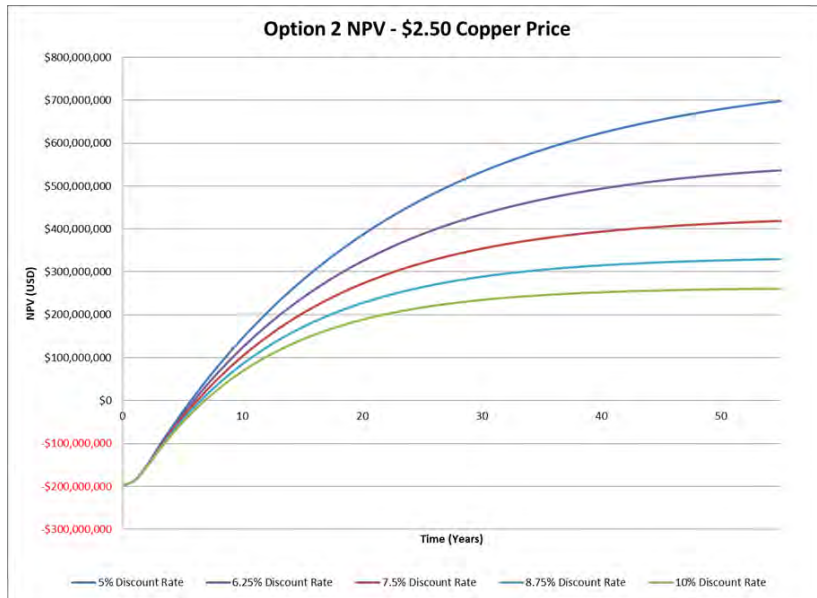

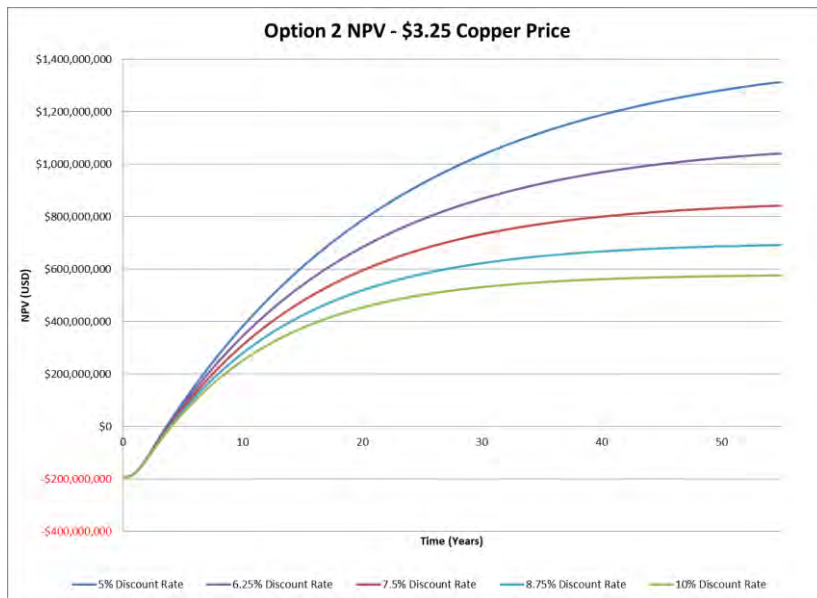
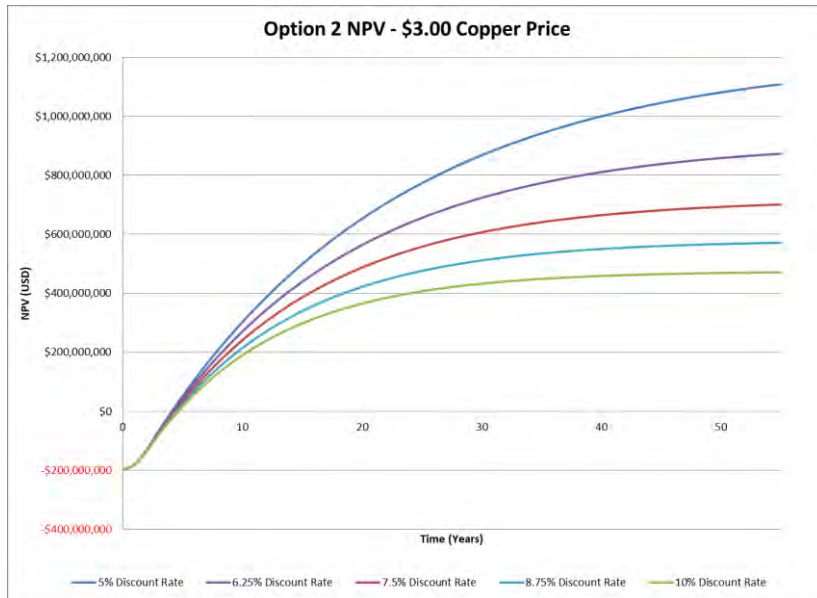

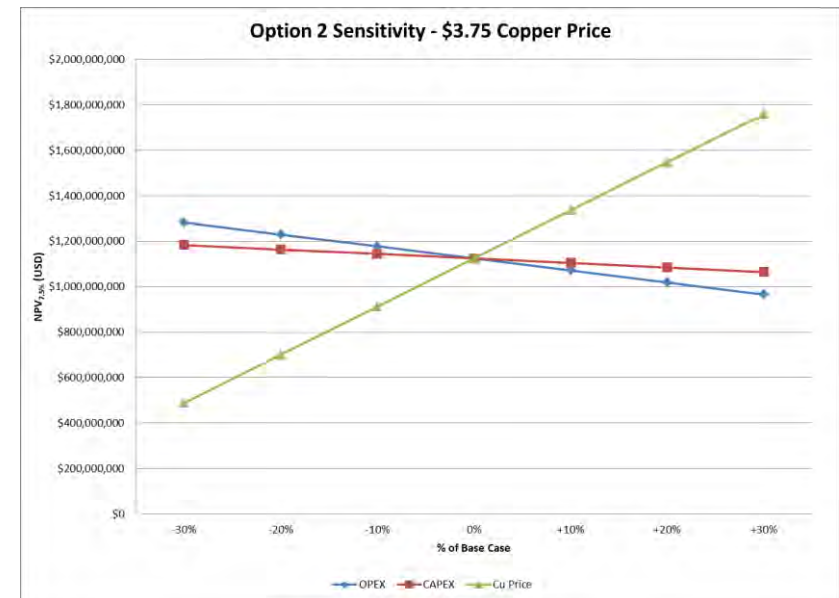
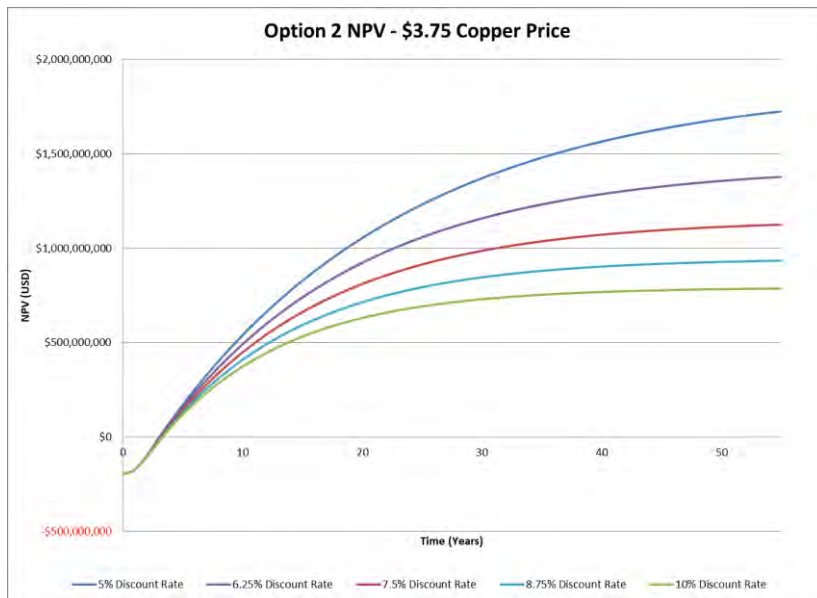
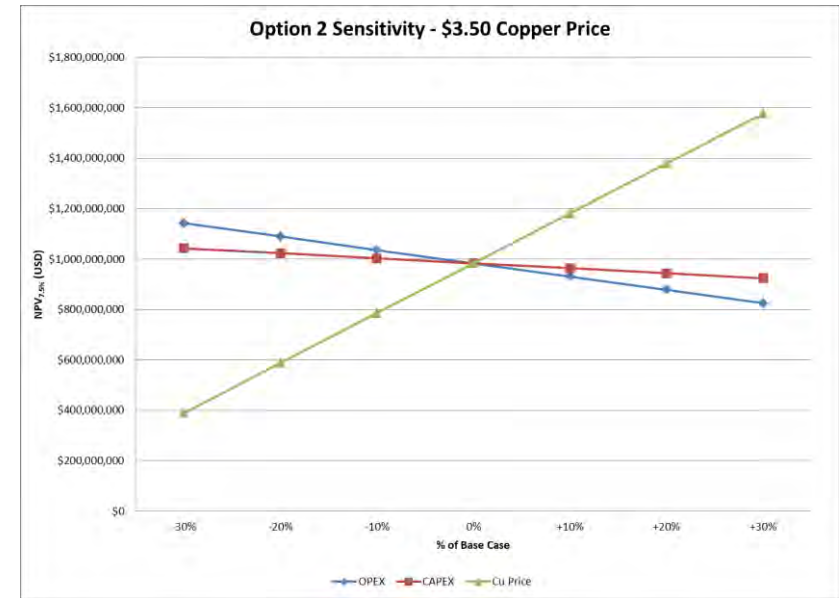
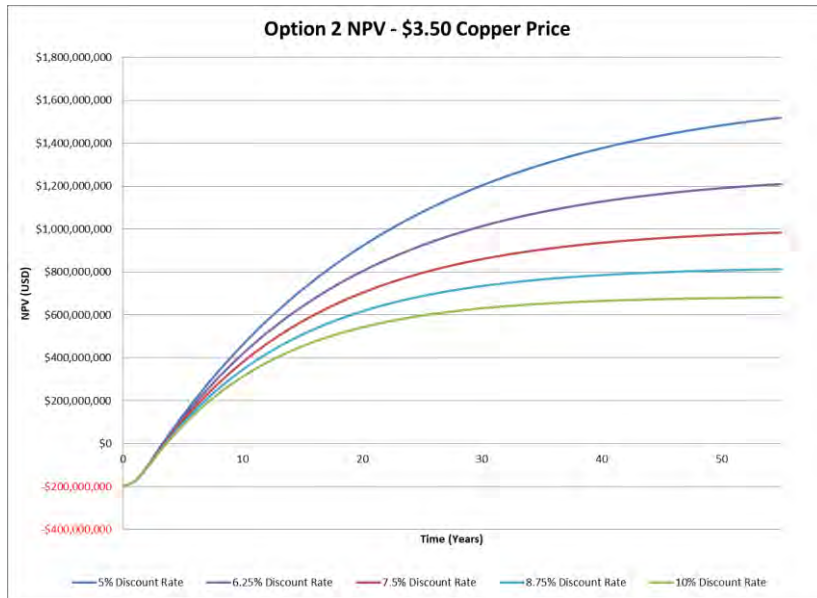

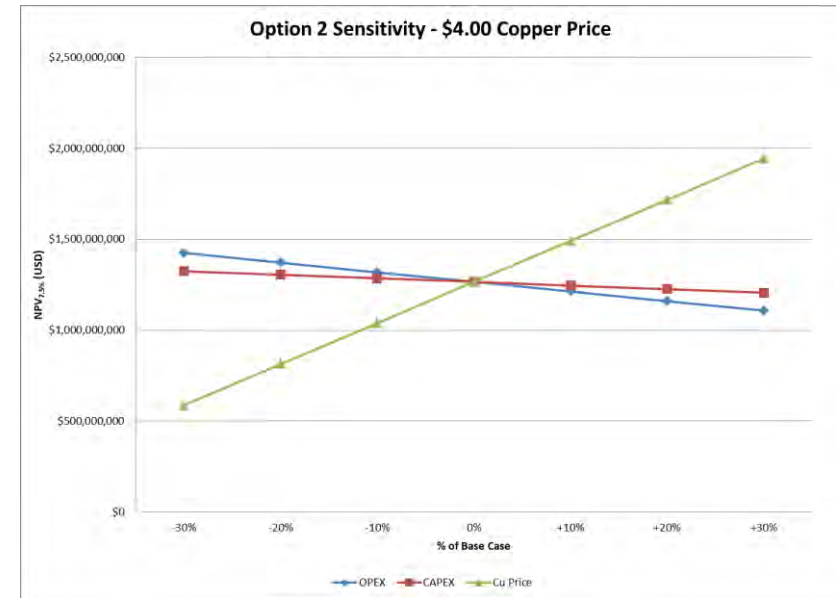
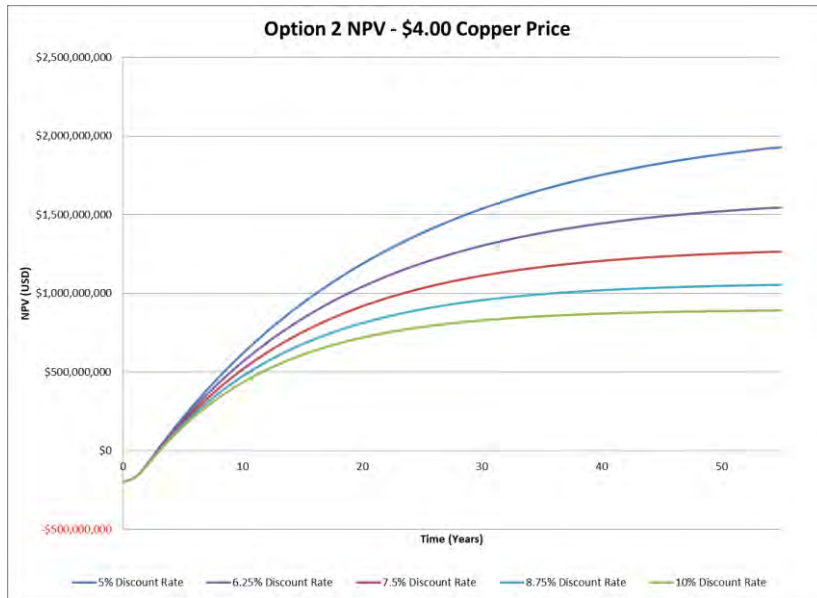

## 25.6 Economic Outcomes – Option 3

The economic outcomes of the 8.5 Mtpa with 85% copper recovery producing LME copper and copper sulfate scenario are summarised in Table 25-4.

**Table 25-4: Option 3 - Project Metrics**

8.5 Mtpa @ 85% Cu Recovery + CuSO <sub>4</sub>									
LME Cu, tpa	8,967.4								
CuSO <sub>4</sub> .5H <sub>2</sub> O, tpa	51,080.9								
CAPEX, USD	\$196,672,119								
Processing OPEX, USD/year	\$50,945,540								
<b>Copper Price, USD/lb</b>	<b>\$2.00</b>	<b>\$2.25</b>	<b>\$2.50</b>	<b>\$2.85</b>	<b>\$3.00</b>	<b>\$3.25</b>	<b>\$3.50</b>	<b>\$3.75</b>	<b>\$4.00</b>
Avg. Annual Revenue LME Cu (USD/year)	\$39,539,245	\$44,481,650	\$49,424,056	\$56,343,424	\$59,308,867	\$64,251,273	\$69,193,678	\$74,136,084	\$79,078,490
Avg. Annual Revenue CuSO <sub>4</sub> (USD/year)	\$71,677,731	\$80,637,447	\$89,597,163	\$102,140,766	\$107,516,596	\$116,476,313	\$125,436,029	\$134,395,745	\$143,355,462
Total Cost, USD/t ROM	\$9.20	\$9.25	\$9.30	\$9.37	\$9.40	\$9.44	\$9.49	\$9.54	\$9.59
Total Cost, USD/lb CuEq	\$1.41	\$1.41	\$1.42	\$1.43	\$1.44	\$1.44	\$1.45	\$1.46	\$1.47
NPV <sub>7.5%,pre-tax</sub>	\$205,059,396	\$369,104,685	\$533,149,973	\$762,813,377	\$861,240,550	\$1,025,285,838	\$1,189,331,127	\$1,353,376,415	\$1,517,421,704
IRR <sub>pre-tax</sub>	14.7%	19.9%	24.8%	31.1%	33.8%	38.0%	42.1%	46.0%	49.8%
Payback Period <sub>pre-tax</sub>	9.05	6.57	5.21	4.08	3.75	3.3	3.0	2.7	2.5
NPV <sub>7.5%,post-tax</sub>	\$144,043,662	\$246,571,967	\$349,100,272	\$492,639,900	\$554,156,883	\$656,685,188	\$759,213,493	\$861,741,799	\$964,270,104
IRR <sub>post-tax</sub>	12.7%	16.0%	19.3%	23.6%	25.3%	28.2%	31.0%	33.7%	36.4%
Payback Period <sub>post-tax</sub>	11.01	8.50	6.93	5.53	5.09	4.5	4.0	3.7	3.3
Strip Ratio	0.71:1								
LOM, years	55								

**Figure 25-3: Option 3 NPV and Sensitivity Results**

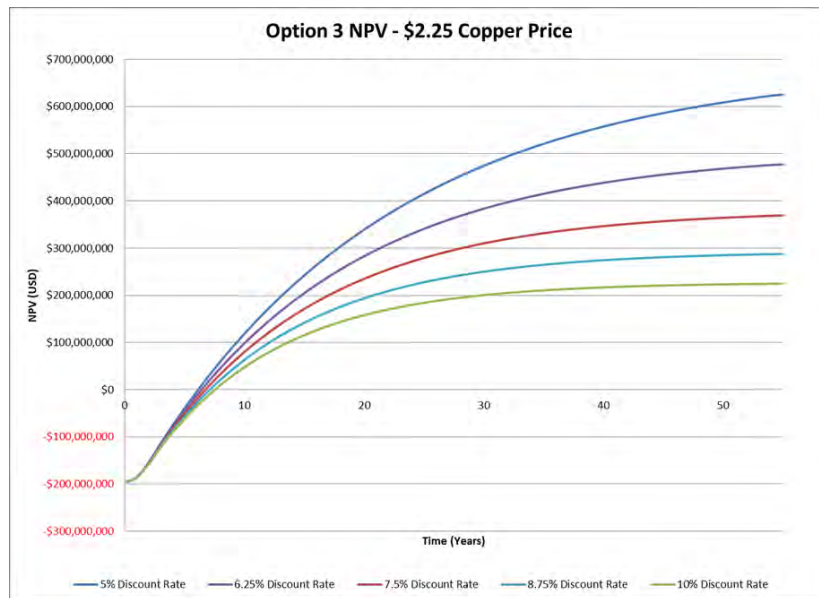
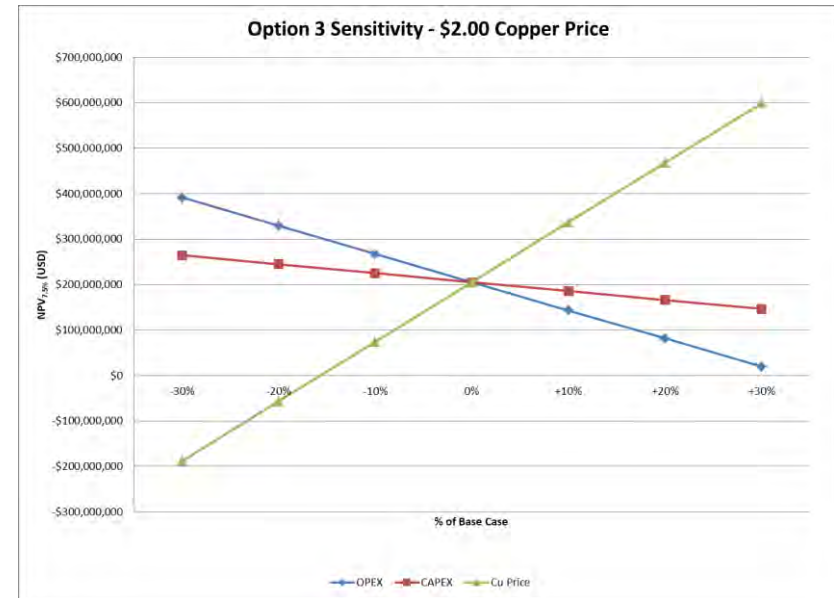
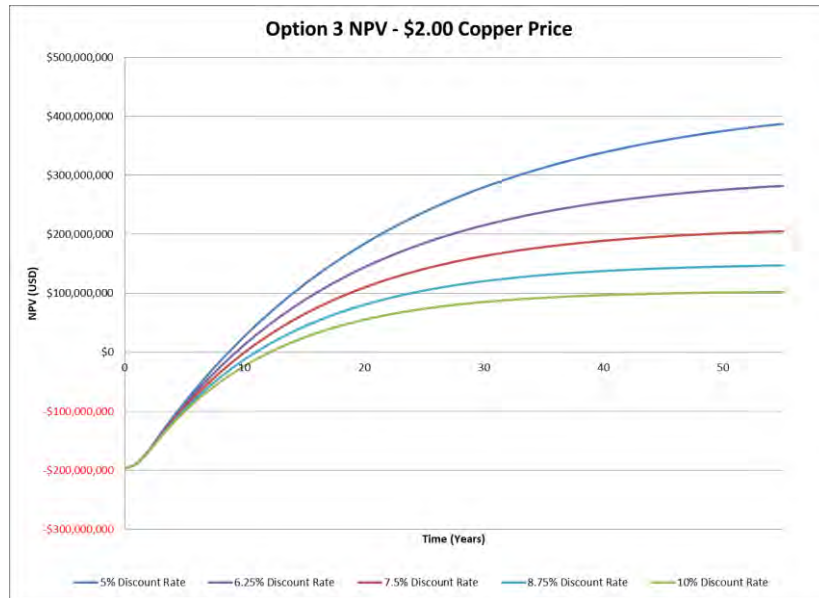

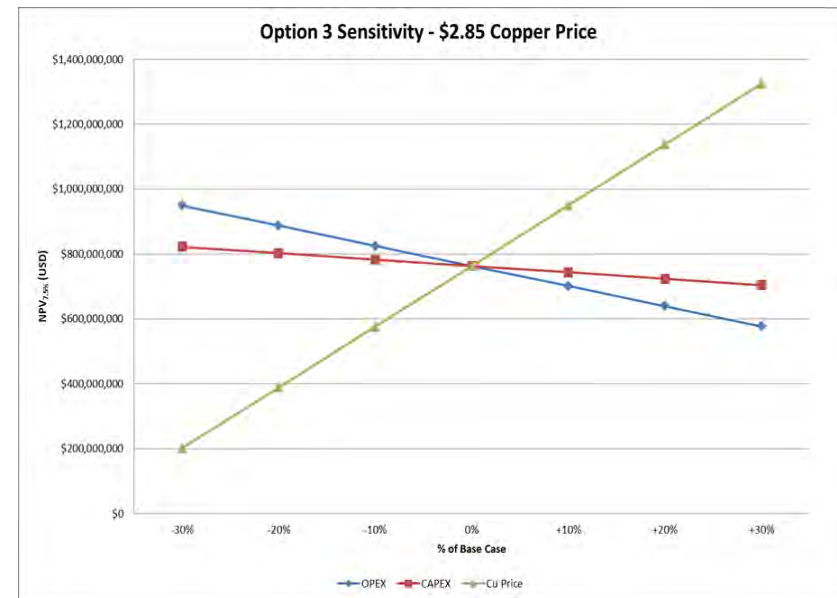
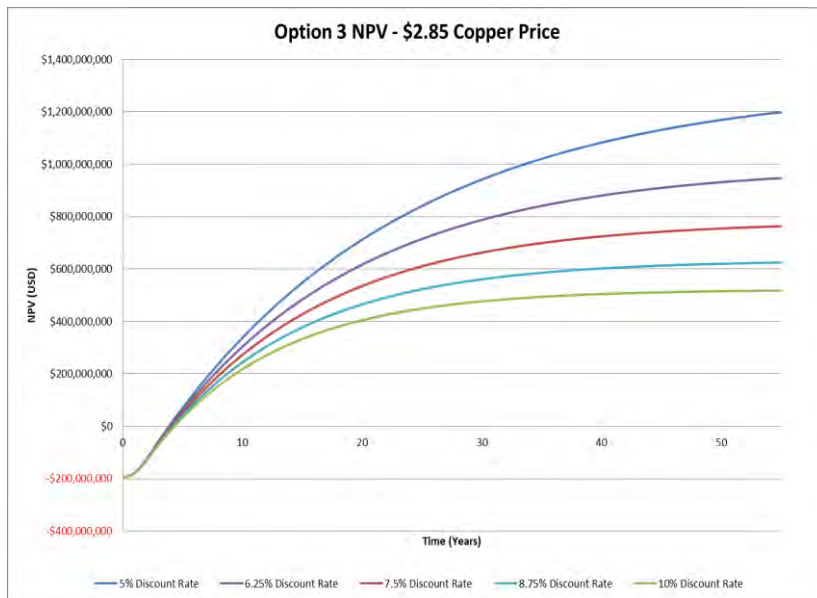
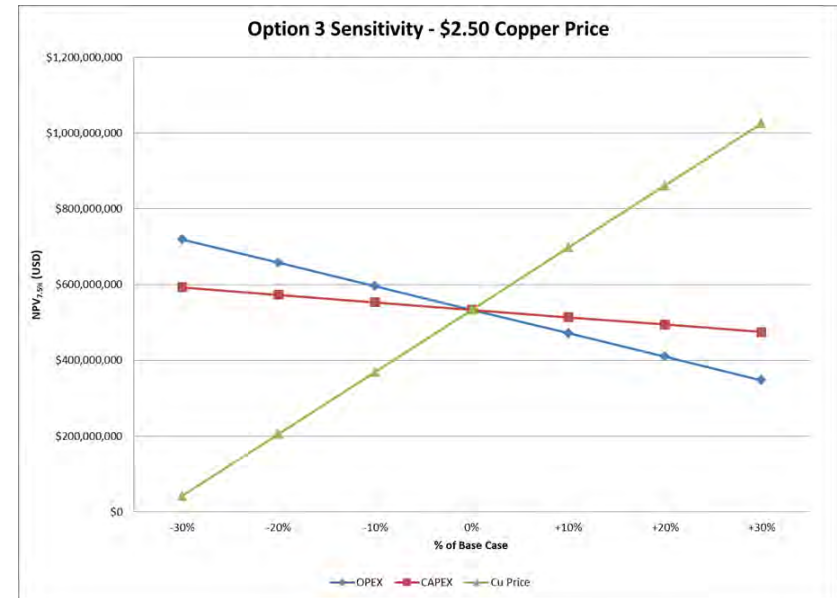
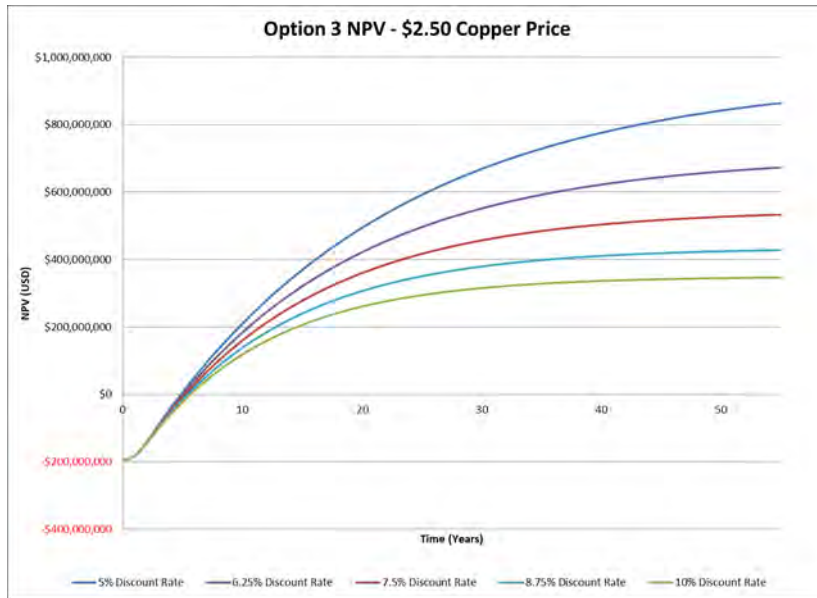

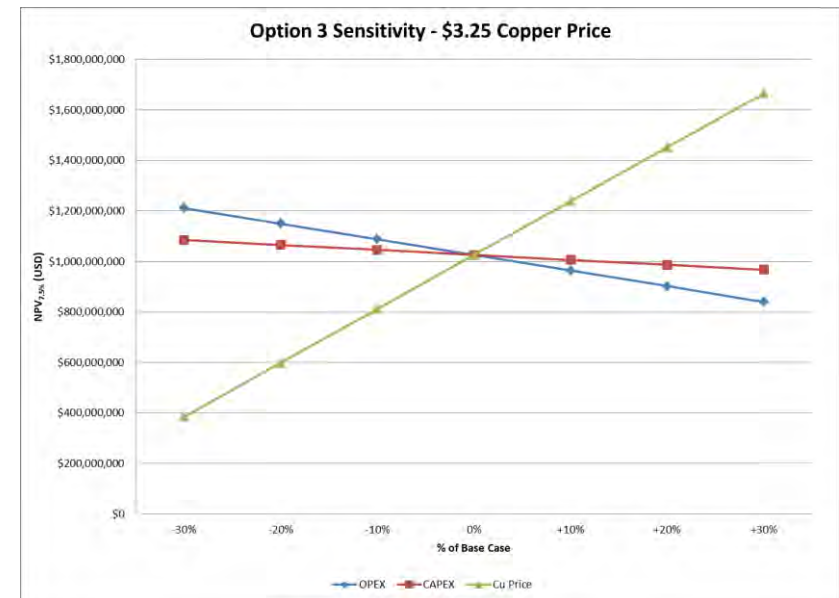
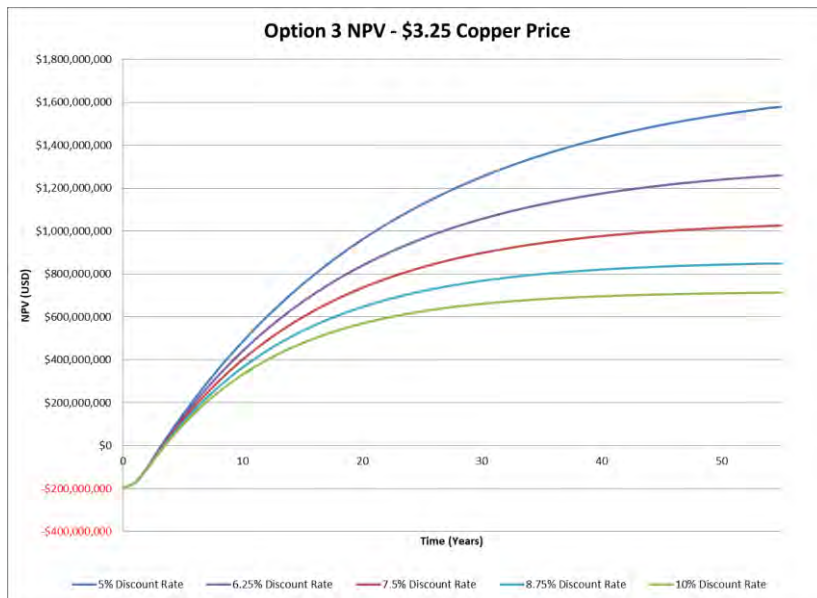



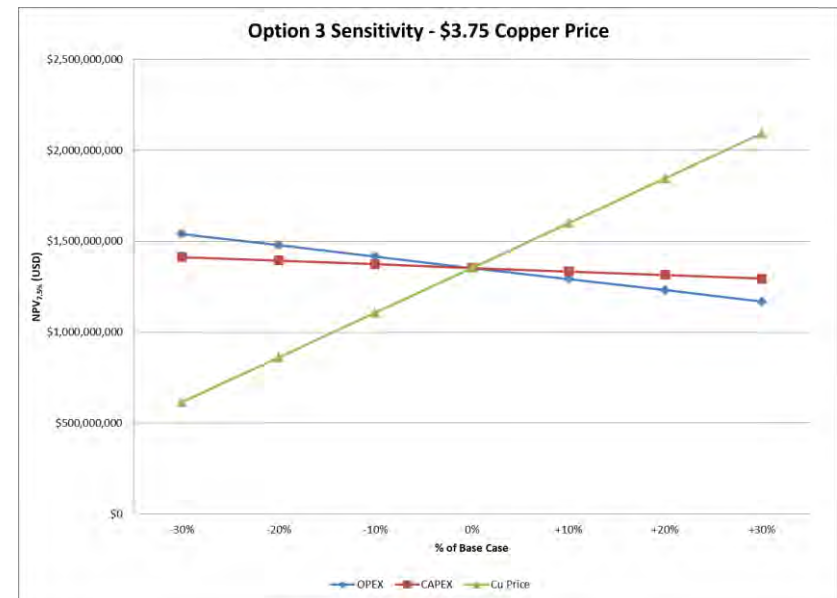
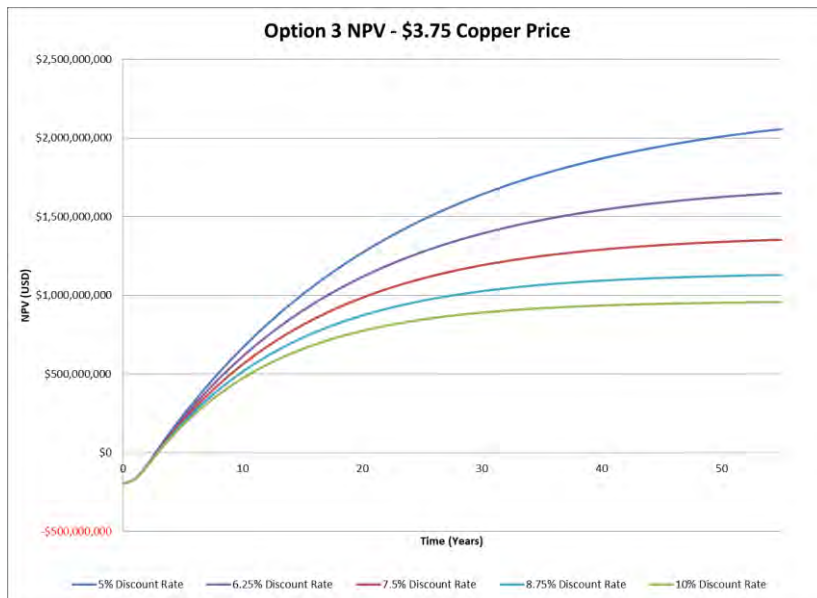
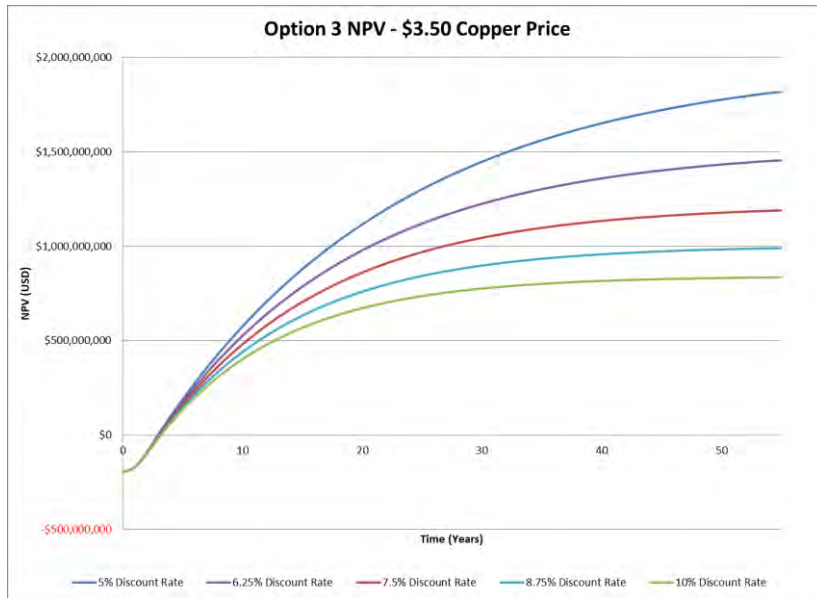

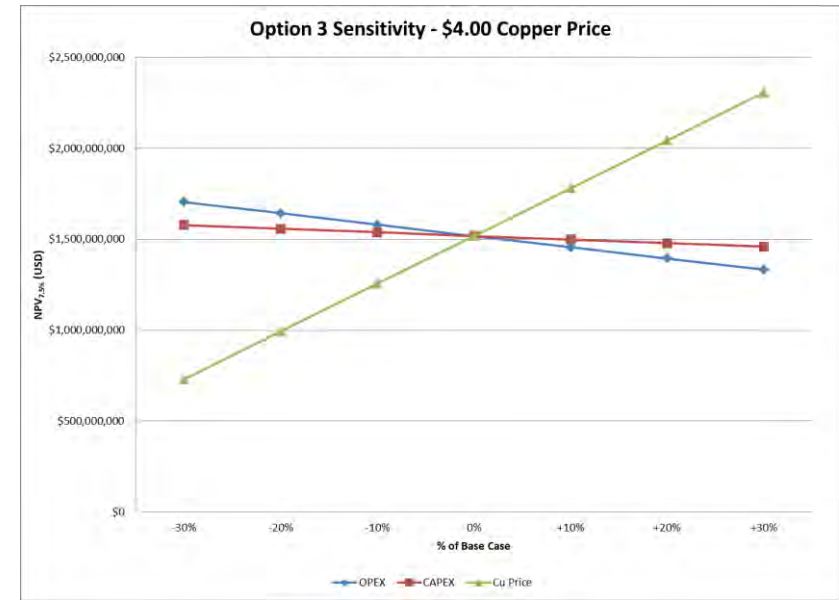
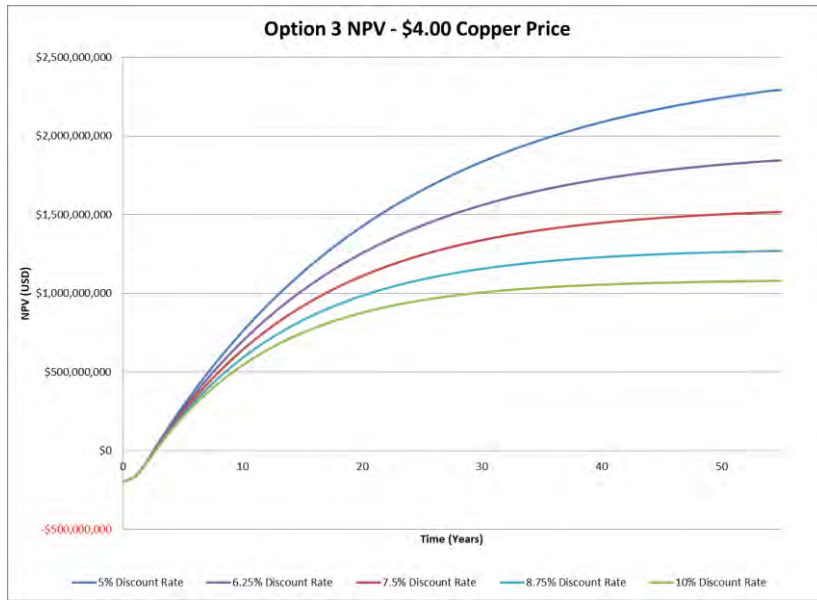

## 25.7 Economic Outcomes – Option 4

The economic outcomes of the 20 Mtpa with 80% copper recovery producing LME copper and copper sulfate scenario are summarised in Table 25-5.

**Table 25-5: Option 4 - Project Metrics**

20 Mtpa @ 80% Cu Recovery + CuSO <sub>4</sub>									
LME Cu, tpa	35,332.3								
CuSO <sub>4</sub> .5H <sub>2</sub> O, tpa	51,080.9								
CAPEX, USD	\$340,788,964								
Processing OPEX, USD/year	\$90,799,289								
<b>Copper Price, USD/lb</b>	<b>\$2.00</b>	<b>\$2.25</b>	<b>\$2.50</b>	<b>\$2.85</b>	<b>\$3.00</b>	<b>\$3.25</b>	<b>\$3.50</b>	<b>\$3.75</b>	<b>\$4.00</b>
Avg. Annual Revenue LME Cu (USD/year)	\$155,788,428	\$175,261,982	\$194,735,536	\$221,998,511	\$233,682,643	\$253,156,196	\$272,629,750	\$292,103,303	\$311,576,857
Avg. Annual Revenue CuSO <sub>4</sub> (USD/year)	\$71,677,731	\$80,637,447	\$89,597,163	\$102,140,766	\$107,516,596	\$116,476,313	\$125,436,029	\$134,395,745	\$143,355,462
Total Cost, USD/t ROM	\$7.56	\$7.60	\$7.64	\$7.70	\$7.73	\$7.77	\$7.81	\$7.86	\$7.90
Total Cost, USD/lb CuEq	\$1.33	\$1.34	\$1.34	\$1.35	\$1.36	\$1.37	\$1.37	\$1.38	\$1.39
NPV <sub>7.5%,pre-tax</sub>	\$424,332,976	\$700,822,163	\$977,311,350	\$1,364,396,212	\$1,530,289,724	\$1,806,778,912	\$2,083,268,099	\$2,359,757,286	\$2,636,246,473
IRR <sub>pre-tax</sub>	18.6%	24.6%	30.1%	37.3%	40.2%	44.9%	49.4%	53.8%	58.1%
Payback Period <sub>pre-tax</sub>	6.91	5.21	4.22	3.38	3.13	2.8	2.5	2.3	2.2
NPV <sub>7.5%,post-tax</sub>	\$119,122,442	\$438,687,774	\$611,493,516	\$853,421,554	\$957,105,000	\$1,129,910,742	\$1,302,716,483	\$1,475,522,225	\$1,648,327,967
IRR <sub>post-tax</sub>	14.9%	18.9%	22.7%	27.6%	29.7%	32.9%	36.1%	39.2%	42.1%
Payback Period <sub>post-tax</sub>	8.87	6.94	5.71	4.59	4.23	3.8	3.4	3.1	2.8
Strip Ratio	1.41:1								
LOM, years	24								

**Figure 25-4: Option 4 NPV and Sensitivity Results**

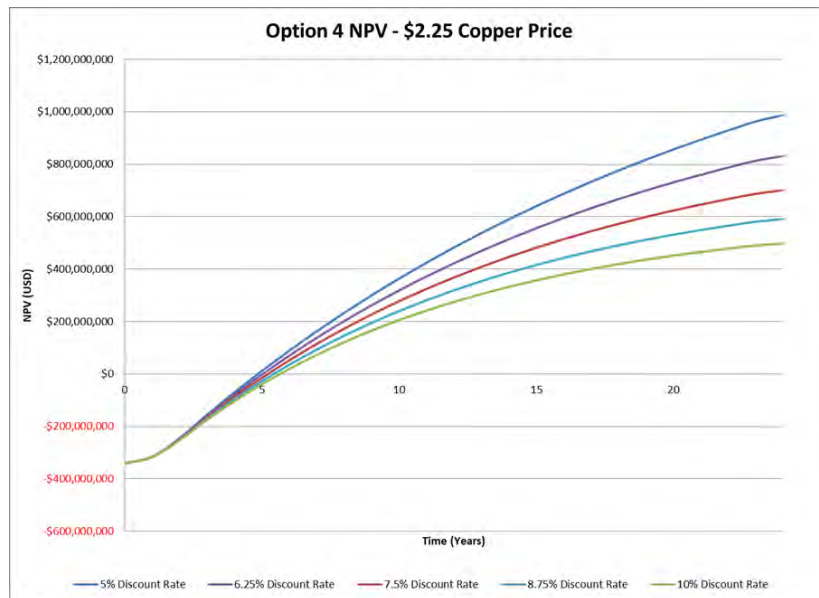
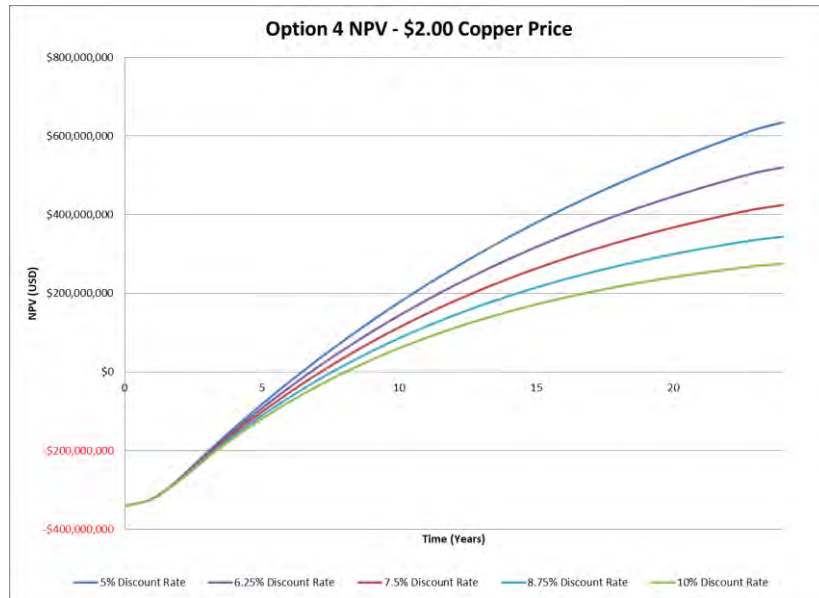

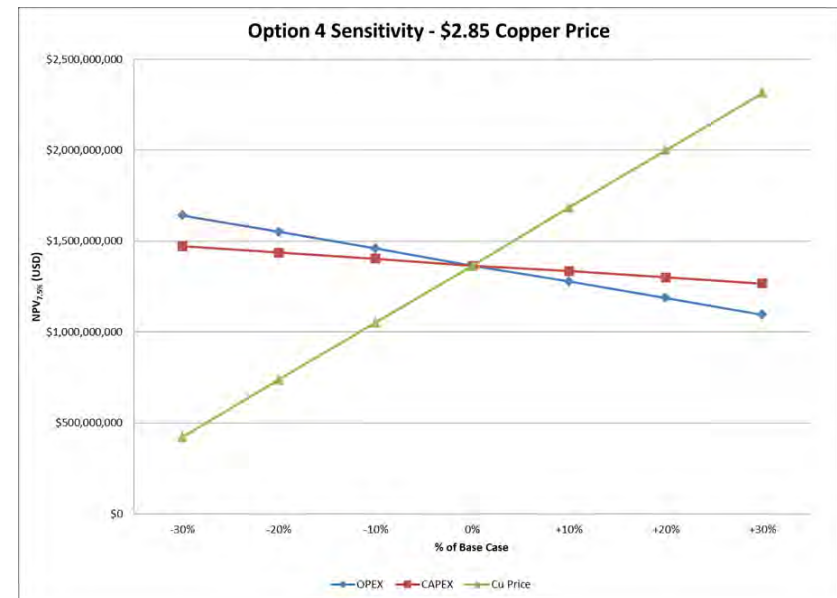
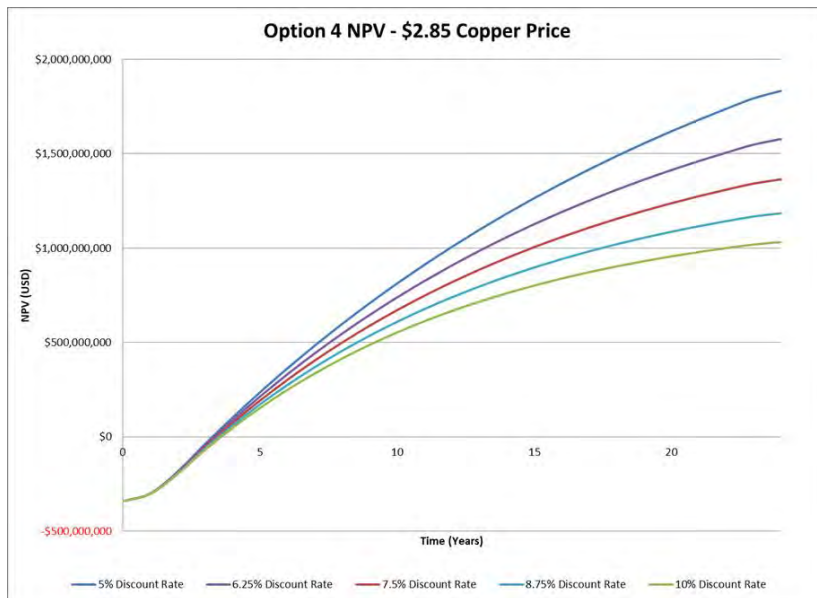
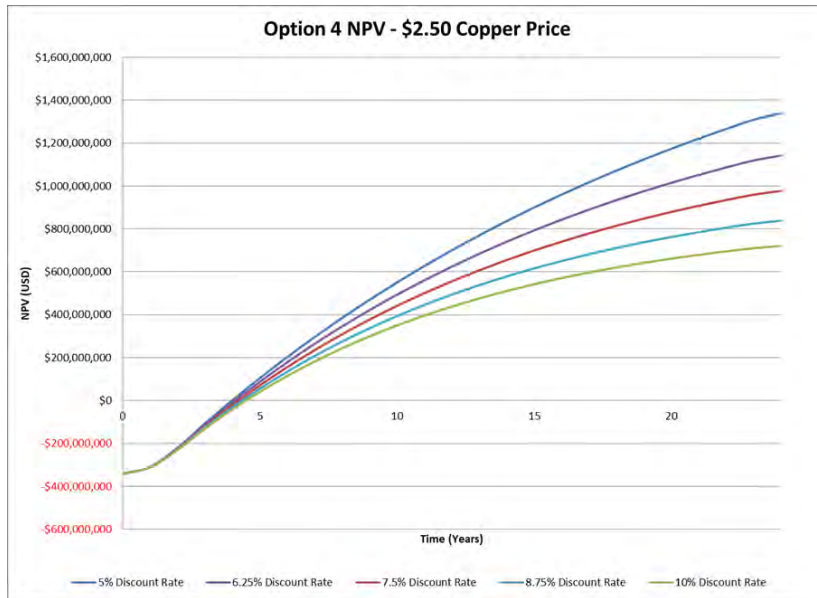

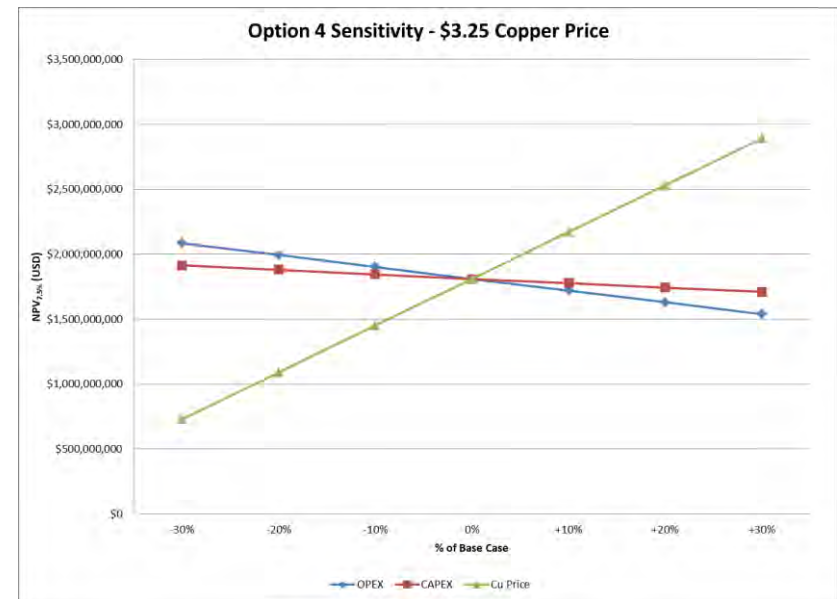
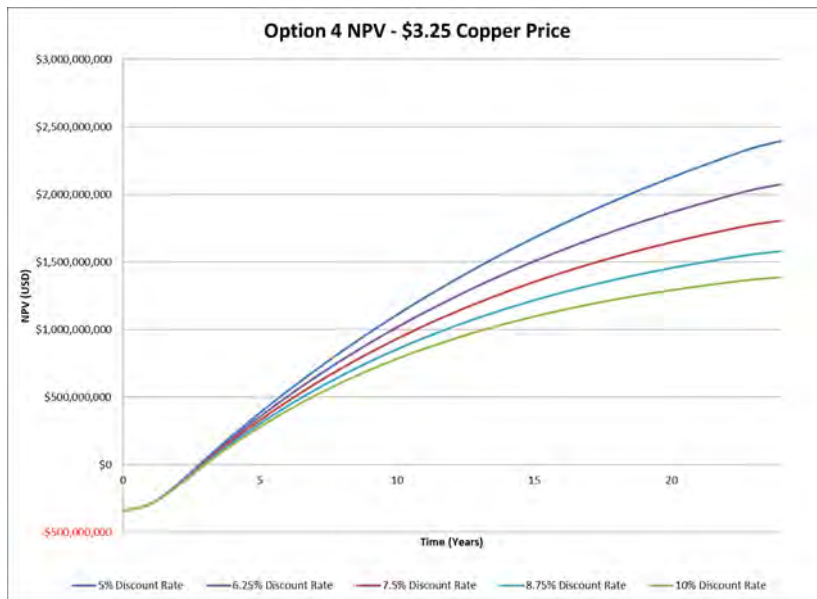
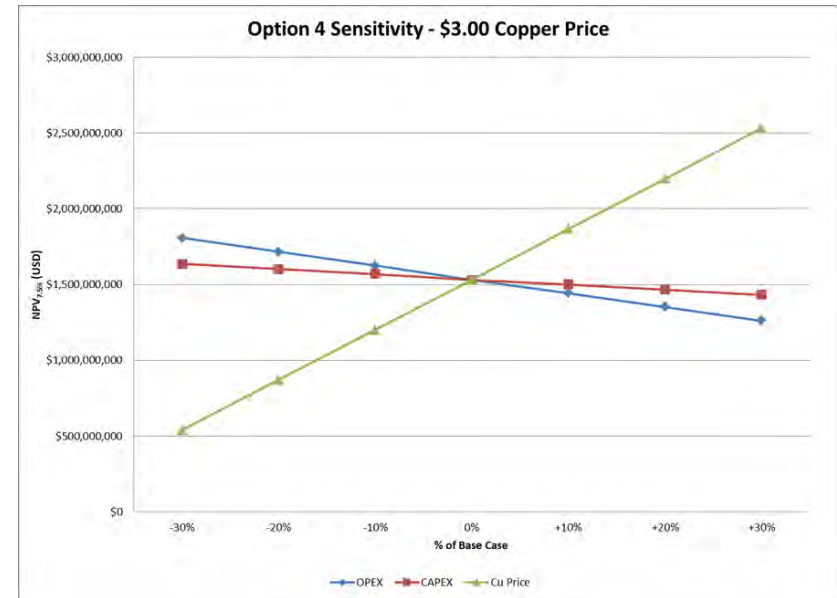
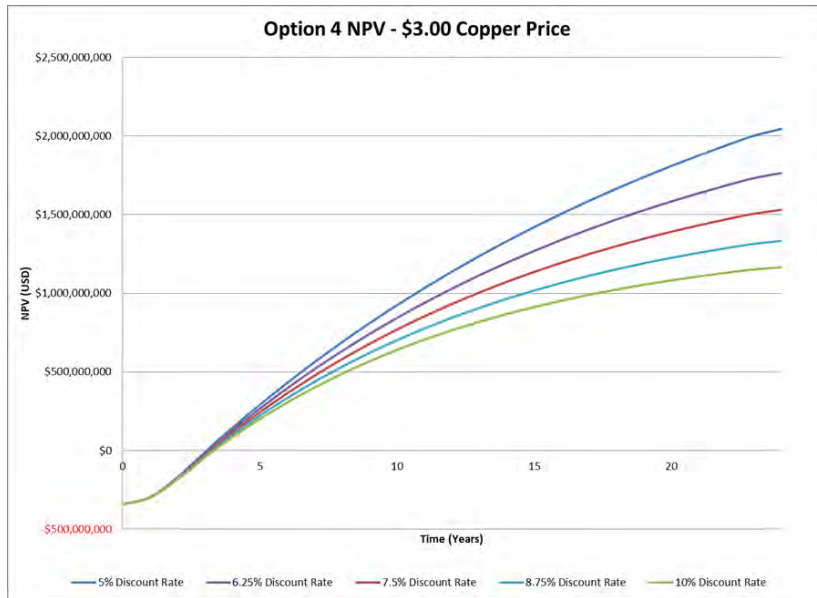

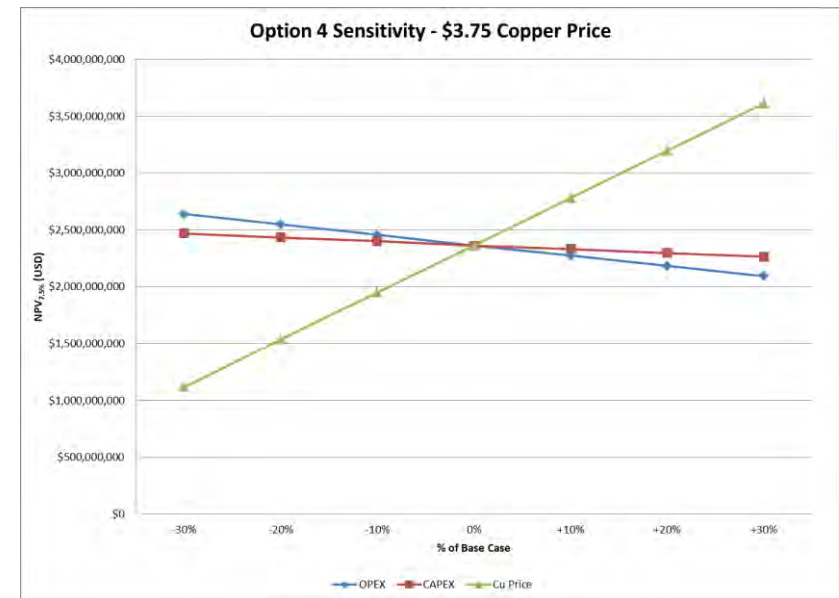
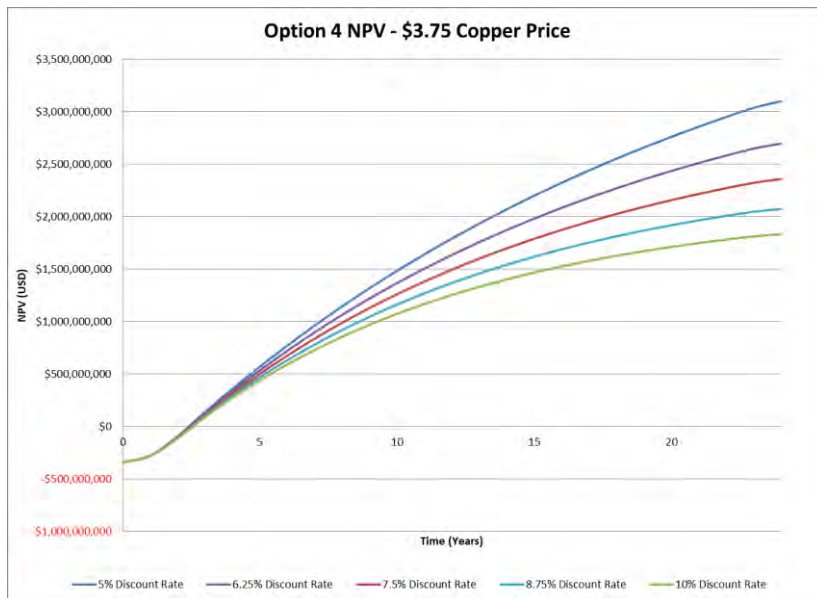
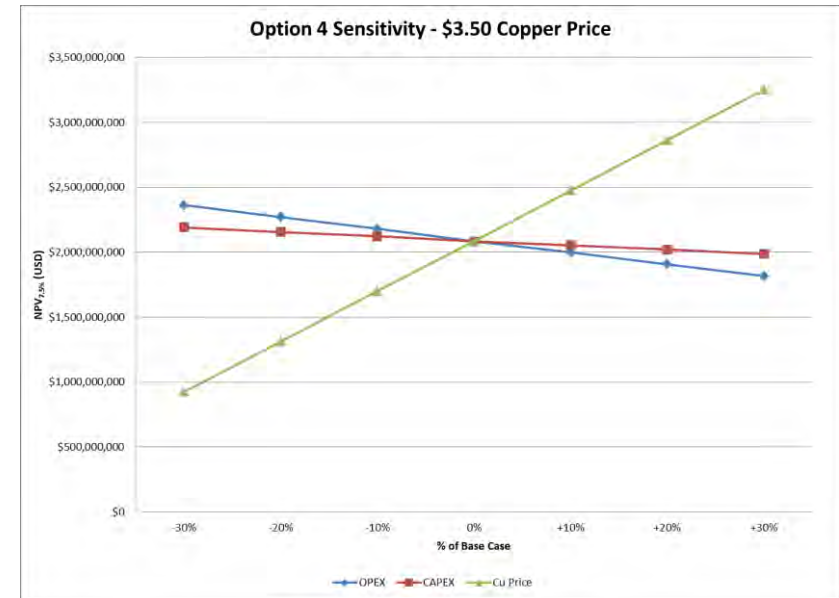
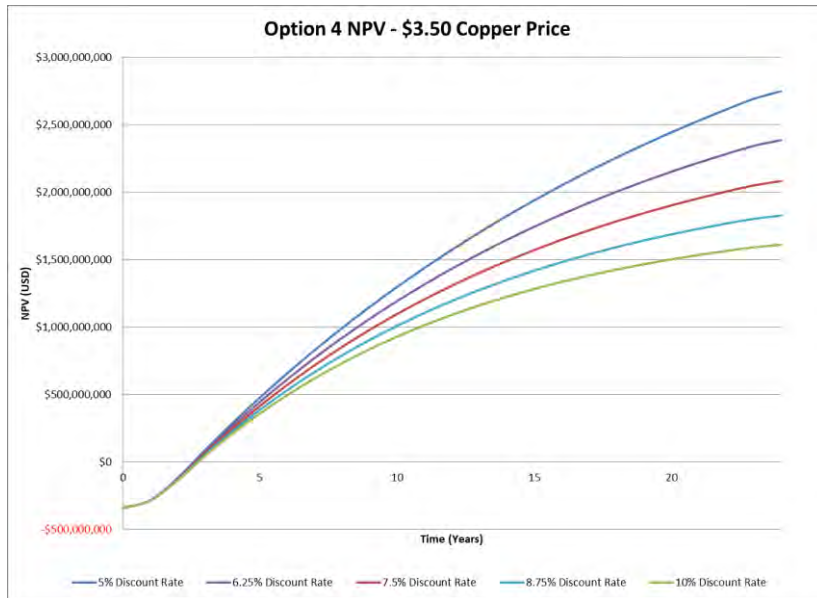

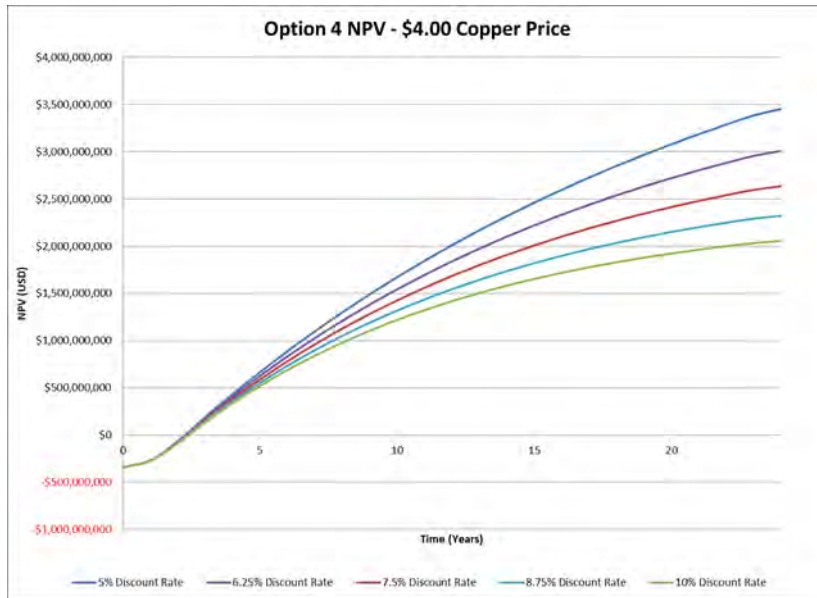



## 25.8 Economic Outcomes – Option 5

The economic outcomes of the 20 Mtpa with 85% copper recovery producing LME copper only scenario are summarised in Table 25-6.

**Table 25-6: Option 5 - Project Metrics**

20 Mtpa @ 85% Cu Recovery									
LME Cu, tpa	51,077.3								
CAPEX, USD	\$339,601,971								
Processing OPEX, USD/year	\$87,054,475								
<b>Copper Price, USD/lb</b>	<b>\$2.00</b>	<b>\$2.25</b>	<b>\$2.50</b>	<b>\$2.85</b>	<b>\$3.00</b>	<b>\$3.25</b>	<b>\$3.50</b>	<b>\$3.75</b>	<b>\$4.00</b>
Avg. Annual Revenue LME Cu (USD/year)	\$225,212,094	\$253,363,606	\$281,515,117	\$320,927,234	\$337,818,141	\$365,969,652	\$394,121,164	\$422,272,676	\$450,424,188
Total Cost, USD/t ROM	\$7.28	\$7.32	\$7.36	\$7.42	\$7.45	\$7.49	\$7.53	\$7.57	\$7.62
Total Cost, USD/lb CuEq	\$1.29	\$1.30	\$1.31	\$1.32	\$1.32	\$1.33	\$1.34	\$1.35	\$1.35
NPV <sub>7.5%,pre-tax</sub>	\$458,854,343	\$732,603,673	\$1,006,353,003	\$1,389,602,066	\$1,553,851,664	\$1,827,600,994	\$2,101,350,324	\$2,375,099,654	\$2,648,848,984
IRR <sub>pre-tax</sub>	19.4%	25.3%	30.7%	37.8%	40.7%	45.3%	49.8%	54.2%	58.4%
Payback Period <sub>pre-tax</sub>	6.63	5.06	4.14	3.33	3.09	2.8	2.5	2.3	2.1
NPV <sub>7.5%,post-tax</sub>	\$119,122,442	\$458,548,870	\$629,642,202	\$869,172,865	\$971,828,864	\$1,142,922,196	\$1,314,015,527	\$1,485,108,858	\$1,656,202,190
IRR <sub>post-tax</sub>	15.4%	19.4%	23.1%	28.0%	30.0%	33.2%	36.4%	39.4%	42.4%
Payback Period <sub>post-tax</sub>	8.56	6.76	5.59	4.52	4.18	3.7	3.3	3.0	2.8
Strip Ratio	1.41:1								
LOM, years	24								

**Figure 25-5: Option 5 NPV and Sensitivity Results**

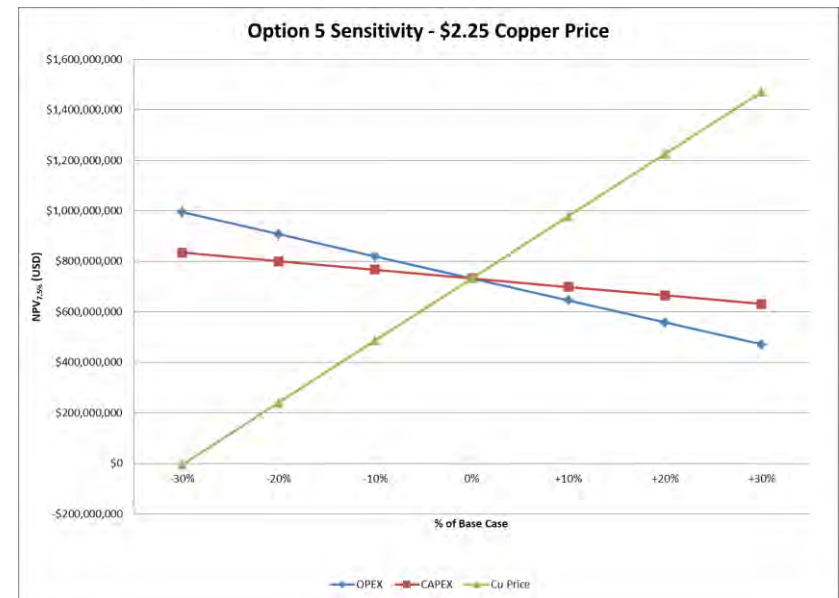
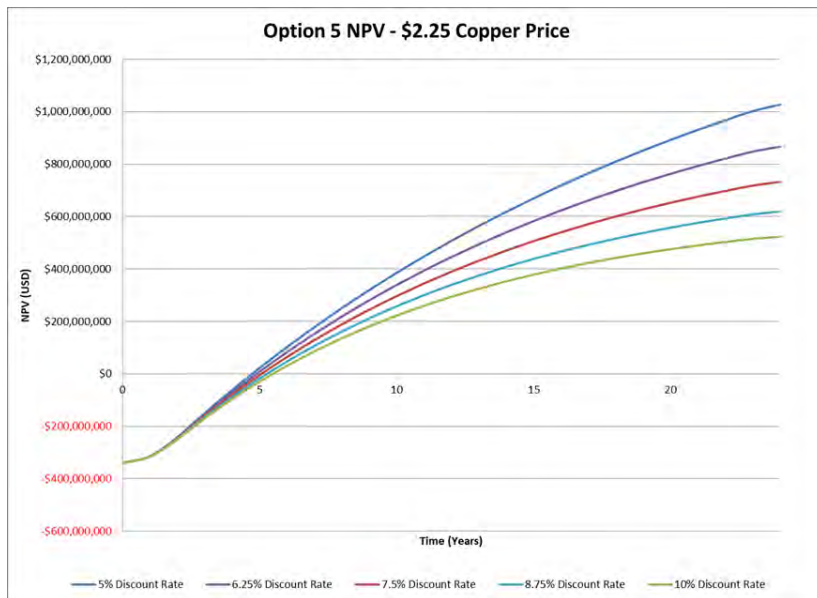
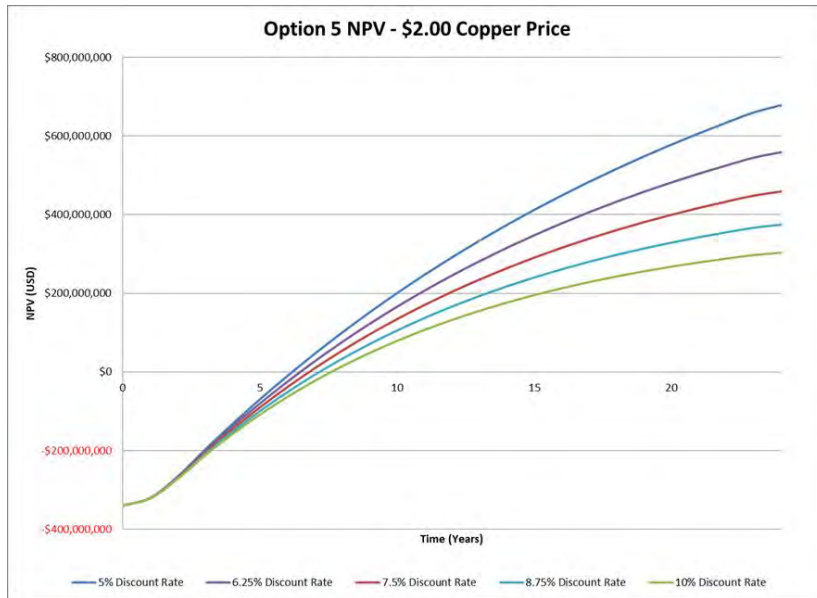

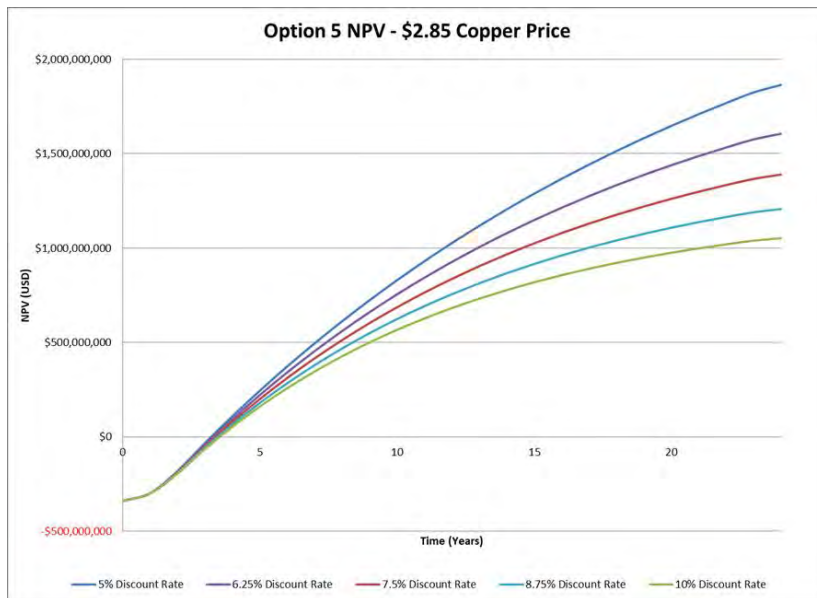
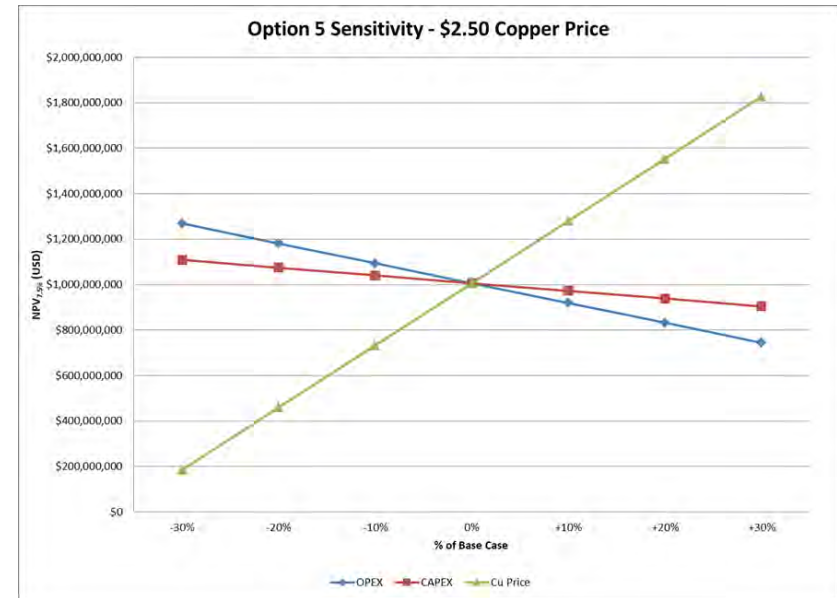
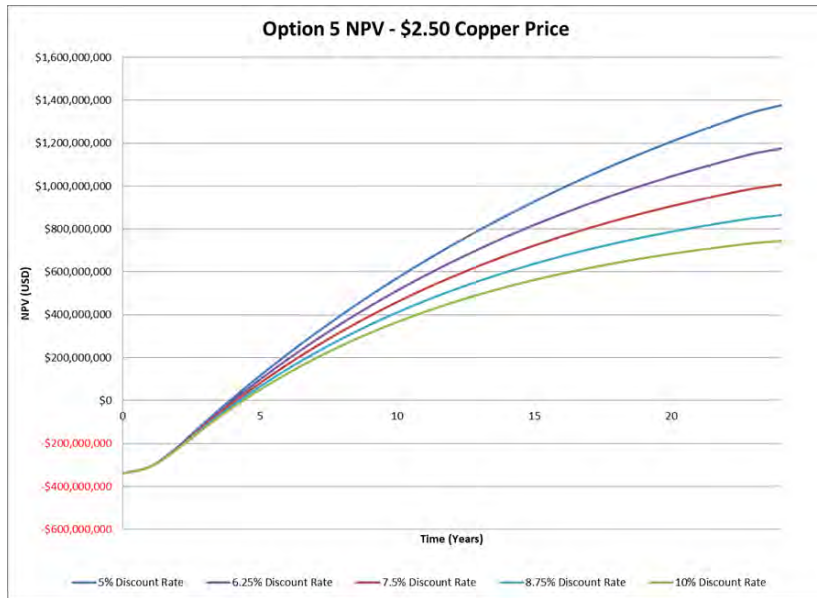

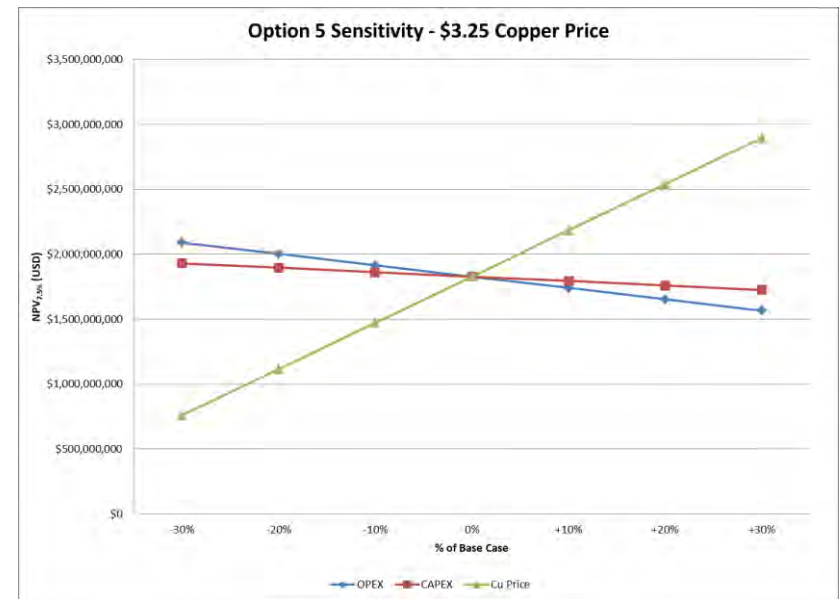
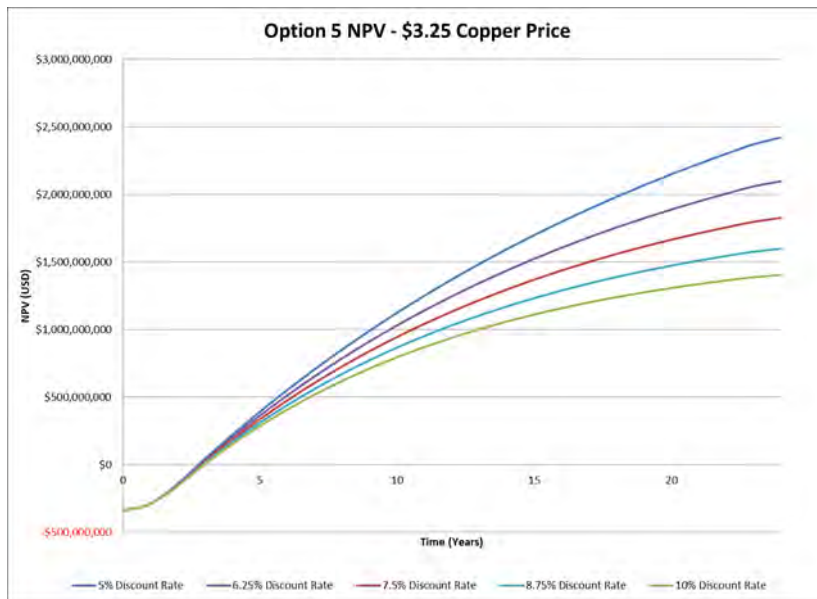
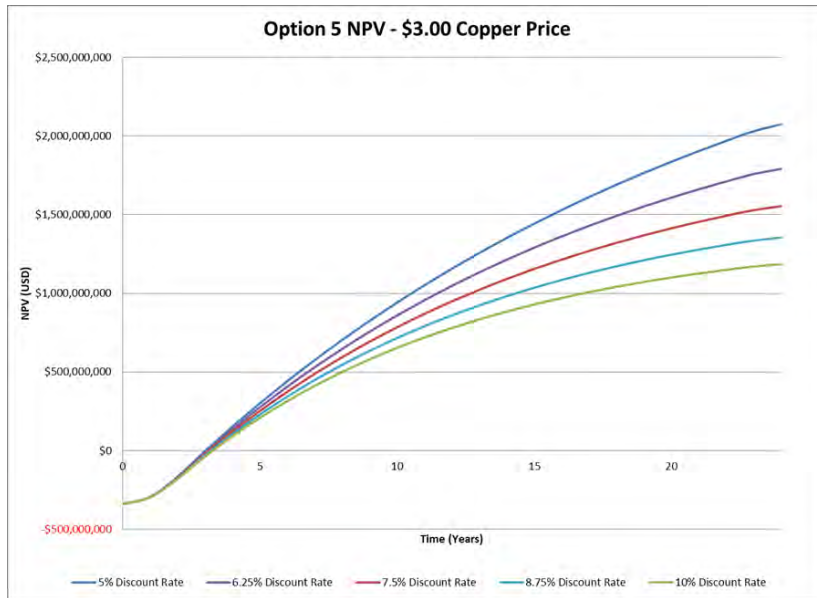

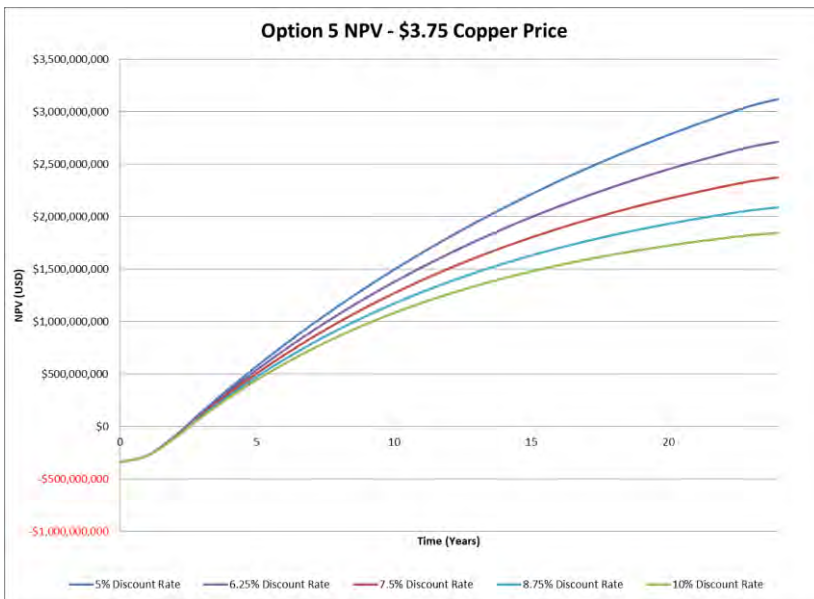
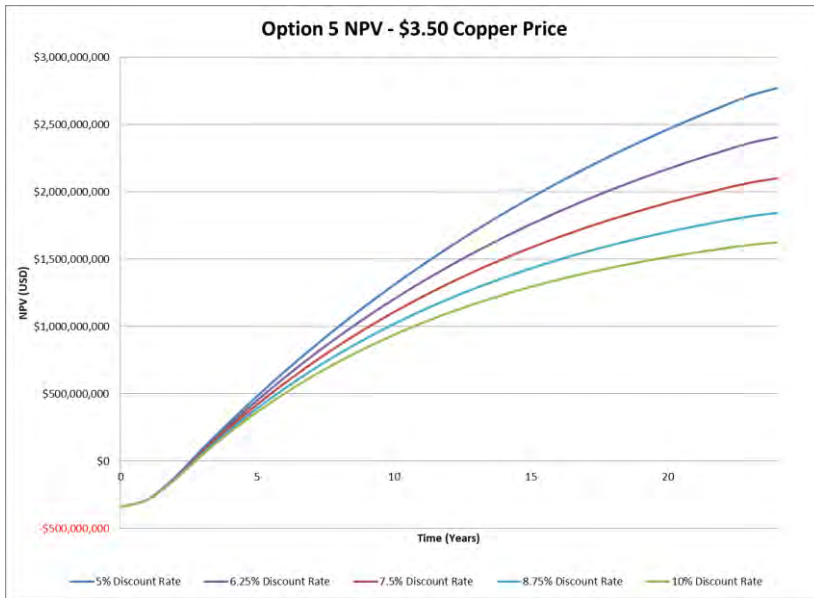

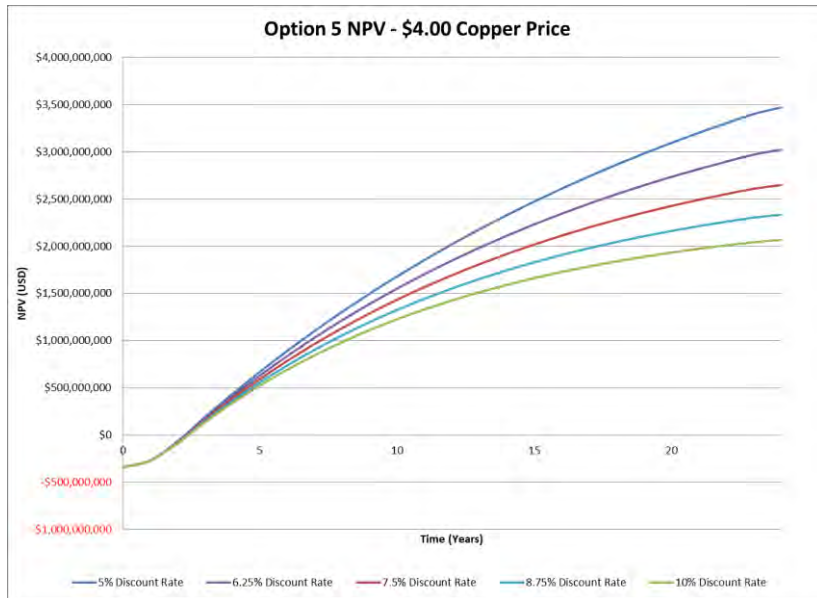

## 25.9 Economic Outcomes – Option 6

The economic outcomes of the 20 Mtpa with 85% copper recovery producing LME copper and copper sulfate scenario are summarised in Table 25-7.

**Table 25-7: Option 6 - Project Metrics**

20 Mtpa @ 85% Cu Recovery + CuSO <sub>4</sub>									
LME Cu, tpa	38,336.8								
CuSO <sub>4</sub> .5H <sub>2</sub> O, tpa	51,080.9								
CAPEX, USD	\$341,410,261								
Processing OPEX, USD/year	\$95,585,262								
<b>Copper Price, USD/lb</b>	<b>\$2.00</b>	<b>\$2.25</b>	<b>\$2.50</b>	<b>\$2.85</b>	<b>\$3.00</b>	<b>\$3.25</b>	<b>\$3.50</b>	<b>\$3.75</b>	<b>\$4.00</b>
Avg. Annual Revenue LME Cu (USD/year)	\$169,036,199	\$190,165,724	\$211,295,249	\$240,876,584	\$253,554,298	\$274,683,823	\$295,813,348	\$316,942,873	\$338,072,398
Avg. Annual Revenue CuSO <sub>4</sub> (USD/year)	\$71,677,731	\$80,637,447	\$89,597,163	\$102,140,766	\$107,516,596	\$116,476,313	\$125,436,029	\$134,395,745	\$143,355,462
Total Cost, USD/t ROM	\$7.82	\$7.87	\$7.91	\$7.98	\$8.00	\$8.05	\$8.09	\$8.14	\$8.18
Total Cost, USD/lb CuEq	\$1.30	\$1.31	\$1.32	\$1.33	\$1.33	\$1.34	\$1.35	\$1.35	\$1.36
NPV <sub>7.5%,pre-tax</sub>	\$503,050,025	\$795,642,115	\$1,088,234,204	\$1,497,863,129	\$1,673,418,382	\$1,966,010,471	\$2,258,602,561	\$2,551,194,650	\$2,843,786,739
IRR <sub>pre-tax</sub>	20.4%	26.5%	32.2%	39.6%	42.6%	47.5%	52.2%	56.7%	61.1%
Payback Period <sub>pre-tax</sub>	6.32	4.83	3.94	3.18	2.94	2.6	2.4	2.2	2.0
NPV <sub>7.5%,post-tax</sub>	\$119,122,442	\$497,951,472	\$680,821,528	\$936,839,606	\$1,046,561,639	\$1,229,431,695	\$1,412,301,751	\$1,595,171,807	\$1,778,041,862
IRR <sub>post-tax</sub>	16.0%	20.2%	24.1%	29.2%	31.3%	34.7%	38.0%	41.2%	44.3%
Payback Period <sub>post-tax</sub>	8.22	6.47	5.34	4.30	3.98	3.5	3.2	2.9	2.7
Strip Ratio	1.41:1								
LOM, years	24								

**Figure 25-6: Option 6 NPV and Sensitivity Results**

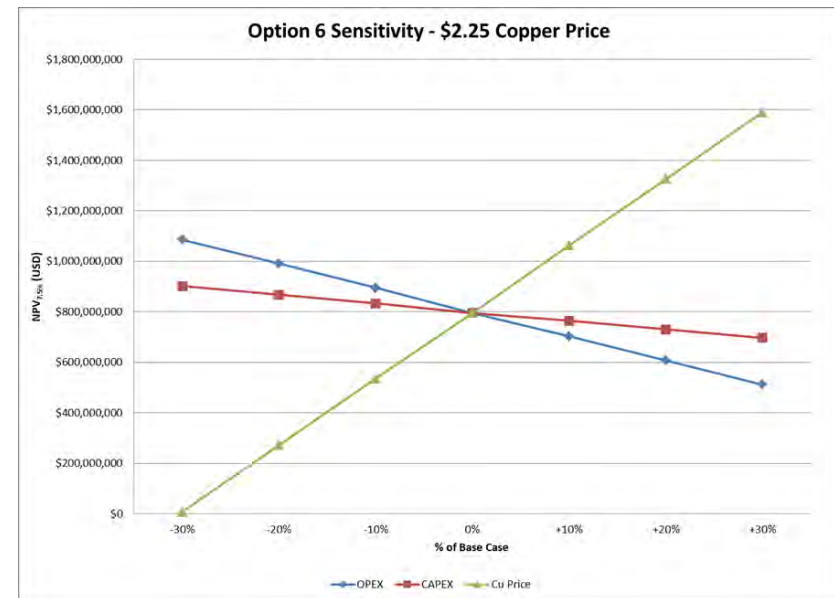
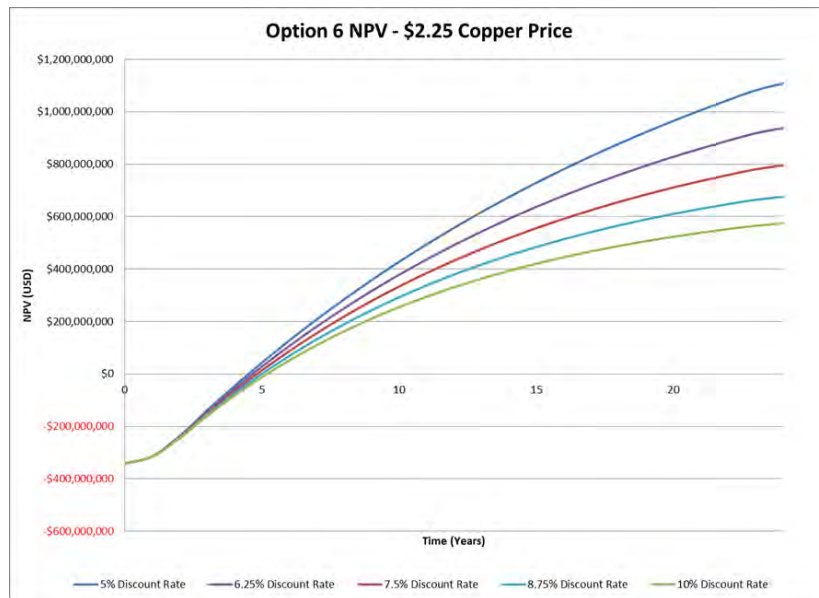
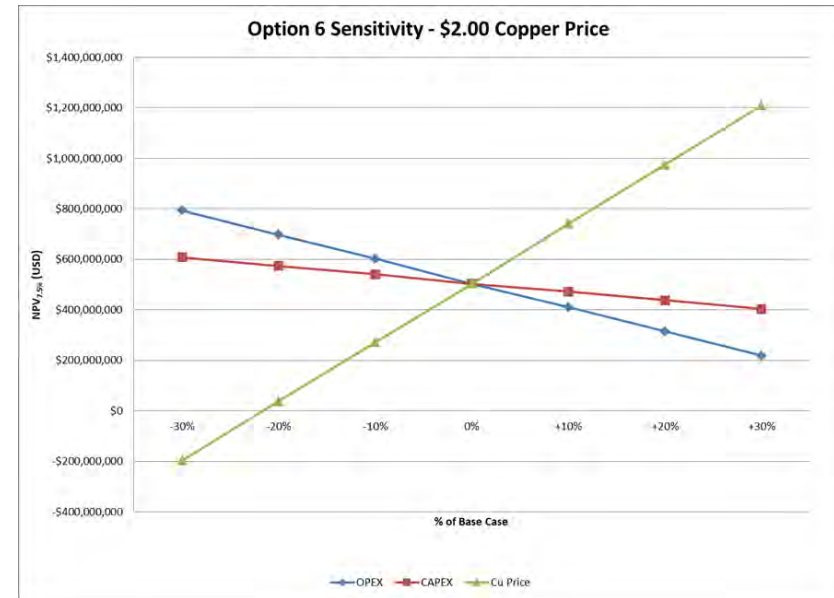
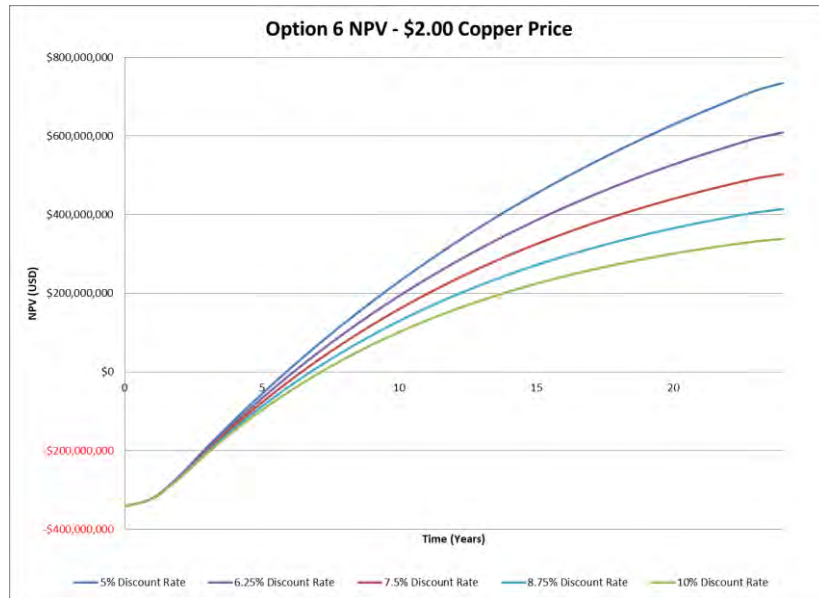



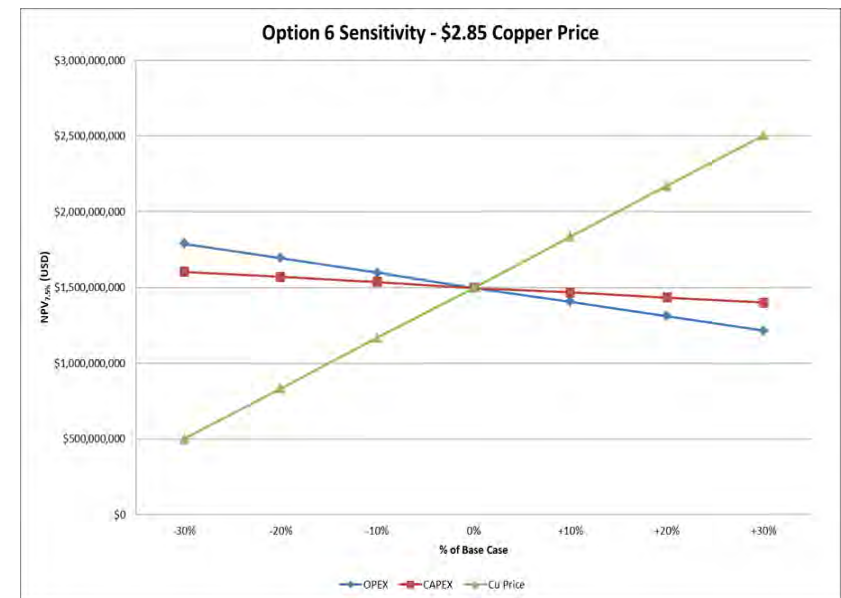
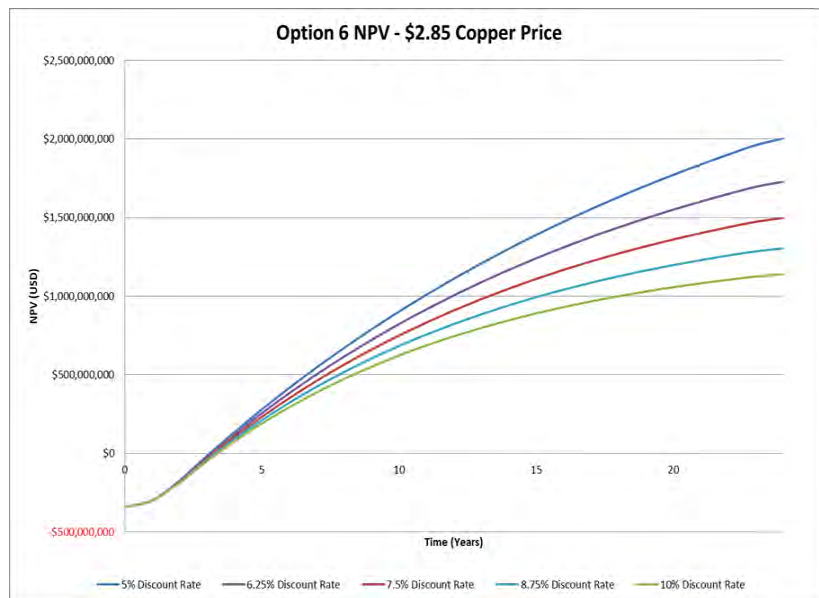
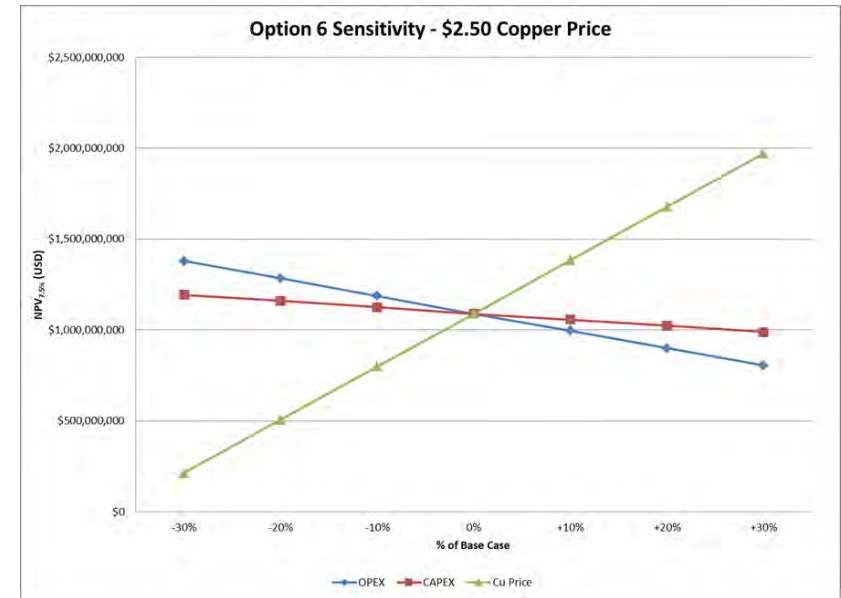
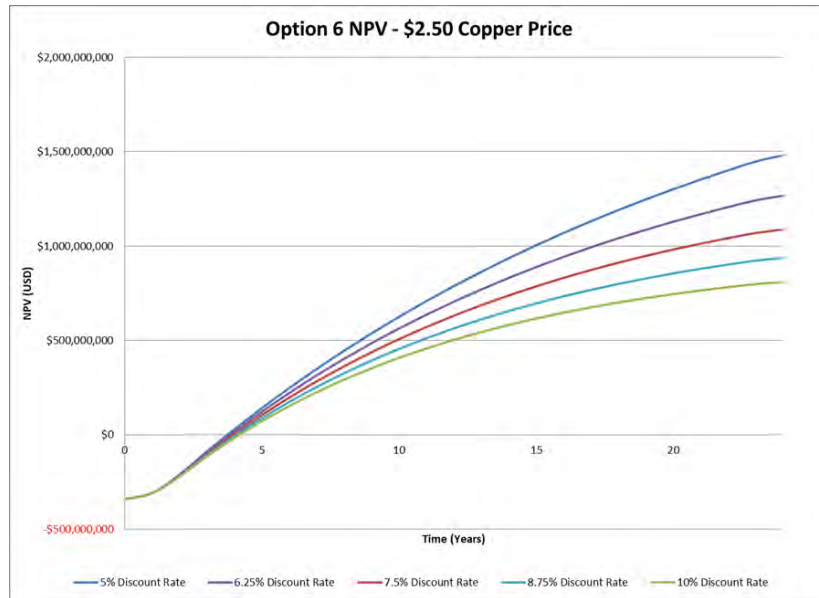

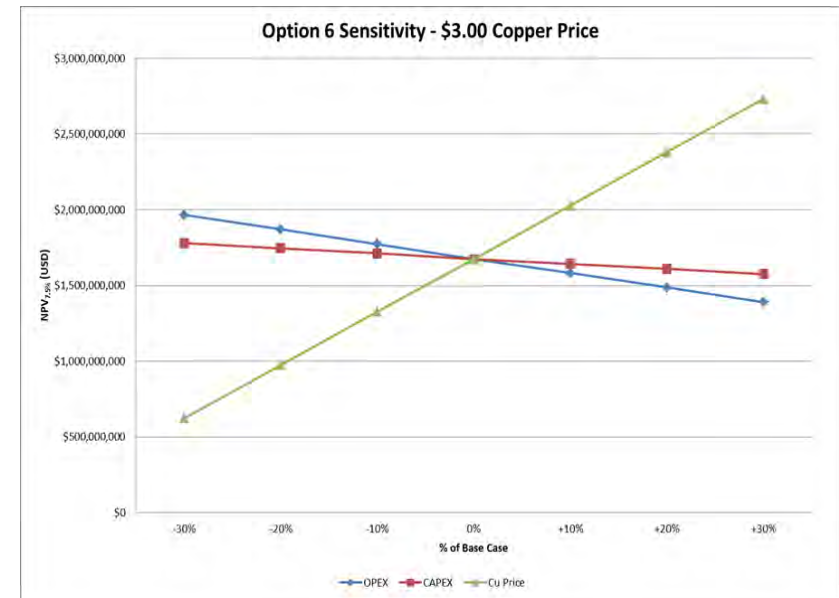

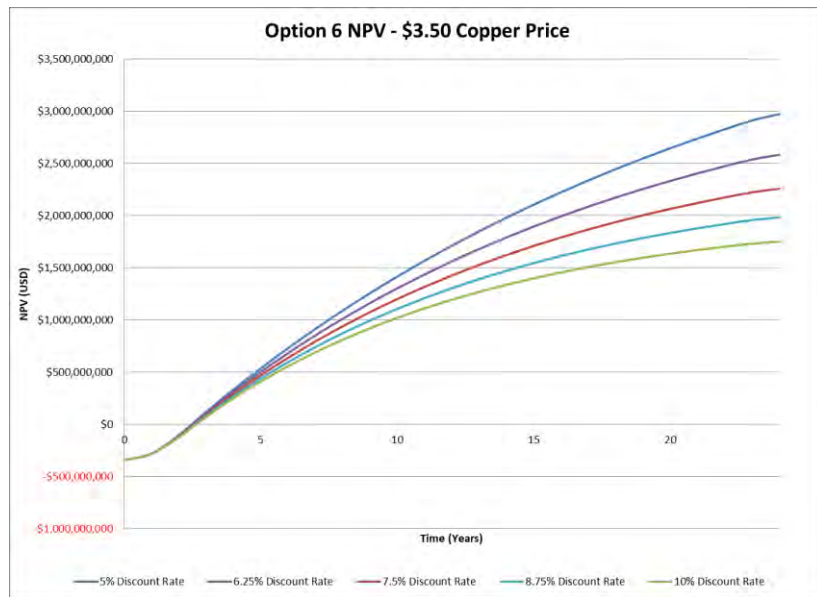
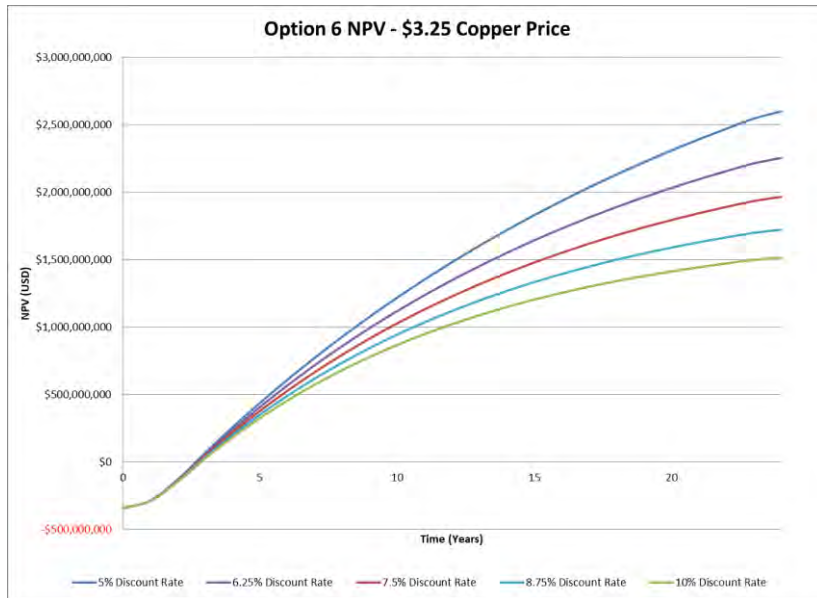

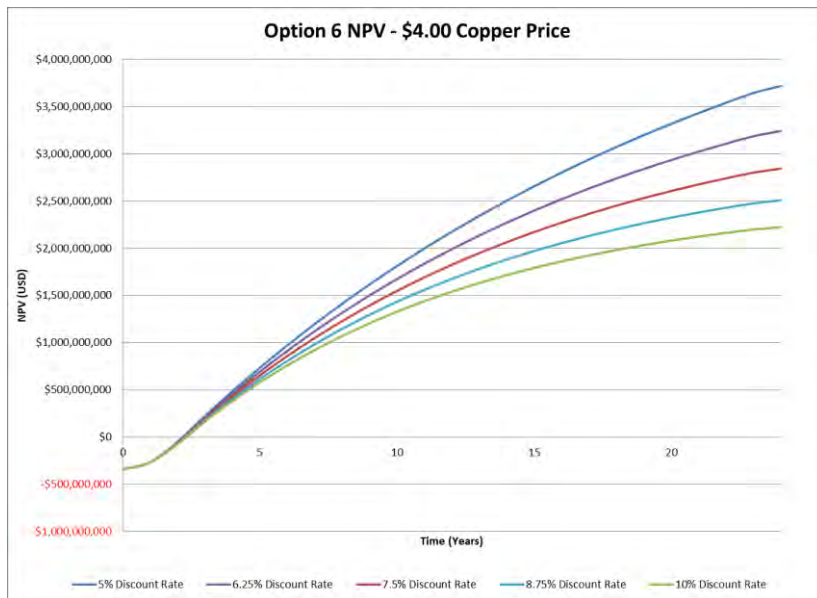
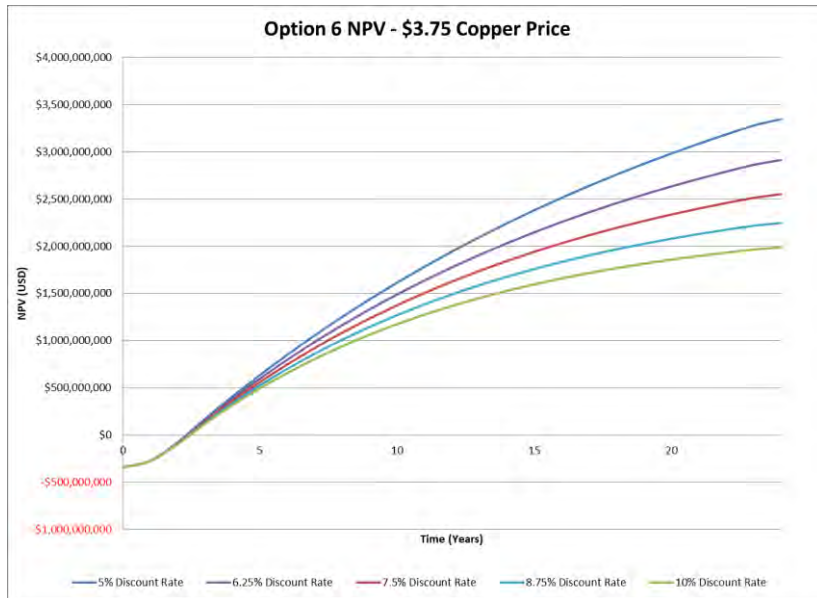

## 25.10 Economic Opportunity

Based on the current testwork programme, the low-grade pyrite bearing ore will generate a significant amount of sulfuric acid during the heap leaching process. As a result, the acid requirement for the plant has been reduced which resulted in the removal of the sulfur burning plant for both the 8.5 Mtpa and 20 Mtpa scenarios. The cost of sulfuric acid has been estimated at a cost of US\$ 275 per tonne DPA to Noordoewer according to quotations received. There are opportunities of reducing the sulfuric acid cost such as sourcing acid from local smelters and off-gas cleaning facility. Alternatively, the option of including a sulfur burning plant can still be considered as it reduces the reagent costs and generates power for producing sulfuric acid. There will also be waste heat for heating the heap solutions.

The limestone cost has been estimated at a cost of US\$150 per tonne which is very expensive as it is sourced internationally. The project economics can be improved if limestone can be sourced from local resources.

## 25.11 Project Viability

Based on the findings of the economic analysis, the Haib project has significant potential to be a great project. Modern processing technology can be used to assist in maximising the economic potential of such a large resource. Testwork validation would be required, although from the assumptions used, the Haib project is economically viable.

## 26. RISK ASSESSMENT

### 26.1 Risks

Risk is defined in the Australian Standard on Risk Management (AS/NZS 4360:1995), as “the chance of something happening that will have an impact on objectives”.

Risk has two characteristics that need to be understood to be managed. They are:

1. It has a focus on future events, therefore it deals with *uncertainty*.
2. It generally focuses on *unfavourable events*, although the process can be used to identify opportunities.

Risk has two dimensions that need to be jointly assessed to determine the magnitude of risk. They are *likelihood* and *consequence*:

1. *Likelihood* refers to the possibility that a particular event will (or won't) occur. It is a general term, which applies to *probability* or *frequency*.
2. *Consequence* refers to the extent to which a given event has an adverse impact on objectives. It is also referred to as *severity* and the two terms are interchangeable. Consequences can be expressed quantitatively (High or \$2M)

Risk management is a structured approach to managing risks. The standard defines risk as “the systematic application of management policies, procedures and practises to the tasks of identifying, analysing, assessing, treating and monitoring risks.”

Risk management process can be applied to resource projects as an essential part of good business management practice.

### 26.2 Haib Risk Assessment Process

We have focussed on events, which will happen in the future and therefore have an uncertain or unpredictable outcome. The extent to which an event is predictable is dependent on a number of factors including its uniqueness, the amount of information available from previous similar events and the degree of correlation between the event and other predictable or measured factors.

Resource projects by their very nature are unique; therefore there is a high degree of uncertainty about whether or not the project objectives will be achieved. Even though the unit processes within the project are relatively predictable and not new technology, the relationship between the processes and interlinking is such that the outcome is less certain.

### 26.3 Establish the Context of the Review

This was an important step because it determined the scope of the review and the extent of the risk management study.

The scope included the mining, process, infrastructure and planning, power supply and transmission, water and tailings, financial analysis, project schedule and environmental management.

### 26.4 Identify the Risks

The analysis looked at each unit process step for the project and based on the information provided and our own experience we have identified all possible events that could impact on the project. We have also used discussions with the client, reviewed the laboratory reports, creative thinking techniques and internal discussions with colleagues to ensure we have captured all of the likely events.

### 26.5 Analyse the Risks

This involved assessing the likelihood of the identified risk events. The analysis was then quantitatively or qualitatively assessed to provide the information and determine probabilities the main purpose being to rank risk rather than assign a value.

### 26.6 Prioritise the Risks

This has been achieved by ranking the risks in each area and sorting the ranking from the highest to the lowest. This is necessary because with limited resources the major effort must be put into addressing the highest risk area (Pareto principle 80/20 rule).

### 26.7 Haib Risk Table

The risk matrix used for the Haib project is shown in Table 26-1

**Table 26-1: Subjective ranking matrix**

		Consequence		
		Low	Moderate	High
Likelihood	Low	Low	Low/moderate	Moderate
	Moderate	Low/moderate	Moderate	Moderate/High

	<b>Consequence</b>		
<b>High</b>	<i>Moderate</i>	<i>Moderate/High</i>	<i>High</i>

## 26.8 Risks Identified

The major risks identified are detailed in the following list and Table 26-2.

1. Insufficient metallurgical testwork has been undertaken. It is anticipated that the following testwork will be required:
  - Comminution on representative samples
  - Close circuit column leach tests on representative samples
  - Acid generation tests of low grade ore
  - Geotechnical tests to confirm the stacking height of the heaps
  - Variability testing
2. Trade off studies are required regarding purchasing sulfur and making acid on site or purchasing sulfuric acid.
3. The optimum port and infrastructure needs further study work.
4. Variability within the deposit.
5. Optimised transport routes.
6. Limited work was done for mining. This will be fully addressed in the Feasibility Study.



**Table 26-2: Risk register**

Item	Likelihood	Consequence	Current Risk	Discussion	Amelioration	Residual Risk
1	Moderate	High	Moderate /High	Current testwork does not reflect the entire proposed design	Perform testwork to validate process.	Moderate
2	Low	Moderate	Low/Moderate	There are several options for acid and possible shortfall in supply	Perform a study into possible suppliers and sulfur burning options.	Low/Moderate
3	Moderate	Moderate	Moderate	The Luderitz port may not have the facilities required to facilitate goods inward and outward	Ensure the Luderitz port is capable of handling the import and export goods. Assess the impact of using the Walvis Bay port.	Low/Moderate
4	Moderate	High	Moderate /High	Off specification product (very high dilution).	Extensive drilling and geometallurgy to be conducted.	Moderate
5	Low	Low	Low	Particularly for the mine-to-plant. If a conveyor is used will there be enough excess to allow for expansions.	Develop an expansion plan and build the conveyor accordingly.	Low
6	Moderate	Moderate	Moderate	Limited mining work was done leading to conservative mining design	Perform additional and appropriate mining work.	Low/Moderate

## 26.9 Opportunities

### 26.9.1 Solar Energy

Given the semi-arid climate of Namibia, a solar energy farm may be an option for reducing the unit cost of power. This will also have positive social impacts for the project, which is expected to have a long life.

### 26.9.2 Project Expansion

The vast resource tonnage allows for multiple expansion stages to be executed once in production. A staged approach is recommended in order to de-risk the project by ensuring the project achieves positive cash flow prior to plant expansions.

### **26.9.3 Optimisation**

During operation there should be ongoing optimisation studies to ensure the project financials are maximised. This should include optimisation of the metallurgy, recoveries, products and raw materials.

### **26.9.4 Sulfur Burning Plant**

There are several possibilities for sulfuric acid sourcing, including purchasing from smelters within Namibia. Tsumeb has an off-gas cleaning facility that produces sulfuric acid for sale. An alternative would be Vedanta Resources who have suggested producing and sending zinc concentrate from their Gamsberg zinc mine to Skorpion mine, which is located closer to the Haib site than the alternative options. Buying in sulfuric acid at the start of the project life and building a sulfur burning plant once the project is cash flow positive may provide a better economic scenario. This will allow for the sulfur burning plant capital to be deferred and the payback period to be shortened. This trade-off study will have to be completed once accurate sulfuric acid pricing and the source of the acid have been obtained.

## **27. PROJECT IMPLEMENTATION**

### **27.1 Project Execution**

#### **27.1.1 Introduction**

A Feasibility Study (FS) would follow based on the best option.

A range of project implementation strategies is available for the execution of capital projects. They include, most commonly, EPCM delivery and EPC delivery.

EPCM (Engineering, Procurement and Construction Management) delivery is carried out on a reimbursable basis with provision of services by the EPCM Contractor for design, procurement, project management, construction management and commissioning. All purchase orders for equipment and materials, and contracts for major equipment and construction services, are tendered, adjudicated and awarded by the Contractor on the Client's behalf, such that the provider enters into an agreement with the Client's organisation, administered on its behalf by the Contractor. Under this model, the Client is underwriting the cost and time-related risks on the project, albeit that the management of these risks is carried out by the Contractor. It is quite common in EPCM-type arrangements for the Contractor to offer performance warranties, thus relieving the Client of the technical risk associated with the design itself.

Where EPC delivery is adopted, the EPC Contractor undertakes the cost and time-related risks via a fixed-price agreement for delivery to a target timeframe. The pricing for EPC delivery would normally reflect provisions or allowances within the fixed price for the risks which are being transferred from the Owner to the Contractor. All purchases and contracts under an EPC delivery model will be between the Contractor and its providers. The Client has only one entity with whom it has a relationship for delivery of the total project (with minor exceptions perhaps for peripheral scopes of work or services), namely the EPC Contractor, with which most liabilities rest. It is critical for effective EPC delivery to have the project scope, targets and risks clearly defined prior to commencement. These are priced in the fixed-price agreement and subject to change only by commercial agreement.

In some instances, a reimbursable EPCM model is adopted whereby the Contractor assumes some exposure to specific risks, via incentives and penalties applied to its EPCM fee.

A Client's decision on the optimum strategy for its particular organisation and project will be influenced by consideration of:

- The risks associated with the project and its delivery

- The appetite within the organisation for the risks peculiar to the project, including technical challenges, location, timing, market conditions, financing, intellectual property, logistics, political and social aspects, etc.
- The capacity of the Client organisation to manage and mitigate these risks in-house.

This Implementation Plan for the Haib Project assumes that the project will proceed on an EPCM basis, and that all project management, design and procurement work will be carried out in the EPCM Contractor's office, with the EPCM Contractor managing other consultants, suppliers and contractors as necessary.

The FS Implementation Plan contemplated a staged project delivery comprising:

### **27.1.2 Project objectives**

The primary objectives of the Haib Project are:

- Zero harm to all personnel involved with the construction of the Project and the operation and maintenance of the facilities
- Zero avoidable environmental impact and zero environmental incidents
- Meeting or exceeding Brockman's health, safety, environmental, community relations, quality and Project development standards
- Constructing an operating copper ore mining operation and processing plant with a design life of approximately 20 years
- Achieving a smooth and rapid ramp-up to full operating capacity with no ongoing operational issues in the form of abnormal maintenance and/or operating issues and costs due to substandard design and/or quality of construction
- Minimising delivered capital and operating costs
- Expediting the construction and staged commissioning processes
- Ensuring that there are no adverse human resources/industrial relations issues during the Project
- Providing a plant capable to achieve the agreed performance targets
- Maintaining effective control of project costs
- Delivering project outcomes in line with Brockman's expectations.

### **27.1.2.1 Engineering**

The EPCM Contractor will carry out the detailed design for the project, which will include the following:

- Detailed design and drafting for the project in the following disciplines:
  - Process
  - Mechanical
  - Civil and earthworks
  - Structural
  - Architectural
  - Piping
  - Electrical
  - Instrumentation
- Developing and maintaining specifications, lists and datasheets for mechanical and electrical equipment, piping and instruments
- Conducting calculations as required
- Developing technical specifications and standards for the project
- Coordinating design reviews and verification
- Tracking of deliverable status and document control
- Liaising with vendors and incorporating vendor data to the overall design
- Conducting HAZOPs and other risk and operability assessments
- Supporting client, supplier, contractor and construction needs with technical query resolution and field engineering support

### **27.1.3 Construction**

#### **27.1.3.1 General**

The EPCM Contractor will manage the construction activities on site, including responsibility for the co-ordination and management of interfaces between contractors and operations personnel.

The Construction Management Plan will typically address the following:

- Contractor mobilisation

- Contractor HSE plans
- Contractor reporting
- Client and Contractor site meetings
- Co-ordination with operations activities
- Co-ordination between contractors
- Quality Assurance on Brockman's behalf, including contractor and supplier non-conformance and concession request management
- Development of project Manufacturer Data Reports ('MDRs')
- Recording of as-built information
- Site technical queries and field engineering
- Site health, safety and environmental management, auditing and reporting
- Site industrial relations
- Periodic progress measure, claim verification and sign-off
- Coordination of emergency evacuation procedures
- Goods receipt and issuing to contractor care and custody

## **28. WAY FORWARD**

### **28.1 Feasibility Study**

The results from the scoping study have been promising. Going forward METS recommends Deep-South Resources move to conduct a Feasibility Study (FS) as the next phase of the project.

It is the objective of the Feasibility Study to complete all necessary work that is required in advance of the Basic Engineering Stage including evaluation of trade-off studies to determine the final project configuration. This is accomplished by completing and documenting the necessary trade-off studies with the objective to select a preferred project approach. The work under this section also includes, if required, the implementation of an optional pilot plant to prove the process. Upon completion of this stage, the project team will have completely defined the project parameters and business criteria such that the strategic plan for project completion and implementation is fixed.

### **28.2 Feasibility Requirements**

The Feasibility Study should be carried out in primary accordance with the Minimum Standard for the definition and evaluation of Projects including Policies and Procedures to affect a consistent approach through a stated level of evaluation techniques.

The Feasibility Study should achieve the following:

- Finalise technical and economic viability of the project
- Establish a single project configuration and investment case supported by the necessary project execution plan
- Measured and Indicated mineral resources
- Detailed mine production plan.
- Confirmed product specifications and marketing agreements.
- Fixed project scope and design criteria.
- Site grading preparation plan complete with quantity take-offs and bid prices.
- Detailed layouts, plans and sections of major facilities.
- Fixed price bids for all major equipment.
- Fixed price bids for infrastructure
- Orders placed for long lead-time equipment with cancellation clauses.
- Design of major structure steel quantities and bids for fabrication/supply.

- Major foundation design and quantity take-offs, including unit price bids for concrete supply.
- P&IDs and preliminary piping layouts for major process streams, piping specifications and preliminary quantity take-offs. Unit price bids where possible.
- Process control and instrumentation system cost estimate based on outline P&IDs and preliminary I/O count.
- Power supply and distribution system including main sub-station, site distribution single line diagrams, unit sub-stations, MCC's and electrical motor list.
- Power source, reticulation (to site) and availability.
- Layouts and capital cost estimates for all site infrastructure and support services such as sewage treatment, potable water treatment, fire protection, HVAC, offices, laboratories, gatehouse and security systems, site drainage, access roads and yard lighting, fencing, first aid clinics.
- Detailed project execution plan including the construction schedule procurement and expediting programs.
- Indirect cost estimate including construction camp, major construction equipment, construction power and water supply, construction lay down areas, construction receiving and warehouse facilities, construction drainage and environmental mitigation costs, construction logistics.
- Project procedures.
- Detailed resource strategy for construction and operations.
- Completed Environmental Impact Assessment.
- Established Environmental, Health and Safety monitoring and management systems.
- Detailed Risk assessments and mitigation plans.
- Detailed estimate of commissioning costs, operating costs, sustaining capital and closure costs within the target accuracy of  $\pm 15\%$ .
- Capital cost estimate with a target accuracy of  $\pm 15\%$ .
- Water source, water rights and availability.
- Housing and accommodation of staff.
- Social and labour plan
- Mine closure and rehabilitation (plan)



### **28.3 Resource Drilling**

This will include oriented infill drilling to achieve better definition of the high grade areas. Previous drilling was vertical holes but recent updates on the Geology indicate any new holes should be angle holes.

### **28.4 Metallurgical Testwork**

To improve confidence in the FS results more detailed metallurgical testwork will be required. Most work to date has focussed on the potential of processing options and is not sufficient to truly evaluate their feasibility with confidence.

#### **28.4.1 Drill Core**

Drill core should be used in the next stage of testwork. The use of drill core will minimise the risk of drilling methods significantly changing the properties of the test material, providing high quality sample for the tests described in the following.

#### **28.4.2 Column Leach Tests**

Column leach tests will be required for the FS to determine several key heap leaching parameters with higher accuracy than those used for the scoping study. Previous testwork was designed to test the amenability of the ore to leaching by sulfuric acid. The testwork revealed that copper can be leached from the ore, however the conditions did not accurately represent the conditions that will be experienced in a heap leach. In addition, the 2019/2020 testwork programme was carried out on samples of higher copper grade. The samples were coming from well preserved stockpile material that was extracted in the adit in the higher grade area. It is important to note that the sample head grade at 0.73% Cu is higher than the average grade of the resource estimation and it is not guaranteed that it is a representative sample of the overall deposit.

The results from a pilot scale heap leach operation will be required at a later stage of the project development to provide better sulfuric acid consumption and metal recovery data for the economic assessment.

Column leach tests are small scale laboratory tests designed to evaluate the amenability of an ore to heap leaching. Like a full scale heap leach, the ore is agglomerated, the agglomerated ore is placed in a column (avoiding packing of material) and a solution is percolated through the column with intermittent monitoring to determine acid consumption figures.

The PLS from the column leach tests can be used for solvent extraction testwork which will be required to determine the configuration of the copper solvent extraction circuit. Optimisation of leaching and stripping solutions is crucial to optimisation of the solvent extraction circuit.

Electrowinning tests can then be conducted on the strip liquor from solvent extraction in order to determine the cell operating conditions and the purity of the copper product to determine if changes are required to the solvent extraction configuration and operating conditions.

#### **28.4.3 Variability Testwork**

The 2019/2020 testwork performed on samples which is considered only representative for higher-grade (~1% Cu) zone in the Haib deposit. The average head grade of the sulfide ores across the Haib deposit is lower at ~0.31% Cu.

It is recommended that further drilling to be conducted to collect sample from different locations of the Haib deposit to collect samples with different head grades. Variability testwork should be performed on the samples to confirm the results.

### **28.5 Engineering**

Engineering design will be required at a sufficient level to evaluate the project within a  $\pm 15\%$  level of accuracy. Factors such as heap leach design will be critical to the success of the project and the design needs to be established early in the Feasibility Study. The engineering design from this stage of the project should also have enough detail to move into the detailed design of the project.

### **28.6 Geology and Mining Study**

Geotechnical, geology and mining study should be conducted during the Feasibility Study to assess in detail the feasibility of mining the ore for the Haib Project.

### **28.7 Marketing Study**

A market study should be completed during the Feasibility Study, looking at the industry, a current market analysis, competition, future market potential, potential buyers and sources of revenue and sales projections.

## **28.8 Environmental Assessments**

Environmental impact assessments will be required for obtaining approvals for initiation of the project if the Feasibility Study returns promising results.

## 29. REFERENCES

- Daniel, M. Lane, G. McLean, E. "Efficiency, Economics, Energy and Emissions –Emerging Criteria for Comminution Circuit Decision Making." IMPC. 2010
- De Oliveira, Debora M. Luis, Sobral G.S. Olson, Gregory J. Olson, Susan B." Acid leaching of a copper ore by sulphur-oxidizing microorganisms" Elsevier B.V. (2014): 0304-386X
- Kelley, Bruce C. "Biological Contributions to Mineral Cycling in Nature With Reference To Molybdenum." Biotechnology Australia Pty Ltd, NSW. Australia
- Miljak, Dr. D. "Uplift for Copper and Gold via Bulk Ore Sorting." CRC ORE Annual Assembly, Nov. 2016
- Petersen, Jochen. "Heap leaching as a key technology for recovery of values from low-grade ores – A brief overview." Elsevier B.V. (2015): 0304-386X
- Redbook Mining Solutions. BASF
- Sole, Kathryn C. and O. Thinkler."Copper Solvent Extraction: Status, Operating Practices and Challenges in the African Copper Belt." Copper Cobalt Africa, incorporating the 8th Southern African Base Metals Conference. July 2015
- Solutions through the Antagonistic Effect of TRPO on Acorga M5640." Elsevier B.V. (2016): 0304-386X
- Vakylabad, Ali.B. Schaffie, Mahin. Naseri, Ali. Ranjbar, Mohammad. Manafi ,Zahra. "A Procedure for Processing of Pregnant Leach Solution (PLS) Produced from a Chalcopyrite-Ore Bio-Heap: Cu Nano-Powder Fabrication" Elsevier B.V. (2016): 0304-386X
- Von Oertzen, Dr Detlof. "Namibia's Electricity Supply." VO Consulting.Swakopmund, Namibia
- Yang, Ruisi. Wang, Shixiong. Duan, Hengpan. Yuan ,Xiaohong. Huang, Zhangjie. Guo, Hong. Yang, Xiangjun." Efficient Separation of Copper and Nickel from Ammonium Chloride
- Zanbak, Caner. "Heap Leaching Technique in Mining."Euromines, Nov. 2012
- Mintek, Heap Bioleaching of the oxide ore: Report, April 2003
- Mintek, Heap Bioleaching of the sulfide ore: Report, July 2003
- Van Eck and Lurie Pty Ltd, Haib Leach Testwork, April 1993
- MinProc-Davy Joint Venture; Feasibility Study Phase 2 Report, February 1997
- METS, Preliminary Economic Assessment Report, 2018
- METS, Metallurgical Testwork Report, 2020



**J5329 - Deep-South - Haib Copper Project - Process Design Criteria**

Description	Units	Nominal	Design	Ref	Comments	
<b>Site Characteristics</b>						
<b>Haib Copper Project</b>						
Latitude	-	28°41'29" S	28°41'29" S			
Longitude	-	17°51'18" E	17°51'18" E			
Elevation	masl	157	157	1	Noordoewer (closest town)	
Mean Annual Rainfall	mm/a	25-50	25-50	1		
Highest 24 Hour Rainfall Event	mm	47.0	47.0	1		
Winter Dry Bulb Temperature	°C	15.8	15.8	1		
Winter Wet Bulb Temperature	°C	8.6	8.6	1	Temperature at Windhoek	
Summer Dry Bulb Temperature	°C	40.0	40.0	1	Namibia desert Max temp	
Summer Wet Bulb Temperature	°C	35.0	35.0	1		
Summer Daily Range Temperature	°C	20.00	20.00	1		
Maximum Wind Velocity	km/h	15.8	15.8	1	Source: Namibia Weather 2019	
<b>Operating Criteria</b>						
<b>Haib Copper Project</b>						
Resource	Mt	456.9	456.9	1	Client Supplied Data	
Estimated Project Life	yr	54	45	3	METS Assumption	
Days per Year	Days	365	365	7	Other Sources	
Hours per Day	h	24	24	7	Other Sources	
Crusher Availability	%	70%	70%	3	METS Assumption	
Plant Availability	%	90%	90%	3	METS Assumption	
Heap Leach Availability	%	98%	98%	3	METS Assumption	
Plant Utilisation	%	90%	90%	3	METS Assumption	
Feed Moisture	%	3%	3%	3	METS Assumption	
Plant Throughput	t/a	8,500,000	10,200,000	3	METS Assumption	
Plant Throughput	t/h	1,078	1,284	2	METS Calculated Value	
Crusher Throughput	t/h	1,386	1,663	2	METS Calculated Value	
Crusher Operating Hours per Annum	h	6,132	6,132	3	METS Assumption	
Plant Operating Hours per Annum	h	7884	7884	1	Client Supplied Data	
Average Copper Head Grade	%	0.310	0.310	1	Client Supplied Data	
Overall Copper Recovery	%	80	80	2	METS Calculated Value	
Copper Recovered per Annum	t/yr	20,431	25,275	2	METS Calculated Value	
<b>Comminution Characteristics</b>						
Abrasion Index (AI)	-	0.49	0.49	1	Client Supplied Data	
Ore Density	t/m <sup>3</sup>	2.8	2.8	1	Client Supplied Data	
Ore Bulk Density	t/m <sup>3</sup>	1.8	1.8	1	Client Supplied Data	
Crushing Work Index (CWI)	kWh/t	22.3	22.3	1	Client Supplied Data	
Bond Ball Mill Work Index (BWI)	kWh/t	18.0	18.0	1	Client Supplied Data	
Bond Rod Mill Work Index (RWI)	kWh/t	21.6	21.6	1	Client Supplied Data	
Angle of Repose	degrees	36	36	1	Client Supplied Data	
Angle of Reclaim	degrees	55	55	1	Client Supplied Data	
<b>Area 100- Primary and Secondary Crushing</b>						
<b>Crushing Design Basis</b>						
Throughput Operating	t/h	1,386	1,663	2	METS Calculated Value	
<b>Plant Feed Size</b>						
ROM Feed Size	F <sub>100</sub> mm	800	800	3	METS Assumption	
<b>Crushing Product Size</b>						
Screen Undersize	P <sub>20</sub> mm	5.8	5.7	3	METS Assumption	
<b>ROM Bin (100-BN-01)</b>						
Residence Time	h	0.25	0.25	3	METS Assumption	
Capacity	t	347	416	2	METS Calculated Value	
Volume	m <sup>3</sup>	124	148	2	METS Calculated Value	
<b>Gyratory Crusher (100-CR-01)</b>						
Configuration	Open Circuit					
Type	Sandvik CG810i					
Number of Units		1	1	3	METS Assumption	
Feed Rate	t/h	1,386	1,663	2	METS Calculated Value	
Feed Size	F <sub>80</sub> mm	495	495	2	METS Calculated Value	
Product Size	P <sub>20</sub> mm	137	137	2	METS Calculated Value	
Closed Setting	mm	160	160	2	METS Calculated Value	
Stroke	mm	32	32	2	METS Calculated Value	
Crusher Power Rating	kW	500	500	6	Vendor Supplied Data	
<b>Gyratory Crusher Discharge Conveyor (100-CV-01)</b>						
Feed Rate	t/h	1,386	1,663	2	METS Calculated Value	
<b>Cone Crusher Feed Bins (100-BN-02/03)</b>						
Combined Throughput	t/h	2,284	2,792	2	METS Calculated Value	
Units	-	2	2	3	METS Assumption	
Residence Time	h	0.50	0.50	3	METS Assumption	
Capacity per Bin	t	571	698	2	METS Calculated Value	
Volume per Bin	m <sup>3</sup>	317	388	2	METS Calculated Value	
<b>Cone Crushers (100-CR-02/03)</b>						
Type	Sandvik CH870i-03					
No. of Units	#	2	2	3	METS Assumption	
Cavity Type	Standard					
Feed Rate	Per Unit	t/h	1,142	1,396	2	METS Calculated Value
Feed Size	F <sub>80</sub> mm	115	114	2	METS Calculated Value	
Product Size	P <sub>20</sub> mm	40	46	2	METS Calculated Value	
Closed Size Setting	mm	32	38	3	METS Assumption	

**J5329 - Deep-South - Haib Copper Project - Process Design Criteria**

Description	Units	Nominal	Design	Ref	Comments
Power Rating	Per Unit	kW	745	745	6 Vendor Supplied Data
<b>Cone Crusher Screen (100-SC-01)</b>					
Type			Metso TS6.2 Double-Deck Banana		
Feed Rate	t/h	2,284	2,792	2	METS Calculated Value
Screen Area	m <sup>2</sup>	25	25	6	Vendor Supplied Data
No. of Units	#	1	1	3	METS Assumption
Product Size	P <sub>80</sub> mm	24.2	27.1	2	METS Calculated Value
Screen Flow Rates	O/S	t/h	1,129	2	METS Calculated Value
	U/S	t/h	1,386	2	METS Calculated Value
Deck 1 Screen Aperture	mm	50	60	3	METS Assumption
Deck 2 Screen Aperture	mm	35	40	3	METS Assumption
<b>Crushed Ore Stockpile</b>					
Ore Delivery			Conveyor		
Feed Rate	t/h	1,386	1,663	2	METS Calculated Value
Number of Reclaim Chutes	#	2	2	3	METS Assumption
Live Stockpile Residence Time	h	12	12	3	METS Assumption
Live Stockpile Capacity	t	16,634	19,961	2	METS Calculated Value
Live Stockpile Volume	m <sup>3</sup>	9,241	11,083	2	METS Calculated Value
Total Stockpile Volume	m <sup>3</sup>	36,965	44,357	3	METS Assumption
Stockpile Diameter	m	36	39	2	METS Calculated Value
<b>Crushing Plant to the Processing Plant Conveyor (100-CV-07)</b>					
Feed Rate	t/h	1,386	1,663	2	METS Calculated Value
Length	m	TBD	TBD		
<b>Area 200- Tertiary Crushing</b>					
<b>HPGR Feed Stockpile</b>					
Ore Delivery			Conveyor		
Feed Rate	t/h	1,386	1,663	2	METS Calculated Value
Discharge Chutes	#	2	2	3	METS Assumption
Discharge Rate	t/h	1,078	1,294	2	METS Calculated Value
Live Stockpile Residence Time	h	48	48	3	METS Assumption
Live Stockpile Capacity	t	51,750	62,100	2	METS Calculated Value
Live Stockpile Volume	m <sup>3</sup>	28,750	34,500	2	METS Calculated Value
Total Stockpile Volume	m <sup>3</sup>	115,001	138,001	2	METS Calculated Value
Stockpile Diameter	m	53	57	2	METS Calculated Value
<b>HPGR Design Basis</b>					
Availability	%	90.00	90.00	3	METS Assumption
Throughput	t/h	1,078	1,294	2	METS Calculated Value
Fresh Feed Size	mm	24.20	27.10	2	METS Calculated Value
<b>HPGR Feed Bin (200-BN-01/02)</b>					
Fresh Feed	t/h	1,078	1,294	2	METS Calculated Value
Units	-	2	2	3	METS Assumption
Recycle to Fresh Feed Ratio	%	30	30	3	METS Assumption
Recycle Rate	t/h	323	388	2	METS Calculated Value
Feed Rate Total	t/h	1402	1682	2	METS Calculated Value
Residence Time	h	0.17	0.17	3	METS Assumption
Capacity per Bin	t	117	140	2	METS Calculated Value
Volume per Bin	m <sup>3</sup>	65	78	2	METS Calculated Value
<b>HPGR (200-GR-01/02)</b>					
Vendor			Koppers		
Type			630-17.6-ONH 1230 PG1E		
Number	#	2,00	2,00	6	Vendor Supplied Data
Roll Speed	m/s	1.70	1.70	6	Vendor Supplied Data
Roll Length	mm	1000	1000	6	Vendor Supplied Data
Roll Diameter	mm	1700	1700	6	Vendor Supplied Data
Feed Rate (per Unit)	t/h	701	841	2	METS Calculated Value
Feed Size	F <sub>80</sub> mm	22.10	24.20	3	METS Assumption
Product Size	P <sub>80</sub> mm	10.80	11.20	3	METS Assumption
Power Rating	kW	1,800	1,800	3	METS Assumption
<b>HPGR Screen (200-SC-02)</b>					
Type			Metso TS6.2 Double-Deck Banana	3	METS Assumption
Feed Rate	t/h	1402	1682	2	METS Calculated Value
Screen Area	m <sup>2</sup>	50	50	6	Vendor Supplied Data
No. of Units	#	2	2	3	METS Assumption
Product Size - P80	mm	5.8	5.7	3	METS Assumption
Screen Flow Rates	O/S	t/h	388	2	METS Calculated Value
	U/S	t/h	1078	2	METS Calculated Value
Screen Aperture	Top	mm	15	3	METS Assumption
	Middle	mm	10	3	METS Assumption
% Reporting to U/S	%	70	70	3	METS Assumption
<b>Area 300- Agglomeration and Heap Leaching</b>					
<b>Leaching Design Basis</b>					
Feed Rate Solids	dt/h	1046	1255	2	METS Calculated Value
Feed Rate	t/h	1078	1294	2	METS Calculated Value
Feed % Solids	ww %	88.0	88.0	3	METS Assumption
Acid Consumption Rate	kg/t ore	10	10	3	METS Assumption
Barren Pond H <sub>2</sub> SO <sub>4</sub> Concentration	g/L	2.2	2.2	2	METS Calculated Value
Solution pH	-	1.34	1.34	2	METS Calculated Value
Total Acid Solution Rate	m <sup>3</sup> /h	1625	1949	2	METS Calculated Value
Binder Addition	kg/t	0.16	0.16	3	METS Assumption



Client Deep-South Resources  
 Project Haib Copper Project  
 Job # J5329  
 Doc # J5329-P-PDC-000-001  
 Doc Title Process Design Criteria 8.5 Mtpa @ 85% Cu Recovery+CuSO4  
 Rev A

**J5329 - Deep-South - Haib Copper Project - Process Design Criteria**

Description	Units	Nominal	Design	Ref	Comments
Leach Extent Cu	%	85	85	5	Testwork Supplied Data
Leach Extent Al	%	8	8	5	Testwork Supplied Data
Leach Extent Fe	%	64	64	5	Testwork Supplied Data
Temperature	°C	40	40	3	METS Assumption
Total Heap Irrigation Time	days	400	400	3	METS Assumption
Heap Evaporation Losses	%	2	2	3	METS Assumption
Pond Evaporation Losses	mm/day	8	8	3	METS Assumption
<b>Irrigation (300-IR-01-03)</b>					
Number of Leach Stages	#	3.00	3.00	3	METS Assumption
Irrigation Solution		Dilute Sulphuric Acid		3	METS Assumption
Irrigation Rate	L/h/m <sup>2</sup>	10.00	10.00	3	METS Assumption
Irrigation Type		Droppers		3	METS Assumption
Irrigation Solution Density	t/m <sup>3</sup>	1.00	1.00	3	METS Assumption
<b>Agglomerator Feed Bin (300-BN-01)</b>					
Residence Time	min	15	15	3	METS Assumption
Wet Solids Flow	m <sup>3</sup> /h	599	719	2	METS Calculated Value



**J5329 - Deep-South - Haib Copper Project - Process Design Criteria**

Description	Units	Nominal	Design	Ref	Comments
Volume	m <sup>3</sup>	150	180	2	METS Calculated Value
<b>Agglomeration Drum (300-AD-01/02)</b>					
Model/Type	-	Rotary Drum		6	Vendor Supplied Data
No. of Drums	#	2	2	3	METS Assumption
Feed Rate	dt/h	1,046	1,255	2	METS Calculated Value
Feed Rate	t/h Wet	1,078	1,294	2	METS Calculated Value
Water Addition	t/h	110.2	132.3	2	METS Calculated Value
Feed Rate	per Unit	594.2	713.0	2	METS Calculated Value
Total Mass Feed Rate	m <sup>3</sup> /h	709.2	851.0	2	METS Calculated Value
Percent Fill	%	20%	20%	3	METS Assumption
Void Volume	%	50%	50%	3	METS Assumption
Binder Addition	t/h	0.2	0.2	2	METS Calculated Value
Sulphuric Acid Addition	t/h	0.1	0.1	2	METS Calculated Value
Solids Content	%	88	88.0	3	METS Assumption
Residence Time	h	0.02	0.02	3	METS Assumption
Drum Minimum Volume	m <sup>3</sup>	70.9	85.1	2	METS Calculated Value
Drum Designed Volume	m <sup>3</sup>	141.8	170.2	2	METS Calculated Value
Solids Discharge Rate	dt/h	1,046	1,255.1	2	METS Calculated Value
Wet Solids Discharge Rate	t/h	1,189	1,426.3	2	METS Calculated Value
Wet Solids Bulk Density	t/m <sup>3</sup>	2.0	2.0	3	METS Assumption
<b>Primary Heap</b>					
Ore Delivery	-	Radial Stacker		3	METS Assumption
Feed Rate	t/h	1189	1426	2	METS Calculated Value
Irrigation Rate	L/h/m <sup>2</sup>	10.00	10.00	3	METS Assumption
Irrigation Solution	-	ILS	ILS	3	METS Assumption
Temperature	°C	40.00	40.00	3	METS Assumption
Irrigation Solution pH	-	TBD	TBD	3	METS Assumption
Heap Moisture	%	12	12	3	METS Assumption
Live Stockpile	days	120	120	3	METS Assumption
Live Stockpile Capacity	t	3,354,633	3,354,633	2	METS Calculated Value
Leach Extent Cu	%	TBD	TBD		
Leach Extent Mo	%	TBD	TBD		
Leach Extent Al	%	TBD	TBD		
Leach Extent Fe	%	TBD	TBD		
Leachant Discharge Rate	m <sup>3</sup> /h	1,625	1,949	2	METS Calculated Value
Heap Lift Height	m	10.0	10.0	3	METS Assumption
Heap Width	m	40.00	40.00	2	METS Calculated Value
Heap Length	m	120.00	120.00	2	METS Calculated Value
Heap Height	m	36.00	36.00	2	METS Calculated Value
Heap Evaporation Losses	%	2	2	3	METS Assumption
<b>Secondary Heap</b>					
Irrigation Rate	L/h/m <sup>2</sup>	10.00	10.00	3	METS Assumption
Irrigation Solution	-	Barren	Barren	3	METS Assumption
Temperature	°C	40.00	40.00	3	METS Assumption
Irrigation Solution pH	-	TBD	TBD	3	METS Assumption
Heap Moisture	%	12	12	3	METS Assumption
Live Stockpile	days	120	120	3	METS Assumption
Live Stockpile Capacity	t	3,354,633	3,354,633	2	METS Calculated Value
Leach Extent Cu	%	TBD	TBD		
Leach Extent Mo	%	TBD	TBD		
Leach Extent Al	%	TBD	TBD		
Leach Extent Fe	%	TBD	TBD		
Leachant Discharge Rate	m <sup>3</sup> /h	1,625	1,949	2	METS Calculated Value
Heap Lift Height	m	10.00	12.0	3	METS Assumption
Heap Width	m	40.00	40.00	2	METS Calculated Value
Heap Length	m	120.00	120.00	2	METS Calculated Value
Heap Height	m	36.00	36.00	2	METS Calculated Value
Heap Evaporation Losses	%	2	2	3	METS Assumption
<b>Washing Heap</b>					
Irrigation Rate	L/h/m <sup>2</sup>	10.00	10.00	3	METS Assumption
Irrigation Solution	-	Barren	Barren	3	METS Assumption
Temperature	°C	40.00	40.00	5	Testwork Supplied Data
Irrigation Solution pH	-	TBD	TBD	3	METS Assumption
Heap Moisture	%	12	12	3	METS Assumption
Live Stockpile	days	180	180	2	METS Calculated Value
Live Stockpile Capacity	t	4,472,845	4,472,845	3	METS Assumption
Leach Extent Cu	%	TBD	TBD		
Leach Extent Mo	%	TBD	TBD		
Leach Extent Al	%	TBD	TBD		
Leach Extent Fe	%	TBD	TBD		
Leachant Discharge Rate	m <sup>3</sup> /h	2,166	2,599	2	METS Calculated Value
Heap Lift Height	m	10.00	12.00	3	METS Assumption
Heap Width	m	40.00	40.00	2	METS Calculated Value
Heap Length	m	120.00	120.00	2	METS Calculated Value
Heap Height	m	36.00	36.00	2	METS Calculated Value
Heap Evaporation Losses	%	2	2	3	METS Assumption
<b>Active Solution Pond (300-PD-03)</b>					
Volume/pad	m <sup>3</sup>	39,000	46,800	2	METS Calculated Value
Feed Rate (98% operating basis)	m <sup>3</sup> /h	2,166	2,599	2	METS Calculated Value
Solution pH	-	1.31	1.31	2	METS Calculated Value
Temperature	°C	40.00	40.00	3	METS Assumption
Loss From Evaporation	m <sup>3</sup> /h	2.60	3.12	2	METS Calculated Value

**J5329 - Deep-South - Haib Copper Project - Process Design Criteria**

Description	Units	Nominal	Design	Ref	Comments
Discharge Rate (90% operating basis)	m <sup>3</sup> /h	1,642	1,971	2	METS Calculated Value
<b>ILS Pond (300-PD-02)</b>					
Volume/pad	m <sup>3</sup>	39,000	46,800	2	METS Calculated Value
Feed Rate	m <sup>3</sup> /h	2,166	2,599	2	METS Calculated Value
pH		TBD	TBD		
Temperature	°C	40	40	3	METS Assumption
Loss From Evaporation	m <sup>3</sup> /h	2,60	3,12	2	METS Calculated Value
Discharge Rate	m <sup>3</sup> /h	2,166	2,599	2	METS Calculated Value
<b>Barren Pond (300-PD-01)</b>					
Volume/pad	m <sup>3</sup>	39,000	46,800	2	METS Calculated Value
SX Return Feed Rate (90% operating basis)	m <sup>3</sup> /h	1,569	1,883	2	METS Calculated Value
Acid Addition (98% operating basis)	t/h	0.0	0.0	2	METS Calculated Value
Water Addition (98% operating basis)	t/h	184	184	2	METS Calculated Value
pH		1.29	1.29	2	METS Calculated Value
Temperature	°C	40	40	3	METS Assumption
Loss From Evaporation	m <sup>3</sup> /h	2,60	3,12	2	METS Calculated Value
Discharge Rate to Secondary Heap (98% operating basis)	m <sup>3</sup> /h	2,166	2,599	2	METS Calculated Value
<b>Piping and Materials</b>					
Pad Liner Material		1.5 mm HDPE with Thermal Welds		3	METS Assumption
Barren/ILS /PLS /Raffinate Return Piping		HDPE Piping		3	METS Assumption
<b>Area 400- Copper SX and Electrowinning</b>					
<b>Circuit Configuration</b>					
Number of Trains	#	1.00	1.00	2	METS Calculated Value
Configuration		2E x 2S x 1SC	2E x 2S x 1SC	2	METS Calculated Value
Contacting Units		mixer settlers, single distributor and 3 picket fences		3	METS Assumption
Availability	days	7,884	7,884	3	METS Assumption
<b>pH Adjustment Tank (400-TK-01)</b>					
Feed	m <sup>3</sup> /h	1,642	1,971	2	METS Calculated Value
pH Feed	pH	1.31	1.31	2	METS Calculated Value
pH Discharge	pH	2	2	2	METS Calculated Value
Limestone/Calcrete Added	t/h	1	1	2	METS Calculated Value
Residence Time	h	0.08	0.08	3	METS Assumption
Tank Capacity	m <sup>3</sup>	137	164	2	METS Calculated Value
<b>pH Adjustment Thickener (400-TH-01)</b>					
Type of Thickener		High Rate		3	METS Assumption
No. of Thickeners	#	1	1.00	3	METS Assumption
Feed Rate (Solids)	dt/h	1	1.76	2	METS Calculated Value
Feed Rate (Slurry)	m <sup>3</sup> /h	1,643	1,643.01	2	METS Calculated Value
Feed % Solids	w/w %	0.1	0.1	2	METS Calculated Value
Underflow % Solids	w/w %	50	50	3	METS Assumption
Underflow Solid Rate	dt/h	1	1.76	2	METS Calculated Value
Underflow Liquid	t/h	1	1.76	2	METS Calculated Value
Underflow Slurry Rate	t/h	3	3.52	2	METS Calculated Value
Underflow Slurry Rate	m <sup>3</sup> /h	2	2.39	2	METS Calculated Value
Underflow Density	t/m <sup>3</sup>	1.47	1.47	2	METS Calculated Value
Overflow % Solids	w/w %	0.00	0.00	3	METS Assumption
Overflow Solid Rate	dt/h	0.00	0.00	2	METS Calculated Value
Overflow Liquid	t/h	1,641	1,969.22	3	METS Assumption
Overflow Slurry Rate	t/h	1,641	1,969.22	2	METS Calculated Value
Overflow Slurry Rate	m <sup>3</sup> /h	1,641	1,969.22	2	METS Calculated Value
Overflow Density	t/m <sup>3</sup>	1.00	1.00	3	METS Assumption
Flocculant Dosage	g/t	100	100	3	METS Assumption
Floc Rate	kg/h	0.15	0.18	2	METS Calculated Value
Settling Rate	m <sup>2</sup> /h	6.00	6.00	3	METS Assumption
Thickener Cross Sectional Area (Minimum)	m <sup>2</sup>	9	10.55	2	METS Calculated Value
Thickener Diameter (Minimum)	m	3	4.02	2	METS Calculated Value
Upflow Rate	m/h	186.57	223.89	2	METS Calculated Value
Residence Time	h	TBD	TBD		
Thickener Volume	m <sup>3</sup>	TBD	TBD		
<b>pH Adjustment Filter Feed Hopper (400-HP-01)</b>					
Residence Time	min	90	90	3	METS Assumption
Slurry Flow	m <sup>3</sup> /h	2	2	2	METS Calculated Value
Volume	m <sup>3</sup>	3	4	2	METS Calculated Value
<b>pH Adjustment Filter Press (400-FL-01/02)</b>					
Type		Pressure	Pressure	3	METS Assumption
Number of Filter Units	#	1.00	2.00	3	METS Assumption
Feed Rate	(per Unit) dt/h	1.5	1.76	2	METS Calculated Value
% Solids					
Feed	w/w %	50	50	3	METS Assumption
Cake	w/w %	5%	5%	3	METS Assumption
Filtration Rate	kg/m <sup>2</sup> /h	80	80	3	METS Assumption
Filter Area	(per Unit) m <sup>2</sup>	9	11.0	2	METS Calculated Value
Filter Cake Discharge	wet t/h	1.7	2.07	2	METS Calculated Value
Solids Discharge	dt/h	1.5	1.76	2	METS Calculated Value
Cake Moisture	t/h	0.26	0.31	2	METS Calculated Value
<b>SX Feed Polishing Filter (400-FL-03/04/05)</b>					
Type		Polishing	Polishing	3	METS Assumption
Number of Filter Units	#	4.00	4.00	3	METS Assumption
Feed Rate	(per Unit) m <sup>3</sup> /h	410.3	492.3	2	METS Calculated Value

**J5329 - Deep-South - Haib Copper Project - Process Design Criteria**

Description	Units	Nominal	Design	Ref	Comments
Filter Area (per Unit)	m <sup>2</sup>	TBC	TBC		
Filter Cake Discharge (wet)	t/h	TBC	TBC		
Solids Discharge	dt/h	TBC	TBC		
Cake Moisture	t/h	TBC	TBC	3	METS Assumption
Filtrate	m <sup>3</sup> /h	1,641	1,969	2	METS Calculated Value
<b>SX PLS Feed Tank (400-TK-02)</b>					
Residence Time	min	10	10	3	METS Assumption
PLS Flowrate	m <sup>3</sup> /h	1,641	1,969	2	METS Calculated Value
Volume	m <sup>3</sup>	274	329	2	METS Calculated Value
<b>Copper Extraction Mixer Settler (400-SX-01/02)</b>					
Number of Cells	#	2	2	3	METS Assumption
Volume/Cell Minimum (Mixer)	m <sup>3</sup>	82	98	2	METS Calculated Value
Volume/Cell Minimum (Settler)	m <sup>3</sup>	438	525	2	METS Calculated Value
Residence Time (Mixer)	min	1.50	1.50	3	METS Assumption
Residence Time (Settler)	min	8.00	8.00	3	METS Assumption
Feed Rate	m <sup>3</sup> /h	1,641	1,969	2	METS Calculated Value
O/A Ratio		1:1	1:1	3	METS Assumption
Organic in Solvent	%	15	15	3	METS Assumption
Organic Feed Rate	m <sup>3</sup> /h	1,641	1,969	2	METS Calculated Value
LIX Loss Rate	m <sup>3</sup> /h	0.030	0.035	2	METS Calculated Value
Organic Makeup	m <sup>3</sup> /h	0.20	0.24	2	METS Calculated Value
Organic Diluent Loss Rate	m <sup>3</sup> /h	0.17	0.20	2	METS Calculated Value
Temperature	°C	Ambient	Ambient	3	METS Assumption
pH Initial		2.00	2.00	2	METS Calculated Value
Discharge Rate (Loaded Organic)	m <sup>3</sup> /h	1,641	1,969	2	METS Calculated Value
Organic Recovery	%	99.988%	99.988%	3	METS Assumption
Mixer Diameter		TBD	TBD		
Mixer Height		TBD	TBD		
Settler Width		TBD	TBD		
Settler Area Settler Length		TBD	TBD		
Copper Extraction	%	98%	98%	3	METS Assumption
Impurities Extraction	%	0%	0%	3	METS Assumption
<b>Loaded Organic Tank (400-TK-04)</b>					
Organic Feed	m <sup>3</sup> /h	1641	1969	2	METS Calculated Value
Residence Time	h	0.08	0.08	3	METS Assumption
Tank Capacity	m <sup>3</sup>	137	164		
<b>Copper Stripping Mixer Settler (400-SX-03/04)</b>					
Number of Cells	#	2	2	3	METS Assumption
Volume/Cell Minimum (Mixer)	m <sup>3</sup>	43	52	2	METS Calculated Value
Volume/Cell Minimum (Settler)	m <sup>3</sup>	232	278	2	METS Calculated Value
Residence Time (Mixer)	min	1.50	1.50	3	METS Assumption
Residence Time (Settler)	min	8.00	8.00	3	METS Assumption
Organic Feed Rate	m <sup>3</sup> /h	1,641	1,969	2	METS Calculated Value
O/A		16:1	16:1	3	METS Assumption
Stripping Solution Feed Rate	m <sup>3</sup> /h	96.6	115.9	3	METS Assumption
Temperature	°C	Ambient	Ambient	3	METS Assumption
Organic Discharge Rate	m <sup>3</sup> /h	1,641	1,969	2	METS Calculated Value
Aqueous Discharge Rate	m <sup>3</sup> /h	96.6	115.9	2	METS Calculated Value
H <sub>2</sub> SO <sub>4</sub> Concentration	g/L	200.00	200.00	3	METS Assumption
H <sub>2</sub> SO <sub>4</sub> (100%) Required	t/h	19.3	19.3	2	METS Calculated Value
H <sub>2</sub> SO <sub>4</sub> (100%) Recycled	t/h	0.0	0.0	2	METS Calculated Value
H <sub>2</sub> SO <sub>4</sub> (100%) Makeup	t/h	3.3	3.3	2	METS Calculated Value
Temperature	°C	Ambient	Ambient	3	METS Assumption
pH		-0.61	-0.61	2	METS Calculated Value
Split to Electrowinning	%	100	100	3	METS Assumption
Stripping Efficiency	%	100	100	3	METS Assumption
<b>Organic Control Tank (400-TK-03)</b>					
Organic Feed	m <sup>3</sup> /h	1641	1969	2	METS Calculated Value
Residence Time	h	0.08	0.08	3	METS Assumption
Tank Capacity	m <sup>3</sup>	137	164	2	METS Calculated Value
<b>Stripping Liquor Makeup Tank (400-TK-05)</b>					
Feed	m <sup>3</sup> /h	96.6	116	2	METS Calculated Value
Residence Time	h	0.08	0.08	3	METS Assumption
Tank Capacity	m <sup>3</sup>	9	11	2	METS Calculated Value
<b>Copper Electrowinning Cells (400-EC-01--08)</b>					
Number of Cells	#	88	88	2	METS Calculated Value
Electrowin Time	days	TBD	TBD		
Cell Volume	m <sup>3</sup>	TBD	TBD		
Flowrate	m <sup>3</sup> /h	0.4	0.5	2	METS Calculated Value
Current Density	A/m <sup>2</sup>	282.0	282.0	3	METS Assumption
Cell Voltage	V	2.0	2.0	3	METS Assumption
Cathode Material		Stainless Steel Blank Cathodes		3	METS Assumption
Cathode Cleaning		High Pressure Water		3	METS Assumption
Cathode Cleaning Frequency	per week	1.0	1.0	3	METS Assumption
Water Requirement for Cathode Cleaning	m <sup>3</sup> /clean	15.0	18.0	3	METS Assumption
Electrowinning Efficiency	%	100		3	METS Assumption
<b>Copper Sulphate Crystalliser Package (400-PK-01)</b>					
Number of Units	#	1	1.0	3	METS Assumption
Type			Evaporative	3	METS Assumption



Client Deep-South Resources  
 Project Haib Copper Project  
 Job # J5329  
 Doc # J5329-P-PDC-000-001  
 Doc Title Process Design Criteria 8.5 Mtpa @ 85% Cu Recovery+CuSO4  
 Rev A

**J5329 - Deep-South - Haib Copper Project - Process Design Criteria**

Description	Units	Nominal	Design	Ref	Comments
Feed Rate	m <sup>3</sup> /h	61.7	74.0	2	METS Calculated Value
Residence Time	h	1	1.0	3	METS Assumption
Temperature	°C	TBD	TBD		
Crystallisation Rate	t/h	TBD	TBD		
Slurry Discharge Rate	t/h	15.9	19.0	2	METS Calculated Value
Solids %	%	40%	40%	3	METS Assumption
Crystallisation Efficiency	%	100%	100%	3	METS Assumption
<b>Centrifuge</b>					
Type		Screen Scroll Centrifuge		3	METS Assumption
Capacity		TBD	TBD		
Feed Rate	t/h	16	19.0	2	METS Calculated Value
Feed Solids %	%	40%	40%	3	METS Assumption
Discharge Rate	t/h	6.9	8.3	2	METS Calculated Value
Discharge Solids %	%	92%	92%	3	METS Assumption
<b>Flash Dryer</b>					
Type		Flash Dryer			
Feed Rate	t/h	6.9	8.3	2	METS Calculated Value
Residence Time	h	TBD	TBD		
Temperature	°C	TBD	TBD		
Product Discharge Rate	t/h	6.3	7.6	2	METS Calculated Value
Product Solids %	%	99%	98%	3	METS Assumption

**J5329 - Deep-South - Haib Copper Project - Process Design Criteria**

Description	Units	Nominal	Design	Ref	Comments
<b>Area 500- Iron Precipitation</b>					
<b>Iron Precipitation Tank (500-TK-01)</b>					
Number of Tanks	#	1.0		3	METS Assumption
pH		5.8		3	METS Assumption
Temperature	°C	40		3	METS Assumption
Feed Rate	t/h	656		2	METS Calculated Value
Lime Addition Rate	dt/h	0.7	0.9	2	METS Calculated Value
Lime Density	t/m <sup>3</sup>	1.2	1.2	3	METS Assumption
Limestone Addition Rate	dt/h	1.3	1.6	2	METS Calculated Value
Residence Time	h	0.2	0.2	2	METS Calculated Value
Discharge Rate	t/h	659	659.0	2	METS Calculated Value
Capacity	m <sup>3</sup>	110	132	3	METS Assumption
<b>Iron Precipitate Thickener (500-TH-01)</b>					
Type of Thickener	-		High Rate	3	METS Assumption
No. of Thickeners	#	1	1.00	3	METS Assumption
Feed Rate (Solids)	dt/h	63	75.38	2	METS Calculated Value
Feed Rate (Slurry)	m <sup>3</sup> /h	607	728.98	2	METS Calculated Value
Feed % Solids	w/w %	9.7	9.7	2	METS Calculated Value
Underflow % Solids	w/w %	50	50	3	METS Assumption
Underflow Solid Rate	dt/h	63	75.38	2	METS Calculated Value
Underflow Liquid	t/h	63	75.38	2	METS Calculated Value
Underflow Slurry Rate	t/h	126	150.76	2	METS Calculated Value
Underflow Slurry Rate	m <sup>3</sup> /h	85	102.30	2	METS Calculated Value
Underflow Density	t/m <sup>3</sup>	1.47	1.47	2	METS Calculated Value
Overflow % Solids	w/w %	0.00	0.00	3	METS Assumption
Overflow Solid Rate	dt/h	0.00	0.00	2	METS Calculated Value
Overflow Liquid	t/h	533	639.98	3	METS Assumption
Overflow Slurry Rate	t/h	533	639.98	2	METS Calculated Value
Overflow Slurry Rate	m <sup>3</sup> /h	533	639.98	2	METS Calculated Value
Overflow Density	t/m <sup>3</sup>	1.00	1.00	3	METS Assumption
Flocculant Dosage	g/t	100	100	3	METS Assumption
Floc Rate	kg/h	6.28	7.54	2	METS Calculated Value
Settling Rate	m <sup>2</sup> /d	6.00	6.00	3	METS Assumption
Thickener Cross Sectional Area (Minimum)	m <sup>2</sup>	377	452.27	2	METS Calculated Value
Thickener Diameter (Minimum)	m	22	26.29	2	METS Calculated Value
Upflow Rate	m/h	1.42	1.70	2	METS Calculated Value
Residence Time	h	TBD	TBD		
Thickener Volume	m <sup>3</sup>	TBD	TBD		
<b>Iron Tailings Filter Feed Tank (500-TK-02)</b>					
Residence Time	min	30	30	3	METS Assumption
Slurry Flow	m <sup>3</sup> /h	85	102	2	METS Calculated Value
Volume	m <sup>3</sup>	43	52	2	METS Calculated Value
<b>Iron Tailings Filter Press (500-FL-01/02)</b>					
Type	-		Pressure	3	METS Assumption
Number of Filter Units	#	2.00	2.00	3	METS Assumption
Feed Rate (per Unit)	dt/h	31.4	37.69	2	METS Calculated Value
% Solids					
Feed	w/w %	50	50	3	METS Assumption
Cake	w/w %	10	10	3	METS Assumption
Filtration Rate	kg/m <sup>2</sup> /h	80	80	3	METS Assumption
Filter Area (per Unit)	m <sup>2</sup>	196	235.6	2	METS Calculated Value
Filter Cake Discharge	wet t/h	73.9	88.68	2	METS Calculated Value
Solids Discharge	dt/h	62.8	75.38	2	METS Calculated Value
Cake Moisture	t/h	11.09	13.30	2	METS Calculated Value
<b>Raffinate Recycle Tank (500-TK-03)</b>					
Residence Time	minutes	5	5	3	METS Assumption
Flow from Filtrate	m <sup>3</sup> /h	74	89	2	METS Calculated Value
Flow From Thickener	m <sup>3</sup> /h	533	640	2	METS Calculated Value
Flow rate (Total)	m <sup>3</sup> /h	607	729	2	METS Calculated Value
Volume	m <sup>3</sup>	51	61	2	METS Calculated Value
<b>Area 600 - Process and Raw Water</b>					
<b>Raw Water Dam (600-DM-01/02)</b>					
Raw Water Requirement	m <sup>3</sup> /h	140	168	2	METS Calculated Value
Raw Water Requirement	m <sup>3</sup> /d	3,353	4,023	2	METS Calculated Value
Residence Time	d	5	5	3	METS Assumption
Storage Capacity	m <sup>3</sup>	16,800	20,160	2	METS Calculated Value
<b>Raw Water Tank (600-TK-02)</b>					
Raw Water Requirement	m <sup>3</sup> /h	140	168	2	METS Calculated Value
Raw Water Requirement	m <sup>3</sup> /d	3353	4,023	2	METS Calculated Value
Residence Time	d	1	1	3	METS Assumption
Storage Capacity	m <sup>3</sup>	3400	4,080	2	METS Calculated Value
<b>Process Water Tank (600-TK-01/03)</b>					
Process Water Drawdown	m <sup>3</sup> /h	60	72	3	METS Assumption
Raw Water Requirement	m <sup>3</sup> /h	15	18	3	METS Assumption
Residence Time	d	1	1	3	METS Assumption
Storage Capacity	m <sup>3</sup>	1500	1,800	2	METS Calculated Value
<b>Raw Water</b>					

**J5329 - Deep-South - Haib Copper Project - Process Design Criteria**

Description	Units	Nominal	Design	Ref	Comments
<b>Supply Source</b>		Orange River			
<b>Analysis</b>					
pH		TBD			
E Coil		TBD			
Copper	ppm	TBD			
Iron	ppm	TBD			
Cobalt	ppm	TBD			
Nickel	ppm	TBD			
TSS	ppm	TBD			
TDS	ppm	TBD			
Total Sulphate	ppm	TBD			
<b>Potable Water Quality</b>					
pH	-	6.5-8	8.00		
Conductivity	µS/cm	TBD	5.80		
Total Dissolved Solids	mg/l	TBD	500		
Total Hardness as CaCO <sub>3</sub>	mg/l	TBD	200		
Na <sup>+</sup>	mg/l	TBD	180		
Cl <sup>-</sup>	mg/l	TBD	250		
Cl <sub>2</sub>	mg/l	TBD	5.00		
SO <sub>4</sub>	mg/l	TBD	250		
<b>Area 700- Reagents</b>					
<b>LIX-984N</b>					
Supply Method	-	Bulk		3	METS Assumption
Supply Form	-	Liquid		3	METS Assumption
Supply Bulk Density	t/m <sup>3</sup>	0.88	-	4	Market Specification
Storage Tank Residence Time	h	48	48.00	3	METS Assumption
Storage Tank Capacity	m <sup>3</sup>	2.00	2.40	2	METS Calculated Value
Mixing Tank Capacity	m <sup>3</sup>	1.00	1.20	2	METS Calculated Value
Mixing Tank Residence Time	h	5	5.00	3	METS Assumption
O in Solvent	%w/w	15	15.00	3	METS Assumption
Addition	m <sup>3</sup> /h	0.03	0.03	2	METS Calculated Value
Raw Diluent for Mixing	m <sup>3</sup> /h	0.17	0.17	2	METS Calculated Value
<b>Kerosene</b>					
Supply Method	-	Bulk		3	METS Assumption
Supply Form	-	Liquid		3	METS Assumption
Supply Bulk Density	t/m <sup>3</sup>	0.81		3	METS Assumption
Kerosene Process Feed	m <sup>3</sup> /h	0.17	0.20	2	METS Calculated Value
Storage Residence Time	h	24	24	3	METS Assumption
Storage Tank Capacity	m <sup>3</sup>	5.00	6.00	2	METS Calculated Value
<b>Quicklime</b>					
Supply Method	-	Bulk		3	METS Assumption
Supply Form	-	Solid		3	METS Assumption
Supply Density	t/m <sup>3</sup>	3.35		7	Other Sources
Supply Bulk Density	t/m <sup>3</sup>	0.88		7	Other Sources
Storage Residence Time	h	24		3	METS Assumption
Process Lime Requirement	t/h	0.75	0.80	2	METS Calculated Value
Raw Water for Mixing	m <sup>3</sup> /h	2.25	2.70	2	METS Calculated Value
Storage Silo Volume	m <sup>3</sup>	21.0	25.20	2	METS Calculated Value
Distribution Tank Residence Time	h	1	1	3	METS Assumption
Distribution Tank Volume	m <sup>3</sup>	3.00	3.60	2	METS Calculated Value
% Solids	%w/w	25%	25%	3	METS Assumption
<b>Limestone/Calcrete</b>					
Supply Method	-	Bulk		3	METS Assumption
Supply Form	-	Solid		3	METS Assumption
Supply Density	t/m <sup>3</sup>	2.60		7	Other Sources
Storage Residence Time	h	24		3	METS Assumption
Process Lime Requirement	t/h	2.41	2.90	2	METS Calculated Value
Raw Water for Mixing	m <sup>3</sup> /h	7.24	8.69	2	METS Calculated Value
Storage Silo Volume	m <sup>3</sup>	23.0	27.60	2	METS Calculated Value
Distribution Tank Residence Time	h	1	1	3	METS Assumption
Distribution Tank Volume	m <sup>3</sup>	9.00	10.80	2	METS Calculated Value
% Solids	%w/w	25%	25%	3	METS Assumption
<b>Sulphuric Acid</b>					
Supply Method	-	Bulk Tanker		3	METS Assumption
Supply Form	-	Liquid		3	METS Assumption
H <sub>2</sub> SO <sub>4</sub> Density	t/m <sup>3</sup>	1.84		3	METS Assumption
H <sub>2</sub> SO <sub>4</sub> Process Requirement	t/h	3.46		2	METS Calculated Value
H <sub>2</sub> SO <sub>4</sub> Process Requirement	m <sup>3</sup> /h	1.88	2.26	2	METS Calculated Value
H <sub>2</sub> SO <sub>4</sub> Storage Residence Time	h	24	24	3	METS Assumption
H <sub>2</sub> SO <sub>4</sub> Storage Tank Capacity	m <sup>3</sup>	46	55.20	2	METS Calculated Value
<b>Binder</b>					
Supply Method	-	Bulk Bag		3	METS Assumption
Supply Form	-	Solid		3	METS Assumption
Supply Bulk Density	t/m <sup>3</sup>	2.00		3	METS Assumption
Storage Residence Time	h	12		3	METS Assumption
Binder Consumption	kg/t	0.50		3	METS Assumption
Process Requirement	t/h	0.2	0.19	2	METS Calculated Value
Binder Feed Hopper Capacity	m <sup>3</sup>	1.0	1.20	2	METS Calculated Value
<b>Flocculant</b>					



Client Deep-South Resources  
 Project Haib Copper Project  
 Job # J5329  
 Doc # J5329-P-PDC-000-001  
 Doc Title Process Design Criteria 8.5 Mtpa @ 85% Cu Recovery+CuSO4  
 Rev A

**J5329 - Deep-South - Haib Copper Project - Process Design Criteria**

Description	Units	Nominal	Design	Ref	Comments
Type	-	Magnifloc 155	-	3	METS Assumption
Supply Method	-	25 kg Bags	-	3	METS Assumption
Supply Form	-	Solid	-	3	METS Assumption
Flocculant Mixing Tank Residence Time	h	2	-	3	METS Assumption
Flocculant Storage Tank Residence Time	h	24	-	3	METS Assumption
Flocculant Mixing Tank Capacity	L	10	-	2	METS Calculated Value
Flocculant Storage Tank Capacity	m <sup>3</sup>	1	-	2	METS Calculated Value
Bulk Density	t/m <sup>3</sup>	0.75	-	7	Other Sources
Total Addition Rate	kg/h	6.43	7.71	3	METS Assumption
Addition Concentration	%w/v	25	25	3	METS Assumption
Inline Mixer Dilution	%w/v	2.5	2.5	3	METS Assumption
Viscosity (After dilution)	cP	300	300	3	METS Assumption
Addition Concentration (Belt Filter)	%w/v	25	25	3	METS Assumption
Raw Water for Mixing	m <sup>3</sup> /h	0.0003	0.0004	2	METS Calculated Value
<b>Area 800- Services</b>					
<b>Air Compressor</b>					
HP Air Compressor Type	-	Screw	-	3	METS Assumption
HP Air Pressure	kPa	750	-	3	METS Assumption
HP Air Compressor Capacity	Nm <sup>3</sup> /h	250	300	3	METS Assumption
<b>Plant Air Filter</b>					
Type	-	-	-	-	-
<b>Plant Air Receiver</b>					
Type	-	Standard Receiver Vessel	-	3	METS Assumption
HP Air Receiver Volume	L	-	-	3	METS Assumption
<b>Instrument Air</b>					
Instrument Air Pressure	kPa	750	-	3	METS Assumption
HP Air Compressor Capacity	m <sup>3</sup> /h	-	-	-	-

**J5329 - Deep-South - Haib Copper Project - Process Design Criteria**

Description		Units	Nominal	Design	Ref	Comments
<b>Site Characteristics</b>						
<b>Haib Copper Project</b>						
Latitude		-	28°41'29 S	28°41'29 S		
Longitude		-	17°51'18 E	17°51'18 E		
Elevation		masl	157	157	1	Noordoewer (closest town)
Mean Annual Rainfall		mm/a	25-50	25-50	1	
Highest 24 Hour Rainfall Event		mm	47.0	47.0	1	
Winter Dry Bulb Temperature		°C	15.8	15.8	1	
Winter Wet Bulb Temperature		°C	8.6	8.6	1	Tempeture at Windhoek
Summer Dry Bulb Temperature		°C	40.0	40.0	1	Namibia desert Max temp
Summer Wet Bulb Temperature		°C	35.0	35.0	1	
Summer Daily Range Temperature		°C	20.00	20.00	1	
Maximum Wind Velocity		km/h	15.8	15.8	1	Source: Namibia Weather 2019
<b>Operating Criteria</b>						
<b>Haib Copper Project</b>						
Resource		Mt	456.9	456.9	1	Client Supplied Data
Estimated Project Life		yr	54	45	3	METS Assumption
Days per Year		Days	365	365	7	Other Sources
Hours per Day		h	24	24	7	Other Sources
Crusher Availability		%	70%	70%	3	METS Assumption
Plant Availability		%	90%	90%	3	METS Assumption
Heap Leach Availability		%	98%	98%	3	METS Assumption
Plant Utilisation		%	90%	90%	3	METS Assumption
Feed Moisture		%	3%	3%	3	METS Assumption
Plant Throughput		t/a	8,500,000	10,200,000	3	METS Assumption
Plant Throughput		t/h	1,078	1,294	2	METS Calculated Value
Crusher Throughput		t/h	1,386	1,663	2	METS Calculated Value
Crusher Operating Hours per Annum		h	6,132	6,132	3	METS Assumption
Plant Operating Hours per Annum		h	7884	7884	1	Client Supplied Data
Average Copper Head Grade		%	0.310	0.310	1	Client Supplied Data
Overall Copper Recovery		%	85	85	2	METS Calculated Value
Copper Recovered per Annum		t/yr	21,708	26,855	2	METS Calculated Value
<b>Comminution Characteristics</b>						
Abrasion Index (Ai)		-	0.49	0.49	1	Client Supplied Data
Ore Density		t/m <sup>3</sup>	2.8	2.8	1	Client Supplied Data
Ore Bulk Density		t/m <sup>3</sup>	1.8	1.8	1	Client Supplied Data
Crushing Work Index (CWi)		kWh/t	22.3	22.3	1	Client Supplied Data
Bond Ball Mill Work Index (BWi)		kWh/t	18.0	18.0	1	Client Supplied Data
Bond Rod Mill Work Index (RWi)		kWh/t	21.6	21.6	1	Client Supplied Data
Angle of Repose		degrees	36	36	1	Client Supplied Data
Angle of Reclaim		degrees	55	55	1	Client Supplied Data
<b>Area 100- Primary and Secondary Crushing</b>						
<b>Crushing Design Basis</b>						
Throughput Operating		t/h	1,386	1,663	2	METS Calculated Value
<b>Plant Feed Size</b>						
ROM Feed Size		F <sub>100</sub> mm	800	800	3	METS Assumption
<b>Crushing Product Size</b>						
Screen Undersize		P <sub>80</sub> mm	5.8	5.7	3	METS Assumption
<b>ROM Bin (100-BN-01)</b>						
Residence Time		h	0.25	0.25	3	METS Assumption
Capacity		t	347	416	2	METS Calculated Value
Volume		m <sup>3</sup>	124	149	2	METS Calculated Value
<b>Gyratory Crusher (100-CR-01)</b>						
Configuration			Open Circuit			
Type			Sandvik CG810i			
Number of Units			1	1	3	METS Assumption
Feed Rate		t/h	1,386	1,663	2	METS Calculated Value
Feed Size		F <sub>80</sub> mm	495	495	2	METS Calculated Value
Product Size		P <sub>80</sub> mm	137	137	2	METS Calculated Value
Closed Setting		mm	160	160	2	METS Calculated Value
Stroke		mm	32	32	2	METS Calculated Value
Crusher Power Rating		kW	500	500	6	Vendor Supplied Data
<b>Gyratory Crusher Discharge Conveyor (100-CV-01)</b>						
Feed Rate		t/h	1,386	1,663	2	METS Calculated Value
<b>Cone Crusher Feed Bins (100-BN-02/03)</b>						
Combined Throughput		t/h	2,284	2,792	2	METS Calculated Value
Units		-	2	2	3	METS Assumption
Residence Time		h	0.50	0.50	3	METS Assumption
Capacity per Bin		t	571	698	2	METS Calculated Value
Volume per Bin		m <sup>3</sup>	317	388	2	METS Calculated Value
<b>Cone Crushers (100-CR-02/03)</b>						
Type			Sandvik CH870i:03			
No. of Units		#	2	2	3	METS Assumption
Cavity Type		-	Standard Fine	Standard Coarse		
Feed Rate	Per Unit	t/h	1,142	1,396	2	METS Calculated Value
Feed Size		F <sub>80</sub> mm	115	114	2	METS Calculated Value
Product Size		P <sub>80</sub> mm	40	46	2	METS Calculated Value
Closed Size Setting		mm	32	38	3	METS Assumption
Power Rating	Per Unit	kW	746	746	6	Vendor Supplied Data
<b>Cone Crusher Screen (100-SC-01)</b>						
Type			Metso TS6.2 Double-Deck Banana			
Feed Rate		t/h	2,284	2,792	2	METS Calculated Value
Screen Area		m <sup>2</sup>	25	25	6	Vendor Supplied Data
No. of Units		#	1	1	3	METS Assumption
Product Size		P <sub>80</sub> mm	24.2	27.1	2	METS Calculated Value
Screen Flow Rates	O/S	t/h	898	1,129	2	METS Calculated Value
	U/S	t/h	1,386	1,663	2	METS Calculated Value
Deck 1 Screen Aperture		mm	50	60	3	METS Assumption



**J5329 - Deep-South - Haib Copper Project - Process Design Criteria**

Description	Units	Nominal	Design	Ref	Comments	
Deck 2 Screen Aperture	mm	35	40	3	METS Assumption	
<b>Crushed Ore Stockpile</b>						
Ore Delivery Conveyor						
Feed Rate	t/h	1,386	1,663	2	METS Calculated Value	
Number of Reclaim Chutes	#	2	2	3	METS Assumption	
Live Stockpile Residence Time	h	12	12	3	METS Assumption	
Live Stockpile Capacity	t	16,634	19,961	2	METS Calculated Value	
Live Stockpile Volume	m <sup>3</sup>	9,241	11,089	2	METS Calculated Value	
Total Stockpile Volume	m <sup>3</sup>	36,965	44,357	3	METS Assumption	
Stockpile Diameter	m	36	39	2	METS Calculated Value	
<b>Crushing Plant to the Processing Plant Conveyor (100-CV-07)</b>						
Feed Rate	t/h	1,386	1,663	2	METS Calculated Value	
Length	m	TBD	TBD			
<b>Area 200- Tertiary Crushing</b>						
<b>HPGR Feed Stockpile</b>						
Ore Delivery Conveyor						
Feed Rate	t/h	1,386	1,663	2	METS Calculated Value	
Discharge Chutes	#	2	2	3	METS Assumption	
Discharge Rate	t/h	1,078	1,294	2	METS Calculated Value	
Live Stockpile Residence Time	h	48	48	3	METS Assumption	
Live Stockpile Capacity	t	51,750	62,100	2	METS Calculated Value	
Live Stockpile Volume	m <sup>3</sup>	28,750	34,500	2	METS Calculated Value	
Total Stockpile Volume	m <sup>3</sup>	115,001	138,001	2	METS Calculated Value	
Stockpile Diameter	m	53	57	2	METS Calculated Value	
<b>HPGR Design Basis</b>						
Availability	%	90.00	90.00	3	METS Assumption	
Throughput	t/h	1,078	1,294	2	METS Calculated Value	
Fresh Feed Size	mm	24.20	27.10	2	METS Calculated Value	
<b>HPGR Feed Bin (200-BN-01/02)</b>						
Fresh Feed	t/h	1,078	1,294	2	METS Calculated Value	
Units	-	2	2	3	METS Assumption	
Recycle to Fresh Feed Ratio	%	30	30	3	METS Assumption	
Recycle Rate	t/h	323	388	2	METS Calculated Value	
Feed Rate Total	t/h	1402	1682	2	METS Calculated Value	
Residence Time	h	0.17	0.17	3	METS Assumption	
Capacity per Bin	t	117	140	2	METS Calculated Value	
Volume per Bin	m <sup>3</sup>	65	78	2	METS Calculated Value	
<b>HPGR (200-GR-01/02)</b>						
Vendor		Koppert				
Type		630-17,6-ONH 1230 PG1E				
Number	#	2.00	2.00			
Roll Speed	m/s	1.70	1.70	6	Vendor Supplied Data	
Roll Length	mm	1000	1000	6	Vendor Supplied Data	
Roll Diameter	mm	1700	1700	6	Vendor Supplied Data	
Feed Rate (per Unit)	t/h	701	841	2	METS Calculated Value	
Feed Size	F <sub>80</sub> mm	22.10	24.20	3	METS Assumption	
Product Size	P <sub>80</sub> mm	10.80	11.20	3	METS Assumption	
Power Rating	kW	1,800	1,800	3	METS Assumption	
<b>HPGR Screen (200-SC-02)</b>						
Type	-	Metso TS6.2 Double-Deck Banana		3	METS Assumption	
Feed Rate	t/h	1402	1682	2	METS Calculated Value	
Screen Area	m <sup>2</sup>	50	50	6	Vendor Supplied Data	
No of Units	#	2	2	3	METS Assumption	
Product Size , P80	mm	5.8	5.7	3	METS Assumption	
Screen Flow Rates	O/S	t/h	323	388	2	METS Calculated Value
	U/S	t/h	1078	1294	2	METS Calculated Value
Screen Aperture	Top	mm	15	14	3	METS Assumption
	Middle	mm	10	10	3	METS Assumption
% Reporting to U/S	%	70	70	3	METS Assumption	
<b>Area 300- Agglomeration and Heap Leaching</b>						
<b>Leaching Design Basis</b>						
Feed Rate Solids	dt/h	1046	1255	2	METS Calculated Value	
Feed Rate	t/h	1078	1294	2	METS Calculated Value	
Feed % Solids	w/w %	88.0	88.0	3	METS Assumption	
Acid Consumption Rate	kg/t ore	10	10	3	METS Assumption	
Barren Pond H <sub>2</sub> SO <sub>4</sub> Concentration	g/L	2.3	2.3	2	METS Calculated Value	
Solution pH	-	1.33	1.33	2	METS Calculated Value	
Total Acid Solution Rate	m <sup>3</sup> /h	1625	1949	2	METS Calculated Value	
Binder Addition	kg/t	0.16	0.16	3	METS Assumption	
Leach Extent Cu	%	85	85	5	Testwork Supplied Data	
Leach Extent Al	%	8	8	5	Testwork Supplied Data	
Leach Extent Fe	%	68	68	5	Testwork Supplied Data	
Temperature	°C	40	40	3	METS Assumption	
Total Heap Irrigation Time	days	400	400	3	METS Assumption	
Heap Evaporation Losses	%	2	2	3	METS Assumption	
Pond Evaporation Losses	mm/day	8	8	3	METS Assumption	
<b>Irrigation (300-IR-01-03)</b>						
Number of Leach Stages	#	3.00	3.00	3	METS Assumption	
Irrigation Solution		Dilute Sulphuric Acid		3	METS Assumption	
Irrigation Rate	L/h/m <sup>2</sup>	10.00	10.00	3	METS Assumption	
Irrigation Type		Drippers		3	METS Assumption	
Irrigation Solution Density	t/m <sup>3</sup>	1.00	1.00	3	METS Assumption	
<b>Agglomerator Feed Bin (300-BN-01)</b>						
Residence Time	min	15	15	3	METS Assumption	
Wet Solids Flow	m <sup>3</sup> /h	599	719	2	METS Calculated Value	

**J5329 - Deep-South - Haib Copper Project - Process Design Criteria**

Description	Units	Nominal	Design	Ref	Comments
Volume	m <sup>3</sup>	150	180	2	METS Calculated Value
<b>Agglomeration Drum (300-AD-01/02)</b>					
Model/Type	-		Rotary Drum	6	Vendor Supplied Data
No. of Drums	#	2	2	3	METS Assumption
Feed Rate	dt/h	1,046	1,255	2	METS Calculated Value
Feed Rate	Wet t/h	1,078	1,294	2	METS Calculated Value
Water Addition	t/h	110.2	132.3	2	METS Calculated Value
Feed Rate	per Unit t/h	594.2	713.0	2	METS Calculated Value
Total Mass Feed Rate	m <sup>3</sup> /h	709.2	851.0	2	METS Calculated Value
Percent Fill	%	20%	20%	3	METS Assumption
Void Volume	%	50%	50%	3	METS Assumption
Binder Addition	t/h	0.2	0.2	2	METS Calculated Value
Sulphuric Acid Addition	t/h	0.1	0.1	2	METS Calculated Value
Solids Content	%	88	88.0	3	METS Assumption
Residence Time	h	0.02	0.02	3	METS Assumption
Drum Minimum Volume	m <sup>3</sup>	70.9	85.1	2	METS Calculated Value
Drum Designed Volume	m <sup>3</sup>	141.8	170.2	2	METS Calculated Value
Solids Discharge Rate	dt/h	1,046	1,255.1	2	METS Calculated Value
Wet Solids Discharge Rate	t/h	1,189	1,426.3	2	METS Calculated Value
Wet Solids Bulk Density	t/m <sup>3</sup>	2.0	2.0	3	METS Assumption
<b>Primary Heap</b>					
Ore Delivery			Radial Stacker	3	METS Assumption
Feed Rate	t/h	1189	1426	2	METS Calculated Value
Irrigation Rate	L/h/m <sup>2</sup>	10.00	10.00	3	METS Assumption
Irrigation Solution	-	ILS	ILS	3	METS Assumption
Temperature	°C	40.00	40.00	3	METS Assumption
Irrigation Solution pH		TBD	TBD	3	METS Assumption
Heap Moisture	%	12	12	3	METS Assumption
Live Stockpile	days	120	120	3	METS Assumption
Live Stockpile Capacity	t	3,354,633	3,354,633	2	METS Calculated Value
Leach Extent Cu	%	TBD	TBD		
Leach Extent Mo	%	TBD	TBD		
Leach Extent Al	%	TBD	TBD		
Leach Extent Fe	%	TBD	TBD		
Leachant Discharge Rate	m <sup>3</sup> /h	1,625	1,949	2	METS Calculated Value
Heap Lift Height	m	10.0	10.0	3	METS Assumption
Heap Width	m	120.00	120.00	2	METS Calculated Value
Heap Length	m	500.00	500.00	2	METS Calculated Value
Heap Height	m	40.00	40.00	2	METS Calculated Value
Heap Evaporation Losses	%	2	2	3	METS Assumption
<b>Secondary Heap</b>					
Irrigation Rate	L/h/m <sup>2</sup>	10.00	10.00	3	METS Assumption
Irrigation Solution	-	Barren	Barren	3	METS Assumption
Temperature	°C	40.00	40.00	3	METS Assumption
Irrigation Solution pH		TBD	TBD	3	METS Assumption
Heap Moisture	%	12	12	3	METS Assumption
Live Stockpile	days	120	120	3	METS Assumption
Live Stockpile Capacity	t	3,354,633	3,354,633	2	METS Calculated Value
Leach Extent Cu	%	TBD	TBD		
Leach Extent Mo	%	TBD	TBD		
Leach Extent Al	%	TBD	TBD		
Leach Extent Fe	%	TBD	TBD		
Leachant Discharge Rate	m <sup>3</sup> /h	1,625	1,949	2	METS Calculated Value
Heap Lift Height	m	10.00	12.0	3	METS Assumption
Heap Width	m	120.00	120.00	2	METS Calculated Value
Heap Length	m	500.00	500.00	2	METS Calculated Value
Heap Height	m	40.00	40.00	2	METS Calculated Value
Heap Evaporation Losses	%	2	2	3	METS Assumption
<b>Washing Heap</b>					
Irrigation Rate	L/h/m <sup>2</sup>	10.00	10.00	3	METS Assumption
Irrigation Solution	-	Barren	Barren	3	METS Assumption
Temperature	°C	40.00	40.00	5	Testwork Supplied Data
Irrigation Solution pH		TBD	TBD	3	METS Assumption
Heap Moisture	%	12	12	3	METS Assumption
Live Stockpile	days	160	160	2	METS Calculated Value
Live Stockpile Capacity	t	4,472,845	4,472,845	3	METS Assumption
Leach Extent Cu	%	TBD	TBD		
Leach Extent Mo	%	TBD	TBD		
Leach Extent Al	%	TBD	TBD		
Leach Extent Fe	%	TBD	TBD		
Leachant Discharge Rate	m <sup>3</sup> /h	2,166	2,599	2	METS Calculated Value
Heap Lift Height	m	10.00	12.00	3	METS Assumption
Heap Width	m	120.00	120.00	2	METS Calculated Value
Heap Length	m	500.00	500.00	2	METS Calculated Value
Heap Height	m	40.00	40.00	2	METS Calculated Value
Heap Evaporation Losses	%	2	2	3	METS Assumption
<b>Active Solution Pond (300-PD-03)</b>					
Volume/pad	m <sup>3</sup>	39,000	46,800	2	METS Calculated Value
Feed Rate (98% operating basis)	m <sup>3</sup> /h	2,166	2,599	2	METS Calculated Value
Solution pH		1.21	1.21	2	METS Calculated Value
Temperature	°C	40.00	40.00	3	METS Assumption
Loss From Evaporation	m <sup>3</sup> /h	2.60	3.12	2	METS Calculated Value
Discharge Rate (90% operating basis)	m <sup>3</sup> /h	1,642	1,971	2	METS Calculated Value
<b>ILS Pond (300-PD-02)</b>					
Volume/pad	m <sup>3</sup>	39,000	46,800	2	METS Calculated Value
Feed Rate	m <sup>3</sup> /h	2,166	2,599	2	METS Calculated Value
pH		TBD	TBD		
Temperature	°C	40	40	3	METS Assumption
Loss From Evaporation	m <sup>3</sup> /h	2.60	3.12	2	METS Calculated Value
Discharge Rate	m <sup>3</sup> /h	2,166	2,599	2	METS Calculated Value

**J5329 - Deep-South - Haib Copper Project - Process Design Criteria**

Description	Units	Nominal	Design	Ref	Comments
<b>Barren Pond (300-PD-01)</b>					
Volume/pad	m <sup>3</sup>	39,000	46,800	2	METS Calculated Value
SX Return Feed Rate (90% operating basis)	m <sup>3</sup> /h	1,566	1,879	2	METS Calculated Value
Acid Addition (98% operating basis)	t/h	0.0	0.0	2	METS Calculated Value
Water Addition (98% operating basis)	t/h	186	186	2	METS Calculated Value
pH		1.27	1.27	2	METS Calculated Value
Temperature	°C	40	40	3	METS Assumption
Loss From Evaporation	m <sup>3</sup> /h	2.60	3.12	2	METS Calculated Value
Discharge Rate to Secondary Heap (98% operating basis)	m <sup>3</sup> /h	2,166	2,599	2	METS Calculated Value
<b>Piping and Materials</b>					
Pad Liner Material		1.5 mm HDPE with Thermal Welds		3	METS Assumption
Barren/ILS /PLS /Raffinate Return Piping		HDPE Piping		3	METS Assumption
<b>Area 400- Copper SX and Electrowinning</b>					
<b>Circuit Configuration</b>					
Number of Trains	#	1.00	1.00	2	METS Calculated Value
Configuration		2E x 2S x 1SC	2E x 2S x 1SC	2	METS Calculated Value
Contacting Units	ppm	ers, single distributor and 3 p		3	METS Assumption
Availability	days	7,884	7,884	3	METS Assumption
<b>pH Adjustment Tank (400-TK-01)</b>					
Feed	m <sup>3</sup> /h	1,642	1,971	2	METS Calculated Value
pH Feed	pH	1.21	1.21	2	METS Calculated Value
pH Discharge	pH	2	2	2	METS Calculated Value
Limestone/Calcrete Added	t/h	2	2	2	METS Calculated Value
Residence Time	h	0.08	0.08	3	METS Assumption
Tank Capacity	m <sup>3</sup>	137	164	2	METS Calculated Value
<b>pH Adjustment Thickener (400-TH-01)</b>					
Type of Thickener			High Rate	3	METS Assumption
No. of Thickeners	#	1	1.00	3	METS Assumption
Feed Rate (Solids)	dt/h	3	3.36	2	METS Calculated Value
Feed Rate (Slurry)	m <sup>3</sup> /h	1,643	1,643.48	2	METS Calculated Value
Feed % Solids	w/w %	0.2	0.2	2	METS Calculated Value
Underflow % Solids	w/w %	50	50	3	METS Assumption
Underflow Solid Rate	dt/h	3	3.36	2	METS Calculated Value
Underflow Liquid	t/h	3	3.36	2	METS Calculated Value
Underflow Slurry Rate	t/h	6	6.72	2	METS Calculated Value
Underflow Slurry Rate	m <sup>3</sup> /h	4	4.56	2	METS Calculated Value
Underflow Density	t/m <sup>3</sup>	1.47	1.47	2	METS Calculated Value
Overflow % Solids	w/w %	0.00	0.00	3	METS Assumption
Overflow Solid Rate	dt/h	0.00	0.00	2	METS Calculated Value
Overflow Liquid	t/h	1,640	1,967.62	3	METS Assumption
Overflow Slurry Rate	t/h	1,640	1,967.62	2	METS Calculated Value
Overflow Slurry Rate	m <sup>3</sup> /h	1,640	1,967.62	2	METS Calculated Value
Overflow Density	t/m <sup>3</sup>	1.00	1.00	3	METS Assumption
Flocculant Dosage	g/t	100	100	3	METS Assumption
Floc Rate	kg/h	0.28	0.34	2	METS Calculated Value
Settling Rate	m <sup>2</sup> /t/d	6.00	6.00	3	METS Assumption
Thickener Cross Sectional Area (Minimum)	m <sup>2</sup>	17	20.17	2	METS Calculated Value
Thickener Diameter (Minimum)	m	5	5.55	2	METS Calculated Value
Upflow Rate	m/h	97.57	117.08	2	METS Calculated Value
Residence Time	h	TBD	TBD		
Thickener Volume	m <sup>3</sup>	TBD	TBD		
<b>pH Adjustment Filter Feed Hopper (400-HP-01)</b>					
Residence Time	min	90	90	3	METS Assumption
Slurry Flow	m <sup>3</sup> /h	4	5	2	METS Calculated Value
Volume	m <sup>3</sup>	6	7	2	METS Calculated Value
<b>pH Adjustment Filter Press (400-FL-01/02)</b>					
Type		Pressure	Pressure	3	METS Assumption
Number of Filter Units	#	1.00	2.00	3	METS Assumption
Feed Rate (per Unit)	dt/h	2.8	3.36	2	METS Calculated Value
% Solids					
Feed	w/w %	50	50	3	METS Assumption
Cake	w/w %	15%	15%	3	METS Assumption
Filtration Rate	kg/m <sup>2</sup> /h	80	80	3	METS Assumption
Filter Area (per Unit)	m <sup>2</sup>	18	21.0	2	METS Calculated Value
Filter Cake Discharge (wet)	t/h	3.3	3.95	2	METS Calculated Value
Solids Discharge	dt/h	2.8	3.36	2	METS Calculated Value
Cake Moisture	t/h	0.49	0.59	2	METS Calculated Value
<b>SX Feed Polishing Filter (400-FL-03/04/05)</b>					
Type		Polishing	Polishing	3	METS Assumption
Number of Filter Units	#	4.00	4.00	3	METS Assumption
Feed Rate (per Unit)	m <sup>3</sup> /h	409.9	491.9	2	METS Calculated Value
Filter Area (per Unit)	m <sup>2</sup>	TBC	TBC		
Filter Cake Discharge (wet)	t/h	TBC	TBC		
Solids Discharge	dt/h	TBC	TBC		
Cake Moisture	t/h	TBC	TBC	3	METS Assumption
Filtrate	m <sup>3</sup> /h	1,640	1,968	2	METS Calculated Value
<b>SX PLS Feed Tank (400-TK-02)</b>					
Residence Time	min	10	10	3	METS Assumption
PLS Flowrate	m <sup>3</sup> /h	1,640	1,968	2	METS Calculated Value
Volume	m <sup>3</sup>	274	329	2	METS Calculated Value
<b>Copper Extraction Mixer Settler (400-SX-01/02)</b>					
Number of Cells	#	2	2	3	METS Assumption
Volume/Cell Minimum (Mixer)	m <sup>3</sup>	82	98	2	METS Calculated Value
Volume/Cell Minimum (Settler)	m <sup>3</sup>	437	525	2	METS Calculated Value
Residence Time (Mixer)	min	1.50	1.50	3	METS Assumption
Residence Time (Settler)	min	8.00	8.00	3	METS Assumption
Feed Rate	m <sup>3</sup> /h	1,640	1,968	2	METS Calculated Value
O/A Ratio		1:1	1:1	3	METS Assumption
Organic in Solvent	%	15	15	3	METS Assumption

**J5329 - Deep-South - Haib Copper Project - Process Design Criteria**

Description	Units	Nominal	Design	Ref	Comments
Organic Feed Rate	m <sup>3</sup> /h	1,640	1,968	2	METS Calculated Value
LIX Loss Rate	m <sup>3</sup> /h	0.030	0.035	2	METS Calculated Value
Organic Makeup	m <sup>3</sup> /h	0.20	0.24	2	METS Calculated Value
Organic Diluent Loss Rate	m <sup>3</sup> /h	0.17	0.20	2	METS Calculated Value
Temperature	°C	Ambient	Ambient	3	METS Assumption
pH Initial		2.00	2.00	2	METS Calculated Value
Discharge Rate (Loaded Organic)	m <sup>3</sup> /h	1,640	1,968	2	METS Calculated Value
Organic Recovery	%	99.988%	99.988%	3	METS Assumption
Mixer Diameter		TBD	TBD		
Mixer Height		TBD	TBD		
Settler Width		TBD	TBD		
Settler Area Settler Length		TBD	TBD		
Copper Extraction	%	98%	98%	3	METS Assumption
Impurities Extraction	%	0%	0%	3	METS Assumption
<b>Loaded Organic Tank (400-TK-04)</b>					
Organic Feed	m <sup>3</sup> /h	1640	1968	2	METS Calculated Value
Residence Time	h	0.08	0.08	3	METS Assumption
Tank Capacity	m <sup>3</sup>	137	164		
<b>Copper Stripping Mixer Settler (400-SX-03/04)</b>					
Number of Cells	#	2	2	3	METS Assumption
Volume/Cell Minimum (Mixer)	m <sup>3</sup>	43	52	2	METS Calculated Value
Volume/Cell Minimum (Settler)	m <sup>3</sup>	232	278	2	METS Calculated Value
Residence Time (Mixer)	min	1.50	1.50	3	METS Assumption
Residence Time (Settler)	min	8.00	8.00	3	METS Assumption
Organic Feed Rate	m <sup>3</sup> /h	1,640	1,968	2	METS Calculated Value
O/A	-	16:1	16:1	3	METS Assumption
Stripping Solution Feed Rate	m <sup>3</sup> /h	96.6	115.9	3	METS Assumption
Temperature	°C	Ambient	Ambient	3	METS Assumption
Organic Discharge Rate	m <sup>3</sup> /h	1,640	1,968	2	METS Calculated Value
Aqueous Discharge Rate	m <sup>3</sup> /h	96.6	115.9	2	METS Calculated Value
H <sub>2</sub> SO <sub>4</sub> Concentration	g/L	200.00	200.00	3	METS Assumption
H <sub>2</sub> SO <sub>4</sub> (100%) Required	t/h	19.3	19.3	2	METS Calculated Value
H <sub>2</sub> SO <sub>4</sub> (100%) Recycled	t/h	18.4	18.4	2	METS Calculated Value
H <sub>2</sub> SO <sub>4</sub> (100%) Makeup	t/h	1.0	1.0	2	METS Calculated Value
Temperature	°C	Ambient	Ambient	3	METS Assumption
pH	pH	-0.61	-0.61	2	METS Calculated Value
Split to Electrowinning	%	100	100	3	METS Assumption
Stripping Efficiency	%	100	100	3	METS Assumption
<b>Organic Control Tank (400-TK-03)</b>					
Organic Feed	m <sup>3</sup> /h	1640	1968	2	METS Calculated Value
Residence Time	h	0.08	0.08	3	METS Assumption
Tank Capacity	m <sup>3</sup>	137	164	2	METS Calculated Value
<b>Stripping Liquor Makeup Tank (400-TK-05)</b>					
Feed	m <sup>3</sup> /h	96.6	116	2	METS Calculated Value
Residence Time	h	0.08	0.08	3	METS Assumption
Tank Capacity	m <sup>3</sup>	9	11	2	METS Calculated Value
<b>Copper Electrowinning Cells (400-EC-01---104)</b>					
Number of Cells	#	104	104	2	METS Calculated Value
Electrowin Time	days	TBD	TBD		
Cell Volume	m <sup>3</sup>	TBD	TBD		
Flowrate	m <sup>3</sup> /h	1.0	1.1	2	METS Calculated Value
Current Density	A/m <sup>2</sup>	282.0	282.0	3	METS Assumption
Cell Voltage	V	2.0	2.0	3	METS Assumption
Cathode Material	-	Stainless Steel Blank Cathodes		3	METS Assumption
Cathode Cleaning	-	High Pressure Water		3	METS Assumption
Cathode Cleaning Frequency	per week	1.0	1.0	3	METS Assumption
Water Requirement for Cathode Cleaning	m <sup>3</sup> /clean	15.0	18.00	3	METS Assumption
Electrowinning Efficiency	%	100		3	METS Assumption

**J5329 - Deep-South - Haib Copper Project - Process Design Criteria**

Description	Units	Nominal	Design	Ref	Comments
<b>Area 500- Iron Precipitation</b>					
<b>Iron Precipitation Tank (500-TK-01)</b>					
Number of Tanks	#	1.0		3	METS Assumption
pH		5.8		3	METS Assumption
Temperature	°C	40		3	METS Assumption
Feed Rate	t/h	656		2	METS Calculated Value
Lime Addition Rate	dt/h	0.8	0.9	2	METS Calculated Value
Lime Density	t/m <sup>3</sup>	1.2	1.2	3	METS Assumption
Limestone Addition Rate	dt/h	1.4	1.7	2	METS Calculated Value
Residence Time	h	0.2	0.2	2	METS Calculated Value
Discharge Rate	t/h	659	659.0	2	METS Calculated Value
Capacity	m <sup>3</sup>	110	132	3	METS Assumption
<b>Iron Precipitate Thickener (500-TH-01)</b>					
Type of Thickener	-		High Rate	3	METS Assumption
No. of Thickeners	#	1	1.00	3	METS Assumption
Feed Rate (Solids)	dt/h	65	78.30	2	METS Calculated Value
Feed Rate (Slurry)	m <sup>3</sup> /h	606	726.65	2	METS Calculated Value
Feed % Solids	w/w %	10.1	10.1	2	METS Calculated Value
Underflow % Solids	w/w %	50	50	3	METS Assumption
Underflow Solid Rate	dt/h	65	78.30	2	METS Calculated Value
Underflow Liquid	t/h	65	78.30	2	METS Calculated Value
Underflow Slurry Rate	t/h	130	156.60	2	METS Calculated Value
Underflow Slurry Rate	m <sup>3</sup> /h	89	106.26	2	METS Calculated Value
Underflow Density	t/m <sup>3</sup>	1.47	1.47	2	METS Calculated Value
Overflow % Solids	w/w %	0.00	0.00	3	METS Assumption
Overflow Solid Rate	dt/h	0.00	0.00	2	METS Calculated Value
Overflow Liquid	t/h	529	634.20	3	METS Assumption
Overflow Slurry Rate	t/h	529	634.20	2	METS Calculated Value
Overflow Slurry Rate	m <sup>3</sup> /h	529	634.20	2	METS Calculated Value
Overflow Density	t/m <sup>3</sup>	1.00	1.00	3	METS Assumption
Flocculant Dosage	g/t	100	100	3	METS Assumption
Floc Rate	kg/h	6.52	7.83	2	METS Calculated Value
Settling Rate	m <sup>2</sup> /t/d	6.00	6.00	3	METS Assumption
Thickener Cross Sectional Area (Minimum)	m <sup>2</sup>	391	469.79	2	METS Calculated Value
Thickener Diameter (Minimum)	m	22	26.79	2	METS Calculated Value
Upflow Rate	m/h	1.35	1.62	2	METS Calculated Value
Residence Time	h	TBD	TBD		
Thickener Volume	m <sup>3</sup>	TBD	TBD		
<b>Iron Tailings Filter Feed Tank (500-TK-02)</b>					
Residence Time	min	30	30	3	METS Assumption
Slurry Flow	m <sup>3</sup> /h	89	106	2	METS Calculated Value
Volume	m <sup>3</sup>	45	54	2	METS Calculated Value
<b>Iron Tailings Filter Press (500-FL-01/02)</b>					
Type	-	Pressure	TBD	3	METS Assumption
Number of Filter Units	#	2.00	2.00	3	METS Assumption
Feed Rate (per Unit)	dt/h	32.6	39.15	2	METS Calculated Value
% Solids					
Feed	w/w %	50	50	3	METS Assumption
Cake	w/w %	10	10	3	METS Assumption
Filtration Rate	kg/m <sup>2</sup> /h	80	80	3	METS Assumption
Filter Area (per Unit)	m <sup>2</sup>	204	244.7	2	METS Calculated Value
Filter Cake Discharge	wet t/h	76.8	92.12	2	METS Calculated Value
Solids Discharge	dt/h	65.2	78.30	2	METS Calculated Value
Cake Moisture	t/h	11.51	13.82	2	METS Calculated Value
<b>Raffinate Recycle Tank (500-TK-03)</b>					
Residence Time	minutes	5	5	3	METS Assumption
Flow from Filtrate	m <sup>3</sup> /h	77	92	2	METS Calculated Value
Flow From Thickener	m <sup>3</sup> /h	529	634	2	METS Calculated Value
Flow rate (Total)	m <sup>3</sup> /h	605	726	2	METS Calculated Value
Volume	m <sup>3</sup>	51	61	2	METS Calculated Value
<b>Area 600 - Process and Raw Water</b>					
<b>Raw Water Dam (600-DM-01/02)</b>					
Raw Water Requirement	m <sup>3</sup> /h	137	165	2	METS Calculated Value
Raw Water Requirement	m <sup>3</sup> /d	3,297	3,957	2	METS Calculated Value
Residence Time	d	5	5	3	METS Assumption
Storage Capacity	m <sup>3</sup>	16,500	19,800	2	METS Calculated Value
<b>Raw Water Tank (600-TK-02)</b>					
Raw Water Requirement	m <sup>3</sup> /h	137	165	2	METS Calculated Value
Raw Water Requirement	m <sup>3</sup> /d	3,297	3,957	2	METS Calculated Value
Residence Time	d	1	1	3	METS Assumption
Storage Capacity	m <sup>3</sup>	3,300	3,960	2	METS Calculated Value
<b>Process Water Tank (600-TK-01/03)</b>					
Process Water Drawdown	m <sup>3</sup> /h	60	72	3	METS Assumption
Raw Water Requirement	m <sup>3</sup> /h	15	18	3	METS Assumption
Residence Time	d	1	1	3	METS Assumption
Storage Capacity	m <sup>3</sup>	1,500	1,800	2	METS Calculated Value
<b>Raw Water</b>					
Supply Source		Orange River			
Analysis					
pH		TBD			
E Coli		TBD			
Copper	ppm	TBD			
Iron	ppm	TBD			
Cobalt	ppm	TBD			
Nickel	ppm	TBD			
TSS	ppm	TBD			
TDS	ppm	TBD			
Total Sulphate	ppm	TBD			

**J5329 - Deep-South - Haib Copper Project - Process Design Criteria**

Description	Units	Nominal	Design	Ref	Comments
<b>Potable Water Quality</b>					
pH	-	6.5-8	8.00		
Conductivity	µS/cm	TBD	5.80		
Total Dissolved Solids	mg/l	TBD	500		
Total Hardness as CaCO <sub>3</sub>	mg/l	TBD	200		
Na <sup>+</sup>	mg/l	TBD	180		
Cl <sup>-</sup>	mg/l	TBD	250		
Cl <sub>2</sub>	mg/l	TBD	5.00		
SO <sub>4</sub>	mg/l	TBD	250		
<b>Area 700- Reagents</b>					
<b>LIX-984N</b>					
Supply Method	-	Bulk		3	METS Assumption
Supply Form	-	Liquid		3	METS Assumption
Supply Bulk Density	t/m <sup>3</sup>	0.88	-	4	Market Specification
Storage Tank Residence Time	h	48	48.00	3	METS Assumption
Storage Tank Capacity	m <sup>3</sup>	2.00	2.40	2	METS Calculated Value
Mixing Tank Capacity	m <sup>3</sup>	1.00	1.20	2	METS Calculated Value
Mixing Tank Residence Time	h	5	5.00	3	METS Assumption
O in Solvent	%w/w	15	15.00	3	METS Assumption
Addition	m <sup>3</sup> /h	0.03	0.03	2	METS Calculated Value
Raw Diluent for Mixing	m <sup>3</sup> /h	0.17	0.17	2	METS Calculated Value
<b>Kerosene</b>					
Supply Method	-	Bulk		3	METS Assumption
Supply Form	-	Liquid		3	METS Assumption
Supply Bulk Density	t/m <sup>3</sup>	0.81		3	METS Assumption
Kerosene Process Feed	m <sup>3</sup> /h	0.17	0.20	2	METS Calculated Value
Storage Residence Time	h	24	24	3	METS Assumption
Storage Tank Capacity	m <sup>3</sup>	5.00	6.00	2	METS Calculated Value
<b>Quicklime</b>					
Supply Method	-	Bulk		3	METS Assumption
Supply Form	-	Solid		3	METS Assumption
Supply Density	t/m <sup>3</sup>	3.35		7	Other Sources
Supply Bulk Density	t/m <sup>3</sup>	0.88		7	Other Sources
Storage Residence Time	h	24	-	3	METS Assumption
Process Lime Requirement	t/h	0.78	0.93	2	METS Calculated Value
Raw Water for Mixing	m <sup>3</sup> /h	2.33	2.80	2	METS Calculated Value
Storage Silo Volume	m <sup>3</sup>	22.0	26.40	2	METS Calculated Value
Distribution Tank Residence Time	h	1	1	3	METS Assumption
Distribution Tank Volume	m <sup>3</sup>	3.00	3.60	2	METS Calculated Value
% Solids	%w/w	25%	25%	3	METS Assumption
<b>Limestone/Calcrete</b>					
Supply Method	-	Bulk		3	METS Assumption
Supply Form	-	Solid		3	METS Assumption
Supply Density	t/m <sup>3</sup>	2.60		7	Other Sources
Storage Residence Time	h	24	-	3	METS Assumption
Process Lime Requirement	t/h	3.45	4.14	2	METS Calculated Value
Raw Water for Mixing	m <sup>3</sup> /h	10.34	12.41	2	METS Calculated Value
Storage Silo Volume	m <sup>3</sup>	32.0	38.40	2	METS Calculated Value
Distribution Tank Residence Time	h	1	1	3	METS Assumption
Distribution Tank Volume	m <sup>3</sup>	12.00	14.40	2	METS Calculated Value
% Solids	%w/w	25%	25%	3	METS Assumption
<b>Sulphuric Acid</b>					
Supply Method	-	Bulk Tanker		3	METS Assumption
Supply Form	-	Liquid		3	METS Assumption
H <sub>2</sub> SO <sub>4</sub> Density	t/m <sup>3</sup>	1.84		3	METS Assumption
H <sub>2</sub> SO <sub>4</sub> Process Requirement	t/h	1.04	-	2	METS Calculated Value
H <sub>2</sub> SO <sub>4</sub> Process Requirement	m <sup>3</sup> /h	0.57	0.68	2	METS Calculated Value
H <sub>2</sub> SO <sub>4</sub> Storage Residence Time	h	24	24	3	METS Assumption
H <sub>2</sub> SO <sub>4</sub> Storage Tank Capacity	m <sup>3</sup>	14	16.80	2	METS Calculated Value
<b>Binder</b>					
Supply Method	-	Bulk Bag		3	METS Assumption
Supply Form	-	Solid		3	METS Assumption
Supply Bulk Density	t/m <sup>3</sup>	2.00		3	METS Assumption
Storage Residence Time	h	12	-	3	METS Assumption
Binder Consumption	kg/t	0.50		3	METS Assumption
Process Requirement	t/h	0.2	0.19	2	METS Calculated Value
Binder Feed Hopper Capacity	m <sup>3</sup>	1.0	1.20	2	METS Calculated Value
<b>Flocculant</b>					
Type	-	Magnafloc 155		3	METS Assumption
Supply Method	-	25 kg Bags		3	METS Assumption
Supply Form	-	Solid		3	METS Assumption
Flocculant Mixing Tank Residence Time	h	2	-	3	METS Assumption
Flocculant Storage Tank Residence Time	h	24	-	3	METS Assumption
Flocculant Mixing Tank Capacity	L	10		2	METS Calculated Value
Flocculant Storage Tank Capacity	m <sup>3</sup>	1		2	METS Calculated Value
Bulk Density	t/m <sup>3</sup>	0.75		7	Other Sources
Total Addition Rate	kg/h	6.81	8.17	3	METS Assumption
Addition Concentration	%w/v	25	25	3	METS Assumption
Inline Mixer Dilution	%w/v	2.5	2.5	3	METS Assumption
Viscosity (After dilution)	cP	300	300	3	METS Assumption
Addition Concentration (Belt Filter)	%w/v	25	25	3	METS Assumption
Raw Water for Mixing	m <sup>3</sup> /h	0.0004	0.0004	2	METS Calculated Value
<b>Area 800- Services</b>					
<b>Air Compressor</b>					
HP Air Compressor Type	-	Screw		3	METS Assumption
HP Air Pressure	kPa	750		3	METS Assumption
HP Air Compressor Capacity	Nm <sup>3</sup> /h	250	300	3	METS Assumption
<b>Plant Air Filter</b>					

**J5329 - Deep-South - Haib Copper Project - Process Design Criteria**

	Description	Units	Nominal	Design	Ref	Comments
	Type					
	<b>Plant Air Receiver</b>					
	Type	-	Standard Receiver Vessel		3	METS Assumption
	HP Air Receiver Volume	L			3	METS Assumption
	<b>Instrument Air</b>					
	Instrument Air Pressure	kPa	750		3	METS Assumption
	HP Air Compressor Capacity	m <sup>3</sup> /h				

**J5329 - Deep-South - Haib Copper Project - Process Design Criteria**

Description	Units	Nominal	Design	Ref	Comments	
<b>Site Characteristics</b>						
<b>Haib Copper Project</b>						
Latitude	-	28°41'29" S	28°41'29" S			
Longitude	-	17°51'18" E	17°51'18" E			
Elevation	masl	157	157	1	Noordoewer (closest town)	
Mean Annual Rainfall	mm/a	25.50	25.50	1		
Highest 24 Hour Rainfall Event	mm	47.0	47.0	1		
Winter Dry Bulb Temperature	°C	15.8	15.8	1		
Winter Wet Bulb Temperature	°C	15.8	15.8	1	Temperature at Windhoek	
Summer Dry Bulb Temperature	°C	40.0	40.0	1	Namibia desert Max temp	
Summer Wet Bulb Temperature	°C	35.0	35.0	1		
Summer Daily Range Temperature	°C	20.00	20.00	1		
Maximum Wind Velocity	km/h	15.8	15.8	1	Source: Namibia Weather 2019	
<b>Operating Criteria</b>						
<b>Haib Copper Project</b>						
Resource	Mt	456.9	456.9	1	Client Supplied Data	
Estimated Project Life	yr	54	45	3	METS Assumption	
Days per Year	Days	365	365	7	Other Sources	
Hours per Day	h	24	24	7	Other Sources	
Crusher Availability	%	70%	70%	3	METS Assumption	
Plant Availability	%	90%	90%	3	METS Assumption	
Heap Leach Availability	%	98%	98%	3	METS Assumption	
Plant Utilisation	%	90%	90%	3	METS Assumption	
Feed Moisture	%	3%	3%	3	METS Assumption	
Plant Throughput	t/a	8,500,000	10,200,000	3	METS Assumption	
Plant Throughput	t/h	1,078	1,284	2	METS Calculated Value	
Crusher Throughput	t/h	1,386	1,663	2	METS Calculated Value	
Crusher Operating Hours per Annum	h	6,132	6,132	3	METS Assumption	
Plant Operating Hours per Annum	h	7884	7884	1	Client Supplied Data	
Average Copper Head Grade	%	0.310	0.310	1	Client Supplied Data	
Overall Copper Recovery	%	85	85	2	METS Calculated Value	
Copper Recovered per Annum	t/yr	21,708	26,855	2	METS Calculated Value	
<b>Comminution Characteristics</b>						
Abrasion Index (AI)	-	0.49	0.49	1	Client Supplied Data	
Ore Density	t/m <sup>3</sup>	2.8	2.8	1	Client Supplied Data	
Ore Bulk Density	t/m <sup>3</sup>	1.8	1.8	1	Client Supplied Data	
Crushing Work Index (CWI)	kWh/t	22.3	22.3	1	Client Supplied Data	
Bond Ball Mill Work Index (BWI)	kWh/t	18.0	18.0	1	Client Supplied Data	
Bond Rod Mill Work Index (RWI)	kWh/t	21.6	21.6	1	Client Supplied Data	
Angle of Repose	degrees	36	36	1	Client Supplied Data	
Angle of Reclaim	degrees	55	55	1	Client Supplied Data	
<b>Area 100- Primary and Secondary Crushing</b>						
<b>Crushing Design Basis</b>						
Throughput Operating	t/h	1,386	1,663	2	METS Calculated Value	
<b>Plant Feed Size</b>						
ROM Feed Size	F <sub>100</sub> mm	800	800	3	METS Assumption	
<b>Crushing Product Size</b>						
Screen Undersize	P <sub>20</sub> mm	5.8	5.7	3	METS Assumption	
<b>ROM Bin (100-BN-01)</b>						
Residence Time	h	0.25	0.25	3	METS Assumption	
Capacity	t	347	416	2	METS Calculated Value	
Volume	m <sup>3</sup>	124	148	2	METS Calculated Value	
<b>Gyratory Crusher (100-CR-01)</b>						
Configuration	Open Circuit					
Type	Sandvik CG810i					
Number of Units		1	1	3	METS Assumption	
Feed Rate	t/h	1,386	1,663	2	METS Calculated Value	
Feed Size	F <sub>80</sub> mm	495	495	2	METS Calculated Value	
Product Size	P <sub>20</sub> mm	137	137	2	METS Calculated Value	
Closed Setting	mm	160	160	2	METS Calculated Value	
Stroke	mm	32	32	2	METS Calculated Value	
Crusher Power Rating	kW	500	500	6	Vendor Supplied Data	
<b>Gyratory Crusher Discharge Conveyor (100-CV-01)</b>						
Feed Rate	t/h	1,386	1,663	2	METS Calculated Value	
<b>Cone Crusher Feed Bins (100-BN-02/03)</b>						
Combined Throughput	t/h	2,284	2,792	2	METS Calculated Value	
Units	-	2	2	3	METS Assumption	
Residence Time	h	0.50	0.50	3	METS Assumption	
Capacity per Bin	t	571	698	2	METS Calculated Value	
Volume per Bin	m <sup>3</sup>	317	388	2	METS Calculated Value	
<b>Cone Crushers (100-CR-02/03)</b>						
Type	Sandvik CH870i-03					
No. of Units	#	2	2	3	METS Assumption	
Cavity Type	Standard					
Feed Rate	Per Unit	t/h	1,142	1,396	2	METS Calculated Value
Feed Size	F <sub>80</sub> mm	115	114	2	METS Calculated Value	
Product Size	P <sub>20</sub> mm	40	46	2	METS Calculated Value	
Closed Size Setting	mm	32	38	3	METS Assumption	



**J5329 - Deep-South - Haib Copper Project - Process Design Criteria**

Description	Units	Nominal	Design	Ref	Comments
Power Rating	Per Unit	kW	746	746	6 Vendor Supplied Data
<b>Cone Crusher Screen (100-SC-01)</b>					
Type			Metso TS6.2 Double-Deck Banana		
Feed Rate	t/h	2,284	2,792	2	METS Calculated Value
Screen Area	m <sup>2</sup>	25	25	6	Vendor Supplied Data
No. of Units	#	1	1	3	METS Assumption
Product Size	P <sub>80</sub> mm	24.2	27.1	2	METS Calculated Value
Screen Flow Rates	O/S	t/h	1,129	2	METS Calculated Value
	U/S	t/h	1,386	2	METS Calculated Value
Deck 1 Screen Aperture	mm	50	60	3	METS Assumption
Deck 2 Screen Aperture	mm	35	40	3	METS Assumption
<b>Crushed Ore Stockpile</b>					
Ore Delivery			Conveyor		
Feed Rate	t/h	1,386	1,663	2	METS Calculated Value
Number of Reclaim Chutes	#	2	2	3	METS Assumption
Live Stockpile Residence Time	h	12	12	3	METS Assumption
Live Stockpile Capacity	t	16,634	19,961	2	METS Calculated Value
Live Stockpile Volume	m <sup>3</sup>	9,241	11,085	2	METS Calculated Value
Total Stockpile Volume	m <sup>3</sup>	36,965	44,357	3	METS Assumption
Stockpile Diameter	m	36	39	2	METS Calculated Value
<b>Crushing Plant to the Processing Plant Conveyor (100-CV-07)</b>					
Feed Rate	t/h	1,386	1,663	2	METS Calculated Value
Length	m	TBD	TBD		
<b>Area 200- Tertiary Crushing</b>					
<b>HPGR Feed Stockpile</b>					
Ore Delivery			Conveyor		
Feed Rate	t/h	1,386	1,663	2	METS Calculated Value
Discharge Chutes	#	2	2	3	METS Assumption
Discharge Rate	t/h	1,078	1,294	2	METS Calculated Value
Live Stockpile Residence Time	h	48	48	3	METS Assumption
Live Stockpile Capacity	t	51,750	62,100	2	METS Calculated Value
Live Stockpile Volume	m <sup>3</sup>	28,750	34,500	2	METS Calculated Value
Total Stockpile Volume	m <sup>3</sup>	115,001	138,001	2	METS Calculated Value
Stockpile Diameter	m	53	57	2	METS Calculated Value
<b>HPGR Design Basis</b>					
Availability	%	90.00	90.00	3	METS Assumption
Throughput	t/h	1,078	1,294	2	METS Calculated Value
Fresh Feed Size	mm	24.20	27.10	2	METS Calculated Value
<b>HPGR Feed Bin (200-BN-01/02)</b>					
Fresh Feed	t/h	1,078	1,294	2	METS Calculated Value
Units	-	2	2	3	METS Assumption
Recycle to Fresh Feed Ratio	%	30	30	3	METS Assumption
Recycle Rate	t/h	323	388	2	METS Calculated Value
Feed Rate Total	t/h	1402	1682	2	METS Calculated Value
Residence Time	h	0.17	0.17	3	METS Assumption
Capacity per Bin	t	117	140	2	METS Calculated Value
Volume per Bin	m <sup>3</sup>	65	78	2	METS Calculated Value
<b>HPGR (200-GR-01/02)</b>					
Vendor			Koppers		
Type			630-17.6-ONH 1230 PG1E		
Number	#	2,00	2,00	6	Vendor Supplied Data
Roll Speed	m/s	1.70	1.70	6	Vendor Supplied Data
Roll Length	mm	1000	1000	6	Vendor Supplied Data
Roll Diameter	mm	1700	1700	6	Vendor Supplied Data
Feed Rate (per Unit)	t/h	701	841	2	METS Calculated Value
Feed Size	F <sub>80</sub> mm	22.10	24.20	3	METS Assumption
Product Size	P <sub>80</sub> mm	10.80	11.20	3	METS Assumption
Power Rating	kW	1,800	1,800	3	METS Assumption
<b>HPGR Screen (200-SC-02)</b>					
Type			Metso TS6.2 Double-Deck Banana	3	METS Assumption
Feed Rate	t/h	1402	1682	2	METS Calculated Value
Screen Area	m <sup>2</sup>	50	50	6	Vendor Supplied Data
No. of Units	#	2	2	3	METS Assumption
Product Size - P80	mm	5.8	5.7	3	METS Assumption
Screen Flow Rates	O/S	t/h	388	2	METS Calculated Value
	U/S	t/h	1078	2	METS Calculated Value
Screen Aperture	Top	mm	15	3	METS Assumption
	Middle	mm	10	3	METS Assumption
% Reporting to U/S	%	70	70	3	METS Assumption
<b>Area 300- Agglomeration and Heap Leaching</b>					
<b>Leaching Design Basis</b>					
Feed Rate Solids	dt/h	1046	1255	2	METS Calculated Value
Feed Rate	t/h	1078	1294	2	METS Calculated Value
Feed % Solids	ww %	88.0	88.0	3	METS Assumption
Acid Consumption Rate	kg/t ore	10	10	3	METS Assumption
Barren Pond H <sub>2</sub> SO <sub>4</sub> Concentration	g/L	2.3	2.3	2	METS Calculated Value
Solution pH	-	1.33	1.33	2	METS Calculated Value
Total Acid Solution Rate	m <sup>3</sup> /h	1625	1949	2	METS Calculated Value
Binder Addition	kg/t	0.16	0.16	3	METS Assumption



Client Deep-South Resources  
 Project Haib Copper Project  
 Job # J5329  
 Doc # J5329-P-PDC-000-001  
 Doc Title Process Design Criteria 8.5 Mtpa @ 85% Cu Recovery+CuSO4  
 Rev A

**J5329 - Deep-South - Haib Copper Project - Process Design Criteria**

Description	Units	Nominal	Design	Ref	Comments
Leach Extent Cu	%	85	85	5	Testwork Supplied Data
Leach Extent Al	%	8	8	5	Testwork Supplied Data
Leach Extent Fe	%	68	68	5	Testwork Supplied Data
Temperature	°C	40	40	3	METS Assumption
Total Heap Irrigation Time	days	400	400	3	METS Assumption
Heap Evaporation Losses	%	2	2	3	METS Assumption
Pond Evaporation Losses	mm/day	8	8	3	METS Assumption
<b>Irrigation (300-IR-01-03)</b>					
Number of Leach Stages	#	3.00	3.00	3	METS Assumption
Irrigation Solution		Dilute Sulphuric Acid		3	METS Assumption
Irrigation Rate	L/h/m <sup>2</sup>	10.00	10.00	3	METS Assumption
Irrigation Type		Droppers		3	METS Assumption
Irrigation Solution Density	t/m <sup>3</sup>	1.00	1.00	3	METS Assumption
<b>Agglomerator Feed Bin (300-BN-01)</b>					
Residence Time	min	15	15	3	METS Assumption
Wet Solids Flow	m <sup>3</sup> /h	599	719	2	METS Calculated Value

**J5329 - Deep-South - Haib Copper Project - Process Design Criteria**

Description	Units	Nominal	Design	Ref	Comments
Volume	m <sup>3</sup>	150	180	2	METS Calculated Value
<b>Agglomeration Drum (300-AD-01/02)</b>					
Model/Type	-	Rotary Drum		6	Vendor Supplied Data
No. of Drums	#	2	2	3	METS Assumption
Feed Rate	dt/h	1,046	1,255	2	METS Calculated Value
Feed Rate	t/h Wet	1,078	1,294	2	METS Calculated Value
Water Addition	t/h	110.2	132.3	2	METS Calculated Value
Feed Rate	per Unit t/h	594.2	713.0	2	METS Calculated Value
Total Mass Feed Rate	m <sup>3</sup> /h	709.2	851.0	2	METS Calculated Value
Percent Fill	%	20%	20%	3	METS Assumption
Void Volume	%	50%	50%	3	METS Assumption
Binder Addition	t/h	0.2	0.2	2	METS Calculated Value
Sulphuric Acid Addition	t/h	0.1	0.1	2	METS Calculated Value
Solids Content	%	88	88.0	3	METS Assumption
Residence Time	h	0.02	0.02	3	METS Assumption
Drum Minimum Volume	m <sup>3</sup>	70.9	85.1	2	METS Calculated Value
Drum Designed Volume	m <sup>3</sup>	141.8	170.2	2	METS Calculated Value
Solids Discharge Rate	dt/h	1,046	1,255.1	2	METS Calculated Value
Wet Solids Discharge Rate	t/h	1,189	1,426.3	2	METS Calculated Value
Wet Solids Bulk Density	t/m <sup>3</sup>	2.0	2.0	3	METS Assumption
<b>Primary Heap</b>					
Ore Delivery	-	Radial Stacker		3	METS Assumption
Feed Rate	t/h	1189	1426	2	METS Calculated Value
Irrigation Rate	L/h/m <sup>2</sup>	10.00	10.00	3	METS Assumption
Irrigation Solution	-	ILS	ILS	3	METS Assumption
Temperature	°C	40.00	40.00	3	METS Assumption
Irrigation Solution pH	-	TBD	TBD	3	METS Assumption
Heap Moisture	%	12	12	3	METS Assumption
Live Stockpile	days	120	120	3	METS Assumption
Live Stockpile Capacity	t	3,354,633	3,354,633	2	METS Calculated Value
Leach Extent Cu	%	TBD	TBD		
Leach Extent Mo	%	TBD	TBD		
Leach Extent Al	%	TBD	TBD		
Leach Extent Fe	%	TBD	TBD		
Leachant Discharge Rate	m <sup>3</sup> /h	1,625	1,949	2	METS Calculated Value
Heap Lift Height	m	10.0	10.0	3	METS Assumption
Heap Width	m	40.00	40.00	2	METS Calculated Value
Heap Length	m	120.00	120.00	2	METS Calculated Value
Heap Height	m	36.00	36.00	2	METS Calculated Value
Heap Evaporation Losses	%	2	2	3	METS Assumption
<b>Secondary Heap</b>					
Irrigation Rate	L/h/m <sup>2</sup>	10.00	10.00	3	METS Assumption
Irrigation Solution	-	Barren	Barren	3	METS Assumption
Temperature	°C	40.00	40.00	3	METS Assumption
Irrigation Solution pH	-	TBD	TBD	3	METS Assumption
Heap Moisture	%	12	12	3	METS Assumption
Live Stockpile	days	120	120	3	METS Assumption
Live Stockpile Capacity	t	3,354,633	3,354,633	2	METS Calculated Value
Leach Extent Cu	%	TBD	TBD		
Leach Extent Mo	%	TBD	TBD		
Leach Extent Al	%	TBD	TBD		
Leach Extent Fe	%	TBD	TBD		
Leachant Discharge Rate	m <sup>3</sup> /h	1,625	1,949	2	METS Calculated Value
Heap Lift Height	m	10.00	12.00	3	METS Assumption
Heap Width	m	40.00	40.00	2	METS Calculated Value
Heap Length	m	120.00	120.00	2	METS Calculated Value
Heap Height	m	36.00	36.00	2	METS Calculated Value
Heap Evaporation Losses	%	2	2	3	METS Assumption
<b>Washing Heap</b>					
Irrigation Rate	L/h/m <sup>2</sup>	10.00	10.00	3	METS Assumption
Irrigation Solution	-	Barren	Barren	3	METS Assumption
Temperature	°C	40.00	40.00	5	Testwork Supplied Data
Irrigation Solution pH	-	TBD	TBD	3	METS Assumption
Heap Moisture	%	12	12	3	METS Assumption
Live Stockpile	days	180	180	2	METS Calculated Value
Live Stockpile Capacity	t	4,472,845	4,472,845	3	METS Assumption
Leach Extent Cu	%	TBD	TBD		
Leach Extent Mo	%	TBD	TBD		
Leach Extent Al	%	TBD	TBD		
Leach Extent Fe	%	TBD	TBD		
Leachant Discharge Rate	m <sup>3</sup> /h	2,166	2,599	2	METS Calculated Value
Heap Lift Height	m	10.00	12.00	3	METS Assumption
Heap Width	m	40.00	40.00	2	METS Calculated Value
Heap Length	m	120.00	120.00	2	METS Calculated Value
Heap Height	m	36.00	36.00	2	METS Calculated Value
Heap Evaporation Losses	%	2	2	3	METS Assumption
<b>Active Solution Pond (300-PD-03)</b>					
Volume/pad	m <sup>3</sup>	39,000	46,800	2	METS Calculated Value
Feed Rate (98% operating basis)	m <sup>3</sup> /h	2,166	2,599	2	METS Calculated Value
Solution pH	-	1.21	1.21	2	METS Calculated Value
Temperature	°C	40.00	40.00	3	METS Assumption
Loss From Evaporation	m <sup>3</sup> /h	2.60	3.12	2	METS Calculated Value



Client Deep-South Resources  
 Project Haib Copper Project  
 Job # J5329  
 Doc # J5329-P-PDC-000-001  
 Doc Title Process Design Criteria 8.5 Mtpa @ 85% Cu Recovery+CuSO4  
 Rev A

**J5329 - Deep-South - Haib Copper Project - Process Design Criteria**

Description	Units	Nominal	Design	Ref	Comments
Discharge Rate (90% operating basis)	m <sup>3</sup> /h	1,642	1,971	2	METS Calculated Value
<b>ILS Pond (300-PD-02)</b>					
Volume/pad	m <sup>3</sup>	39,000	46,800	2	METS Calculated Value
Feed Rate	m <sup>3</sup> /h	2,166	2,599	2	METS Calculated Value
pH		TBD	TBD		
Temperature	°C	40	40	3	METS Assumption
Loss From Evaporation	m <sup>3</sup> /h	2,60	3,12	2	METS Calculated Value
Discharge Rate	m <sup>3</sup> /h	2,166	2,599	2	METS Calculated Value
<b>Barren Pond (300-PD-01)</b>					
Volume/pad	m <sup>3</sup>	39,000	46,800	2	METS Calculated Value
SX Return Feed Rate (90% operating basis)	m <sup>3</sup> /h	1,566	1,879	2	METS Calculated Value
Acid Addition (98% operating basis)	t/h	0.0	0.0	2	METS Calculated Value
Water Addition (98% operating basis)	t/h	186	186	2	METS Calculated Value
pH		1.27	1.27	2	METS Calculated Value
Temperature	°C	40	40	3	METS Assumption
Loss From Evaporation	m <sup>3</sup> /h	2,60	3,12	2	METS Calculated Value
Discharge Rate to Secondary Heap (98% operating basis)	m <sup>3</sup> /h	2,166	2,599	2	METS Calculated Value
<b>Piping and Materials</b>					
Pad Liner Material		1.5 mm HDPE with Thermal Welds		3	METS Assumption
Barren/ILS /PLS /Raffinate Return Piping		HDPE Piping		3	METS Assumption
<b>Area 400- Copper SX and Electrowinning</b>					
<b>Circuit Configuration</b>					
Number of Trains	#	1.00	1.00	2	METS Calculated Value
Configuration		2E x 2S x 1SC	2E x 2S x 1SC	2	METS Calculated Value
Contacting Units		mixer settlers, single distributor and 3 picket fences		3	METS Assumption
Availability	days	7,884	7,884	3	METS Assumption
<b>pH Adjustment Tank (400-TK-01)</b>					
Feed	m <sup>3</sup> /h	1,642	1,971	2	METS Calculated Value
pH Feed	pH	1.21	1.21	2	METS Calculated Value
pH Discharge	pH	2	2	2	METS Calculated Value
Limestone/Calcrete Added	t/h	2	2	2	METS Calculated Value
Residence Time	h	0.08	0.08	3	METS Assumption
Tank Capacity	m <sup>3</sup>	137	164	2	METS Calculated Value
<b>pH Adjustment Thickener (400-TH-01)</b>					
Type of Thickener		High Rate		3	METS Assumption
No. of Thickeners	#	1	1.00	3	METS Assumption
Feed Rate (Solids)	dt/h	3	3.36	2	METS Calculated Value
Feed Rate (Slurry)	m <sup>3</sup> /h	1,643	1,943.48	2	METS Calculated Value
Feed % Solids	w/w %	0.2	0.2	2	METS Calculated Value
Underflow % Solids	w/w %	50	50	3	METS Assumption
Underflow Solid Rate	dt/h	3	3.36	2	METS Calculated Value
Underflow Liquid	t/h	3	3.36	2	METS Calculated Value
Underflow Slurry Rate	t/h	6	6.72	2	METS Calculated Value
Underflow Slurry Rate	m <sup>3</sup> /h	4	4.56	2	METS Calculated Value
Underflow Density	t/m <sup>3</sup>	1.47	1.47	2	METS Calculated Value
Overflow % Solids	w/w %	0.00	0.00	3	METS Assumption
Overflow Solid Rate	dt/h	0.00	0.00	2	METS Calculated Value
Overflow Liquid	t/h	1,640	1,967.62	3	METS Assumption
Overflow Slurry Rate	t/h	1,640	1,967.62	2	METS Calculated Value
Overflow Slurry Rate	m <sup>3</sup> /h	1,640	1,967.62	2	METS Calculated Value
Overflow Density	t/m <sup>3</sup>	1.00	1.00	3	METS Assumption
Flocculant Dosage	g/t	100	100	3	METS Assumption
Floc Rate	kg/h	0.28	0.34	2	METS Calculated Value
Settling Rate	m <sup>2</sup> /h	6.00	6.00	3	METS Assumption
Thickener Cross Sectional Area (Minimum)	m <sup>2</sup>	17	20.17	2	METS Calculated Value
Thickener Diameter (Minimum)	m	5	5.55	2	METS Calculated Value
Upflow Rate	m/h	97.57	117.08	2	METS Calculated Value
Residence Time	h	TBD	TBD		
Thickener Volume	m <sup>3</sup>	TBD	TBD		
<b>pH Adjustment Filter Feed Hopper (400-HP-01)</b>					
Residence Time	min	90	90	3	METS Assumption
Slurry Flow	m <sup>3</sup> /h	4	5	2	METS Calculated Value
Volume	m <sup>3</sup>	6	7	2	METS Calculated Value
<b>pH Adjustment Filter Press (400-FL-01/02)</b>					
Type		Pressure	Pressure	3	METS Assumption
Number of Filter Units	#	2.00	2.00	3	METS Assumption
Feed Rate	(per Unit) dt/h	2.8	3.36	2	METS Calculated Value
% Solids					
Feed	w/w %	50	50	3	METS Assumption
Cake	w/w %	5%	5%	3	METS Assumption
Filtration Rate	kg/m <sup>2</sup> /h	80	80	3	METS Assumption
Filter Area	(per Unit) m <sup>2</sup>	18	21.0	2	METS Calculated Value
Filter Cake Discharge	wet t/h	3.3	3.95	2	METS Calculated Value
Solids Discharge	dt/h	2.8	3.36	2	METS Calculated Value
Cake Moisture	t/h	0.49	0.59	2	METS Calculated Value
<b>SX Feed Polishing Filter (400-FL-03/04/05)</b>					
Type		Polishing	Polishing	3	METS Assumption
Number of Filter Units	#	4.00	4.00	3	METS Assumption
Feed Rate	(per Unit) m <sup>3</sup> /h	409.9	491.9	2	METS Calculated Value

**J5329 - Deep-South - Haib Copper Project - Process Design Criteria**

Description	Units	Nominal	Design	Ref	Comments
Filter Area (per Unit)	m <sup>2</sup>	TBC	TBC		
Filter Cake Discharge (wet)	t/h	TBC	TBC		
Solids Discharge	dt/h	TBC	TBC		
Cake Moisture	t/h	TBC	TBC	3	METS Assumption
Filtrate	m <sup>3</sup> /h	1,640	1,968	2	METS Calculated Value
<b>SX PLS Feed Tank (400-TK-02)</b>					
Residence Time	min	10	10	3	METS Assumption
PLS Flowrate	m <sup>3</sup> /h	1,640	1,968	2	METS Calculated Value
Volume	m <sup>3</sup>	274	329	2	METS Calculated Value
<b>Copper Extraction Mixer Settler (400-SX-01/02)</b>					
Number of Cells	#	2	2	3	METS Assumption
Volume/Cell Minimum (Mixer)	m <sup>3</sup>	82	98	2	METS Calculated Value
Volume/Cell Minimum (Settler)	m <sup>3</sup>	437	525	2	METS Calculated Value
Residence Time (Mixer)	min	1.50	1.50	3	METS Assumption
Residence Time (Settler)	min	8.00	8.00	3	METS Assumption
Feed Rate	m <sup>3</sup> /h	1,640	1,968	2	METS Calculated Value
O/A Ratio		1:1	1:1	3	METS Assumption
Organic in Solvent	%	15	15	3	METS Assumption
Organic Feed Rate	m <sup>3</sup> /h	1,640	1,968	2	METS Calculated Value
LIX Loss Rate	m <sup>3</sup> /h	0.030	0.035	2	METS Calculated Value
Organic Makeup	m <sup>3</sup> /h	0.20	0.24	2	METS Calculated Value
Organic Diluent Loss Rate	m <sup>3</sup> /h	0.17	0.20	2	METS Calculated Value
Temperature	°C	Ambient	Ambient	3	METS Assumption
pH Initial		2.00	2.00	2	METS Calculated Value
Discharge Rate (Loaded Organic)	m <sup>3</sup> /h	1,640	1,968	2	METS Calculated Value
Organic Recovery	%	99.988%	99.988%	3	METS Assumption
Mixer Diameter		TBD	TBD		
Mixer Height		TBD	TBD		
Settler Width		TBD	TBD		
Settler Area Settler Length		TBD	TBD		
Copper Extraction	%	98%	98%	3	METS Assumption
Impurities Extraction	%	0%	0%	3	METS Assumption
<b>Loaded Organic Tank (400-TK-04)</b>					
Organic Feed	m <sup>3</sup> /h	1640	1968	2	METS Calculated Value
Residence Time	h	0.08	0.08	3	METS Assumption
Tank Capacity	m <sup>3</sup>	137	164		
<b>Copper Stripping Mixer Settler (400-SX-03/04)</b>					
Number of Cells	#	2	2	3	METS Assumption
Volume/Cell Minimum (Mixer)	m <sup>3</sup>	43	52	2	METS Calculated Value
Volume/Cell Minimum (Settler)	m <sup>3</sup>	232	278	2	METS Calculated Value
Residence Time (Mixer)	min	1.50	1.50	3	METS Assumption
Residence Time (Settler)	min	8.00	8.00	3	METS Assumption
Organic Feed Rate	m <sup>3</sup> /h	1,640	1,968	2	METS Calculated Value
O/A		16:1	16:1	3	METS Assumption
Stripping Solution Feed Rate	m <sup>3</sup> /h	96.6	115.9	3	METS Assumption
Temperature	°C	Ambient	Ambient	3	METS Assumption
Organic Discharge Rate	m <sup>3</sup> /h	1,640	1,968	2	METS Calculated Value
Aqueous Discharge Rate	m <sup>3</sup> /h	96.6	115.9	2	METS Calculated Value
H <sub>2</sub> SO <sub>4</sub> Concentration	g/L	200.00	200.00	3	METS Assumption
H <sub>2</sub> SO <sub>4</sub> (100%) Required	t/h	19.3	19.3	2	METS Calculated Value
H <sub>2</sub> SO <sub>4</sub> (100%) Recycled	t/h	0.0	0.0	2	METS Calculated Value
H <sub>2</sub> SO <sub>4</sub> (100%) Makeup	t/h	3.3	3.3	2	METS Calculated Value
Temperature	°C	Ambient	Ambient	3	METS Assumption
pH		-0.61	-0.61	2	METS Calculated Value
Split to Electrowinning	%	100	100	3	METS Assumption
Stripping Efficiency	%	100	100	3	METS Assumption
<b>Organic Control Tank (400-TK-03)</b>					
Organic Feed	m <sup>3</sup> /h	1640	1968	2	METS Calculated Value
Residence Time	h	0.08	0.08	3	METS Assumption
Tank Capacity	m <sup>3</sup>	137	164	2	METS Calculated Value
<b>Stripping Liquor Makeup Tank (400-TK-05)</b>					
Feed	m <sup>3</sup> /h	96.6	116	2	METS Calculated Value
Residence Time	h	0.08	0.08	3	METS Assumption
Tank Capacity	m <sup>3</sup>	9	11	2	METS Calculated Value
<b>Copper Electrowinning Cells (400-EC-01--08)</b>					
Number of Cells	#	88	88	2	METS Calculated Value
Electrowin Time	days	TBD	TBD		
Cell Volume	m <sup>3</sup>	TBD	TBD		
Flowrate	m <sup>3</sup> /h	0.5	0.5	2	METS Calculated Value
Current Density	A/m <sup>2</sup>	282.0	282.0	3	METS Assumption
Cell Voltage	V	2.0	2.0	3	METS Assumption
Cathode Material		Stainless Steel Blank Cathodes		3	METS Assumption
Cathode Cleaning		High Pressure Water		3	METS Assumption
Cathode Cleaning Frequency	per week	1.0	1.0	3	METS Assumption
Water Requirement for Cathode Cleaning	m <sup>3</sup> /clean	15.0	18.0	3	METS Assumption
Electrowinning Efficiency	%	100		3	METS Assumption
<b>Copper Sulphate Crystalliser Package (400-PK-01)</b>					
Number of Units	#	1	1.0	3	METS Assumption
Type			Evaporative	3	METS Assumption



**Client** Deep-South Resources  
**Project** Haib Copper Project  
**Job #** J5329  
**Doc #** J5329-P-PDC-000-001  
**Doc Title** Process Design Criteria 8.5 Mtpa @ 85% Cu Recovery+CuSO4  
**Rev** A

**J5329 - Deep-South - Haib Copper Project - Process Design Criteria**

Description	Units	Nominal	Design	Ref	Comments
<b>Feed Rate</b>	m <sup>3</sup> /h	58.1	68.8	2	METS Calculated Value
<b>Residence Time</b>	h	1	1.0	3	METS Assumption
<b>Temperature</b>	°C	TBD	TBD		
<b>Crystallisation Rate</b>	t/h	TBD	TBD		
<b>Slurry Discharge Rate</b>	t/h	15.9	19.0	2	METS Calculated Value
<b>Solids %</b>	%	40%	40%	3	METS Assumption
<b>Crystallisation Efficiency</b>	%	100%	100%	3	METS Assumption
<b>Centrifuge</b>					
<b>Type</b>		Screen Scroll Centrifuge		3	METS Assumption
<b>Capacity</b>		TBD	TBD		
<b>Feed Rate</b>	t/h	16	19.0	2	METS Calculated Value
<b>Feed Solids %</b>	%	40%	40%	3	METS Assumption
<b>Discharge Rate</b>	t/h	6.9	8.3	2	METS Calculated Value
<b>Discharge Solids %</b>	%	92%	92%	3	METS Assumption
<b>Flash Dryer</b>					
<b>Type</b>		Flash Dryer			
<b>Feed Rate</b>	t/h	6.9	8.3	2	METS Calculated Value
<b>Residence Time</b>	h	TBD	TBD		
<b>Temperature</b>	°C	TBD	TBD		
<b>Product Discharge Rate</b>	t/h	6.3	7.6	2	METS Calculated Value
<b>Product Solids %</b>	%	99%	98%	3	METS Assumption

**J5329 - Deep-South - Haib Copper Project - Process Design Criteria**

Description	Units	Nominal	Design	Ref	Comments
<b>Area 500- Iron Precipitation</b>					
<b>Iron Precipitation Tank (500-TK-01)</b>					
Number of Tanks	#	1.0		3	METS Assumption
pH		5.8		3	METS Assumption
Temperature	°C	40		3	METS Assumption
Feed Rate	t/h	656		2	METS Calculated Value
Lime Addition Rate	dt/h	0.8	0.9	2	METS Calculated Value
Lime Density	t/m <sup>3</sup>	1.2	1.2	3	METS Assumption
Limestone Addition Rate	dt/h	1.4	1.7	2	METS Calculated Value
Residence Time	h	0.2	0.2	2	METS Calculated Value
Discharge Rate	t/h	659	659.0	2	METS Calculated Value
Capacity	m <sup>3</sup>	110	132	3	METS Assumption
<b>Iron Precipitate Thickener (500-TH-01)</b>					
Type of Thickener	-		High Rate	3	METS Assumption
No. of Thickeners	#	1	1.00	3	METS Assumption
Feed Rate (Solids)	dt/h	65	78.30	2	METS Calculated Value
Feed Rate (Slurry)	m <sup>3</sup> /h	606	726.65	2	METS Calculated Value
Feed % Solids	w/w %	10.1	10.1	2	METS Calculated Value
Underflow % Solids	w/w %	50	50	3	METS Assumption
Underflow Solid Rate	dt/h	65	78.30	2	METS Calculated Value
Underflow Liquid	t/h	65	78.30	2	METS Calculated Value
Underflow Slurry Rate	t/h	130	156.60	2	METS Calculated Value
Underflow Slurry Rate	m <sup>3</sup> /h	89	106.26	2	METS Calculated Value
Underflow Density	t/m <sup>3</sup>	1.47	1.47	2	METS Calculated Value
Overflow % Solids	w/w %	0.00	0.00	3	METS Assumption
Overflow Solid Rate	dt/h	0.00	0.00	2	METS Calculated Value
Overflow Liquid	t/h	529	634.20	3	METS Assumption
Overflow Slurry Rate	t/h	529	634.20	2	METS Calculated Value
Overflow Slurry Rate	m <sup>3</sup> /h	529	634.20	2	METS Calculated Value
Overflow Density	t/m <sup>3</sup>	1.00	1.00	3	METS Assumption
Flocculant Dosage	g/t	100	100	3	METS Assumption
Floc Rate	kg/h	6.52	7.83	2	METS Calculated Value
Settling Rate	m <sup>2</sup> /d	6.00	6.00	3	METS Assumption
Thickener Cross Sectional Area (Minimum)	m <sup>2</sup>	391	469.79	2	METS Calculated Value
Thickener Diameter (Minimum)	m	22	26.79	2	METS Calculated Value
Upflow Rate	m/h	1.35	1.62	2	METS Calculated Value
Residence Time	h	TBD	TBD		
Thickener Volume	m <sup>3</sup>	TBD	TBD		
<b>Iron Tailings Filter Feed Tank (500-TK-02)</b>					
Residence Time	min	30	30	3	METS Assumption
Slurry Flow	m <sup>3</sup> /h	89	106	2	METS Calculated Value
Volume	m <sup>3</sup>	45	54	2	METS Calculated Value
<b>Iron Tailings Filter Press (500-FL-01/02)</b>					
Type	-		Pressure	3	METS Assumption
Number of Filter Units	#	2.00	2.00	3	METS Assumption
Feed Rate (per Unit)	dt/h	32.6	39.15	2	METS Calculated Value
% Solids					
Feed	w/w %	50	50	3	METS Assumption
Cake	w/w %	10	10	3	METS Assumption
Filtration Rate	kg/m <sup>2</sup> /h	80	80	3	METS Assumption
Filter Area (per Unit)	m <sup>2</sup>	204	244.7	2	METS Calculated Value
Filter Cake Discharge	wet t/h	76.8	92.12	2	METS Calculated Value
Solids Discharge	dt/h	65.2	78.30	2	METS Calculated Value
Cake Moisture	t/h	11.51	13.82	2	METS Calculated Value
<b>Raffinate Recycle Tank (500-TK-03)</b>					
Residence Time	minutes	5	5	3	METS Assumption
Flow from Filtrate	m <sup>3</sup> /h	77	92	2	METS Calculated Value
Flow From Thickener	m <sup>3</sup> /h	529	634	2	METS Calculated Value
Flow rate (Total)	m <sup>3</sup> /h	605	726	2	METS Calculated Value
Volume	m <sup>3</sup>	51	61	2	METS Calculated Value
<b>Area 600 - Process and Raw Water</b>					
<b>Raw Water Dam (600-DM-01/02)</b>					
Raw Water Requirement	m <sup>3</sup> /h	140	168	2	METS Calculated Value
Raw Water Requirement	m <sup>3</sup> /d	3,354	4,025	2	METS Calculated Value
Residence Time	d	5	5	3	METS Assumption
Storage Capacity	m <sup>3</sup>	16,800	20,160	2	METS Calculated Value
<b>Raw Water Tank (600-TK-02)</b>					
Raw Water Requirement	m <sup>3</sup> /h	140	168	2	METS Calculated Value
Raw Water Requirement	m <sup>3</sup> /d	3354	4,025	2	METS Calculated Value
Residence Time	d	1	1	3	METS Assumption
Storage Capacity	m <sup>3</sup>	3400	4,080	2	METS Calculated Value
<b>Process Water Tank (600-TK-01/03)</b>					
Process Water Drawdown	m <sup>3</sup> /h	60	72	3	METS Assumption
Raw Water Requirement	m <sup>3</sup> /h	15	18	3	METS Assumption
Residence Time	d	1	1	3	METS Assumption
Storage Capacity	m <sup>3</sup>	1500	1,800	2	METS Calculated Value
<b>Raw Water</b>					

**J5329 - Deep-South - Haib Copper Project - Process Design Criteria**

Description	Units	Nominal	Design	Ref	Comments
<b>Supply Source</b>		Orange River			
<b>Analysis</b>					
pH		TBD			
E Coil		TBD			
Copper	ppm	TBD			
Iron	ppm	TBD			
Cobalt	ppm	TBD			
Nickel	ppm	TBD			
TSS	ppm	TBD			
TDS	ppm	TBD			
Total Sulphate	ppm	TBD			
<b>Potable Water Quality</b>					
pH	-	6.5-8	8.00		
Conductivity	µS/cm	TBD	5.80		
Total Dissolved Solids	mg/l	TBD	500		
Total Hardness as CaCO <sub>3</sub>	mg/l	TBD	200		
Na <sup>+</sup>	mg/l	TBD	180		
Cl <sup>-</sup>	mg/l	TBD	250		
Cl <sub>2</sub>	mg/l	TBD	5.00		
SO <sub>4</sub>	mg/l	TBD	250		
<b>Area 700- Reagents</b>					
<b>LIX-984N</b>					
Supply Method	-	Bulk		3	METS Assumption
Supply Form	-	Liquid		3	METS Assumption
Supply Bulk Density	t/m <sup>3</sup>	0.88		4	Market Specification
Storage Tank Residence Time	h	48	48.00	3	METS Assumption
Storage Tank Capacity	m <sup>3</sup>	2.00	2.40	2	METS Calculated Value
Mixing Tank Capacity	m <sup>3</sup>	1.00	1.20	2	METS Calculated Value
Mixing Tank Residence Time	h	5	5.00	3	METS Assumption
O in Solvent	%w/w	15	15.00	3	METS Assumption
Addition	m <sup>3</sup> /h	0.03	0.03	2	METS Calculated Value
Raw Diluent for Mixing	m <sup>3</sup> /h	0.17	0.17	2	METS Calculated Value
<b>Kerosene</b>					
Supply Method	-	Bulk		3	METS Assumption
Supply Form	-	Liquid		3	METS Assumption
Supply Bulk Density	t/m <sup>3</sup>	0.81		3	METS Assumption
Kerosene Process Feed	m <sup>3</sup> /h	0.17	0.20	2	METS Calculated Value
Storage Residence Time	h	24	24	3	METS Assumption
Storage Tank Capacity	m <sup>3</sup>	5.00	6.00	2	METS Calculated Value
<b>Quicklime</b>					
Supply Method	-	Bulk		3	METS Assumption
Supply Form	-	Solid		3	METS Assumption
Supply Density	t/m <sup>3</sup>	3.35		7	Other Sources
Supply Bulk Density	t/m <sup>3</sup>	0.88		7	Other Sources
Storage Residence Time	h	24		3	METS Assumption
Process Lime Requirement	t/h	0.79	0.93	2	METS Calculated Value
Raw Water for Mixing	m <sup>3</sup> /h	2.33	2.80	2	METS Calculated Value
Storage Silo Volume	m <sup>3</sup>	22.0	26.40	2	METS Calculated Value
Distribution Tank Residence Time	h	1	1	3	METS Assumption
Distribution Tank Volume	m <sup>3</sup>	3.00	3.60	2	METS Calculated Value
% Solids	%w/w	25%	25%	3	METS Assumption
<b>Limestone/Calcrete</b>					
Supply Method	-	Bulk		3	METS Assumption
Supply Form	-	Solid		3	METS Assumption
Supply Density	t/m <sup>3</sup>	2.60		7	Other Sources
Storage Residence Time	h	24		3	METS Assumption
Process Lime Requirement	t/h	3.45	4.14	2	METS Calculated Value
Raw Water for Mixing	m <sup>3</sup> /h	10.34	12.41	2	METS Calculated Value
Storage Silo Volume	m <sup>3</sup>	32.0	38.40	2	METS Calculated Value
Distribution Tank Residence Time	h	1	1	3	METS Assumption
Distribution Tank Volume	m <sup>3</sup>	12.00	14.40	2	METS Calculated Value
% Solids	%w/w	25%	25%	3	METS Assumption
<b>Sulphuric Acid</b>					
Supply Method	-	Bulk Tanker		3	METS Assumption
Supply Form	-	Liquid		3	METS Assumption
H <sub>2</sub> SO <sub>4</sub> Density	t/m <sup>3</sup>	1.84		3	METS Assumption
H <sub>2</sub> SO <sub>4</sub> Process Requirement	t/h	3.46		2	METS Calculated Value
H <sub>2</sub> SO <sub>4</sub> Process Requirement	m <sup>3</sup> /h	1.88	2.26	2	METS Calculated Value
H <sub>2</sub> SO <sub>4</sub> Storage Residence Time	h	24	24	3	METS Assumption
H <sub>2</sub> SO <sub>4</sub> Storage Tank Capacity	m <sup>3</sup>	46	55.20	2	METS Calculated Value
<b>Binder</b>					
Supply Method	-	Bulk Bag		3	METS Assumption
Supply Form	-	Solid		3	METS Assumption
Supply Bulk Density	t/m <sup>3</sup>	2.00		3	METS Assumption
Storage Residence Time	h	12		3	METS Assumption
Binder Consumption	kg/t	0.50		3	METS Assumption
Process Requirement	t/h	0.2	0.19	2	METS Calculated Value
Binder Feed Hopper Capacity	m <sup>3</sup>	1.0	1.20	2	METS Calculated Value
<b>Flocculant</b>					





Client Deep-South Resources  
 Project Haib Copper Project  
 Job # J5329  
 Doc # J5329-P-PDC-000-001  
 Doc Title Process Design Criteria 8.5 Mtpa @ 85% Cu Recovery+CuSO4  
 Rev A

**J5329 - Deep-South - Haib Copper Project - Process Design Criteria**

Description	Units	Nominal	Design	Ref	Comments
Type	-	Magnifloc 155	-	3	METS Assumption
Supply Method	-	25 kg Bags	-	3	METS Assumption
Supply Form	-	Solid	-	3	METS Assumption
Flocculant Mixing Tank Residence Time	h	2	-	3	METS Assumption
Flocculant Storage Tank Residence Time	h	24	-	3	METS Assumption
Flocculant Mixing Tank Capacity	L	10	-	2	METS Calculated Value
Flocculant Storage Tank Capacity	m <sup>3</sup>	1	-	2	METS Calculated Value
Bulk Density	kg/m <sup>3</sup>	0.75	-	7	Other Sources
Total Addition Rate	kg/h	6.81	8.17	3	METS Assumption
Addition Concentration	%w/v	25	25	3	METS Assumption
Inline Mixer Dilution	%w/v	2.5	2.5	3	METS Assumption
Viscosity (After dilution)	cP	300	300	3	METS Assumption
Addition Concentration (Belt Filter)	%w/v	25	25	3	METS Assumption
Raw Water for Mixing	m <sup>3</sup> /h	0.0004	0.0004	2	METS Calculated Value
<b>Area 800- Services</b>					
<b>Air Compressor</b>					
HP Air Compressor Type	-	Screw	-	3	METS Assumption
HP Air Pressure	kPa	750	-	3	METS Assumption
HP Air Compressor Capacity	Nm <sup>3</sup> /h	250	300	3	METS Assumption
<b>Plant Air Filter</b>					
Type	-	-	-	-	-
<b>Plant Air Receiver</b>					
Type	-	Standard Receiver Vessel	-	3	METS Assumption
HP Air Receiver Volume	L	-	-	3	METS Assumption
<b>Instrument Air</b>					
Instrument Air Pressure	kPa	750	-	3	METS Assumption
HP Air Compressor Capacity	m <sup>3</sup> /h	-	-	-	-

**J5329 - Deep-South - Haib Copper Project - Process Design Criteria**

	Description	Units	Nominal	Design	Ref	Comments
<b>Site Characteristics</b>						
<b>Haib Copper Project</b>						
	Latitude	-	28°41'-29 S			
	Longitude	-	17°51'18 E			
	Elevation	masl	157		1	Noordoever (closest town)
	Mean Annual Rainfall	mm/a	25-50		1	
	Highest 24 Hour Rainfall Event	mm	47.0		1	
	Winter Dry Bulb Temperature	°C	15.8		1	
	Winter Wet Bulb Temperature	°C	8.6		1	Tempeture at Windhoek
	Summer Dry Bulb Temperature	°C	40.0		1	Namibia desert Max temp
	Summer Wet Bulb Temperature	°C	35.0		1	
	Summer Daily Range Temperature	°C	20.00		1	
	Maximum Wind Velocity	km/h	15.8		1	Source: Namibia Weather 2019
<b>Operating Criteria</b>						
<b>Haib Copper Project</b>						
	Resource	Mt	456.9	456.9	1	Client Supplied Data
	Estimated Project Life	yr	23	19	3	METS Assumption
	Days per Year	Days	365	365	7	Other Sources
	Hours per Day	h	24	24	7	Other Sources
	Crusher Availability	%	70%	70%	3	METS Assumption
	Plant Availability	%	90%	90%	3	METS Assumption
	Heap Leach Availability	%	98%	98%	3	METS Assumption
	Plant Utilisation	%	90%	90%	3	METS Assumption
	Feed Moisture	%	3%	3%	3	METS Assumption
	Plant Throughput	t/a	20,000,000	24,000,000	3	METS Assumption
	Plant Throughput	t/h	2,537	3,044	2	METS Calculated Value
	Crusher Throughput	t/h	3,262	3,914	2	METS Calculated Value
	Crusher Operating Hours per Annum	h	6,132	6,132	3	METS Assumption
	Plant Operating Hours per Annum	h	7884	7884	1	Client Supplied Data
	Average Copper Head Grade	%	0.310	0.310	1	Client Supplied Data
	Overall Copper Recovery	%	80	0	2	METS Calculated Value
	Copper Recovered per Annum	t/yr	48073	tpa	3	METS Assumption
<b>Comminution Characteristics</b>						
	Abrasion Index (AI)	-	0.49	0.49	1	Client Supplied Data
	Ore Density	t/m <sup>3</sup>	2.8	2.8	1	Client Supplied Data
	Ore Bulk Density	t/m <sup>3</sup>	1.8	1.8	1	Client Supplied Data
	Crushing Work Index (CWi)	kWh/t	22.3	22.3	1	Client Supplied Data
	Bond Ball Mill Work Index (BWi)	kWh/t	18.0	18.0	1	Client Supplied Data
	Bond Rod Mill Work Index (RWI)	kWh/t	21.6	21.6	1	Client Supplied Data
	Angle of Repose	degrees	36	36	1	Client Supplied Data
	Angle of Reclaim	degrees	55	55	1	Client Supplied Data
<b>Area 100- Primary and Secondary Crushing</b>						
<b>Crushing Design Basis</b>						
	Throughput Operating	t/h	3,262	3,914	2	METS Calculated Value
<b>Plant Feed Size</b>						
	ROM Feed Size	F <sub>100</sub> mm	800	800	3	METS Assumption
<b>Crushing Product Size</b>						
	Screen Undersize	P <sub>20</sub> mm	5.7	5.3	3	METS Assumption
<b>ROM Bin (100-BN-01)</b>						
	Residence Time	h	0.25	0.25	3	METS Assumption
	Capacity	t	815	978	2	METS Calculated Value
	Volume	m <sup>3</sup>	291	349	2	METS Calculated Value
<b>Gyratory Crusher (100-CR-01)</b>						
	Configuration			Open Circuit		
	Type			Sandvik CG830i		
	Number of Units		1	1	3	METS Assumption
	Feed Rate	t/h	3,262	3,914	2	METS Calculated Value
	Feed Size	F <sub>80</sub> mm	495	495	2	METS Calculated Value
	Product Size	P <sub>80</sub> mm	150	150	2	METS Calculated Value
	Closed Setting	mm	177	177	2	METS Calculated Value
	Stroke	mm	38	38	2	METS Calculated Value
	Crusher Power Rating	kW	1,100	1,100	6	Vendor Supplied Data
<b>Gyratory Crusher Discharge Conveyor (100-CV-01)</b>						
	Feed Rate	t/h	3,262	3,914	2	METS Calculated Value
<b>Cone Crusher Feed Bins (100-BN-02/03/04/05/06)</b>						
	Combined Throughput	t/h	4,807	6,408	2	METS Calculated Value
	Units	-	5	5	3	METS Assumption
	Residence Time	h	0.50	0.50	3	METS Assumption
	Capacity per Bin	t	481	641	2	METS Calculated Value
	Volume per Bin	m <sup>3</sup>	267	356	2	METS Calculated Value
<b>Cone Crushers (100-CR-02/03/04/05/06)</b>						
	Type			Sandvik CH870i:03		
	No. of Units	#	5	5	3	METS Assumption
	Cavity Type	-	Standard Fine	Standard Medium		
	Feed Rate	Per Unit t/h	961	1282	2	METS Calculated Value

**J5329 - Deep-South - Haib Copper Project - Process Design Criteria**

Description	Units	Nominal	Design	Ref	Comments
Feed Size	F <sub>80</sub> mm	132	126	2	METS Calculated Value
Product Size	P <sub>80</sub> mm	31	40	2	METS Calculated Value
Closed Size Setting	mm	25	25	3	METS Assumption
Power Rating	Per Unit kW	746	746	6	Vendor Supplied Data
<b>Cone Crusher Screen (100-SC-01/02/03)</b>					
Type		Metso TS5.2 Double-Deck Banana			
Feed Rate	t/h	4,807	6,408	2	METS Calculated Value
Screen Area	m <sup>2</sup>	60	60	6	Vendor Supplied Data
No. of Units	#	3	3	3	METS Assumption
Product Size	P <sub>80</sub> mm	20.7	27.8	2	METS Calculated Value
Screen Flow Rates	O/S t/h	1,545	2,494	2	METS Calculated Value
	U/S t/h	3,262	3,914	2	METS Calculated Value
Deck 1 Screen Aperture	mm	50	45	3	METS Assumption
Deck 2 Screen Aperture	mm	30	35	3	METS Assumption
<b>Crushed Ore Stockpile</b>					
Ore Delivery		Conveyor			
Feed Rate	t/h	3,262	3,914	2	METS Calculated Value
Number of Reclaim Chutes	#	2	2	3	METS Assumption
Live Stockpile Residence Time	h	12	12	3	METS Assumption
Live Stockpile Capacity	t	39,139	46,967	2	METS Calculated Value
Live Stockpile Volume	m <sup>3</sup>	21,744	26,093	2	METS Calculated Value
Total Stockpile Volume	m <sup>3</sup>	86,975	104,371	3	METS Assumption
Stockpile Diameter	m	49	52	2	METS Calculated Value
<b>Crushing plant to the Processing Plant Conveyor (100-CV-07)</b>					
Feed Rate	t/h	3,262	3,914	2	METS Calculated Value
Length	m	TBD	TBD		

**Area 200- Tertiary Crushing**

<b>HPGR Feed Stockpile</b>					
Ore Delivery		Conveyor			
Feed Rate	t/h	3,262	3,914	2	METS Calculated Value
Discharge Chutes	#	2	2	3	METS Assumption
Discharge Rate	t/h	2,537	3,044	2	METS Calculated Value
Live Stockpile Residence Time	h	48	48	3	METS Assumption
Live Stockpile Capacity	t	121,766	146,119	2	METS Calculated Value
Live Stockpile Volume	m <sup>3</sup>	67,648	81,177	2	METS Calculated Value
Total Stockpile Volume	m <sup>3</sup>	270,590	324,708	3	METS Assumption
Stockpile Diameter	m	71	75	2	METS Calculated Value
<b>HPGR Design Basis</b>					
Availability	%	90.00	90.00	3	METS Assumption
Throughput	t/h	2,537	3,044	2	METS Calculated Value
Fresh Feed Size	mm	20.65	27.80	2	METS Calculated Value
<b>HPGR Feed Bin (200-BN-01/02)</b>					
Fresh Feed	t/h	2,537	3,044	2	METS Calculated Value
No. of Units	#	2	2	3	METS Assumption
Recycle to Fresh Feed Ratio	%	30	30	3	METS Assumption
Recycle Rate	t/h	761	913	2	METS Calculated Value
Feed Rate Total	t/h	3,298	3,957	2	METS Calculated Value
Residence Time	h	0.50	0.50	3	METS Assumption
Capacity per Bin	t	824	989	2	METS Calculated Value
Volume per Bin	m <sup>3</sup>	458	550	2	METS Calculated Value
<b>HPGR (200-GR-01/02)</b>					
Vendor		Koppers			
Type		900-22.8-ONH 1600 PG1E			
Number	#	2.00	2.00		
Roll Speed	m/s	2.00	2.00	6	Vendor Supplied Data
Roll Length	mm	1500	1500	6	Vendor Supplied Data
Roll Diameter	mm	2000	2000	6	Vendor Supplied Data
Feed Rate (per Unit)	t/h	1,649	1,979	2	METS Calculated Value
Feed Size	F <sub>80</sub> mm	19.30	22.80	3	METS Assumption
Product Size	P <sub>80</sub> mm	8.70	9.50	3	METS Assumption
Power Rating	kW	3800	3800	3	METS Assumption
<b>HPGR Screen (200-SC-02)</b>					
Type		Metso TS5.2 Double-Deck Banana		3	METS Assumption
Feed Rate	t/h	3,298	3,957	2	METS Calculated Value
Screen Area	m <sup>2</sup>	80	80	6	Vendor Supplied Data
No of Units	#	4	4	3	METS Assumption
Product Size , P80	mm	5.7	5.3	3	METS Assumption
Screen Flow Rates	O/S t/h	761	913	2	METS Calculated Value
	U/S t/h	2,537	3,044	2	METS Calculated Value
Screen Aperture	Top mm	16	16	3	METS Assumption
	Middle mm	11	11	3	METS Assumption
% Reporting to U/S	%	70	70	3	METS Assumption

**Area 300- Agglomeration and Heap Leaching**

<b>Leaching Design Basis</b>					
Feed Rate Solids	dt/h	2461	3044	2	METS Calculated Value
Feed Rate	t/h	2537	3044	2	METS Calculated Value

**J5329 - Deep-South - Haib Copper Project - Process Design Criteria**

Description	Units	Nominal	Design	Ref	Comments
Feed % Solids	w/w %	88.0	88.0	3	METS Assumption
Acid Consumption Rate	kg/t ore	10	12	3	METS Assumption
Barren Pond H <sub>2</sub> SO <sub>4</sub> Concentration	g/L	1.4	1.4	2	METS Calculated Value
Solution pH	-	0.0	0.0	2	METS Calculated Value
Total Acid Solution Rate	m <sup>3</sup> /h	3822	4587	2	METS Calculated Value
Binder Addition	kg/t	0.37	0.44	3	METS Assumption
Leach Extent Cu	%	85	85	5	Testwork Supplied Data
Leach Extent Al	%	20	20	5	Testwork Supplied Data
Leach Extent Fe	%	20	20	5	Testwork Supplied Data
Temperature	°C	40	40	3	METS Assumption
Total Residence Time	days	400	400	3	METS Assumption
Heap Evaporation Losses	%	2	2	3	METS Assumption
Pond Evaporation Losses	mm/day	8	8	3	METS Assumption
<b>Irrigation (300-IR-01-03)</b>					
Number of Leach Stages	#	3.00	3.00	3	METS Assumption
Irrigation Solution		Dilute Sulphuric Acid		3	METS Assumption
Irrigation Rate	L/h/m <sup>2</sup>	10.00	10.00	3	METS Assumption
Irrigation Type		Drippers		3	METS Assumption
Irrigation Solution Density	t/m <sup>3</sup>	1.00	1.00	3	METS Assumption
<b>Agglomerator Feed Bin (300-BN-01)</b>					
Residence Time	min	15	15	3	METS Assumption
Wet Solids Flow	m <sup>3</sup> /h	1,409	1,691	2	METS Calculated Value
Volume	m <sup>3</sup>	352	423	2	METS Calculated Value
<b>Agglomeration Drum (300-AD-01/02/03/04)</b>					
Model/Type	-	Rotary Drum		6	Vendor Supplied Data
No. of Units	#	4	4	3	METS Assumption
Feed Rate	dt/h	2,461	2,953	2	METS Calculated Value
Feed Rate	Wet t/h	2,537	3,044	2	METS Calculated Value
Water Addition	t/h	259.4	311.2	2	METS Calculated Value
Feed Rate	per unit t/h	699	839	2	METS Calculated Value
Total Mass Feed Rate	m <sup>3</sup> /h	1,668.7	2,002.4	2	METS Calculated Value
Percent Fill	%	20%	20%	3	METS Assumption
Void Volume	%	50%	50%	3	METS Assumption
Binder Addition	t/h	0.4	0.4	2	METS Calculated Value
Sulphuric Acid Addition	t/h	0.1	0.2	2	METS Calculated Value
Solids Content	%	88	88	3	METS Assumption
Residence Time	h	0.02	0.02	3	METS Assumption
Drum Minimum Volume	m <sup>3</sup>	166.9	200.2	2	METS Calculated Value
Drum Designed Volume	m <sup>3</sup>	333.7	400.5	2	METS Calculated Value
Solids Discharge Rate	dt/h	2,461	2,953	2	METS Calculated Value
Wet Solids Discharge Rate	t/h	2,797	3,356	2	METS Calculated Value
Wet Solids Bulk Density	t/m <sup>3</sup>	2.0	2.0	3	METS Assumption
<b>Primary Heap</b>					
Ore Delivery		Radial Stacker		3	METS Assumption
Feed Rate	t/h	2797	3356	2	METS Calculated Value
Irrigation Rate	L/h/m <sup>2</sup>	10.00	10.00	3	METS Assumption
Irrigation Solution	-	ILS		3	METS Assumption
Temperature	°C	40.00	40.00	3	METS Assumption
Irrigation Solution pH	-	TBD	TBD	3	METS Assumption
Heap Moisture	%	12	12	3	METS Assumption
Live Stockpile	days	120	120	3	METS Assumption
Live Stockpile Capacity	t	7,893,255	947,1906	2	METS Calculated Value
Leach Extent Cu	%	TBD	TBD		
Leach Extent Mo	%	TBD	TBD		
Leach Extent Al	%	TBD	TBD		
Leach Extent Fe	%	TBD	TBD		
Leachant Discharge Rate	m <sup>3</sup> /h	3,822	3,822	2	METS Calculated Value
Heap Lift Height	m	10.0	10.0	3	METS Assumption
Heap Width	m	120.00	144.00	2	METS Calculated Value
Heap Length	m	500.00	600.00	2	METS Calculated Value
Heap Height	m	40.00	48.00	2	METS Calculated Value
Heap Evaporation Loss	%	2	2	3	METS Assumption
<b>Secondary Heap</b>					
Irrigation Rate	L/h/m <sup>2</sup>	10.00	10.00	3	METS Assumption
Irrigation Solution	-	Barren		3	METS Assumption
Temperature	°C	40.00	40.00	3	METS Assumption
Irrigation Solution pH	-	TBD	TBD	3	METS Assumption
Heap Moisture	%	12	12	3	METS Assumption
Live Stockpile	days	120	120	3	METS Assumption
Live Stockpile Capacity	t	7,893,255	947,1906	2	METS Calculated Value
Leach Extent Cu	%	TBD	TBD		
Leach Extent Mo	%	TBD	TBD		
Leach Extent Al	%	TBD	TBD		
Leach Extent Fe	%	TBD	TBD		
Leachant Discharge Rate	m <sup>3</sup> /h	3,822	4,587	2	METS Calculated Value
Heap Lift Height	m	10.00	12.00	3	METS Assumption
Heap Width	m	120.00	144.00	2	METS Calculated Value
Heap Length	m	500.00	600.00	2	METS Calculated Value
Heap Height	m	40.00	48.00	2	METS Calculated Value

**J5329 - Deep-South - Haib Copper Project - Process Design Criteria**

Description	Units	Nominal	Design	Ref	Comments
Heap Evaporation Loss	%	2	2	3	METS Assumption
<b>Washing Heap</b>					
Irrigation Rate	L/h/m <sup>2</sup>	10.00	10.00	3	METS Assumption
Irrigation Solution	-	Barren		3	METS Assumption
Temperature	°C	40.00	40.00	5	Testwork Supplied Data
Irrigation Solution pH	-	2.54	2.54	3	METS Assumption
Heap Moisture	%	12	12	3	METS Assumption
Live Stockpile	days	160	160	2	METS Calculated Value
Live Stockpile Capacity	t	10,524,340	12629208	3	METS Assumption
Leach Extent Cu	%	TBD	TBD		
Leach Extent Mo	%	TBD	TBD		
Leach Extent Al	%	TBD	TBD		
Leach Extent Fe	%	TBD	TBD		
Leachant Discharge Rate	m <sup>3</sup> /h	5,096	6,116	2	METS Calculated Value
Heap Lift Height	m	10.00	12.00	3	METS Assumption
Heap Width	m	120.00	144.00	2	METS Calculated Value
Heap Length	m	500.00	600.00	2	METS Calculated Value
Heap Height	m	40.00	48.00	2	METS Calculated Value
Heap Evaporation Loss	%	2	2	3	METS Assumption
<b>Active Solution Pond (300-PD-03)</b>					
Volume/pad	m <sup>3</sup>	91,800	110,160	2	METS Calculated Value
Feed Rate (98% operating basis)	m <sup>3</sup> /h	5,096	6,116	2	METS Calculated Value
Solution pH	-	1.31	1.31	2	METS Calculated Value
Temperature	°C	40.00	40.00	3	METS Assumption
Loss From Evaporation	m <sup>3</sup> /h	6.12	7.34	2	METS Calculated Value
Discharge Rate (90% operating basis)	m <sup>3</sup> /h	3,865	4,638	2	METS Calculated Value
<b>ILS Pond (300-PD-02)</b>					
Volume/pad	m <sup>3</sup>	91,800	110,160	2	METS Calculated Value
Feed Rate	m <sup>3</sup> /h	5,096	6,116	2	METS Calculated Value
pH	-	TBD	TBD		
Temperature	°C	40	40	3	METS Assumption
Loss From Evaporation	m <sup>3</sup> /h	6.12	7.34	2	METS Calculated Value
Discharge Rate	m <sup>3</sup> /h	3,865	4,638	2	METS Calculated Value
<b>Barren Pond (300-PD-01)</b>					
Volume/pad	m <sup>3</sup>	91,800	110,160	2	METS Calculated Value
SX Return Feed Rate (90% operating basis)	m <sup>3</sup> /h	5,096	6,116	2	METS Calculated Value
Acid Addition (98% operating basis)	t/h	0.0	0.0	2	METS Calculated Value
Water Addition (98% operating basis)	t/h	0	0	2	METS Calculated Value
pH	-	1.29	1.29	2	METS Calculated Value
Temperature	°C	40	40	3	METS Assumption
Loss From Evaporation	m <sup>3</sup> /h	6.12	7.34	2	METS Calculated Value
Discharge Rate to Secondary Heap (98% operating basis)	m <sup>3</sup> /h	5,096	6,116	2	METS Calculated Value
<b>Piping and Materials</b>					
Pad Liner Material	-	1.5 mm HDPE with Thermal Welds		3	METS Assumption
Barren/ILS/PLS/Raffinate Return Piping	-	HDPE Piping		3	METS Assumption
<b>Area 400- Copper SX, Electrowinning and Crystallisation</b>					
<b>Circuit Configuration</b>					
Number of Trains	#	1.00	1.00	2	METS Calculated Value
Configuration	-	2E x 2 S	2E x 1SC x 1 S	2	METS Calculated Value
Contacting Units	ppm	mixer settlers, single distributor and 3 picket fences		3	METS Assumption
Availability	days	7,884	7,884	3	METS Assumption
<b>pH Adjustment Hopper (400-TK-01)</b>					
Feed	m <sup>3</sup> /h	3,865	4,638	2	METS Calculated Value
pH Feed	pH	1.31	1.57	2	METS Calculated Value
pH Discharge	pH	2	2	2	METS Calculated Value
Lime/Calcrete Added	t/h	3	3	2	METS Calculated Value
Residence Time	h	0.08	0.08	3	METS Assumption
Tank Capacity	m <sup>3</sup>	323	388	2	METS Calculated Value
<b>pH Adjustment Thickener (400-TH-01)</b>					
Type of Thickener	-	High Rate		3	METS Assumption
No. of Thickeners	#	3	1	3	METS Assumption
Feed Rate (Solids)	g/h	1	4,14	2	METS Calculated Value
Feed Rate (Slurry)	m <sup>3</sup> /h	3866	4,639	2	METS Calculated Value
Feed % Solids	w/w %	0.10	0.10	2	METS Calculated Value
Underflow % Solids	w/w %	50	50	3	METS Assumption
Underflow Solids Rate	dt/h	3	4.14	2	METS Calculated Value
Underflow Liquid	t/h	3	4.14	2	METS Calculated Value
Underflow Slurry Rate	t/h	7	8.28	2	METS Calculated Value
Underflow Slurry Rate	m <sup>3</sup> /h	5	5.62	2	METS Calculated Value
Underflow Density	t/m <sup>3</sup>	1.47	1.47	2	METS Calculated Value
Overflow % Solids	w/w %	0.00	0.00	3	METS Assumption
Overflow Solids Rate	dt/h	0.00	0.00	2	METS Calculated Value
Overflow Liquid	t/h	3861	4633	2	METS Calculated Value
Overflow Slurry Rate	t/h	3861	4633	2	METS Calculated Value
Overflow Slurry Rate	m <sup>3</sup> /h	3861	4633	2	METS Calculated Value
Overflow Density	t/m <sup>3</sup>	1.00	1.00	2	METS Calculated Value
Flocculant Dosage	g/t	100	100	3	METS Assumption

**J5329 - Deep-South - Haib Copper Project - Process Design Criteria**

Description	Units	Nominal	Design	Ref	Comments
Floc Rate	kg/h	0.34	0.41	2	METS Calculated Value
Settling Rate	m <sup>3</sup> /h/d	6.00	6.00	3	METS Assumption
Thickener Cross Sectional Area (Minimum)	m <sup>2</sup>	20.70	24.83	2	METS Calculated Value
Thickener Diameter (Minimum)	m	5	6.16	2	METS Calculated Value
Upflow Rate	m/h	186.57	223.89	2	METS Calculated Value
Residence time	h	TBD	TBD		
Thickener Volume	m <sup>3</sup>	TBD	TBD		
<b>pH Adjustment Filter Feed Tank (400-HP-01)</b>					
Residence Time	min	90	90	3	METS Assumption
Slurry Flow	m <sup>3</sup> /h	5	6	2	METS Calculated Value
Volume	m <sup>3</sup>	8	10	2	METS Calculated Value
<b>pH Adjustment Filter Press (400-FL-01/02)</b>					
Type	-	Pressure	Pressure	3	METS Assumption
Number of Filter Units	#	1	2	3	METS Assumption
Feed Rate (per Unit)	dt/h	3	4	2	METS Calculated Value
% Solids					
Feed	w/w %	50	50	3	METS Assumption
Cake	w/w %	5%	5%	3	METS Assumption
Filtration Rate	kg/m <sup>2</sup> /h	80	80	3	METS Assumption
Filter Area (per Unit)	m <sup>2</sup>	22	26	2	METS Calculated Value
Filter Cake Discharge (wet)	t/h	4	5	2	METS Calculated Value
Solids Discharge	dt/h	3	4	2	METS Calculated Value
Cake Moisture	t/h	1	1	2	METS Calculated Value
<b>SX Feed Polishing Filter (400-FL-03/04/05)</b>					
Type	-	Polishing	Polishing	3	METS Assumption
Number of Filter Units	#	4	4	3	METS Assumption
Feed Rate (per Unit)	m <sup>3</sup> /h	965	1,158	2	METS Calculated Value
Filter Area (per Unit)	m <sup>2</sup>	TBC	TBC		
Filter Cake Discharge (wet)	t/h	TBC	TBC		
Solids Discharge	dt/h	TBC	TBC		
Cake Moisture	t/h	TBC	TBC		
Filtrate	m <sup>3</sup> /h	3,861	4,633	2	METS Calculated Value
<b>SX PLS Feed Tank (400-TK-02)</b>					
Residence Time	min	10	10	3	METS Assumption
PLS Flowrate	m <sup>3</sup> /h	3,861	4,633	2	METS Calculated Value
Volume	m <sup>3</sup>	644	773	2	METS Calculated Value
<b>Copper Extraction Mixer Settler (400-SX-01/02)</b>					
Number of Cells	#	2	2	3	METS Assumption
Volume/Cell Minimum (Mixer)	m <sup>3</sup>	193	232	2	METS Calculated Value
Volume/Cell Minimum (Settler)	m <sup>3</sup>	1,030	1,236	2	METS Calculated Value
Residence Time (Mixer)	min	1.50	1.50	3	METS Assumption
Residence Time (Settler)	min	8.00	8.00	3	METS Assumption
Feed Rate	m <sup>3</sup> /h	3,861	4,633	2	METS Calculated Value
O/A Ratio		1:1	1:1	3	METS Assumption
Organic in Solvent	%	15	15	3	METS Assumption
Organic Feed Rate	m <sup>3</sup> /h	3,861	4,633	2	METS Calculated Value
LIX Loss Rate	m <sup>3</sup> /h	0.070	0.083	2	METS Calculated Value
Organic Makeup	m <sup>3</sup> /h	0.46	0.56	2	METS Calculated Value
Organic Diluent Loss Rate	m <sup>3</sup> /h	0.39	0.47	2	METS Calculated Value
Temperature	°C	Ambient	Ambient	3	METS Assumption
pH Initial		2.00	2.00	2	METS Calculated Value
Discharge Rate (Loaded Organic)	m <sup>3</sup> /h	3,861	4,633	2	METS Calculated Value
Organic Recovery	%	99.988%	99.988%	3	METS Assumption
Mixer Diameter		TBD	TBD		
Mixer Height		TBD	TBD		
Settler Width		TBD	TBD		
Settler Area Settler Length		TBD	TBD		
Copper Extraction	%	98%	98%	3	METS Assumption
Impurities Extraction	%	0%	0%	3	METS Assumption
<b>Loaded Organic Tank (400-TK-04)</b>					
Organic Feed	m <sup>3</sup> /h	3861	4633	2	METS Calculated Value
Residence Time	h	0.08	0.08	3	METS Assumption
Tank Capacity	m <sup>3</sup>	322	386	2	METS Calculated Value
<b>Copper Stripping Mixer Settler (400-SX-03/04)</b>					
Number of Cells	#	2	2	3	METS Assumption
Volume/Cell Minimum (Mixer)	m <sup>3</sup>	102	123	2	METS Calculated Value
Volume/Cell Minimum (Settler)	m <sup>3</sup>	545	654	2	METS Calculated Value
Residence Time (Mixer)	min	1.50	1.50	3	METS Assumption
Residence Time (Settler)	min	8.00	8.00	3	METS Assumption
Organic Feed Rate	m <sup>3</sup> /h	3,861	4,633	2	METS Calculated Value
O/A		16:1	16:1	3	METS Assumption
Stripping Solution Feed Rate	m <sup>3</sup> /h	227.3	272.8	3	METS Assumption
Temperature	°C	Ambient	Ambient	3	METS Assumption
Organic Discharge Rate	m <sup>3</sup> /h	3,861	4,633	2	METS Calculated Value
Aqueous Discharge Rate	m <sup>3</sup> /h	227.3	272.8	2	METS Calculated Value
H <sub>2</sub> SO <sub>4</sub> Concentration	g/L	200.00	200.00	3	METS Assumption
H <sub>2</sub> SO <sub>4</sub> (100%) Required	t/h	45.5	45.5	2	METS Calculated Value

**J5329 - Deep-South - Haib Copper Project - Process Design Criteria**

Description	Units	Nominal	Design	Ref	Comments
H <sub>2</sub> SO <sub>4</sub> (100%) Recycled	t/h	0.0	0.0	2	METS Calculated Value
H <sub>2</sub> SO <sub>4</sub> (100%) Makeup	t/h	4.6	5.6	2	METS Calculated Value
Temperature	°C	Ambient	Ambient	3	METS Assumption
pH		-0.61	-0.61	2	METS Calculated Value
Split to Electrowinning	%	100	100	3	METS Assumption
Stripping Efficiency	%	100	100	3	METS Assumption
<b>Organic Control Tank (400-TK-03)</b>					
Organic Feed	m <sup>3</sup> /h	3861	4633	2	METS Calculated Value
Residence Time	h	0.08	0.08	3	METS Assumption
Tank Capacity	m <sup>3</sup>	322	386	2	METS Calculated Value
<b>Stripping Liquor Makeup Tank (400-TK-05)</b>					
Feed	m <sup>3</sup> /h	227.3	272.8	2	METS Calculated Value
Residence Time	h	0.08	0.08	3	METS Assumption
Tank Capacity	m <sup>3</sup>	19	23	2	METS Calculated Value
<b>Copper Electrowinning Cells (400-EC-01---188)</b>					
Number of Cells	#	188	188	3	METS Assumption
Electrowin Time	days	TBD	1.00		
Cell Volume	m <sup>3</sup>	TBD	519.6		
Flowrate	m <sup>3</sup> /h	0.9	1.1	2	METS Calculated Value
Current Density	A/m <sup>2</sup>	282.0	282.0	3	METS Assumption
Cell Voltage	V	2.0	2.0	3	METS Assumption
Cathode Material	-	Stainless Steel Blank Cathodes		3	METS Assumption
Cathode Cleaning	-	High Pressure Water		3	METS Assumption
Cathode Cleaning Frequency	per week	1.0	1.0	3	METS Assumption
Water Requirement for Cathode Cleaning	m <sup>3</sup> /clean	15.0	18.0	3	METS Assumption
Electrowinning Efficiency	%	100		3	METS Assumption
<b>Copper Sulphate Crystalliser Package (400-PK-01)</b>					
Number of Units	#	1	1	3	METS Assumption
Type	-	Evaporative		3	METS Assumption
Feed Rate	m <sup>3</sup> /h	61.7	74.0	2	METS Calculated Value
Residence Time	h	1	1.0	3	METS Assumption
Temperature	°C	TBD	TBD		
Crystallisation Rate	t/h	TBD	TBD		
Slurry Discharge Rate	t/h	16	19.0	2	METS Calculated Value
Solids %	%	40%	40%	3	METS Assumption
Crystallisation Efficiency	%	100	100.0	3	METS Assumption
<b>Centrifuge</b>					
Type	-	Screen Scroll Centrifuge		3	METS Assumption
Capacity	-	TBD	TBD		
Feed Rate	t/h	15.9	19.0	2	METS Calculated Value
Feed Solids %	%	40%	40%	3	METS Assumption
Discharge Rate	t/h	6.9	8.3	2	METS Calculated Value
Discharge Solids %	%	92%	92%	3	METS Assumption
<b>Flash Drying Circuit Package (400-PK-02)</b>					
Type	-	Flash Dryer			
Feed Rate	t/h	6.9	8.3	2	METS Calculated Value
Residence Time	h	TBD	TBD		
Temperature	°C	TBD	TBD		
Product Discharge Rate	t/h	6.3	7.6	2	METS Calculated Value
Product Solids %	%	98%	98%	3	METS Assumption

**J5329 - Deep-South - Haib Copper Project - Process Design Criteria**

Description	Units	Nominal	Design	Ref	Comments
<b>Area 500 - Iron Precipitation</b>					
<b>Iron Precipitation Tank (500-TK-01)</b>					
Number of Tanks	#	1.0		3	METS Assumption
pH		5.8		3	METS Assumption
Temperature	°C	40		3	METS Assumption
Feed Rate	t/h	1,543		2	METS Calculated Value
Lime Addition Rate	dt/h	1.8	2.1	2	METS Calculated Value
Lime Density	t/m <sup>3</sup>	1.2	1.2	3	METS Assumption
Limestone/Calcrete	dt/h	3.1	3.8	2	METS Calculated Value
Residence Time	h	0.2	0.2	2	METS Calculated Value
Discharge Rate	t/h	1,550	1,550.5	2	METS Calculated Value
Capacity	m <sup>3</sup>	259	310.8	3	METS Assumption
<b>Iron Precipitate Thickener (500-TH-01)</b>					
Type of Thickener	-	High Rate		3	METS Assumption
No. of Thickeners	#	1	1.00	3	METS Assumption
Feed Rate (Solids)	dt/h	148	177.36	2	METS Calculated Value
Feed Rate (Slurry)	m <sup>3</sup> /h	1429	1,715.25	2	METS Calculated Value
Feed % Solids	w/w %	9.7	9.7	2	METS Calculated Value
Underflow % Solids	w/w %	50	50	3	METS Assumption
Underflow Solid Rate	dt/h	148	177.36	2	METS Calculated Value
Underflow Liquid	t/h	148	177.36	2	METS Calculated Value
Underflow Slurry Rate	t/h	296	354.72	2	METS Calculated Value
Underflow Slurry Rate	m <sup>3</sup> /h	201	240.70	2	METS Calculated Value
Underflow Density	t/m <sup>3</sup>	1.47	1.47	2	METS Calculated Value
Overflow % Solids	w/w %	0.00	0.00	3	METS Assumption
Overflow Solid Rate	dt/h	0.00	0.00	2	METS Calculated Value
Overflow Liquid	t/h	1,255	1,505.84	3	METS Assumption
Overflow Slurry Rate	t/h	1,255	1,505.84	2	METS Calculated Value
Overflow Slurry Rate	m <sup>3</sup> /h	1,255	1,505.84	2	METS Calculated Value
Overflow Density	t/m <sup>3</sup>	1.00	1.00	3	METS Assumption
Flocculant Dosage	g/t	100	100	3	METS Assumption
Floc Rate	kg/h	14.78	17.74	2	METS Calculated Value
Settling Rate	m <sup>2</sup> /t/d	6.00	6.00	3	METS Assumption
Thickener Cross Sectional Area (Minimum)	m <sup>2</sup>	887	1,064.17	2	METS Calculated Value
Thickener Diameter (Minimum)	m	34	40.32	2	METS Calculated Value
Upflow Rate	m/h	1.42	1.70	2	METS Calculated Value
Residence Time	h	TBD	TBD		
Thickener Volume	m <sup>3</sup>	TBD	TBD		
<b>Iron Tailings Filter Feed Tank (500-TK-02)</b>					
Residence Time	min	30	30	3	METS Assumption
Slurry Flow	m <sup>3</sup> /h	201	241	2	METS Calculated Value
Volume	m <sup>3</sup>	101	121	2	METS Calculated Value
<b>Iron Tailings Filter Press (500-FL-01/02)</b>					
Type	-	Pressure	TBD	3	METS Assumption
Number of Filter Units	#	2.00	2.00	3	METS Assumption
Feed Rate	(per Unit) dt/h	73.9	88.68	2	METS Calculated Value
% Solids					
Feed	w/w %	50	50	3	METS Assumption
Cake	w/w %	10	10	3	METS Assumption
Filtration Rate	kg/m <sup>2</sup> /h	80.00	80	3	METS Assumption
Filter Area	(per Unit) m <sup>2</sup>	462	554.3	2	METS Calculated Value
Filter Cake Discharge	wet t/h	173.9	208.7	2	METS Calculated Value
Solids Discharge	dt/h	147.8	177.4	2	METS Calculated Value
Cake Moisture	t/h	26.08	31.3	2	METS Calculated Value
<b>Raffinate Recycle Tank (500-TK-03)</b>					
Residence Time	minutes	5	5	3	METS Assumption
Flow from Filtrate	m <sup>3</sup> /h	174	209	2	METS Calculated Value
Flow From Thickener	m <sup>3</sup> /h	1,255	1,506	2	METS Calculated Value
Flow rate (Total)	m <sup>3</sup> /h	1,429	1,715	2	METS Calculated Value
Volume	m <sup>3</sup>	120	144	2	METS Calculated Value
<b>Area 600 - Process and Raw Water</b>					
<b>Raw Water Dam (600-DM-01/02)</b>					
Raw Water Requirement	m <sup>3</sup> /h	302	362	2	METS Calculated Value
Raw Water Requirement	m <sup>3</sup> /d	7,250	8,699	2	METS Calculated Value
Residence Time	d	5	5	3	METS Assumption
Storage Capacity	m <sup>3</sup>	36,300	43,560	2	METS Calculated Value
<b>Raw Water Tank (600-TK-02)</b>					
Raw Water Requirement	m <sup>3</sup> /h	302	362	2	METS Calculated Value
Raw Water Requirement	m <sup>3</sup> /d	7,250	8,699	2	METS Calculated Value
Residence Time	d	1	1	3	METS Assumption
Storage Capacity	m <sup>3</sup>	7,900	8,760	2	METS Calculated Value
<b>Process Water Tank (600-TK-01/03)</b>					
Process Water Drawdown	m <sup>3</sup> /h	60	72	3	METS Assumption
Raw Water Requirement	m <sup>3</sup> /h	15	18	3	METS Assumption
Residence Time	d	1	1	3	METS Assumption





**Client** Deep-South Resources  
**Project** Haib Copper Project  
**Job #** J5329  
**Doc #** J5329-P-PDC-000-001  
**Doc Title** Process Design Criteria 20 Mtpa @ 85% Cu Recovery+CuSO4  
**Rev** A

**J5329 - Deep-South - Haib Copper Project - Process Design Criteria**

Description	Units	Nominal	Design	Ref	Comments
Storage Capacity	m <sup>3</sup>	1500	1,800	2	METS Calculated Value
<b>Raw Water</b>					
Supply Source		Orange River			
<b>Analysis</b>					
pH		TBD			
E Coli		TBD			
Copper	ppm	TBD			
Iron	ppm	TBD			
Cobalt	ppm	TBD			
Nickel	ppm	TBD			
TSS	ppm	TBD			

**J5329 - Deep-South - Haib Copper Project - Process Design Criteria**

Description	Units	Nominal	Design	Ref	Comments
TDS	ppm	TBD			
Total Sulphate	ppm	TBD			
<b>Potable Water Quality</b>					
pH	-	6.5-8	8.00		
Conductivity	µS/cm	TBD	5.80		
Total Dissolved Solids	mg/l	TBD	500		
Total Hardness as CaCO <sub>3</sub>	mg/l	TBD	200		
Na <sup>+</sup>	mg/l	TBD	180		
Cl <sup>-</sup>	mg/l	TBD	250		
C <sub>6</sub>	mg/l	TBD	5.00		
SO <sub>4</sub>	mg/l	TBD	250		
<b>Area 700- Reagents</b>					
<b>LIX-984N</b>					
Supply Method	-	Bulk		3	METS Assumption
Supply Form	-	Liquid		3	METS Assumption
Supply Bulk Density	t/m <sup>3</sup>	0.88	-	4	Market Specification
Storage Tank Residence Time	h	48	48.00	3	METS Assumption
Storage Tank Capacity	m <sup>3</sup>	4.00	9.60	2	METS Calculated Value
Mixing Tank Capacity	m <sup>3</sup>	3.00	7.20	2	METS Calculated Value
Mixing Tank Residence Time	h	5	5.00	3	METS Assumption
O in Solvent	%w/w	15	15	3	METS Assumption
Addition	m <sup>3</sup> /h	0.07	0.07	2	METS Calculated Value
Raw Diluent for Mixing	m <sup>3</sup> /h	0.39	0.39	2	METS Calculated Value
<b>Kerosene</b>					
Supply Method	-	Bulk		3	METS Assumption
Supply Form	-	Liquid		3	METS Assumption
Supply Bulk Density	t/m <sup>3</sup>	0.81		3	METS Assumption
Kerosene Process Feed	m <sup>3</sup> /h	0.39	0.47	2	METS Calculated Value
Storage Residence Time	h	24	24	3	METS Assumption
Storage Tank Capacity	m <sup>3</sup>	10.00	12.00	2	METS Calculated Value
<b>Quicklime</b>					
Supply Method	-	Bulk		3	METS Assumption
Supply Form	-	Solid		3	METS Assumption
Supply Density	t/m <sup>3</sup>	3.35		7	Other Sources
Supply Bulk Density	t/m <sup>3</sup>	0.88		7	Other Sources
Storage Residence Time	h	24	-	3	METS Assumption
Process Lime Requirement	t/h	1.76	2.11	2	METS Calculated Value
Raw Water for Mixing	m <sup>3</sup> /h	5.28	6.34	2	METS Calculated Value
Storage Silo Volume	m <sup>3</sup>	48	58	2	METS Calculated Value
Distribution Tank Residence Time	h	1	1	3	METS Assumption
Distribution Tank Volume	m <sup>3</sup>	6.00	7.20	2	METS Calculated Value
% Solids	%w/w	25%	25%	3	METS Assumption
<b>Limestone/Cicrete</b>					
Supply Method	-	Bulk		3	METS Assumption
Supply Form	-	Solid		3	METS Assumption
Supply Density	t/m <sup>3</sup>	2.60	-	7	Other Sources
Storage Residence Time	h	24	-	3	METS Assumption
Process Requirement	t/h	5.58	6.82	2	METS Calculated Value
Raw Water for Mixing	m <sup>3</sup> /h	17.04	20.45	2	METS Calculated Value
Storage Silo Volume	m <sup>3</sup>	53	64	2	METS Calculated Value
Distribution Tank Residence Time	h	1	1	3	METS Assumption
Distribution Tank Volume	m <sup>3</sup>	20.00	24.00	2	METS Calculated Value
% Solids	%w/w	25%	25%	3	METS Assumption
<b>Sulphuric Acid</b>					
Supply Method	-	Bulk Bag		3	METS Assumption
Supply Form	-	S. Powder		3	METS Assumption
H <sub>2</sub> SO <sub>4</sub> Density	t/m <sup>3</sup>	1.84		3	METS Assumption
H <sub>2</sub> SO <sub>4</sub> Process Requirement	t/h	4.87		2	METS Calculated Value
H <sub>2</sub> SO <sub>4</sub> Process Requirement	m <sup>3</sup> /h	2.65	3.17	2	METS Calculated Value
H <sub>2</sub> SO <sub>4</sub> Storage Residence Time	h	24	24	3	METS Assumption
H <sub>2</sub> SO <sub>4</sub> Storage Tank Capacity	m <sup>3</sup>	64	76.80	2	METS Calculated Value
<b>Binder</b>					
Supply Method	-	Bulk Bag		3	METS Assumption
Supply Form	-	Solid		3	METS Assumption
Supply Bulk Density	t/m <sup>3</sup>	1.00		3	METS Assumption
Storage Residence Time	h	12		3	METS Assumption
Binder Consumption	kg/t	0.50	0.50	3	METS Assumption
Process Requirement	t/h	0.4	0.44	2	METS Calculated Value
Binder Feed Hopper Capacity	m <sup>3</sup>	5.0	6.00	2	METS Calculated Value
<b>Flocculant</b>					
Type	-	Magnaflow 155		3	METS Assumption
Supply Method	-	25 kg Bags		3	METS Assumption
Supply Form	-	Solid		3	METS Assumption
Flocculant Mixing Tank Residence Time	h	2		3	METS Assumption
Flocculant Storage Tank Residence Time	h	24		3	METS Assumption
Flocculant Mixing Tank Capacity	L	10		2	METS Calculated Value



**Client** Deep-South Resources  
**Project** Haib Copper Project  
**Job #** J5329  
**Doc #** J5329-P-PDC-000-001  
**Doc Title** Process Design Criteria 20 Mtpa @ 85% Cu Recovery+CuSO4  
**Rev** A

**J5329 - Deep-South - Haib Copper Project - Process Design Criteria**

Description	Units	Nominal	Design	Ref	Comments
Flocculant Storage Tank Capacity	m <sup>3</sup>	1		2	METS Calculated Value
Bulk Density	t/m <sup>3</sup>	0.75		7	Other Sources
Total Addition Rate	kg/h	15.13	18.15	3	METS Assumption
Addition Concentration	%w/v	25	25	3	METS Assumption
Inline Mixer Dilution	%w/v	2.5	2.5	3	METS Assumption
Viscosity (After dilution)	cP	300	300	3	METS Assumption
Addition Concentration (Belt Filter)	%w/v	25	25	3	METS Assumption
Raw Water for Mixing	m <sup>3</sup> /h	0.000807	0.000968	2	METS Calculated Value
<b>Area 800- Services</b>					
<b>Air Compressor</b>					
HP Air Compressor Type	-		Screw	3	METS Assumption
HP Air Pressure	kPa	750		3	METS Assumption
HP Air Compressor Capacity	Nm <sup>3</sup> /h	250	300	3	METS Assumption
<b>Plant Air Filter</b>					
Type					
<b>Plant Air Receiver</b>					
Type	-	Standard Receiver Vessel		3	METS Assumption
HP Air Receiver Volume	L			3	METS Assumption
<b>Instrument Air</b>					
Instrument Air Pressure	kPa	750		3	METS Assumption
HP Air Compressor Capacity	m <sup>3</sup> /h				

**J5329 - Deep-South - Haib Copper Project - Process Design Criteria**

Description	Units	Nominal	Design	Ref	Comments
<b>Site Characteristics</b>					
<b>Haib Copper Project</b>					
Latitude	-	28°41'29 S			
Longitude	-	17°51'18 E			
Elevation	masl	157		1	Noordoewer (closest town)
Mean Annual Rainfall	mm/a	25-50		1	
Highest 24 Hour Rainfall Event	mm	47.0		1	
Winter Dry Bulb Temperature	°C	15.8		1	
Winter Wet Bulb Temperature	°C	8.6		1	Tempeture at Windhoek
Summer Dry Bulb Temperature	°C	40.0		1	Namibia desert Max temp
Summer Wet Bulb Temperature	°C	35.0		1	
Summer Daily Range Temperature	°C	20.00		1	
Maximum Wind Velocity	km/h	15.8		1	Source: Namibia Weather 2019
<b>Operating Criteria</b>					
<b>Haib Copper Project</b>					
Resource	Mt	456.9	456.9	1	Client Supplied Data
Estimated Project Life	yr	23	19	3	METS Assumption
Days per Year	Days	365	365	7	Other Sources
Hours per Day	h	24	24	7	Other Sources
Crusher Availability	%	70%	70%	3	METS Assumption
Plant Availability	%	90%	90%	3	METS Assumption
Heap Leach Availability	%	98%	98%	3	METS Assumption
Plant Utilisation	%	90%	90%	3	METS Assumption
Feed Moisture	%	3%	3%	3	METS Assumption
Plant Throughput	t/a	20,000,000	24,000,000	3	METS Assumption
Plant Throughput	t/h	2,537	3,044	2	METS Calculated Value
Crusher Throughput	t/h	3,262	3,914	2	METS Calculated Value
Crusher Operating Hours per Annum	h	6,132	6,132	3	METS Assumption
Plant Operating Hours per Annum	h	7884	7884	1	Client Supplied Data
Average Copper Head Grade	%	0.310	0.310	1	Client Supplied Data
Overall Copper Recovery	%	0	0	2	METS Calculated Value
Copper Recovered per Annum	t/yr	0	0	3	METS Assumption
<b>Comminution Characteristics</b>					
Abrasion Index (Ai)	-	0.49	0.49	1	Client Supplied Data
Ore Density	t/m <sup>3</sup>	2.8	2.8	1	Client Supplied Data
Ore Bulk Density	t/m <sup>3</sup>	1.8	1.8	1	Client Supplied Data
Crushing Work Index (CWI)	kWh/t	22.3	22.3	1	Client Supplied Data
Bond Ball Mill Work Index (BWi)	kWh/t	18.0	18.0	1	Client Supplied Data
Bond Rod Mill Work Index (RWI)	kWh/t	21.6	21.6	1	Client Supplied Data
Angle of Repose	degrees	36	36	1	Client Supplied Data
Angle of Reclaim	degrees	55	55	1	Client Supplied Data
<b>Area 100- Primary and Secondary Crushing</b>					
<b>Crushing Design Basis</b>					
Throughput Operating	t/h	3,262	3,914	2	METS Calculated Value
<b>Plant Feed Size</b>					
ROM Feed Size	F <sub>100</sub> mm	800	800	3	METS Assumption
<b>Crushing Product Size</b>					
Screen Undersize	P <sub>80</sub> mm	5.7	5.3	3	METS Assumption
<b>ROM Bin (100-BN-01)</b>					
Residence Time	h	0.25	0.25	3	METS Assumption
Capacity	t	815	978	2	METS Calculated Value
Volume	m <sup>3</sup>	291	349	2	METS Calculated Value
<b>Gyratory Crusher (100-CR-01)</b>					
Configuration		Open Circuit			
Type		Sandvik CG830i			
Number of Units		1	1	3	METS Assumption
Feed Rate	t/h	3,262	3,914	2	METS Calculated Value
Feed Size	F <sub>80</sub> mm	495	495	2	METS Calculated Value
Product Size	P <sub>80</sub> mm	150	150	2	METS Calculated Value
Closed Setting	mm	177	177	2	METS Calculated Value
Stroke	mm	38	38	2	METS Calculated Value
Crusher Power Rating	kW	1,100	1,100	6	Vendor Supplied Data
<b>Gyratory Crusher Discharge Conveyor (100-CV-01)</b>					
Feed Rate	t/h	3,262	3,914	2	METS Calculated Value
<b>Cone Crusher Feed Bins (100-BN-02/03/04/05/06)</b>					
Combined Throughput	t/h	4,807	6,408	2	METS Calculated Value
Units	-	5	5	3	METS Assumption
Residence Time	h	0.50	0.50	3	METS Assumption
Capacity per Bin	t	481	641	2	METS Calculated Value
Volume per Bin	m <sup>3</sup>	267	356	2	METS Calculated Value
<b>Cone Crushers (100-CR-02/03/04/05/06)</b>					
Type		Sandvik CH870i:03			
No. of Units	#	5	5	3	METS Assumption
Cavity Type		Standard Fine	Standard Medium		
Feed Rate	Per Unit t/h	961	1282	2	METS Calculated Value
Feed Size	F <sub>80</sub> mm	132	126	2	METS Calculated Value
Product Size	P <sub>80</sub> mm	31	40	2	METS Calculated Value
Closed Size Setting	mm	25	25	3	METS Assumption
Power Rating	Per Unit kW	746	746	6	Vendor Supplied Data
<b>Cone Crusher Screen (100-SC-01/02/03)</b>					
Type		Metso TS5.2 Double-Deck Banana			
Feed Rate	t/h	4,807	6,408	2	METS Calculated Value
Screen Area	m <sup>2</sup>	60	60	6	Vendor Supplied Data
No. of Units	#	3	3	3	METS Assumption
Product Size	P <sub>80</sub> mm	20.7	27.8	2	METS Calculated Value
Screen Flow Rates	O/S t/h	1,545	2,494	2	METS Calculated Value

**J5329 - Deep-South - Haib Copper Project - Process Design Criteria**

Description	Units	Nominal	Design	Ref	Comments
Deck 1 Screen Aperture	U/S	3,262	3,914	2	METS Calculated Value
Deck 2 Screen Aperture	mm	50	45	3	METS Assumption
Deck 2 Screen Aperture	mm	30	35	3	METS Assumption
<b>Crushed Ore Stockpile</b>					
Ore Delivery		Conveyor			
Feed Rate	t/h	3,262	3,914	2	METS Calculated Value
Number of Reclaim Chutes	#	2	2	3	METS Assumption
Live Stockpile Residence Time	h	12	12	3	METS Assumption
Live Stockpile Capacity	t	39,139	46,967	2	METS Calculated Value
Live Stockpile Volume	m <sup>3</sup>	21,744	26,093	2	METS Calculated Value
Total Stockpile Volume	m <sup>3</sup>	86,975	104,371	3	METS Assumption
Stockpile Diameter	m	49	52	2	METS Calculated Value
<b>Crushing plant to the Processing Plant Conveyor (100-CV-07)</b>					
Feed Rate	t/h	3,262	3,914	2	METS Calculated Value
Length	m	TBD	TBD		

**Area 200- Tertiary Crushing**

<b>HPGR Feed Stockpile</b>						
Ore Delivery		Conveyor				
Feed Rate	t/h	3,262	3,914	2	METS Calculated Value	
Discharge Chutes	#	2	2	3	METS Assumption	
Discharge Rate	t/h	2,537	3,044	2	METS Calculated Value	
Live Stockpile Residence Time	h	48	48	3	METS Assumption	
Live Stockpile Capacity	t	121,766	146,119	2	METS Calculated Value	
Live Stockpile Volume	m <sup>3</sup>	67,648	81,177	2	METS Calculated Value	
Total Stockpile Volume	m <sup>3</sup>	270,590	324,708	3	METS Assumption	
Stockpile Diameter	m	71	75	2	METS Calculated Value	
<b>HPGR Design Basis</b>						
Availability	%	90.00	90.00	3	METS Assumption	
Throughput	t/h	2,537	3,044	2	METS Calculated Value	
Fresh Feed Size	mm	20.65	27.80	2	METS Calculated Value	
<b>HPGR Feed Bin (200-BN-01/02)</b>						
Fresh Feed	t/h	2,537	3,044	2	METS Calculated Value	
No. of Units	-	2	2	3	METS Assumption	
Recycle to Fresh Feed Ratio	%	30	30	3	METS Assumption	
Recycle Rate	t/h	761	913	2	METS Calculated Value	
Feed Rate Total	t/h	3,298	3,957	2	METS Calculated Value	
Residence Time	h	0.50	0.50	3	METS Assumption	
Capacity per Bin	t	824	989	2	METS Calculated Value	
Volume per Bin	m <sup>3</sup>	458	550	2	METS Calculated Value	
<b>HPGR (200-GR-01/02)</b>						
Vendor		Koppert				
Type		900-22.8-ONH 1600 PG1E				
Number	#	2.00	2.00			
Roll Speed	m/s	2.00	2.00	6	Vendor Supplied Data	
Roll Length	mm	1500	1500	6	Vendor Supplied Data	
Roll Diameter	mm	2000	2000	6	Vendor Supplied Data	
Feed Rate (per Unit)	t/h	1,649	1,979	2	METS Calculated Value	
Feed Size	F <sub>80</sub> mm	19.30	22.80	3	METS Assumption	
Product Size	P <sub>80</sub> mm	8.70	9.50	3	METS Assumption	
Power Rating	kW	3800	3800	3	METS Assumption	
<b>HPGR Screen (200-SC-02)</b>						
Type	-	Metso TS5.2 Double-Deck Banana			3	METS Assumption
Feed Rate	t/h	3,298	3,957	2	METS Calculated Value	
Screen Area	m <sup>2</sup>	80	80	6	Vendor Supplied Data	
No of Units	#	4	4	3	METS Assumption	
Product Size , P80	mm	5.7	5.3	3	METS Assumption	
Screen Flow Rates	O/S	t/h	761	913	2	METS Calculated Value
	U/S	t/h	2,537	3,044	2	METS Calculated Value
Screen Aperture	Top	mm	16	16	3	METS Assumption
	Middle	mm	11	11	3	METS Assumption
% Reporting to U/S	%	70	70	3	METS Assumption	

**Area 300- Agglomeration and Heap Leaching**

<b>Leaching Design Basis</b>					
Feed Rate Solids	dt/h	2461	3044	2	METS Calculated Value
Feed Rate	t/h	2537	3044	2	METS Calculated Value
Feed % Solids	w/w %	88.0	88.0	3	METS Assumption
Acid Consumption Rate	kg/t ore	10	12	3	METS Assumption
Barren Pond H <sub>2</sub> SO <sub>4</sub> Concentration	g/L	1.4	1.4	2	METS Calculated Value
Solution pH	-	0.0	0.0	2	METS Calculated Value
Total Acid Solution Rate	m <sup>3</sup> /h	3822	4587	2	METS Calculated Value
Binder Addition	kg/t	0.37	0.44	3	METS Assumption
Leach Extent Cu	%	85	85	5	Testwork Supplied Data
Leach Extent Al	%	20	20	5	Testwork Supplied Data
Leach Extent Fe	%	20	20	5	Testwork Supplied Data
Temperature	°C	40	40	3	METS Assumption
Total Residence Time	days	400	400	3	METS Assumption
Heap Evaporation Losses	%	2	2	3	METS Assumption
Pond Evaporation Losses	mm/day	8	8	3	METS Assumption
<b>Irrigation (300-IR-01-03)</b>					
Number of Leach Stages	#	3.00	3.00	3	METS Assumption
Irrigation Solution		Dilute Sulphuric Acid			
Irrigation Rate	L/h/m <sup>2</sup>	10.00	10.00	3	METS Assumption
Irrigation Type		Drippers			
Irrigation Solution Density	t/m <sup>3</sup>	1.00	1.00	3	METS Assumption
<b>Agglomerator Feed Bin (300-BN-01)</b>					
Residence Time	min	15	15	3	METS Assumption
Wet Solids Flow	m <sup>3</sup> /h	1,409	1,691	2	METS Calculated Value

**J5329 - Deep-South - Haib Copper Project - Process Design Criteria**

Description	Units	Nominal	Design	Ref	Comments
Volume	m <sup>3</sup>	352	423	2	METS Calculated Value
<b>Agglomeration Drum (300-AD-01/02/03/04)</b>					
Model/Type	-	Rotary Drum		6	Vendor Supplied Data
No. of Units	#	4	4	3	METS Assumption
Feed Rate	dt/h	2,461	2,953	2	METS Calculated Value
Feed Rate	Wet t/h	2,537	3,044	2	METS Calculated Value
Water Addition	t/h	259.4	311.2	2	METS Calculated Value
Feed Rate	per unit t/h	699	839	2	METS Calculated Value
Total Mass Feed Rate	m <sup>3</sup> /h	1,668.7	2,002.4	2	METS Calculated Value
Percent Fill	%	20%	20%	3	METS Assumption
Void Volume	%	50%	50%	3	METS Assumption
Binder Addition	t/h	0.4	0.4	2	METS Calculated Value
Sulphuric Acid Addition	t/h	0.1	0.2	2	METS Calculated Value
Solids Content	%	88	88	3	METS Assumption
Residence Time	h	0.02	0.02	3	METS Assumption
Drum Minimum Volume	m <sup>3</sup>	166.9	200.2	2	METS Calculated Value
Drum Designed Volume	m <sup>3</sup>	333.7	400.5	2	METS Calculated Value
Solids Discharge Rate	dt/h	2,461	2,953	2	METS Calculated Value
Wet Solids Discharge Rate	t/h	2,797	3,356	2	METS Calculated Value
Wet Solids Bulk Density	t/m <sup>3</sup>	2.0	2.0	3	METS Assumption
<b>Primary Heap</b>					
Ore Delivery	-	Radial Stacker		3	METS Assumption
Feed Rate	t/h	2797	3356	2	METS Calculated Value
Irrigation Rate	L/h/m <sup>2</sup>	10.00	10.00	3	METS Assumption
Irrigation Solution	-	ILS		3	METS Assumption
Temperature	°C	40.00	40.00	3	METS Assumption
Irrigation Solution pH		TBD	TBD	3	METS Assumption
Heap Moisture	%	12	12	3	METS Assumption
Live Stockpile	days	120	120	3	METS Assumption
Live Stockpile Capacity	t	7,893,255	9471906	2	METS Calculated Value
Leach Extent Cu	%	TBD	TBD		
Leach Extent Mo	%	TBD	TBD		
Leach Extent Al	%	TBD	TBD		
Leach Extent Fe	%	TBD	TBD		
Leachant Discharge Rate	m <sup>3</sup> /h	3,822	3,822	2	METS Calculated Value
Heap Lift Height	m	10.0	10.0	3	METS Assumption
Heap Width	m	120.00	144.00	2	METS Calculated Value
Heap Length	m	500.00	600.00	2	METS Calculated Value
Heap Height	m	40.00	48.00	2	METS Calculated Value
Heap Evaporation Loss	%	2	2	3	METS Assumption
<b>Secondary Heap</b>					
Irrigation Rate	L/h/m <sup>2</sup>	10.00	10.00	3	METS Assumption
Irrigation Solution	-	Barren		3	METS Assumption
Temperature	°C	40.00	40.00	3	METS Assumption
Irrigation Solution pH		TBD	TBD	3	METS Assumption
Heap Moisture	%	12	12	3	METS Assumption
Live Stockpile	days	120	120	3	METS Assumption
Live Stockpile Capacity	t	7,893,255	9471906	2	METS Calculated Value
Leach Extent Cu	%	TBD	TBD		
Leach Extent Mo	%	TBD	TBD		
Leach Extent Al	%	TBD	TBD		
Leach Extent Fe	%	TBD	TBD		
Leachant Discharge Rate	m <sup>3</sup> /h	3,822	4,587	2	METS Calculated Value
Heap Lift Height	m	10.00	12.00	3	METS Assumption
Heap Width	m	120.00	144.00	2	METS Calculated Value
Heap Length	m	500.00	600.00	2	METS Calculated Value
Heap Height	m	40.00	48.00	2	METS Calculated Value
Heap Evaporation Loss	%	2	2	3	METS Assumption
<b>Washing Heap</b>					
Irrigation Rate	L/h/m <sup>2</sup>	10.00	10.00	3	METS Assumption
Irrigation Solution	-	Barren		3	METS Assumption
Temperature	°C	40.00	40.00	5	Testwork Supplied Data
Irrigation Solution pH		4.85	4.85	3	METS Assumption
Heap Moisture	%	12	12	3	METS Assumption
Live Stockpile	days	160	160	2	METS Calculated Value
Live Stockpile Capacity	t	10,524,340	12629208	3	METS Assumption
Leach Extent Cu	%	TBD	TBD		
Leach Extent Mo	%	TBD	TBD		
Leach Extent Al	%	TBD	TBD		
Leach Extent Fe	%	TBD	TBD		
Leachant Discharge Rate	m <sup>3</sup> /h	5,096	6,116	2	METS Calculated Value
Heap Lift Height	m	10.00	12.00	3	METS Assumption
Heap Width	m	120.00	144.00	2	METS Calculated Value
Heap Length	m	500.00	600.00	2	METS Calculated Value
Heap Height	m	40.00	48.00	2	METS Calculated Value
Heap Evaporation Loss	%	2	2	3	METS Assumption
<b>Active Solution Pond (300-PD-03)</b>					
Volume/pad	m <sup>3</sup>	91,800	110,160	2	METS Calculated Value
Feed Rate (98% operating basis)	m <sup>3</sup> /h	5,096	6,116	2	METS Calculated Value
Solution pH		1.21	1.21	2	METS Calculated Value
Temperature	°C	40.00	40.00	3	METS Assumption
Loss From Evaporation	m <sup>3</sup> /h	6.12	7.34	2	METS Calculated Value
Discharge Rate (90% operating basis)	m <sup>3</sup> /h	3,865	4,638	2	METS Calculated Value
<b>ILS Pond (300-PD-02)</b>					
Volume/pad	m <sup>3</sup>	91,800	110,160	2	METS Calculated Value
Feed Rate	m <sup>3</sup> /h	5,096	6,116	2	METS Calculated Value
pH		TBD	TBD		
Temperature	°C	40	40	3	METS Assumption
Loss From Evaporation	m <sup>3</sup> /h	6.12	7.34	2	METS Calculated Value
Discharge Rate	m <sup>3</sup> /h	3,865	4,638	2	METS Calculated Value

**J5329 - Deep-South - Haib Copper Project - Process Design Criteria**

Description	Units	Nominal	Design	Ref	Comments	
<b>Barren Pond (300-PD-01)</b>						
Volume/pad	m <sup>3</sup>	91,800	110,160	2	METS Calculated Value	
SX Return Feed Rate (90% operating basis)	m <sup>3</sup> /h	5,096	6,116	2	METS Calculated Value	
Acid Addition (98% operating basis)	t/h	0.0	0.0	2	METS Calculated Value	
Water Addition (98% operating basis)	t/h	0	0	2	METS Calculated Value	
pH		1.27	1.27	2	METS Calculated Value	
Temperature	°C	40	40	3	METS Assumption	
Loss From Evaporation	m <sup>3</sup> /h	6.12	7.34	2	METS Calculated Value	
Discharge Rate to Secondary Heap (98% operating basis)	m <sup>3</sup> /h	5,096	6,116	2	METS Calculated Value	
<b>Piping and Materials</b>						
Pad Liner Material		1.5 mm HDPE with Thermal Welds		3	METS Assumption	
Barren/ILS /PLS /Raffinate Return Piping		HDPE Piping		3	METS Assumption	
<b>Area 400- Copper SX, Electrowinning and Crystallisation</b>						
<b>Circuit Configuration</b>						
Number of Trains	#	1.00	1.00	2	METS Calculated Value	
Configuration		2E x 2 S	2E x 1SC x 1 S	2	METS Calculated Value	
Contacting Units	ppm	ers, single distributor and 3 pi	single distributor and 3	3	METS Assumption	
Availability	days	7,884	7,884	3	METS Assumption	
<b>pH Adjustment Hopper (400-TK-01)</b>						
Feed	m <sup>3</sup> /h	3,865	4,638	2	METS Calculated Value	
pH Feed	pH	1.21	1.45	2	METS Calculated Value	
pH Discharge	pH	2	2	2	METS Calculated Value	
Lime/Calcrete Added	t/h	5	6	2	METS Calculated Value	
Residence Time	h	0.08	0.08	3	METS Assumption	
Tank Capacity	m <sup>3</sup>	323	388	2	METS Calculated Value	
<b>pH Adjustment Thickener (400-TH-01)</b>						
Type of Thickener	-	High Rate		3	METS Assumption	
No. of Thickeners	#	1	1	3	METS Assumption	
Feed Rate (Solids)	dt/h	7	7.91	2	METS Calculated Value	
Feed Rate (Slurry)	m <sup>3</sup> /h	3867	4,640	2	METS Calculated Value	
Feed % Solids	w/w %	0.19	0.19	2	METS Calculated Value	
Underflow % Solids	w/w %	50	50	3	METS Assumption	
Underflow Solids Rate	dt/h	7	7.91	2	METS Calculated Value	
Underflow Liquid	t/h	7	7.91	2	METS Calculated Value	
Underflow Slurry Rate	t/h	13	15.82	2	METS Calculated Value	
Underflow Slurry Rate	m <sup>3</sup> /h	9	10.73	2	METS Calculated Value	
Underflow Density	t/m <sup>3</sup>	1.47	1.47	2	METS Calculated Value	
Overflow % Solids	w/w %	0.00	0.00	3	METS Assumption	
Overflow Solids Rate	dt/h	0.00	0.00	2	METS Calculated Value	
Overflow Liquid	t/h	3858	4630	2	METS Calculated Value	
Overflow Slurry Rate	t/h	3858	4630	2	METS Calculated Value	
Overflow Slurry Rate	m <sup>3</sup> /h	3858	4630	2	METS Calculated Value	
Overflow Density	t/m <sup>3</sup>	1.00	1.00	2	METS Calculated Value	
Flocculant Dosage	g/t	100	100	3	METS Assumption	
Floc Rate	kg/h	0.66	0.79	2	METS Calculated Value	
Settling Rate	m <sup>2</sup> /h/d	6.00	6.00	3	METS Assumption	
Thickener Cross Sectional Area (Minimum)	m <sup>2</sup>	39.54	47.45	2	METS Calculated Value	
Thickener Diameter (Minimum)	m	7	8.51	2	METS Calculated Value	
Upflow Rate	m/h	97.57	117.08	2	METS Calculated Value	
Residence time	h	TBD	TBD			
Thickener Volume	m <sup>3</sup>	TBD	TBD			
<b>pH Adjustment Filter Feed Tank (400-HP-01)</b>						
Residence Time	min	90	90	3	METS Assumption	
Slurry Flow	m <sup>3</sup> /h	9	11	2	METS Calculated Value	
Volume	m <sup>3</sup>	14	17	2	METS Calculated Value	
<b>pH Adjustment Filter Press (400-FL-01/02)</b>						
Type	-	Pressure	Pressure	3	METS Assumption	
Number of Filter Units	#	1	2	3	METS Assumption	
Feed Rate (per Unit)	dt/h	7	8	2	METS Calculated Value	
% Solids						
Feed	w/w %	50	50	3	METS Assumption	
Cake	w/w %	15%	15%	3	METS Assumption	
Filtration Rate	kg/m <sup>2</sup> /h	80	80	3	METS Assumption	
Filter Area (per Unit)	m <sup>2</sup>	41	49	2	METS Calculated Value	
Filter Cake Discharge	wet	t/h	8	9	2	METS Calculated Value
Solids Discharge	dt/h	7	8	2	METS Calculated Value	
Cake Moisture	t/h	1	1	2	METS Calculated Value	
<b>SX Feed Polishing Filter (400-FL-03/04/05)</b>						
Type	-	Polishing	Polishing	3	METS Assumption	
Number of Filter Units	#	4	4	3	METS Assumption	
Feed Rate (per Unit)	m <sup>3</sup> /h	965	1,157	2	METS Calculated Value	
Filter Area (per Unit)	m <sup>2</sup>	TBC	TBC			
Filter Cake Discharge	wet	t/h	TBC	TBC		
Solids Discharge	dt/h	TBC	TBC			
Cake Moisture	t/h	TBC	TBC			
Filtrate	m <sup>3</sup> /h	3,858	4,630	2	METS Calculated Value	
<b>SX PLS Feed Tank (400-TK-02)</b>						
Residence Time	min	10	10	3	METS Assumption	
PLS Flowrate	m <sup>3</sup> /h	3,858	4,630	2	METS Calculated Value	
Volume	m <sup>3</sup>	644	773	2	METS Calculated Value	
<b>Copper Extraction Mixer Settler (400-SX-01/02)</b>						
Number of Cells	#	2	2	3	METS Assumption	
Volume/Cell Minimum (Mixer)	m <sup>3</sup>	193	231	2	METS Calculated Value	
Volume/Cell Minimum (Settler)	m <sup>3</sup>	1,029	1,235	2	METS Calculated Value	
Residence Time (Mixer)	min	1.50	1.50	3	METS Assumption	
Residence Time (Settler)	min	8.00	8.00	3	METS Assumption	
Feed Rate	m <sup>3</sup> /h	3,858	4,630	2	METS Calculated Value	

**J5329 - Deep-South - Haib Copper Project - Process Design Criteria**

Description	Units	Nominal	Design	Ref	Comments
O/A Ratio		1:1	1:1	3	METS Assumption
Organic in Solvent	%	15	15	3	METS Assumption
Organic Feed Rate	m <sup>3</sup> /h	3,858	4,630	2	METS Calculated Value
LIX Loss Rate	m <sup>3</sup> /h	0.069	0.083	2	METS Calculated Value
Organic Makeup	m <sup>3</sup> /h	0.46	0.56	2	METS Calculated Value
Organic Diluent Loss Rate	m <sup>3</sup> /h	0.39	0.47	2	METS Calculated Value
Temperature	°C	Ambient	Ambient	3	METS Assumption
pH Initial		2.00	2.00	2	METS Calculated Value
Discharge Rate (Loaded Organic)	m <sup>3</sup> /h	3,858	4,630	2	METS Calculated Value
Organic Recovery	%	99.988%	99.988%	3	METS Assumption
Mixer Diameter		TBD	TBD		
Mixer Height		TBD	TBD		
Settler Width		TBD	TBD		
Settler Area Settler Length		TBD	TBD		
Copper Extraction	%	98%	98%	3	METS Assumption
Impurities Extraction	%	0%	0%	3	METS Assumption
<b>Loaded Organic Tank (400-TK-04)</b>					
Organic Feed	m <sup>3</sup> /h	3858	4630	2	METS Calculated Value
Residence Time	h	0.08	0.08	3	METS Assumption
Tank Capacity	m <sup>3</sup>	322	386	2	METS Calculated Value
<b>Copper Stripping Mixer Settler (400-SX-03/04)</b>					
Number of Cells	#	2	2	3	METS Assumption
Volume/Cell Minimum (Mixer)	m <sup>3</sup>	102	123	2	METS Calculated Value
Volume/Cell Minimum (Settler)	m <sup>3</sup>	545	654	2	METS Calculated Value
Residence Time (Mixer)	min	1.50	1.50	3	METS Assumption
Residence Time (Settler)	min	8.00	8.00	3	METS Assumption
Organic Feed Rate	m <sup>3</sup> /h	3,858	4,630	2	METS Calculated Value
O/A	-	16:1	16:1	3	METS Assumption
Stripping Solution Feed Rate	m <sup>3</sup> /h	227.3	272.8	3	METS Assumption
Temperature	°C	Ambient	Ambient	3	METS Assumption
Organic Discharge Rate	m <sup>3</sup> /h	3,858	4,630	2	METS Calculated Value
Aqueous Discharge Rate	m <sup>3</sup> /h	227.3	272.8	2	METS Calculated Value
H <sub>2</sub> SO <sub>4</sub> Concentration	g/L	200.00	200.00	3	METS Assumption
H <sub>2</sub> SO <sub>4</sub> (100%) Required	t/h	45.5	45.5	2	METS Calculated Value
H <sub>2</sub> SO <sub>4</sub> (100%) Recycled	t/h	43.2	51.8	2	METS Calculated Value
H <sub>2</sub> SO <sub>4</sub> (100%) Makeup	t/h	2.3	2.7	2	METS Calculated Value
Temperature	°C	Ambient	Ambient	3	METS Assumption
pH	pH	-0.61	-0.61	2	METS Calculated Value
Split to Electrowinning	%	100	100	3	METS Assumption
Stripping Efficiency	%	100	100	3	METS Assumption
<b>Organic Control Tank (400-TK-03)</b>					
Organic Feed	m <sup>3</sup> /h	3858	4630	2	METS Calculated Value
Residence Time	h	0.08	0.08	3	METS Assumption
Tank Capacity	m <sup>3</sup>	322	386	2	METS Calculated Value
<b>Stripping Liquor Makeup Tank (400-TK-05)</b>					
Feed	m <sup>3</sup> /h	227.3	272.8	2	METS Calculated Value
Residence Time	h	0.08	0.08	3	METS Assumption
Tank Capacity	m <sup>3</sup>	19	23	2	METS Calculated Value
<b>Copper Electrowinning Cells (400-EC-01--244)</b>					
Number of Cells	#	244	244	3	METS Assumption
Electrowin Time	days	TBD	1.00		
Cell Volume	m <sup>3</sup>	TBD	519.6		
Flowrate	m <sup>3</sup> /h	1.0	1.1	2	METS Calculated Value
Current Density	A/m <sup>2</sup>	282.0	282.0	3	METS Assumption
Cell Voltage	V	2.0	2.0	3	METS Assumption
Cathode Material	-	Stainless Steel Blank Cathodes		3	METS Assumption
Cathode Cleaning	-	High Pressure Water		3	METS Assumption
Cathode Cleaning Frequency	per week	1.0	1.0	3	METS Assumption
Water Requirement for Cathode Cleaning	m <sup>3</sup> /clean	15.0	18.0	3	METS Assumption
Electrowinning Efficiency	%	100		3	METS Assumption



**J5329 - Deep-South - Haib Copper Project - Process Design Criteria**

Description	Units	Nominal	Design	Ref	Comments	
<b>Area 500- Iron Precipitation</b>						
<b>Iron Precipitation Tank (500-TK-01)</b>						
Number of Tanks	#	1.0		3	METS Assumption	
pH		5.8		3	METS Assumption	
Temperature	°C	40		3	METS Assumption	
Feed Rate	t/h	1,543		2	METS Calculated Value	
Lime Addition Rate	dt/h	1.8	2.2	2	METS Calculated Value	
Lime Density	t/m <sup>3</sup>	1.2	1.2	3	METS Assumption	
Limestone/Calcrete	dt/h	3.3	3.9	2	METS Calculated Value	
Residence Time	h	0.2	0.2	2	METS Calculated Value	
Discharge Rate	t/h	1,551	1,550.6	2	METS Calculated Value	
Capacity	m <sup>3</sup>	259	310.8	3	METS Assumption	
<b>Iron Precipitate Thickener (500-TH-01)</b>						
Type of Thickener	-		High Rate	3	METS Assumption	
No. of Thickeners	#	1	1.00	3	METS Assumption	
Feed Rate (Solids)	dt/h	154	184.23	2	METS Calculated Value	
Feed Rate (Slurry)	m <sup>3</sup> /h	1425	1,709.76	2	METS Calculated Value	
Feed % Solids	w/w %	10.1	10.1	2	METS Calculated Value	
Underflow % Solids	w/w %	50	50	3	METS Assumption	
Underflow Solid Rate	dt/h	154	184.23	2	METS Calculated Value	
Underflow Liquid	t/h	154	184.23	2	METS Calculated Value	
Underflow Slurry Rate	t/h	307	368.47	2	METS Calculated Value	
Underflow Slurry Rate	m <sup>3</sup> /h	208	250.03	2	METS Calculated Value	
Underflow Density	t/m <sup>3</sup>	1.47	1.47	2	METS Calculated Value	
Overflow % Solids	w/w %	0.00	0.00	3	METS Assumption	
Overflow Solid Rate	dt/h	0.00	0.00	2	METS Calculated Value	
Overflow Liquid	t/h	1,244	1,492.24	3	METS Assumption	
Overflow Slurry Rate	t/h	1,244	1,492.24	2	METS Calculated Value	
Overflow Slurry Rate	m <sup>3</sup> /h	1,244	1,492.24	2	METS Calculated Value	
Overflow Density	t/m <sup>3</sup>	1.00	1.00	3	METS Assumption	
Floculant Dosage	g/t	100	100	3	METS Assumption	
Floc Rate	kg/h	15.35	18.42	2	METS Calculated Value	
Settling Rate	m <sup>2</sup> /d	6.00	6.00	3	METS Assumption	
Thickener Cross Sectional Area (Minimum)	m <sup>2</sup>	921	1,105.40	2	METS Calculated Value	
Thickener Diameter (Minimum)	m	34	41.10	2	METS Calculated Value	
Upflow Rate	m/h	1.35	1.62	2	METS Calculated Value	
Residence Time	h	TBD	TBD			
Thickener Volume	m <sup>3</sup>	TBD	TBD			
<b>Iron Tailings Filter Feed Tank (500-TK-02)</b>						
Residence Time	min	30	30	3	METS Assumption	
Slurry Flow	m <sup>3</sup> /h	208	250	2	METS Calculated Value	
Volume	m <sup>3</sup>	105	126	2	METS Calculated Value	
<b>Iron Tailings Filter Press (500-FL-01/02)</b>						
Type	-		Pressure	TBD	3	METS Assumption
Number of Filter Units	#	2.00	2.00	3	METS Assumption	
Feed Rate (per Unit)	dt/h	76.8	92.12	2	METS Calculated Value	
% Solids						
Feed	w/w %	50	50	3	METS Assumption	
Cake	w/w %	10	10	3	METS Assumption	
Filtration Rate	kg/m <sup>2</sup> /h	80.00	80	3	METS Assumption	
Filter Area (per Unit)	m <sup>2</sup>	480	575.7	2	METS Calculated Value	
Filter Cake Discharge	wet t/h	180.6	216.7	2	METS Calculated Value	
Solids Discharge	dt/h	153.5	184.2	2	METS Calculated Value	
Cake Moisture	t/h	27.09	32.5	2	METS Calculated Value	
<b>Raffinate Recycle Tank (500-TK-03)</b>						
Residence Time	minutes	5	5	3	METS Assumption	
Flow from Filtrate	m <sup>3</sup> /h	181	217	2	METS Calculated Value	
Flow From Thickener	m <sup>3</sup> /h	1,244	1,492	2	METS Calculated Value	
Flow rate (Total)	m <sup>3</sup> /h	1,424	1,709	2	METS Calculated Value	
Volume	m <sup>3</sup>	119	143	2	METS Calculated Value	
<b>Area 600 - Process and Raw Water</b>						
<b>Raw Water Dam (600-DM-01/02)</b>						
Raw Water Requirement	m <sup>3</sup> /h	300	360	2	METS Calculated Value	
Raw Water Requirement	m <sup>3</sup> /d	7,193	8,631	2	METS Calculated Value	
Residence Time	d	5	5	3	METS Assumption	
Storage Capacity	m <sup>3</sup>	36,000	43,200	2	METS Calculated Value	
<b>Raw Water Tank (600-TK-02)</b>						
Raw Water Requirement	m <sup>3</sup> /h	300	360	2	METS Calculated Value	
Raw Water Requirement	m <sup>3</sup> /d	7,193	8,631	2	METS Calculated Value	
Residence Time	d	1	1	3	METS Assumption	
Storage Capacity	m <sup>3</sup>	7,200	8,640	2	METS Calculated Value	
<b>Process Water Tank (600-TK-01/03)</b>						
Process Water Drawdown	m <sup>3</sup> /h	60	72	3	METS Assumption	
Raw Water Requirement	m <sup>3</sup> /h	15	18	3	METS Assumption	
Residence Time	d	1	1	3	METS Assumption	
Storage Capacity	m <sup>3</sup>	1,500	1,800	2	METS Calculated Value	
<b>Raw Water</b>						
Supply Source			Orange River			
Analysis						
pH			TBD			
E Coli			TBD			
Copper	ppm		TBD			
Iron	ppm		TBD			
Cobalt	ppm		TBD			
Nickel	ppm		TBD			
TSS	ppm		TBD			

**J5329 - Deep-South - Haib Copper Project - Process Design Criteria**

Description	Units	Nominal	Design	Ref	Comments
TDS	ppm	TBD			
Total Sulphate	ppm	TBD			
<b>Potable Water Quality</b>					
pH	-	6.5-8	8.00		
Conductivity	µS/cm	TBD	5.80		
Total Dissolved Solids	mg/l	TBD	500		
Total Hardness as CaCO <sub>3</sub>	mg/l	TBD	200		
Na <sup>+</sup>	mg/l	TBD	180		
Cl <sup>-</sup>	mg/l	TBD	250		
Cl <sub>2</sub>	mg/l	TBD	5.00		
SO <sub>4</sub>	mg/l	TBD	250		
<b>Area 700- Reagents</b>					
<b>LIX-984N</b>					
Supply Method	-	Bulk		3	METS Assumption
Supply Form	-	Liquid		3	METS Assumption
Supply Bulk Density	t/m <sup>3</sup>	0.88	-	4	Market Specification
Storage Tank Residence Time	h	48	48.00	3	METS Assumption
Storage Tank Capacity	m <sup>3</sup>	4.00	9.60	2	METS Calculated Value
Mixing Tank Capacity	m <sup>3</sup>	3.00	7.20	2	METS Calculated Value
Mixing Tank Residence Time	h	5	5.00	3	METS Assumption
O in Solvent	%w/w	15	15	3	METS Assumption
Addition	m <sup>3</sup> /h	0.07	0.07	2	METS Calculated Value
Raw Diluent for Mixing	m <sup>3</sup> /h	0.39	0.39	2	METS Calculated Value
<b>Kerosene</b>					
Supply Method	-	Bulk		3	METS Assumption
Supply Form	-	Liquid		3	METS Assumption
Supply Bulk Density	t/m <sup>3</sup>	0.81		3	METS Assumption
Kerosene Process Feed	m <sup>3</sup> /h	0.39	0.47	2	METS Calculated Value
Storage Residence Time	h	24	24	3	METS Assumption
Storage Tank Capacity	m <sup>3</sup>	10.00	12.00	2	METS Calculated Value
<b>Quicklime</b>					
Supply Method	-	Bulk		3	METS Assumption
Supply Form	-	Solid		3	METS Assumption
Supply Density	t/m <sup>3</sup>	3.35		7	Other Sources
Supply Bulk Density	t/m <sup>3</sup>	0.88		7	Other Sources
Storage Residence Time	h	24	-	3	METS Assumption
Process Lime Requirement	t/h	1.83	2.19	2	METS Calculated Value
Raw Water for Mixing	m <sup>3</sup> /h	5.49	6.58	2	METS Calculated Value
Storage Silo Volume	m <sup>3</sup>	50	60	2	METS Calculated Value
Distribution Tank Residence Time	h	1	1	3	METS Assumption
Distribution Tank Volume	m <sup>3</sup>	7.00	8.40	2	METS Calculated Value
% Solids	%w/w	25%	25%	3	METS Assumption
<b>Limestone/Cicrete</b>					
Supply Method	-	Bulk		3	METS Assumption
Supply Form	-	Solid		3	METS Assumption
Supply Density	t/m <sup>3</sup>	2.60	-	7	Other Sources
Storage Residence Time	h	24	-	3	METS Assumption
Process Requirement	t/h	8.11	9.73	2	METS Calculated Value
Raw Water for Mixing	m <sup>3</sup> /h	24.33	29.19	2	METS Calculated Value
Storage Silo Volume	m <sup>3</sup>	75	90	2	METS Calculated Value
Distribution Tank Residence Time	h	1	1	3	METS Assumption
Distribution Tank Volume	m <sup>3</sup>	28.00	33.60	2	METS Calculated Value
% Solids	%w/w	25%	25%	3	METS Assumption
<b>Sulphuric Acid</b>					
Supply Method	-	Bulk Bag		3	METS Assumption
Supply Form	-	S, Powder		3	METS Assumption
H <sub>2</sub> SO <sub>4</sub> Density	t/m <sup>3</sup>	1.84	-	3	METS Assumption
H <sub>2</sub> SO <sub>4</sub> Process Requirement	t/h	2.45	-	2	METS Calculated Value
H <sub>2</sub> SO <sub>4</sub> Process Requirement	m <sup>3</sup> /h	1.33	1.60	2	METS Calculated Value
H <sub>2</sub> SO <sub>4</sub> Storage Residence Time	h	24	24	3	METS Assumption
H <sub>2</sub> SO <sub>4</sub> Storage Tank Capacity	m <sup>3</sup>	32	38.40	2	METS Calculated Value
<b>Binder</b>					
Supply Method	-	Bulk Bag		3	METS Assumption
Supply Form	-	Solid		3	METS Assumption
Supply Bulk Density	t/m <sup>3</sup>	1.00	-	3	METS Assumption
Storage Residence Time	h	12	-	3	METS Assumption
Binder Consumption	kg/t	0.50	0.50	3	METS Assumption
Process Requirement	t/h	0.4	0.44	2	METS Calculated Value
Binder Feed Hopper Capacity	m <sup>3</sup>	5.0	6.00	2	METS Calculated Value
<b>Flocculant</b>					
Type	-	Magnafloc 155	-	3	METS Assumption
Supply Method	-	25 kg Bags	-	3	METS Assumption
Supply Form	-	Solid	-	3	METS Assumption
Flocculant Mixing Tank Residence Time	h	2	-	3	METS Assumption
Flocculant Storage Tank Residence Time	h	24	-	3	METS Assumption
Flocculant Mixing Tank Capacity	L	10	-	2	METS Calculated Value
Flocculant Storage Tank Capacity	m <sup>3</sup>	1	-	2	METS Calculated Value
Bulk Density	t/m <sup>3</sup>	0.75	-	7	Other Sources
Total Addition Rate	kg/h	16.01	19.21	3	METS Assumption
Addition Concentration	%w/v	25	25	3	METS Assumption
Inline Mixer Dilution	%w/v	2.5	2.5	3	METS Assumption
Viscosity (After dilution)	cP	300	300	3	METS Assumption
Addition Concentration (Belt Filter)	%w/v	25	25	3	METS Assumption
Raw Water for Mixing	m <sup>3</sup> /h	0.000854	0.001025	2	METS Calculated Value
<b>Area 800- Services</b>					
<b>Air Compressor</b>					
HP Air Compressor Type	-	Screw		3	METS Assumption



**Client** Deep-South Resources  
**Project** Haib Copper Project  
**Job #** J5329  
**Doc #** J5329-P-PDC-000-001  
**Doc Title** Process Design Criteria 20 Mtpa @ 85% Cu Recovery  
**Rev** A

**J5329 - Deep-South - Haib Copper Project - Process Design Criteria**

Description	Units	Nominal	Design	Ref	Comments
HP Air Pressure	kPa	750		3	METS Assumption
HP Air Compressor Capacity	Nm <sup>3</sup> /h	250	300	3	METS Assumption
<b>Plant Air Filter</b>					
Type					
<b>Plant Air Receiver</b>					
Type	-	Standard Receiver Vessel		3	METS Assumption
HP Air Receiver Volume	L			3	METS Assumption
<b>Instrument Air</b>					
Instrument Air Pressure	kPa	750		3	METS Assumption
HP Air Compressor Capacity	m <sup>3</sup> /h				

**J5329 - Deep-South - Haib Copper Project - Process Design Criteria**

	Description	Units	Nominal	Design	Ref	Comments
<b>Site Characteristics</b>						
<b>Haib Copper Project</b>						
	Latitude	-	28°41'-29 S			
	Longitude	-	17°51'18 E			
	Elevation	masl	157		1	Noordewer (closest town)
	Mean Annual Rainfall	mm/a	25-50		1	
	Highest 24 Hour Rainfall Event	mm	47.0		1	
	Winter Dry Bulb Temperature	°C	15.8		1	
	Winter Wet Bulb Temperature	°C	8.6		1	Tempure at Windhoek
	Summer Dry Bulb Temperature	°C	40.0		1	Nambia desert Max temp
	Summer Wet Bulb Temperature	°C	35.0		1	
	Summer Daily Range Temperature	°C	20.00		1	
	Maximum Wind Velocity	km/h	15.8		1	Source: Namibia Weather 2019
<b>Operating Criteria</b>						
<b>Haib Copper Project</b>						
	Resource	Mt	456.9	456.9	1	Client Supplied Data
	Estimated Project Life	yr	23	19	3	METS Assumption
	Days per Year	Days	365	365	7	Other Sources
	Hours per Day	h	24	24	7	Other Sources
	Crusher Availability	%	70%	70%	3	METS Assumption
	Plant Availability	%	90%	90%	3	METS Assumption
	Heap Leach Availability	%	98%	98%	3	METS Assumption
	Plant Utilisation	%	90%	90%	3	METS Assumption
	Feed Moisture	%	3%	3%	3	METS Assumption
	Plant Throughput	t/a	20,000,000	24,000,000	3	METS Assumption
	Plant Throughput	t/h	2,537	3,044	2	METS Calculated Value
	Crusher Throughput	t/h	3,262	3,914	2	METS Calculated Value
	Crusher Operating Hours per Annum	h	6,132	6,132	3	METS Assumption
	Plant Operating Hours per Annum	h	7884	7884	1	Client Supplied Data
	Average Copper Head Grade	%	0.310	0.310	1	Client Supplied Data
	Overall Copper Recovery	%	85	0	2	METS Calculated Value
	Copper Recovered per Annum	t/yr	51077	tpa	3	METS Assumption
<b>Comminution Characteristics</b>						
	Abrasion Index (AI)	-	0.49	0.49	1	Client Supplied Data
	Ore Density	t/m <sup>3</sup>	2.8	2.8	1	Client Supplied Data
	Ore Bulk Density	t/m <sup>3</sup>	1.8	1.8	1	Client Supplied Data
	Crushing Work Index (CWi)	kWh/t	22.3	22.3	1	Client Supplied Data
	Bond Ball Mill Work Index (BWi)	kWh/t	18.0	18.0	1	Client Supplied Data
	Bond Rod Mill Work Index (RWI)	kWh/t	21.6	21.6	1	Client Supplied Data
	Angle of Repose	degrees	36	36	1	Client Supplied Data
	Angle of Reclaim	degrees	55	55	1	Client Supplied Data
<b>Area 100-Primary and Secondary Crushing</b>						
<b>Crushing Design Basis</b>						
	Throughput Operating	t/h	3,262	3,914	2	METS Calculated Value
<b>Plant Feed Size</b>						
	ROM Feed Size	F <sub>100</sub> mm	800	800	3	METS Assumption
<b>Crushing Product Size</b>						
	Screen Undersize	P <sub>20</sub> mm	5.7	5.3	3	METS Assumption
<b>ROM Bin (100-BN-01)</b>						
	Residence Time	h	0.25	0.25	3	METS Assumption
	Capacity	t	815	978	2	METS Calculated Value
	Volume	m <sup>3</sup>	291	349	2	METS Calculated Value
<b>Gyratory Crusher (100-CR-01)</b>						
	Configuration			Open Circuit		
	Type			Sandvik CG830i		
	Number of Units		1	1	3	METS Assumption
	Feed Rate	t/h	3,262	3,914	2	METS Calculated Value
	Feed Size	F <sub>80</sub> mm	495	495	2	METS Calculated Value
	Product Size	P <sub>80</sub> mm	150	150	2	METS Calculated Value
	Closed Setting	mm	177	177	2	METS Calculated Value
	Stroke	mm	38	38	2	METS Calculated Value
	Crusher Power Rating	kW	1,100	1,100	6	Vendor Supplied Data
<b>Gyratory Crusher Discharge Conveyor (100-CV-01)</b>						
	Feed Rate	t/h	3,262	3,914	2	METS Calculated Value
<b>Cone Crusher Feed Bins (100-BN-02/03/04/05/06)</b>						
	Combined Throughput	t/h	4,807	6,408	2	METS Calculated Value
	Units	-	5	5	3	METS Assumption
	Residence Time	h	0.50	0.50	3	METS Assumption
	Capacity per Bin	t	481	641	2	METS Calculated Value
	Volume per Bin	m <sup>3</sup>	267	356	2	METS Calculated Value
<b>Cone Crushers (100-CR-02/03/04/05/06)</b>						
	Type			Sandvik CH870i:03		
	No. of Units	#	5	5	3	METS Assumption
	Cavity Type	-	Standard Fine	Standard Medium		
	Feed Rate	Per Unit t/h	961	1282	2	METS Calculated Value

**J5329 - Deep-South - Haib Copper Project - Process Design Criteria**

Description	Units	Nominal	Design	Ref	Comments
Feed Size	F <sub>80</sub> mm	132	126	2	METS Calculated Value
Product Size	P <sub>80</sub> mm	31	40	2	METS Calculated Value
Closed Size Setting	mm	25	25	3	METS Assumption
Power Rating	Per Unit kW	746	746	6	Vendor Supplied Data
<b>Cone Crusher Screen (100-SC-01/02/03)</b>					
Type		Metso TS5.2 Double-Deck Banana			
Feed Rate	t/h	4,807	6,408	2	METS Calculated Value
Screen Area	m <sup>2</sup>	60	60	6	Vendor Supplied Data
No. of Units	#	3	3	3	METS Assumption
Product Size	P <sub>80</sub> mm	20.7	27.8	2	METS Calculated Value
Screen Flow Rates	O/S t/h	1,545	2,494	2	METS Calculated Value
	U/S t/h	3,262	3,914	2	METS Calculated Value
Deck 1 Screen Aperture	mm	50	45	3	METS Assumption
Deck 2 Screen Aperture	mm	30	35	3	METS Assumption
<b>Crushed Ore Stockpile</b>					
Ore Delivery		Conveyor			
Feed Rate	t/h	3,262	3,914	2	METS Calculated Value
Number of Reclaim Chutes	#	2	2	3	METS Assumption
Live Stockpile Residence Time	h	12	12	3	METS Assumption
Live Stockpile Capacity	t	39,139	46,967	2	METS Calculated Value
Live Stockpile Volume	m <sup>3</sup>	21,744	26,093	2	METS Calculated Value
Total Stockpile Volume	m <sup>3</sup>	86,975	104,371	3	METS Assumption
Stockpile Diameter	m	49	52	2	METS Calculated Value
<b>Crushing plant to the Processing Plant Conveyor (100-CV-07)</b>					
Feed Rate	t/h	3,262	3,914	2	METS Calculated Value
Length	m	TBD	TBD		
<b>Area 200- Tertiary Crushing</b>					
<b>HPGR Feed Stockpile</b>					
Ore Delivery		Conveyor			
Feed Rate	t/h	3,262	3,914	2	METS Calculated Value
Discharge Chutes	#	2	2	3	METS Assumption
Discharge Rate	t/h	2,537	3,044	2	METS Calculated Value
Live Stockpile Residence Time	h	48	48	3	METS Assumption
Live Stockpile Capacity	t	121,766	146,119	2	METS Calculated Value
Live Stockpile Volume	m <sup>3</sup>	67,648	81,177	2	METS Calculated Value
Total Stockpile Volume	m <sup>3</sup>	270,590	324,708	3	METS Assumption
Stockpile Diameter	m	71	75	2	METS Calculated Value
<b>HPGR Design Basis</b>					
Availability	%	90.00	90.00	3	METS Assumption
Throughput	t/h	2,537	3,044	2	METS Calculated Value
Fresh Feed Size	mm	20.65	27.80	2	METS Calculated Value
<b>HPGR Feed Bin (200-BN-01/02)</b>					
Fresh Feed	t/h	2,537	3,044	2	METS Calculated Value
No. of Units	#	2	2	3	METS Assumption
Recycle to Fresh Feed Ratio	%	30	30	3	METS Assumption
Recycle Rate	t/h	761	913	2	METS Calculated Value
Feed Rate Total	t/h	3,298	3,957	2	METS Calculated Value
Residence Time	h	0.50	0.50	3	METS Assumption
Capacity per Bin	t	824	989	2	METS Calculated Value
Volume per Bin	m <sup>3</sup>	458	550	2	METS Calculated Value
<b>HPGR (200-GR-01/02)</b>					
Vendor		Koppers			
Type		900-22.8-ONH 1600 PG1E			
Number	#	2.00	2.00		
Roll Speed	m/s	2.00	2.00	6	Vendor Supplied Data
Roll Length	mm	1500	1500	6	Vendor Supplied Data
Roll Diameter	mm	2000	2000	6	Vendor Supplied Data
Feed Rate (per Unit)	t/h	1,649	1,979	2	METS Calculated Value
Feed Size	F <sub>80</sub> mm	19.30	22.80	3	METS Assumption
Product Size	P <sub>80</sub> mm	8.70	9.50	3	METS Assumption
Power Rating	kW	3800	3800	3	METS Assumption
<b>HPGR Screen (200-SC-02)</b>					
Type		Metso TS5.2 Double-Deck Banana			3 METS Assumption
Feed Rate	t/h	3,298	3,957	2	METS Calculated Value
Screen Area	m <sup>2</sup>	80	80	6	Vendor Supplied Data
No of Units	#	4	4	3	METS Assumption
Product Size , P80	mm	5.7	5.3	3	METS Assumption
Screen Flow Rates	O/S t/h	761	913	2	METS Calculated Value
	U/S t/h	2,537	3,044	2	METS Calculated Value
Screen Aperture	Top mm	16	16	3	METS Assumption
	Middle mm	11	11	3	METS Assumption
% Reporting to U/S	%	70	70	3	METS Assumption
<b>Area 300- Agglomeration and Heap Leaching</b>					
<b>Leaching Design Basis</b>					
Feed Rate Solids	dt/h	2461	3044	2	METS Calculated Value
Feed Rate	t/h	2537	3044	2	METS Calculated Value

**J5329 - Deep-South - Haib Copper Project - Process Design Criteria**

Description	Units	Nominal	Design	Ref	Comments
Feed % Solids	w/w %	88.0	88.0	3	METS Assumption
Acid Consumption Rate	kg/t ore	10	12	3	METS Assumption
Barren Pond H <sub>2</sub> SO <sub>4</sub> Concentration	g/L	1.4	1.4	2	METS Calculated Value
Solution pH	-	0.0	0.0	2	METS Calculated Value
Total Acid Solution Rate	m <sup>3</sup> /h	3822	4587	2	METS Calculated Value
Binder Addition	kg/t	0.37	0.44	3	METS Assumption
Leach Extent Cu	%	85	85	5	Testwork Supplied Data
Leach Extent Al	%	20	20	5	Testwork Supplied Data
Leach Extent Fe	%	20	20	5	Testwork Supplied Data
Temperature	°C	40	40	3	METS Assumption
Total Residence Time	days	400	400	3	METS Assumption
Heap Evaporation Losses	%	2	2	3	METS Assumption
Pond Evaporation Losses	mm/day	8	8	3	METS Assumption
<b>Irrigation (300-IR-01-03)</b>					
Number of Leach Stages	#	3.00	3.00	3	METS Assumption
Irrigation Solution		Dilute Sulphuric Acid		3	METS Assumption
Irrigation Rate	L/h/m <sup>2</sup>	10.00	10.00	3	METS Assumption
Irrigation Type		Drippers		3	METS Assumption
Irrigation Solution Density	t/m <sup>3</sup>	1.00	1.00	3	METS Assumption
<b>Agglomerator Feed Bin (300-BN-01)</b>					
Residence Time	min	15	15	3	METS Assumption
Wet Solids Flow	m <sup>3</sup> /h	1,409	1,691	2	METS Calculated Value
Volume	m <sup>3</sup>	352	423	2	METS Calculated Value
<b>Agglomeration Drum (300-AD-01/02/03/04)</b>					
Model/Type	-	Rotary Drum		6	Vendor Supplied Data
No. of Units	#	4	4	3	METS Assumption
Feed Rate	dt/h	2,461	2,953	2	METS Calculated Value
Feed Rate	Wet t/h	2,537	3,044	2	METS Calculated Value
Water Addition	t/h	259.4	311.2	2	METS Calculated Value
Feed Rate	per unit t/h	699	839	2	METS Calculated Value
Total Mass Feed Rate	m <sup>3</sup> /h	1,668.7	2,002.4	2	METS Calculated Value
Percent Fill	%	20%	20%	3	METS Assumption
Void Volume	%	50%	50%	3	METS Assumption
Binder Addition	t/h	0.4	0.4	2	METS Calculated Value
Sulphuric Acid Addition	t/h	0.1	0.2	2	METS Calculated Value
Solids Content	%	88	88	3	METS Assumption
Residence Time	h	0.02	0.02	3	METS Assumption
Drum Minimum Volume	m <sup>3</sup>	166.9	200.2	2	METS Calculated Value
Drum Designed Volume	m <sup>3</sup>	333.7	400.5	2	METS Calculated Value
Solids Discharge Rate	dt/h	2,461	2,953	2	METS Calculated Value
Wet Solids Discharge Rate	t/h	2,797	3,356	2	METS Calculated Value
Wet Solids Bulk Density	t/m <sup>3</sup>	2.0	2.0	3	METS Assumption
<b>Primary Heap</b>					
Ore Delivery				3	METS Assumption
Feed Rate	t/h	2797	3356	2	METS Calculated Value
Irrigation Rate	L/h/m <sup>2</sup>	10.00	10.00	3	METS Assumption
Irrigation Solution		ILS		3	METS Assumption
Temperature	°C	40.00	40.00	3	METS Assumption
Irrigation Solution pH		TBD	TBD	3	METS Assumption
Heap Moisture	%	12	12	3	METS Assumption
Live Stockpile	days	120	120	3	METS Assumption
Live Stockpile Capacity	t	7,893,255	9471906	2	METS Calculated Value
Leach Extent Cu	%	TBD	TBD		
Leach Extent Mo	%	TBD	TBD		
Leach Extent Al	%	TBD	TBD		
Leach Extent Fe	%	TBD	TBD		
Leachant Discharge Rate	m <sup>3</sup> /h	3,822	3,822	2	METS Calculated Value
Heap Lift Height	m	10.0	10.0	3	METS Assumption
Heap Width	m	120.00	144.00	2	METS Calculated Value
Heap Length	m	500.00	600.00	2	METS Calculated Value
Heap Height	m	40.00	48.00	2	METS Calculated Value
Heap Evaporation Loss	%	2	2	3	METS Assumption
<b>Secondary Heap</b>					
Irrigation Rate	L/h/m <sup>2</sup>	10.00	10.00	3	METS Assumption
Irrigation Solution		Barren		3	METS Assumption
Temperature	°C	40.00	40.00	3	METS Assumption
Irrigation Solution pH		TBD	TBD	3	METS Assumption
Heap Moisture	%	12	12	3	METS Assumption
Live Stockpile	days	120	120	3	METS Assumption
Live Stockpile Capacity	t	7,893,255	9471906	2	METS Calculated Value
Leach Extent Cu	%	TBD	TBD		
Leach Extent Mo	%	TBD	TBD		
Leach Extent Al	%	TBD	TBD		
Leach Extent Fe	%	TBD	TBD		
Leachant Discharge Rate	m <sup>3</sup> /h	3,822	4,587	2	METS Calculated Value
Heap Lift Height	m	10.00	12.00	3	METS Assumption
Heap Width	m	120.00	144.00	2	METS Calculated Value
Heap Length	m	500.00	600.00	2	METS Calculated Value
Heap Height	m	40.00	48.00	2	METS Calculated Value

**J5329 - Deep-South - Haib Copper Project - Process Design Criteria**

Description	Units	Nominal	Design	Ref	Comments
Heap Evaporation Loss	%	2	2	3	METS Assumption
<b>Washing Heap</b>					
Irrigation Rate	L/h/m <sup>2</sup>	10.00	10.00	3	METS Assumption
Irrigation Solution	-	Barren		3	METS Assumption
Temperature	°C	40.00	40.00	5	Testwork Supplied Data
Irrigation Solution pH	-	4.85	4.85	3	METS Assumption
Heap Moisture	%	12	12	3	METS Assumption
Live Stockpile	days	160	160	2	METS Calculated Value
Live Stockpile Capacity	t	10,524,340	12629208	3	METS Assumption
Leach Extent Cu	%	TBD	TBD		
Leach Extent Mo	%	TBD	TBD		
Leach Extent Al	%	TBD	TBD		
Leach Extent Fe	%	TBD	TBD		
Leachant Discharge Rate	m <sup>3</sup> /h	5,096	6,116	2	METS Calculated Value
Heap Lift Height	m	10.00	12.00	3	METS Assumption
Heap Width	m	120.00	144.00	2	METS Calculated Value
Heap Length	m	500.00	600.00	2	METS Calculated Value
Heap Height	m	40.00	48.00	2	METS Calculated Value
Heap Evaporation Loss	%	2	2	3	METS Assumption
<b>Active Solution Pond (300-PD-03)</b>					
Volume/pad	m <sup>3</sup>	91,800	110,160	2	METS Calculated Value
Feed Rate (98% operating basis)	m <sup>3</sup> /h	5,096	6,116	2	METS Calculated Value
Solution pH	-	1.21	1.21	2	METS Calculated Value
Temperature	°C	40.00	40.00	3	METS Assumption
Loss From Evaporation	m <sup>3</sup> /h	6.12	7.34	2	METS Calculated Value
Discharge Rate (90% operating basis)	m <sup>3</sup> /h	3,865	4,638	2	METS Calculated Value
<b>ILS Pond (300-PD-02)</b>					
Volume/pad	m <sup>3</sup>	91,800	110,160	2	METS Calculated Value
Feed Rate	m <sup>3</sup> /h	5,096	6,116	2	METS Calculated Value
pH	-	TBD	TBD		
Temperature	°C	40	40	3	METS Assumption
Loss From Evaporation	m <sup>3</sup> /h	6.12	7.34	2	METS Calculated Value
Discharge Rate	m <sup>3</sup> /h	3,865	4,638	2	METS Calculated Value
<b>Barren Pond (300-PD-01)</b>					
Volume/pad	m <sup>3</sup>	91,800	110,160	2	METS Calculated Value
SX Return Feed Rate (90% operating basis)	m <sup>3</sup> /h	5,096	6,116	2	METS Calculated Value
Acid Addition (98% operating basis)	t/h	0.0	0.0	2	METS Calculated Value
Water Addition (98% operating basis)	t/h	0	0	2	METS Calculated Value
pH	-	1.27	1.27	2	METS Calculated Value
Temperature	°C	40	40	3	METS Assumption
Loss From Evaporation	m <sup>3</sup> /h	6.12	7.34	2	METS Calculated Value
Discharge Rate to Secondary Heap (98% operating basis)	m <sup>3</sup> /h	5,096	6,116	2	METS Calculated Value
<b>Piping and Materials</b>					
Pad Liner Material	-	1.5 mm HDPE with Thermal Welds		3	METS Assumption
Barren/ILS/PLS/Raffinate Return Piping	-	HDPE Piping		3	METS Assumption
<b>Area 400- Copper SX, Electrowinning and Crystallisation</b>					
<b>Circuit Configuration</b>					
Number of Trains	#	1.00	1.00	2	METS Calculated Value
Configuration	-	2E x 2 S	2E x 1SC x 1 S	2	METS Calculated Value
Contacting Units	-	mixer settlers, single distributor and 3 picket fences		3	METS Assumption
Availability	days	7,884	7,884	3	METS Assumption
<b>pH Adjustment Hopper (400-TK-01)</b>					
Feed	m <sup>3</sup> /h	3,865	4,638	2	METS Calculated Value
pH Feed	pH	1.21	1.45	2	METS Calculated Value
pH Discharge	pH	2	2	2	METS Calculated Value
Lime/Calcrete Added	t/h	5	6	2	METS Calculated Value
Residence Time	h	0.08	0.08	3	METS Assumption
Tank Capacity	m <sup>3</sup>	323	388	2	METS Calculated Value
<b>pH Adjustment Thickener (400-TH-01)</b>					
Type of Thickener	-	High Rate		3	METS Assumption
No. of Thickeners	#	1	1	3	METS Assumption
Feed Rate (Solids)	t/h	7	7.91	2	METS Calculated Value
Feed Rate (Slurry)	m <sup>3</sup> /h	3867	4,640	2	METS Calculated Value
Feed % Solids	w/w %	0.19	0.19	2	METS Calculated Value
Underflow % Solids	w/w %	50	50	3	METS Assumption
Underflow Solids Rate	dt/h	7	7.91	2	METS Calculated Value
Underflow Liquid	t/h	7	7.91	2	METS Calculated Value
Underflow Slurry Rate	t/h	13	15.82	2	METS Calculated Value
Underflow Slurry Rate	m <sup>3</sup> /h	9	10.73	2	METS Calculated Value
Underflow Density	t/m <sup>3</sup>	1.47	1.47	2	METS Calculated Value
Overflow % Solids	w/w %	0.00	0.00	3	METS Assumption
Overflow Solids Rate	dt/h	0.00	0.00	2	METS Calculated Value
Overflow Liquid	t/h	3858	4630	2	METS Calculated Value
Overflow Slurry Rate	t/h	3858	4630	2	METS Calculated Value
Overflow Slurry Rate	m <sup>3</sup> /h	3858	4630	2	METS Calculated Value
Overflow Density	t/m <sup>3</sup>	1.00	1.00	2	METS Calculated Value
Flocculant Dosage	g/t	100	100	3	METS Assumption

**J5329 - Deep-South - Haib Copper Project - Process Design Criteria**

Description	Units	Nominal	Design	Ref	Comments
Floc Rate	kg/h	0.66	0.79	2	METS Calculated Value
Settling Rate	m <sup>3</sup> /h/d	6.00	6.00	3	METS Assumption
Thickener Cross Sectional Area (Minimum)	m <sup>2</sup>	39.54	47.45	2	METS Calculated Value
Thickener Diameter (Minimum)	m	7	8.51	2	METS Calculated Value
Upflow Rate	m/h	97.57	117.08	2	METS Calculated Value
Residence time	h	TBD	TBD		
Thickener Volume	m <sup>3</sup>	TBD	TBD		
<b>pH Adjustment Filter Feed Tank (400-HP-01)</b>					
Residence Time	min	90	90	3	METS Assumption
Slurry Flow	m <sup>3</sup> /h	9	11	2	METS Calculated Value
Volume	m <sup>3</sup>	14	17	2	METS Calculated Value
<b>pH Adjustment Filter Press (400-FL-01/02)</b>					
Type	-	Pressure	Pressure	3	METS Assumption
Number of Filter Units	#	1	2	3	METS Assumption
Feed Rate (per Unit)	dt/h	7	8	2	METS Calculated Value
% Solids					
Feed	w/w %	50	50	3	METS Assumption
Cake	w/w %	5%	5%	3	METS Assumption
Filtration Rate	kg/m <sup>2</sup> /h	80	80	3	METS Assumption
Filter Area (per Unit)	m <sup>2</sup>	41	49	2	METS Calculated Value
Filter Cake Discharge (wet)	t/h	8	9	2	METS Calculated Value
Solids Discharge	dt/h	7	8	2	METS Calculated Value
Cake Moisture	t/h	1	1	2	METS Calculated Value
<b>SX Feed Polishing Filter (400-FL-03/04/05)</b>					
Type	-	Polishing	Polishing	3	METS Assumption
Number of Filter Units	#	4	4	3	METS Assumption
Feed Rate (per Unit)	m <sup>3</sup> /h	965	1,157	2	METS Calculated Value
Filter Area (per Unit)	m <sup>2</sup>	TBC	TBC		
Filter Cake Discharge (wet)	t/h	TBC	TBC		
Solids Discharge	dt/h	TBC	TBC		
Cake Moisture	t/h	TBC	TBC		
Filtrate	m <sup>3</sup> /h	3,858	4,630	2	METS Calculated Value
<b>SX PLS Feed Tank (400-TK-02)</b>					
Residence Time	min	10	10	3	METS Assumption
PLS Flowrate	m <sup>3</sup> /h	3,858	4,630	2	METS Calculated Value
Volume	m <sup>3</sup>	644	773	2	METS Calculated Value
<b>Copper Extraction Mixer Settler (400-SX-01/02)</b>					
Number of Cells	#	2	2	3	METS Assumption
Volume/Cell Minimum (Mixer)	m <sup>3</sup>	193	231	2	METS Calculated Value
Volume/Cell Minimum (Settler)	m <sup>3</sup>	1,029	1,235	2	METS Calculated Value
Residence Time (Mixer)	min	1.50	1.50	3	METS Assumption
Residence Time (Settler)	min	8.00	8.00	3	METS Assumption
Feed Rate	m <sup>3</sup> /h	3,858	4,630	2	METS Calculated Value
O/A Ratio		1:1	1:1	3	METS Assumption
Organic in Solvent	%	15	15	3	METS Assumption
Organic Feed Rate	m <sup>3</sup> /h	3,858	4,630	2	METS Calculated Value
LIX Loss Rate	m <sup>3</sup> /h	0.069	0.083	2	METS Calculated Value
Organic Makeup	m <sup>3</sup> /h	0.46	0.56	2	METS Calculated Value
Organic Diluent Loss Rate	m <sup>3</sup> /h	0.39	0.47	2	METS Calculated Value
Temperature	°C	Ambient	Ambient	3	METS Assumption
pH Initial		2.00	2.00	2	METS Calculated Value
Discharge Rate (Loaded Organic)	m <sup>3</sup> /h	3,858	4,630	2	METS Calculated Value
Organic Recovery	%	99.988%	99.988%	3	METS Assumption
Mixer Diameter		TBD	TBD		
Mixer Height		TBD	TBD		
Settler Width		TBD	TBD		
Settler Area Settler Length		TBD	TBD		
Copper Extraction	%	98%	98%	3	METS Assumption
Impurities Extraction	%	0%	0%	3	METS Assumption
<b>Loaded Organic Tank (400-TK-04)</b>					
Organic Feed	m <sup>3</sup> /h	3858	4630	2	METS Calculated Value
Residence Time	h	0.08	0.08	3	METS Assumption
Tank Capacity	m <sup>3</sup>	322	386	2	METS Calculated Value
<b>Copper Stripping Mixer Settler (400-SX-03/04)</b>					
Number of Cells	#	2	2	3	METS Assumption
Volume/Cell Minimum (Mixer)	m <sup>3</sup>	102	123	2	METS Calculated Value
Volume/Cell Minimum (Settler)	m <sup>3</sup>	545	654	2	METS Calculated Value
Residence Time (Mixer)	min	1.50	1.50	3	METS Assumption
Residence Time (Settler)	min	8.00	8.00	3	METS Assumption
Organic Feed Rate	m <sup>3</sup> /h	3,858	4,630	2	METS Calculated Value
O/A		16:1	16:1	3	METS Assumption
Stripping Solution Feed Rate	m <sup>3</sup> /h	227.3	272.8	3	METS Assumption
Temperature	°C	Ambient	Ambient	3	METS Assumption
Organic Discharge Rate	m <sup>3</sup> /h	3,858	4,630	2	METS Calculated Value
Aqueous Discharge Rate	m <sup>3</sup> /h	227.3	272.8	2	METS Calculated Value
H <sub>2</sub> SO <sub>4</sub> Concentration	g/L	200.00	200.00	3	METS Assumption
H <sub>2</sub> SO <sub>4</sub> (100%) Required	t/h	45.5	45.5	2	METS Calculated Value



**J5329 - Deep-South - Haib Copper Project - Process Design Criteria**

Description	Units	Nominal	Design	Ref	Comments
H <sub>2</sub> SO <sub>4</sub> (100%) Recycled	t/h	0.0	0.0	2	METS Calculated Value
H <sub>2</sub> SO <sub>4</sub> (100%) Makeup	t/h	4.6	5.6	2	METS Calculated Value
Temperature	°C	Ambient	Ambient	3	METS Assumption
pH		-0.61	-0.61	2	METS Calculated Value
Split to Electrowinning	%	100	100	3	METS Assumption
Stripping Efficiency	%	100	100	3	METS Assumption
<b>Organic Control Tank (400-TK-03)</b>					
Organic Feed	m <sup>3</sup> /h	3858	4630	2	METS Calculated Value
Residence Time	h	0.08	0.08	3	METS Assumption
Tank Capacity	m <sup>3</sup>	322	386	2	METS Calculated Value
<b>Stripping Liquor Makeup Tank (400-TK-05)</b>					
Feed	m <sup>3</sup> /h	227.3	272.8	2	METS Calculated Value
Residence Time	h	0.08	0.08	3	METS Assumption
Tank Capacity	m <sup>3</sup>	19	23	2	METS Calculated Value
<b>Copper Electrowinning Cells (400-EC-01---188)</b>					
Number of Cells	#	188	188	3	METS Assumption
Electrowin Time	days	TBD	1.00		
Cell Volume	m <sup>3</sup>	TBD	519.6		
Flowrate	m <sup>3</sup> /h	0.9	1.1	2	METS Calculated Value
Current Density	A/m <sup>2</sup>	282.0	282.0	3	METS Assumption
Cell Voltage	V	2.0	2.0	3	METS Assumption
Cathode Material	-	Stainless Steel Blank Cathodes		3	METS Assumption
Cathode Cleaning	-	High Pressure Water		3	METS Assumption
Cathode Cleaning Frequency	per week	1.0	1.0	3	METS Assumption
Water Requirement for Cathode Cleaning	m <sup>3</sup> /clean	15.0	18.0	3	METS Assumption
Electrowinning Efficiency	%	100		3	METS Assumption
<b>Copper Sulphate Crystalliser Package (400-PK-01)</b>					
Number of Units	#	1	1	3	METS Assumption
Type	-	Evaporative		3	METS Assumption
Feed Rate	m <sup>3</sup> /h	58.1	69.8	2	METS Calculated Value
Residence Time	h	1	1.0	3	METS Assumption
Temperature	°C	TBD	TBD		
Crystallisation Rate	t/h	TBD	TBD		
Slurry Discharge Rate	t/h	16	19.0	2	METS Calculated Value
Solids %	%	40%	40%	3	METS Assumption
Crystallisation Efficiency	%	100	100.0	3	METS Assumption
<b>Centrifuge</b>					
Type	-	Screen Scroll Centrifuge		3	METS Assumption
Capacity	-	TBD	TBD		
Feed Rate	t/h	15.9	19.0	2	METS Calculated Value
Feed Solids %	%	40%	40%	3	METS Assumption
Discharge Rate	t/h	6.9	8.3	2	METS Calculated Value
Discharge Solids %	%	92%	92%	3	METS Assumption
<b>Flash Drying Circuit Package (400-PK-02)</b>					
Type	-	Flash Dryer			
Feed Rate	t/h	6.9	8.3	2	METS Calculated Value
Residence Time	h	TBD	TBD		
Temperature	°C	TBD	TBD		
Product Discharge Rate	t/h	6.3	7.6	2	METS Calculated Value
Product Solids %	%	98%	98%	3	METS Assumption

**J5329 - Deep-South - Haib Copper Project - Process Design Criteria**

Description	Units	Nominal	Design	Ref	Comments
<b>Area 500 - Iron Precipitation</b>					
<b>Iron Precipitation Tank (500-TK-01)</b>					
Number of Tanks	#	1.0		3	METS Assumption
pH		5.8		3	METS Assumption
Temperature	°C	40		3	METS Assumption
Feed Rate	t/h	1,543		2	METS Calculated Value
Lime Addition Rate	dt/h	1.8	2.2	2	METS Calculated Value
Lime Density	t/m <sup>3</sup>	1.2	1.2	3	METS Assumption
Limestone/Calcrete	dt/h	3.3	3.9	2	METS Calculated Value
Residence Time	h	0.2	0.2	2	METS Calculated Value
Discharge Rate	t/h	1,551	1,550.6	2	METS Calculated Value
Capacity	m <sup>3</sup>	259	310.8	3	METS Assumption
<b>Iron Precipitate Thickener (500-TH-01)</b>					
Type of Thickener	-	High Rate		3	METS Assumption
No. of Thickeners	#	1	1.00	3	METS Assumption
Feed Rate (Solids)	dt/h	154	184.23	2	METS Calculated Value
Feed Rate (Slurry)	m <sup>3</sup> /h	1425	1,709.76	2	METS Calculated Value
Feed % Solids	w/w %	10.1	10.1	2	METS Calculated Value
Underflow % Solids	w/w %	50	50	3	METS Assumption
Underflow Solid Rate	dt/h	154	184.23	2	METS Calculated Value
Underflow Liquid	t/h	154	184.23	2	METS Calculated Value
Underflow Slurry Rate	t/h	307	368.47	2	METS Calculated Value
Underflow Slurry Rate	m <sup>3</sup> /h	208	250.03	2	METS Calculated Value
Underflow Density	t/m <sup>3</sup>	1.47	1.47	2	METS Calculated Value
Overflow % Solids	w/w %	0.00	0.00	3	METS Assumption
Overflow Solid Rate	dt/h	0.00	0.00	2	METS Calculated Value
Overflow Liquid	t/h	1,244	1,492.24	3	METS Assumption
Overflow Slurry Rate	t/h	1,244	1,492.24	2	METS Calculated Value
Overflow Slurry Rate	m <sup>3</sup> /h	1,244	1,492.24	2	METS Calculated Value
Overflow Density	t/m <sup>3</sup>	1.00	1.00	3	METS Assumption
Flocculant Dosage	g/t	100	100	3	METS Assumption
Floc Rate	kg/h	15.35	18.42	2	METS Calculated Value
Settling Rate	m <sup>2</sup> /d	8.00	8.00	3	METS Assumption
Thickener Cross Sectional Area (Minimum)	m <sup>2</sup>	921	1,105.40	2	METS Calculated Value
Thickener Diameter (Minimum)	m	34	41.10	2	METS Calculated Value
Upflow Rate	m/h	1.35	1.62	2	METS Calculated Value
Residence Time	h	TBD	TBD		
Thickener Volume	m <sup>3</sup>	TBD	TBD		
<b>Iron Tailings Filter Feed Tank (500-TK-02)</b>					
Residence Time	min	30	30	3	METS Assumption
Slurry Flow	m <sup>3</sup> /h	208	250	2	METS Calculated Value
Volume	m <sup>3</sup>	105	126	2	METS Calculated Value
<b>Iron Tailings Filter Press (500-FL-01/02)</b>					
Type	-	Pressure	TBD	3	METS Assumption
Number of Filter Units	#	2.00	2.00	3	METS Assumption
Feed Rate	(per Unit) dt/h	76.8	92.12	2	METS Calculated Value
% Solids					
Feed	w/w %	50	50	3	METS Assumption
Cake	w/w %	10	10	3	METS Assumption
Filtration Rate	kg/m <sup>2</sup> /h	80.00	80	3	METS Assumption
Filter Area	(per Unit) m <sup>2</sup>	480	575.7	2	METS Calculated Value
Filter Cake Discharge	wet t/h	180.6	216.7	2	METS Calculated Value
Solids Discharge	dt/h	153.5	184.2	2	METS Calculated Value
Cake Moisture	t/h	27.09	32.5	2	METS Calculated Value
<b>Raffinate Recycle Tank (500-TK-03)</b>					
Residence Time	minutes	5	5	3	METS Assumption
Flow from Filtrate	m <sup>3</sup> /h	181	217	2	METS Calculated Value
Flow From Thickener	m <sup>3</sup> /h	1,244	1,492	2	METS Calculated Value
Flow rate (Total)	m <sup>3</sup> /h	1,424	1,709	2	METS Calculated Value
Volume	m <sup>3</sup>	119	143	2	METS Calculated Value
<b>Area 600 - Process and Raw Water</b>					
<b>Raw Water Dam (600-DM-01/02)</b>					
Raw Water Requirement	m <sup>3</sup> /h	302	362	2	METS Calculated Value
Raw Water Requirement	m <sup>3</sup> /d	7,250	8,699	2	METS Calculated Value
Residence Time	d	5	5	3	METS Assumption
Storage Capacity	m <sup>3</sup>	36,300	43,560	2	METS Calculated Value
<b>Raw Water Tank (600-TK-02)</b>					
Raw Water Requirement	m <sup>3</sup> /h	302	362	2	METS Calculated Value
Raw Water Requirement	m <sup>3</sup> /d	7,250	8,699	2	METS Calculated Value
Residence Time	d	1	1	3	METS Assumption
Storage Capacity	m <sup>3</sup>	7,900	8,760	2	METS Calculated Value
<b>Process Water Tank (600-TK-01/03)</b>					
Process Water Drawdown	m <sup>3</sup> /h	60	72	3	METS Assumption
Raw Water Requirement	m <sup>3</sup> /h	15	18	3	METS Assumption
Residence Time	d	1	1	3	METS Assumption



**Client** Deep-South Resources  
**Project** Haib Copper Project  
**Job #** J5329  
**Doc #** J5329-P-PDC-000-001  
**Doc Title** Process Design Criteria 20 Mtpa @ 85% Cu Recovery+CuSO4  
**Rev** A

**J5329 - Deep-South - Haib Copper Project - Process Design Criteria**

Description	Units	Nominal	Design	Ref	Comments
Storage Capacity	m <sup>3</sup>	1500	1,800	2	METS Calculated Value
<b>Raw Water</b>					
Supply Source		Orange River			
<b>Analysis</b>					
pH		TBD			
E Coli		TBD			
Copper	ppm	TBD			
Iron	ppm	TBD			
Cobalt	ppm	TBD			
Nickel	ppm	TBD			
TSS	ppm	TBD			

**J5329 - Deep-South - Haib Copper Project - Process Design Criteria**

Description	Units	Nominal	Design	Ref	Comments
TDS	ppm	TBD			
Total Sulphate	ppm	TBD			
<b>Potable Water Quality</b>					
pH	-	6.5-8	8.00		
Conductivity	µS/cm	TBD	5.80		
Total Dissolved Solids	mg/l	TBD	500		
Total Hardness as CaCO <sub>3</sub>	mg/l	TBD	200		
Na <sup>+</sup>	mg/l	TBD	180		
Cl <sup>-</sup>	mg/l	TBD	250		
Ca <sup>2+</sup>	mg/l	TBD	5.00		
SO <sub>4</sub> <sup>2-</sup>	mg/l	TBD	250		
<b>Area 700- Reagents</b>					
<b>LIX-984N</b>					
Supply Method	-	Bulk		3	METS Assumption
Supply Form	-	Liquid		3	METS Assumption
Supply Bulk Density	t/m <sup>3</sup>	0.88		4	Market Specification
Storage Tank Residence Time	h	48	48.00	3	METS Assumption
Storage Tank Capacity	m <sup>3</sup>	4.00	9.60	2	METS Calculated Value
Mixing Tank Capacity	m <sup>3</sup>	3.00	7.20	2	METS Calculated Value
Mixing Tank Residence Time	h	5	5.00	3	METS Assumption
O in Solvent	%w/w	15	15	3	METS Assumption
Addition	m <sup>3</sup> /h	0.07	0.07	2	METS Calculated Value
Raw Diluent for Mixing	m <sup>3</sup> /h	0.39	0.39	2	METS Calculated Value
<b>Kerosene</b>					
Supply Method	-	Bulk		3	METS Assumption
Supply Form	-	Liquid		3	METS Assumption
Supply Bulk Density	t/m <sup>3</sup>	0.81		3	METS Assumption
Kerosene Process Feed	m <sup>3</sup> /h	0.39	0.47	2	METS Calculated Value
Storage Residence Time	h	24	24	3	METS Assumption
Storage Tank Capacity	m <sup>3</sup>	10.00	12.00	2	METS Calculated Value
<b>Quicklime</b>					
Supply Method	-	Bulk		3	METS Assumption
Supply Form	-	Solid		3	METS Assumption
Supply Density	t/m <sup>3</sup>	3.35		7	Other Sources
Supply Bulk Density	t/m <sup>3</sup>	0.88		7	Other Sources
Storage Residence Time	h	24		3	METS Assumption
Process Lime Requirement	t/h	1.83	2.19	2	METS Calculated Value
Raw Water for Mixing	m <sup>3</sup> /h	5.49	6.58	2	METS Calculated Value
Storage Silo Volume	m <sup>3</sup>	50	60	2	METS Calculated Value
Distribution Tank Residence Time	h	1	1	3	METS Assumption
Distribution Tank Volume	m <sup>3</sup>	7.00	8.40	2	METS Calculated Value
% Solids	%w/w	25%	25%	3	METS Assumption
<b>Limestone/Cicrete</b>					
Supply Method	-	Bulk		3	METS Assumption
Supply Form	-	Solid		3	METS Assumption
Supply Density	t/m <sup>3</sup>	2.60		7	Other Sources
Storage Residence Time	h	24		3	METS Assumption
Process Requirement	t/h	8.11	9.73	2	METS Calculated Value
Raw Water for Mixing	m <sup>3</sup> /h	24.33	29.19	2	METS Calculated Value
Storage Silo Volume	m <sup>3</sup>	75	90	2	METS Calculated Value
Distribution Tank Residence Time	h	1	1	3	METS Assumption
Distribution Tank Volume	m <sup>3</sup>	28.00	33.60	2	METS Calculated Value
% Solids	%w/w	25%	25%	3	METS Assumption
<b>Sulphuric Acid</b>					
Supply Method	-	Bulk Bag		3	METS Assumption
Supply Form	-	S. Powder		3	METS Assumption
H <sub>2</sub> SO <sub>4</sub> Density	t/m <sup>3</sup>	1.84		3	METS Assumption
H <sub>2</sub> SO <sub>4</sub> Process Requirement	t/h	4.87		2	METS Calculated Value
H <sub>2</sub> SO <sub>4</sub> Process Requirement	m <sup>3</sup> /h	2.65	3.17	2	METS Calculated Value
H <sub>2</sub> SO <sub>4</sub> Storage Residence Time	h	24	24	3	METS Assumption
H <sub>2</sub> SO <sub>4</sub> Storage Tank Capacity	m <sup>3</sup>	64	76.80	2	METS Calculated Value
<b>Binder</b>					
Supply Method	-	Bulk Bag		3	METS Assumption
Supply Form	-	Solid		3	METS Assumption
Supply Bulk Density	t/m <sup>3</sup>	1.00		3	METS Assumption
Storage Residence Time	h	12		3	METS Assumption
Binder Consumption	kg/t	0.50	0.50	3	METS Assumption
Process Requirement	t/h	0.4	0.44	2	METS Calculated Value
Binder Feed Hopper Capacity	m <sup>3</sup>	5.0	6.00	2	METS Calculated Value
<b>Flocculant</b>					
Type	-	Magnafloc 155		3	METS Assumption
Supply Method	-	25 kg Bags		3	METS Assumption
Supply Form	-	Solid		3	METS Assumption
Flocculant Mixing Tank Residence Time	h	2		3	METS Assumption
Flocculant Storage Tank Residence Time	h	24		3	METS Assumption
Flocculant Mixing Tank Capacity	L	10		2	METS Calculated Value



**Client** Deep-South Resources  
**Project** Haib Copper Project  
**Job #** J5329  
**Doc #** J5329-P-PDC-000-001  
**Doc Title** Process Design Criteria 20 Mtpa @ 85% Cu Recovery+CuSO4  
**Rev** A

**J5329 - Deep-South - Haib Copper Project - Process Design Criteria**

Description	Units	Nominal	Design	Ref	Comments
Flocculant Storage Tank Capacity	m <sup>3</sup>	1		2	METS Calculated Value
Bulk Density	t/m <sup>3</sup>	0.75		7	Other Sources
Total Addition Rate	kg/h	16.01	19.21	3	METS Assumption
Addition Concentration	%w/v	25	25	3	METS Assumption
Inline Mixer Dilution	%w/v	2.5	2.5	3	METS Assumption
Viscosity (After dilution)	cP	300	300	3	METS Assumption
Addition Concentration (Belt Filter)	%w/v	25	25	3	METS Assumption
Raw Water for Mixing	m <sup>3</sup> /h	0.000854	0.001025	2	METS Calculated Value
<b>Area 800- Services</b>					
<b>Air Compressor</b>					
HP Air Compressor Type	-		Screw	3	METS Assumption
HP Air Pressure	kPa	750		3	METS Assumption
HP Air Compressor Capacity	Nm <sup>3</sup> /h	250	300	3	METS Assumption
<b>Plant Air Filter</b>					
Type					
<b>Plant Air Receiver</b>					
Type	-	Standard Receiver Vessel		3	METS Assumption
HP Air Receiver Volume	L			3	METS Assumption
<b>Instrument Air</b>					
Instrument Air Pressure	kPa	750		3	METS Assumption
HP Air Compressor Capacity	m <sup>3</sup> /h				



© THIS DRAWING IS THE PROPERTY OF M.E.T.S. P/L AND SHALL NOT BE USED OR REPRODUCED WITHOUT THE EXPRESS WRITTEN CONSENT OF THE CORPORATION

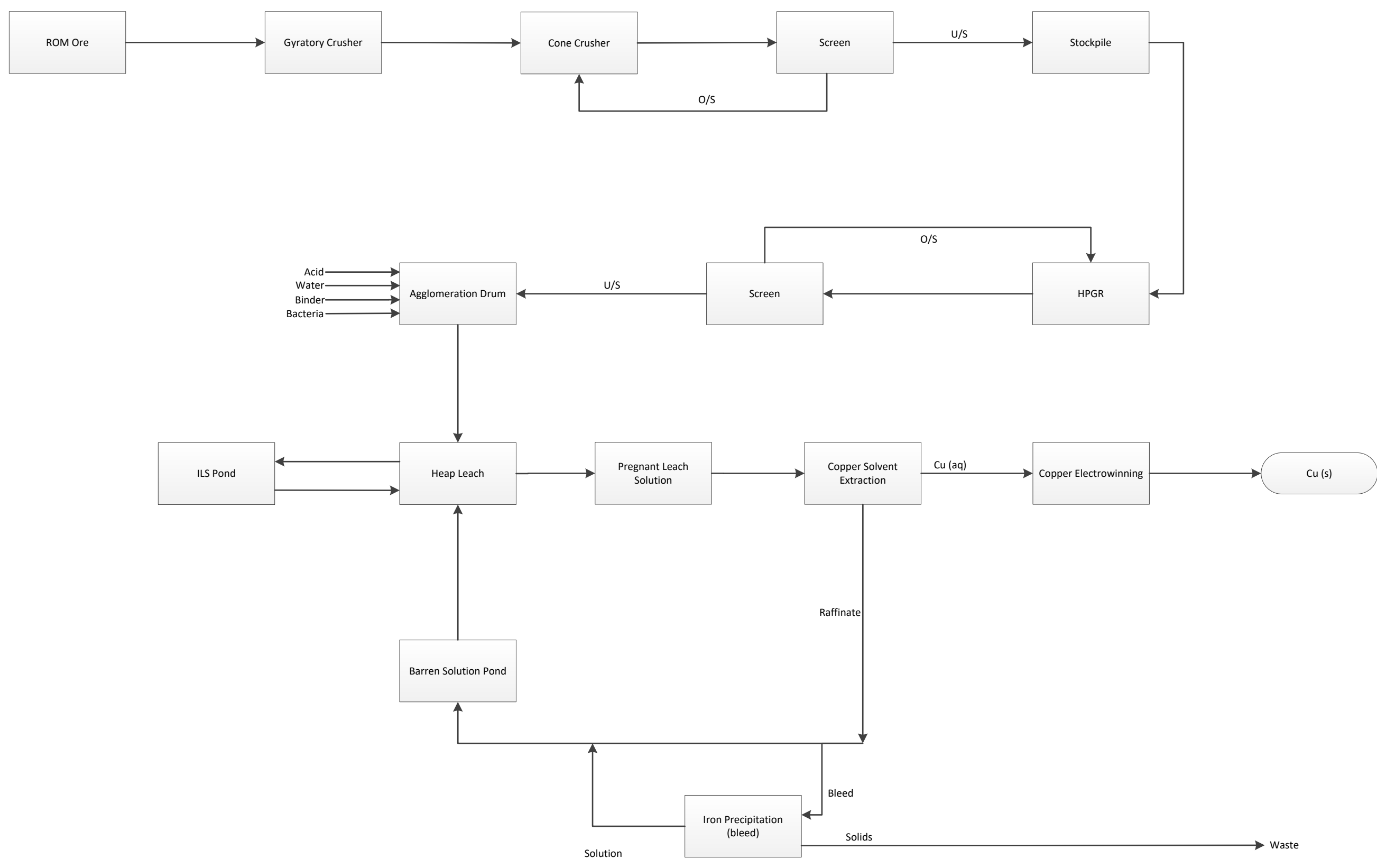

FOR INFORMATION ONLY  
NOT FOR CONSTRUCTION

REV	DATE	REVISION DETAIL	DRN	CHKD	APPV	REV	DATE	DRAWING NUMBER	REFERENCE DRAWING TITLE
A	07/01/2020	Issued for Internal Review	KM						

**METS ENGINEERING**  
PROCESS + INNOVATION

Resource Projects · Technology  
Integrated Services  
L3, 44 Parliament Place, West Perth 6005  
PO BOX 1699, West Perth 6872

CLIENT: **DEEP SOUTH Resources Inc.**

PROJECT: **Haib Heap Leach Project**

DRAWN	SIGNED	DATE
KM		07/01
CHECKED	SIGNED	DATE
DESIGNED	SIGNED	DATE
VERIFIED	SIGNED	DATE
CLIENT APP.	SIGNED	DATE

TITLE: **Block Flow Diagram Whole Ore Heap Leach**

Eq. No.:  
AREA:  
SHEET 1 OF 1

DRAWING NO. **J5329-P-BFD-000-001**

DO NOT SCALE

WEIGHT	SCALE	SHEET
~ KG	1:1	A3
AREA No.	PROJECT No.	REV
		A

1 2 3 4 5 6

A

B

C

D

E

F

A

B

C

D

E

F

6

© THIS DRAWING IS THE PROPERTY OF M.E.T.S. P/L AND SHALL NOT BE USED OR REPRODUCED WITHOUT THE EXPRESS WRITTEN CONSENT OF THE CORPORATION

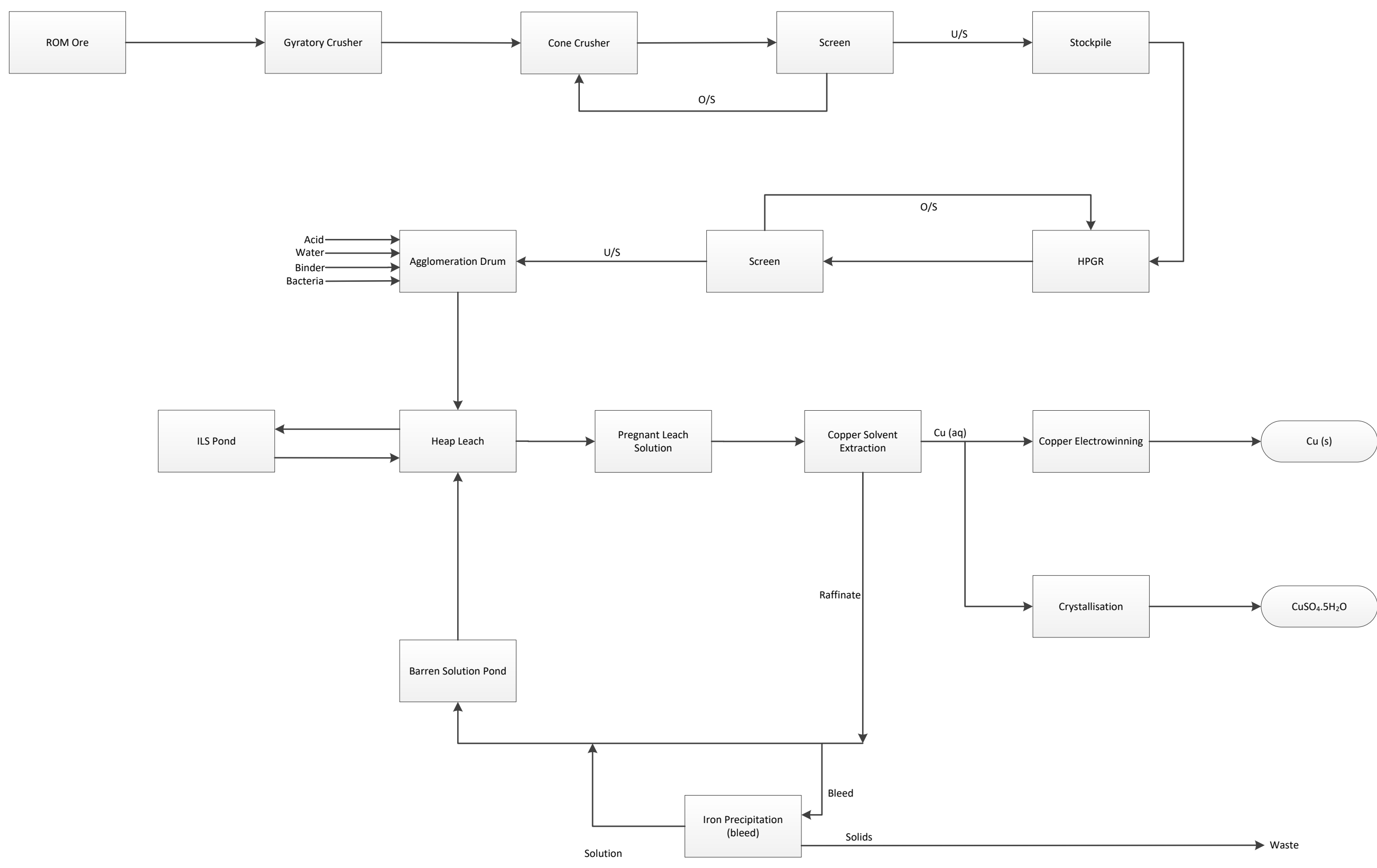

FOR INFORMATION ONLY  
NOT FOR CONSTRUCTION

REV	DATE	REVISION DETAIL	DRN	CHKD	APPV	REV	DATE	DRAWING NUMBER	REFERENCE DRAWING TITLE
A	07/01/2020	Issued for Internal Review	KM						

**METS ENGINEERING**  
PROCESS + INNOVATION

Resource Projects · Technology  
Integrated Services  
L3, 44 Parliament Place, West Perth 6005  
PO BOX 1699, West Perth 6872

CLIENT: **DEEP SOUTH Resources Inc.**

PROJECT: **Haib Heap Leach Project**

DRAWN	SIGNED	DATE
KM		07/01
CHECKED	SIGNED	DATE
DESIGNED	SIGNED	DATE
VERIFIED	SIGNED	DATE
CLIENT APP.	SIGNED	DATE

TITLE: **Block Flow Diagram Whole Ore Heap Leach + CuSO4**

Eq. No.:  
AREA:  
SHEET 1 OF 1

DRAWING NO. **J5329-P-BFD-000-001**

DO NOT SCALE

WEIGHT ~ KG	SCALE 1:1	SHEET A3
AREA No.	PROJECT No.	REV A

1 2 3 4 5 6

A

A

B

B

C

C

D

D

E

E

F

F

1 2 3 4 5 6



© THIS DRAWING IS THE PROPERTY OF M.E.T.S. P/L AND SHALL NOT BE USED OR REPRODUCED WITHOUT THE EXPRESS WRITTEN CONSENT OF THE CORPORATION

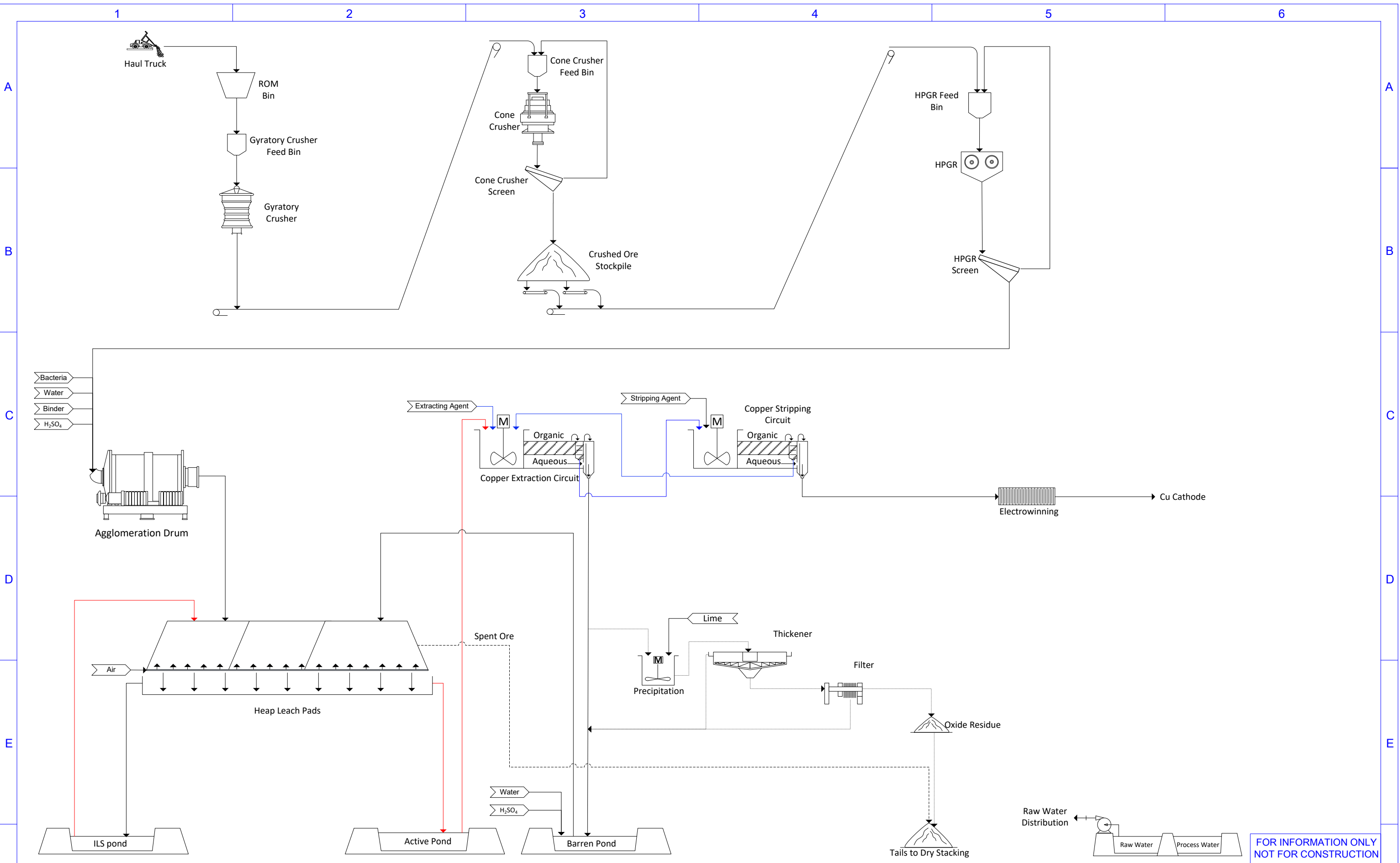

REV	DATE	REVISION DETAIL	DRN	CHKD	APPV	REV	DATE	DRAWING NUMBER	REFERENCE DRAWING TITLE
A	07/01/2020	General Revision	KM						

**METS ENGINEERING**  
PROCESS + INNOVATION

Resource Projects · Technology  
Integrated Services

L3, 44 Parliament Place, West Perth 6005  
PO BOX 1699, West Perth 6872

CLIENT: **DEEP SOUTH Resources Inc.**

PROJECT: **Haib Heap Leach Project**

DRAWN	SIGNED	DATE
KM		07/01
CHECKED	SIGNED	DATE
DESIGNED	SIGNED	DATE
VERIFIED	SIGNED	DATE
CLIENT APP.	SIGNED	DATE

TITLE: **Overall Process Flow Diagram  
Whole Ore Heap Leach**

Eq. No.:  
AREA:  
SHEET 1 OF 1

DRAWING NO. **J5329-P-PFD-001**

DO NOT SCALE

WEIGHT ~ KG	SCALE 1:1	SHEET A3
AREA No.	PROJECT No.	REV A

© THIS DRAWING IS THE PROPERTY OF M.E.T.S. P/L AND SHALL NOT BE USED OR REPRODUCED WITHOUT THE EXPRESS WRITTEN CONSENT OF THE CORPORATION

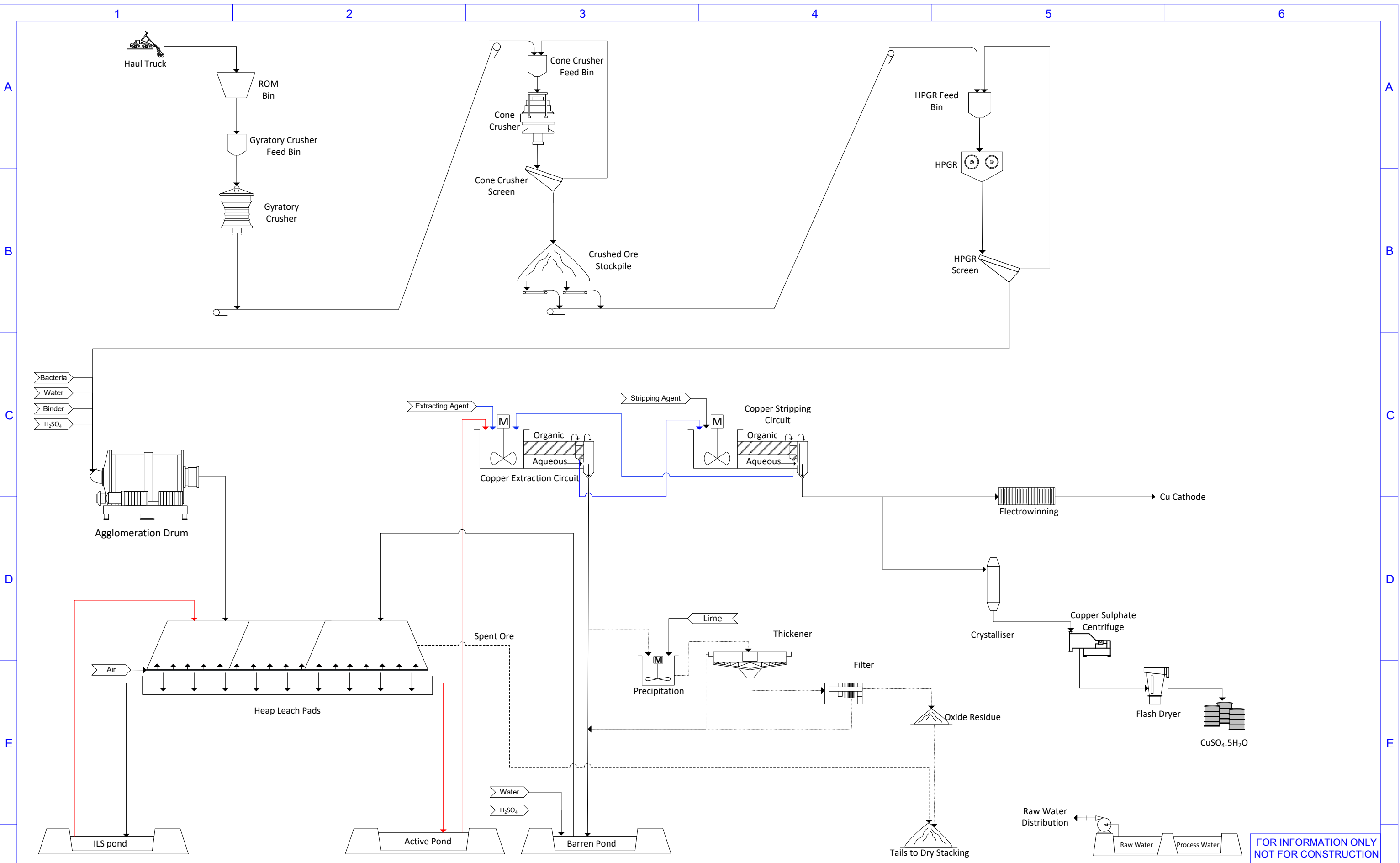

REV	DATE	REVISION DETAIL	DRN	CHKD	APPV	REV	DATE	DRAWING NUMBER	REFERENCE DRAWING TITLE
A	07/01/2020	General Revision	KM						

**METS ENGINEERING**  
PROCESS + INNOVATION

Resource Projects · Technology  
Integrated Services

L3, 44 Parliament Place, West Perth 6005  
PO BOX 1699, West Perth 6872

CLIENT: **DEEP SOUTH Resources Inc.**

PROJECT: **Haib Heap Leach Project**

DRAWN	SIGNED	DATE
KM		07/01
CHECKED	SIGNED	DATE
DESIGNED	SIGNED	DATE
VERIFIED	SIGNED	DATE
CLIENT APP.	SIGNED	DATE

TITLE: **Overall Process Flow Diagram  
Whole Ore Heap Leach + CuSO4**

Eq. No.:  
AREA:  
SHEET 1 OF 1

DRAWING NO. **J5329-P-PFD-001**

DO NOT SCALE

WEIGHT ~ KG	SCALE 1:1	SHEET A3
AREA No.	PROJECT No.	REV A

FOR INFORMATION ONLY  
NOT FOR CONSTRUCTION

© THIS DRAWING IS THE PROPERTY OF M.E.T.S. P/L AND SHALL NOT BE USED OR REPRODUCED WITHOUT THE EXPRESS WRITTEN CONSENT OF THE CORPORATION

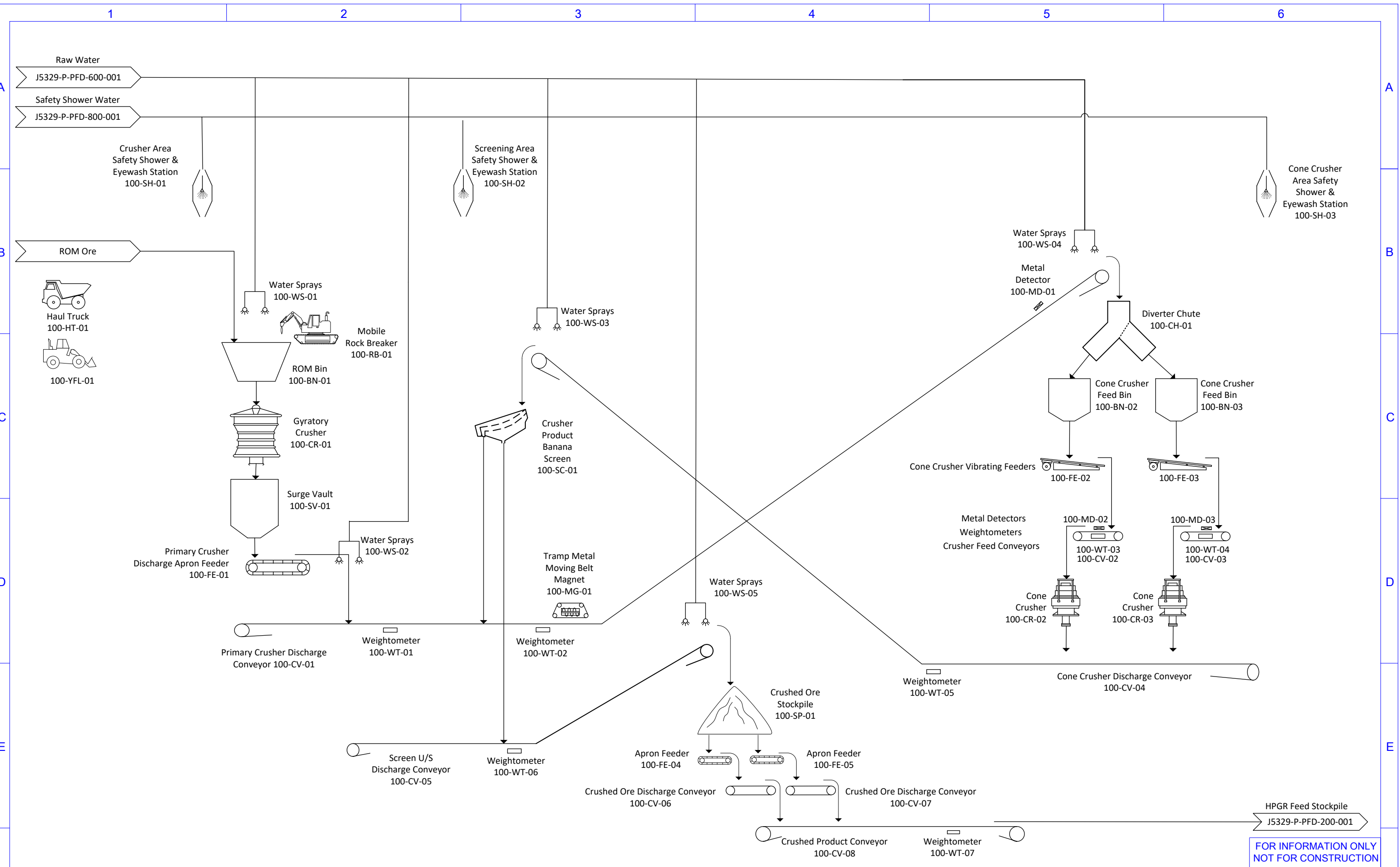

FOR INFORMATION ONLY  
NOT FOR CONSTRUCTION

REV	DATE	REVISION DETAIL	DRN	CHKD	APPV	REV	DATE	DRAWING NUMBER	REFERENCE DRAWING TITLE
C	17/02/2020	Updated after Internal Review	LZ	BM			17/02/2020		
B	23/01/2020	Updated after Internal Review	ZT	BM			17/02/2020		
A	07/01/2020	Issued for Internal Review	KM	BM			22/01/2020		

**METS ENGINEERING**  
PROCESS + INNOVATION

Resource Projects · Technology  
Integrated Services

L3, 44 Parliament Place, West Perth 6005  
PO BOX 1699, West Perth 6872

CLIENT: **DEEP SOUTH Resources Inc.**

PROJECT: **Haib Heap Leach Project**

DRAWN	SIGNED	DATE	TITLE:
KM		07/01	<b>8.5 Mtpa Crushing</b>
CHECKED	SIGNED	DATE	
DESIGNED	SIGNED	DATE	
VERIFIED	SIGNED	DATE	
CLIENT APP.	SIGNED	DATE	Eq. No.: AREA:100 SHEET 1 OF 1 DRAWING NO. <b>J5329-P-PFD-100-001</b>

DO NOT SCALE		
WEIGHT ~ KG	SCALE 1:1	SHEET A3
AREA No.	PROJECT No.	REV C

F  
E  
D  
C  
B  
A

© THIS DRAWING IS THE PROPERTY OF M.E.T.S. P/L AND SHALL NOT BE USED OR REPRODUCED WITHOUT THE EXPRESS WRITTEN CONSENT OF THE CORPORATION

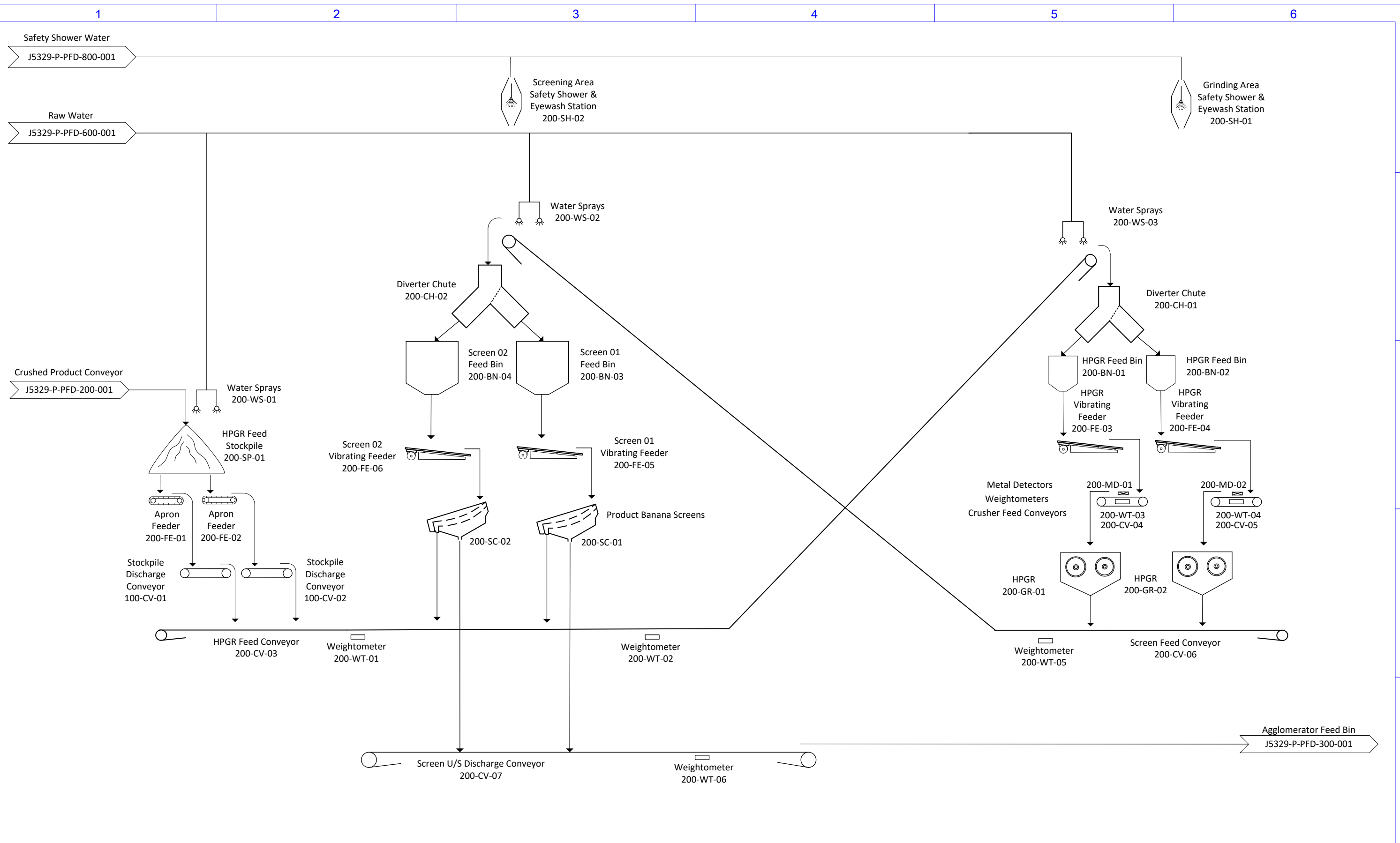

FOR INFORMATION ONLY  
NOT FOR CONSTRUCTION

REV	DATE	REVISION DETAIL	DRN	CHKD	APPV	REV	DATE	DRAWING NUMBER	REFERENCE DRAWING TITLE
C	17/02/2020	Updated after Internal Review	LZ	BM			17/02/2020		
B	23/01/2020	Updated after Internal Review	ZT	BM			17/02/2020		
A	07/01/2020	Issued for Internal Review	KM	BM			22/01/2020		

**METS ENGINEERING**  
PROCESS + INNOVATION

Resource Projects · Technology  
Integrated Services

L3, 44 Parliament Place, West Perth 6005  
PO BOX 1699, West Perth 6872

CLIENT: **DEEP SOUTH Resources Inc.**

PROJECT: **Haib Heap Leach Project**

DRAWN	SIGNED	DATE
KM		07/01
CHECKED	SIGNED	DATE
DESIGNED	SIGNED	DATE
VERIFIED	SIGNED	DATE
CLIENT APP.	SIGNED	DATE

TITLE: **8.5 Mtpa High Pressure Grinding Rolls (HPGR)**

Eq. No.:  
AREA:200  
SHEET 1 OF 1

DRAWING NO. **J5329-P-PFD-200-001**

DO NOT SCALE

WEIGHT	SCALE	SHEET
~ KG	1:1	A3

AREA No. PROJECT No. REV C

© THIS DRAWING IS THE PROPERTY OF M.E.T.S. P/L AND SHALL NOT BE USED OR REPRODUCED WITHOUT THE EXPRESS WRITTEN CONSENT OF THE CORPORATION

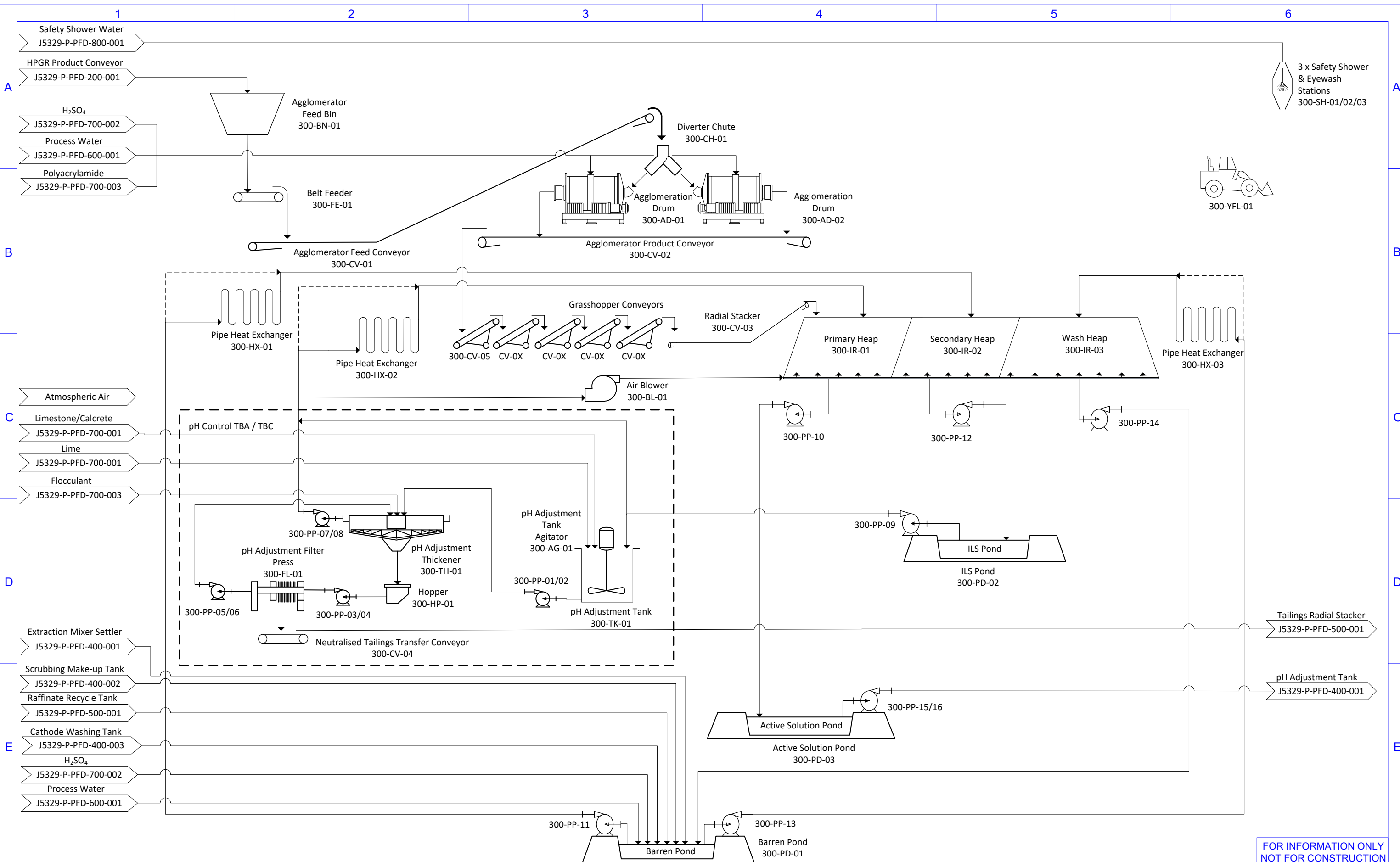

FOR INFORMATION ONLY  
NOT FOR CONSTRUCTION

REV	DATE	REVISION DETAIL	DRN	CHKD	APPV	REV	DATE	DRAWING NUMBER	REFERENCE DRAWING TITLE
C	17/02/2020	Updated after Internal Review	LZ	BM			17/02/2020		
B	23/01/2020	Updated After Internal Review	ZT	BM			17/02/2020		
A	07/01/2020	Issued for Internal Review	KM	BM			22/01/2020		

**METS ENGINEERING**  
PROCESS + INNOVATION

Resource Projects · Technology  
Integrated Services

L3, 44 Parliament Place, West Perth 6005  
PO BOX 1699, West Perth 6872

CLIENT: **DEEP SOUTH Resources Inc.**

PROJECT: **Haib Heap Leach Project**

DRAWN	SIGNED	DATE	TITLE:
KM		07/01	<b>8.5Mtpa Agglomeration and Heap Leach</b> Eq. No.: AREA:300 SHEET 1 OF 1 DRAWING NO. J5329-P-PFD-300-001
CHECKED	SIGNED	DATE	
DESIGNED	SIGNED	DATE	
VERIFIED	SIGNED	DATE	
CLIENT APP.	SIGNED	DATE	

DO NOT SCALE	
WEIGHT ~ KG	SCALE 1:1
SHEET A3	REV C

© THIS DRAWING IS THE PROPERTY OF M.E.T.S. P/L AND SHALL NOT BE USED OR REPRODUCED WITHOUT THE EXPRESS WRITTEN CONSENT OF THE CORPORATION

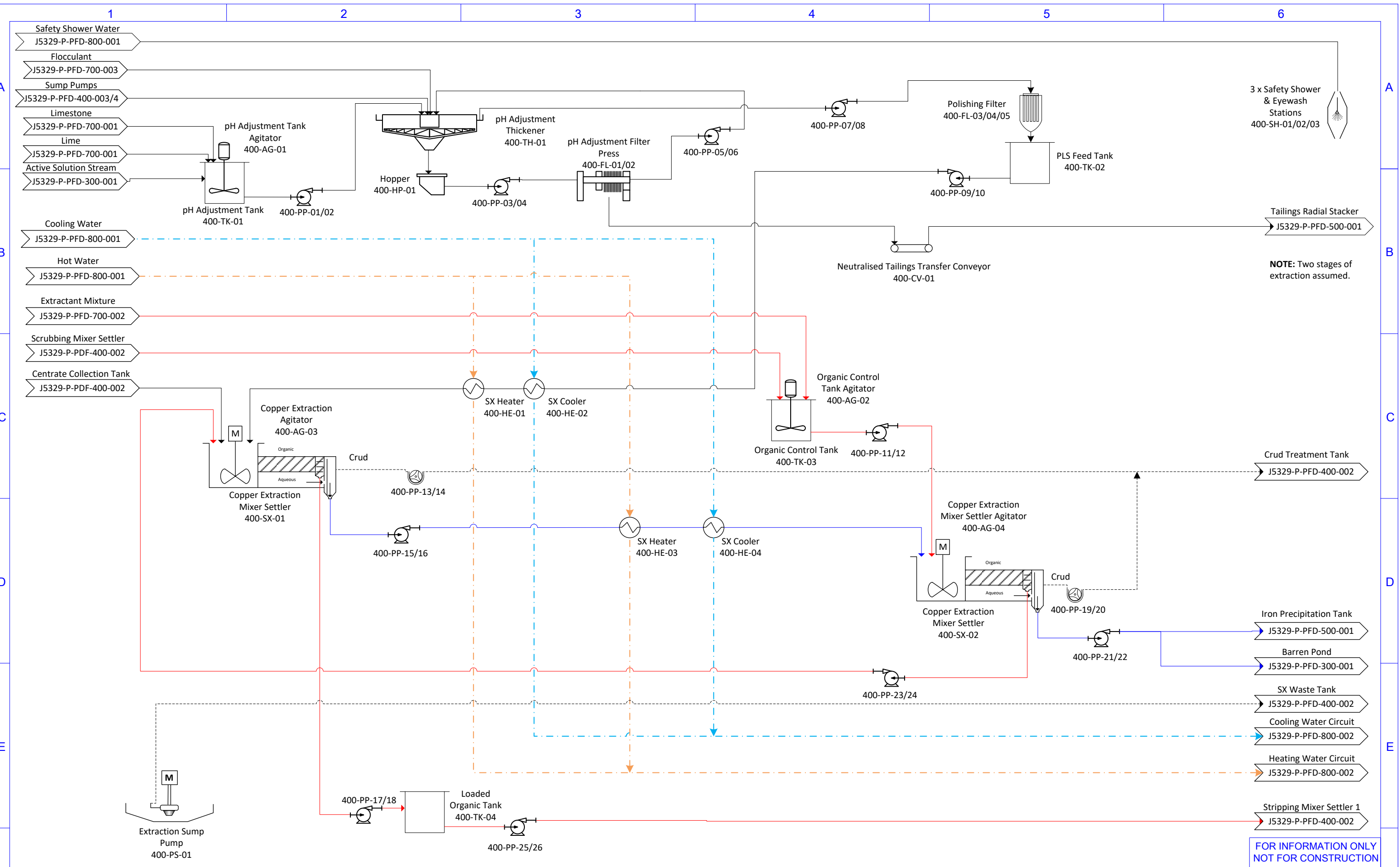

FOR INFORMATION ONLY  
NOT FOR CONSTRUCTION

REV	DATE	REVISION DETAIL	DRN	CHKD	APPV	REV	DATE	DRAWING NUMBER	REFERENCE DRAWING TITLE
C	19/02/2020	Issued for Internal Review	ZT	BM					
B	17/02/2020	Issued for Internal Review	ZT	BM		19/02/2020			
A	07/01/2020	Issued for Internal Review	KM	BM		17/02/2020			

**METS ENGINEERING**  
PROCESS + INNOVATION

Resource Projects · Technology  
Integrated Services

L3, 44 Parliament Place, West Perth 6005  
PO BOX 1699, West Perth 6872

CLIENT: **DEEP SOUTH Resources Inc.**

PROJECT: **Haib Heap Leach Project**

DRAWN	SIGNED	DATE	TITLE:
KM		07/01	<b>Copper Processing - Extraction</b>
CHECKED	SIGNED	DATE	
DESIGNED	SIGNED	DATE	
VERIFIED	SIGNED	DATE	
CLIENT APP.	SIGNED	DATE	

Eq. No.:  
AREA: 400  
SHEET 1 OF 4

DRAWING NO. **J5329-P-PFD-400-001**

DO NOT SCALE	WEIGHT	SCALE	SHEET
	~ KG	1:1	A3
AREA No.	PROJECT No.	REV	
		C	

© THIS DRAWING IS THE PROPERTY OF M.E.T.S. P/L AND SHALL NOT BE USED OR REPRODUCED WITHOUT THE EXPRESS WRITTEN CONSENT OF THE CORPORATION

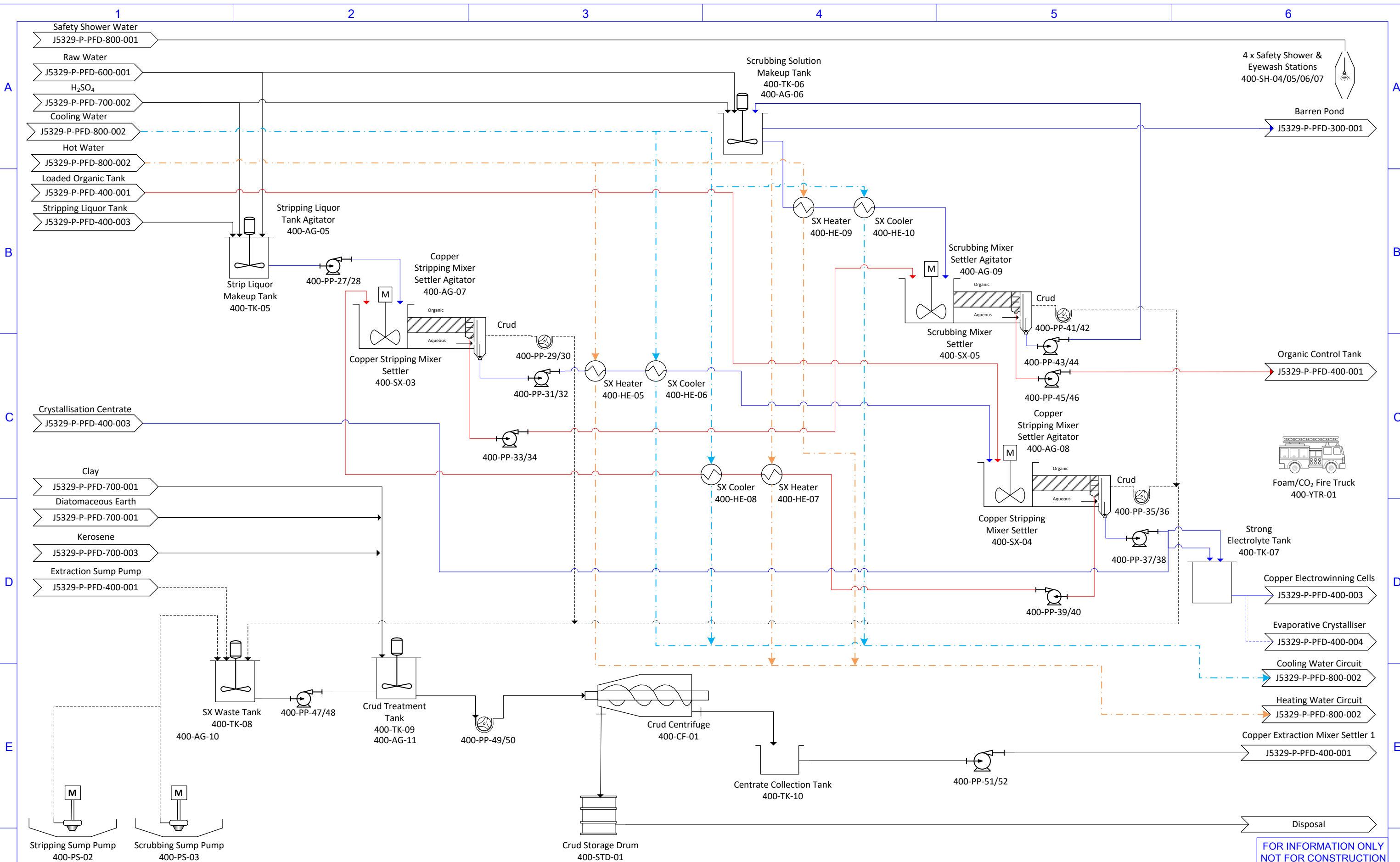

REV	DATE	REVISION DETAIL	DRN	CHKD	APPV	REV	DATE	DRAWING NUMBER	REFERENCE DRAWING TITLE
C	19/02/2020	Issued for Internal Review	ZT	BM					
B	17/02/2020	Issued for Internal Review	ZT	BM		19/02/2020			
A	07/01/2020	Issued for Internal Review	KM	BM		17/02/2020			

**METS ENGINEERING**  
PROCESS + INNOVATION

Resource Projects · Technology  
Integrated Services

L3, 44 Parliament Place, West Perth 6005  
PO BOX 1699, West Perth 6872

CLIENT: **DEEP SOUTH Resources Inc.**

PROJECT: **Haib Heap Leach Project**

DRAWN KM	SIGNED	DATE 07/01	TITLE: <b>Copper Processing - Extraction</b>
CHECKED	SIGNED	DATE	Eq. No.: AREA: 400 SHEET 2 OF 4
DESIGNED	SIGNED	DATE	DRAWING NO. J5329-P-PFD-400-002
VERIFIED	SIGNED	DATE	
CLIENT APP.	SIGNED	DATE	

DO NOT SCALE

WEIGHT ~ KG SCALE 1:1 SHEET A3

AREA NO. PROJECT NO. REV C

© THIS DRAWING IS THE PROPERTY OF M.E.T.S. P/L AND SHALL NOT BE USED OR REPRODUCED WITHOUT THE EXPRESS WRITTEN CONSENT OF THE CORPORATION

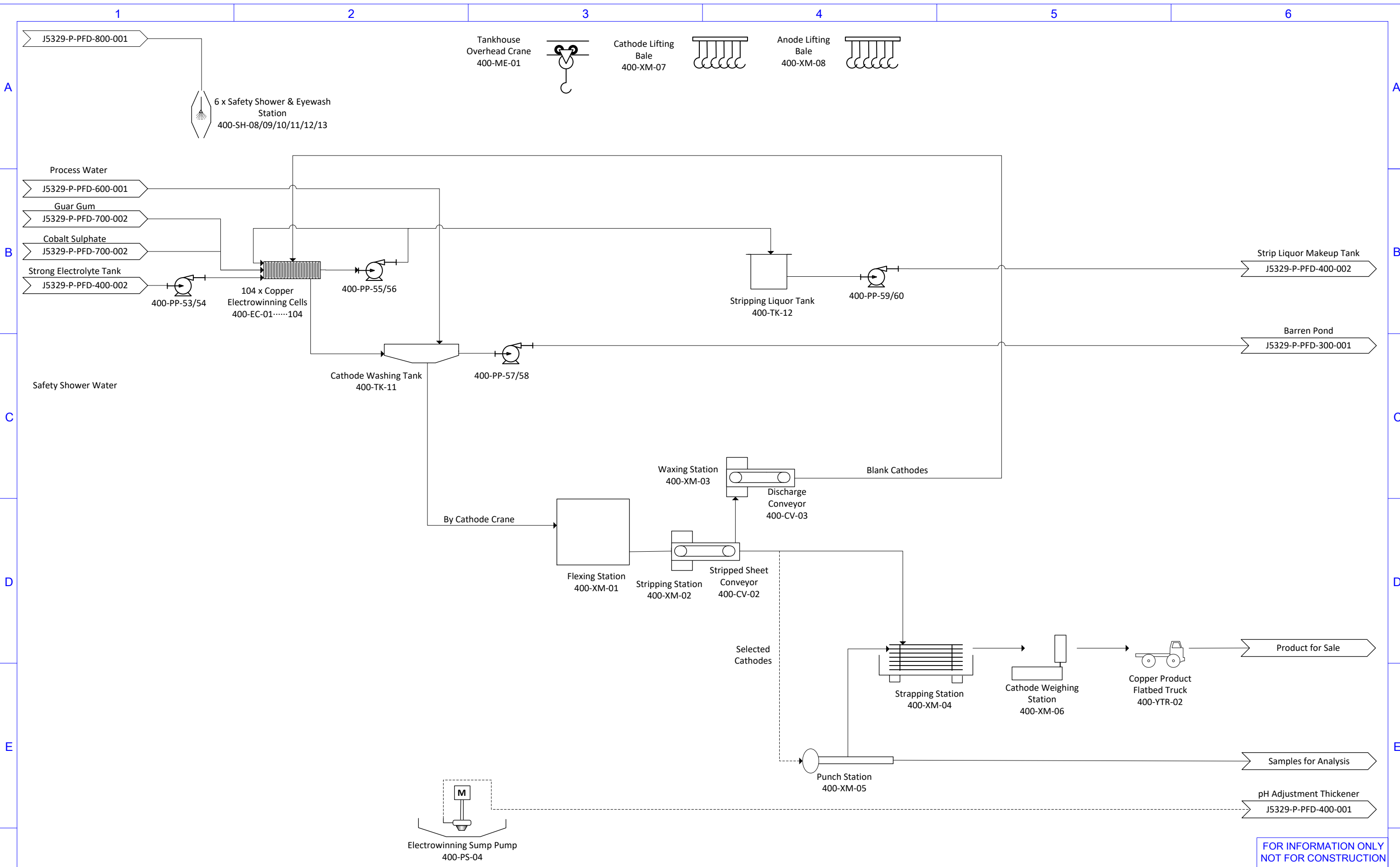

FOR INFORMATION ONLY  
NOT FOR CONSTRUCTION

REV	DATE	REVISION DETAIL	DRN	CHKD	APPV	REV	DATE	DRAWING NUMBER	REFERENCE DRAWING TITLE
B	19/02/2020	Updated after Internal Review	LZ						
B	17/02/2020	Updated after Internal Review	LZ	BM			19/02/2020		
A	07/01/2020	Issued for Internal Review	KM	BM			17/02/2020		

**METS ENGINEERING**  
PROCESS + INNOVATION

Resource Projects · Technology  
Integrated Services

L3, 44 Parliament Place, West Perth 6005  
PO BOX 1699, West Perth 6872

CLIENT: **DEEP SOUTH Resources Inc.**

PROJECT: **Haib Heap Leach Project**

DRAWN	SIGNED	DATE
KM		07/01
CHECKED	SIGNED	DATE
DESIGNED	SIGNED	DATE
VERIFIED	SIGNED	DATE
CLIENT APP.	SIGNED	DATE

TITLE: **Copper Processing - 8.5 Mtpa**

Eq. No.:  
AREA: 400  
SHEET 3 OF 4

DRAWING NO. **J5329-P-PFD-400-003**

WEIGHT	SCALE	SHEET
~ KG	1:1	A3
AREA No.	PROJECT No.	REV
		C

DO NOT SCALE



© THIS DRAWING IS THE PROPERTY OF M.E.T.S. P/L AND SHALL NOT BE USED OR REPRODUCED WITHOUT THE EXPRESS WRITTEN CONSENT OF THE CORPORATION

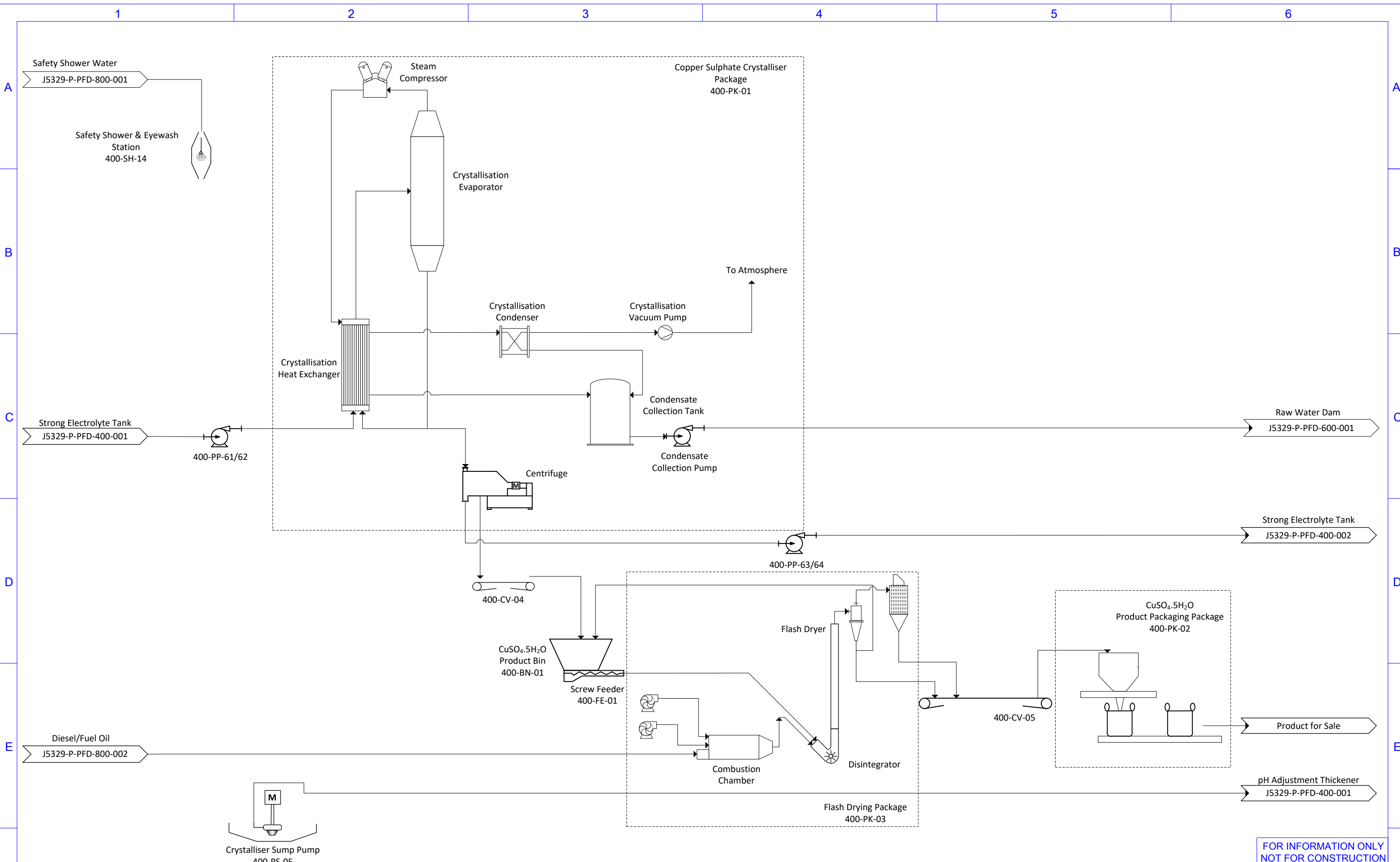

FOR INFORMATION ONLY  
NOT FOR CONSTRUCTION

REV	DATE	REVISION DETAIL	DRN	CHKD	APPV	REV	DATE	DRAWING NUMBER	REFERENCE DRAWING TITLE
A	04/03/2020	Issued for Internal Review	LZ						

**METS ENGINEERING**  
PROCESS + INNOVATION

Resource Projects · Technology  
Integrated Services

L3, 44 Parliament Place, West Perth 6005  
PO BOX 1699, West Perth 6872

CLIENT: **DEEP SOUTH Resources Inc.**

PROJECT: **Haib Heap Leach Project**

DRAWN	SIGNED	DATE
LZ		04/03
CHECKED	SIGNED	DATE
DESIGNED	SIGNED	DATE
VERIFIED	SIGNED	DATE
CLIENT APP.	SIGNED	DATE

TITLE: **Copper Processing - 8.5 Mtpa**

Eq. No.:  
AREA: 400  
SHEET 4 OF 4

DRAWING NO. **J5329-P-PFD-400-004**

DO NOT SCALE

WEIGHT ~ KG	SCALE 1:1	SHEET A3
AREA No.	PROJECT No.	REV A

© THIS DRAWING IS THE PROPERTY OF M.E.T.S. P/L AND SHALL NOT BE USED OR REPRODUCED WITHOUT THE EXPRESS WRITTEN CONSENT OF THE CORPORATION

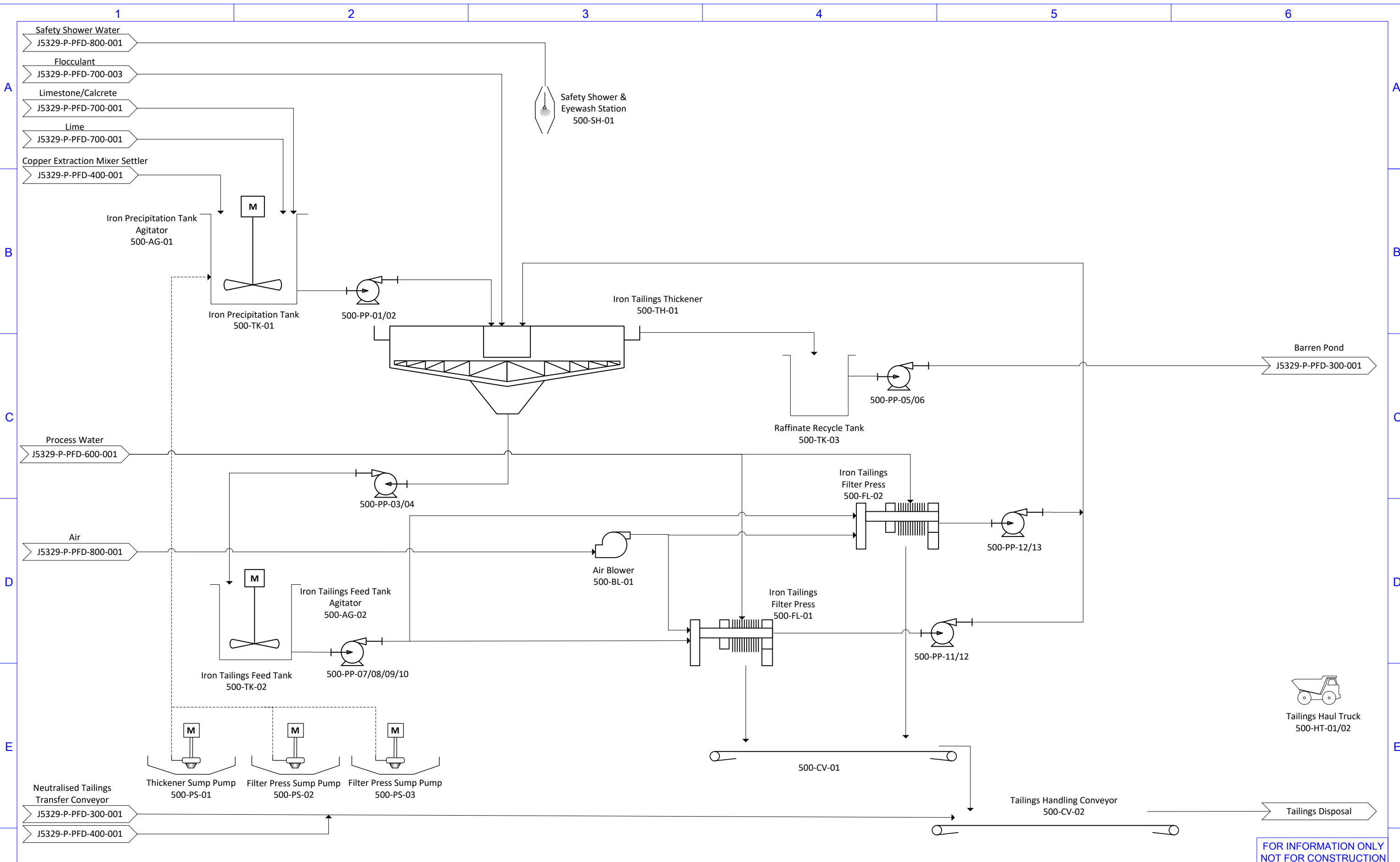

FOR INFORMATION ONLY  
NOT FOR CONSTRUCTION

REV	DATE	REVISION DETAIL	DRN	CHKD	APPV	REV	DATE	DRAWING NUMBER	REFERENCE DRAWING TITLE
C	19/02/2020	Updated after Internal Review							
B	17/02/2020	Updated after Internal Review	LZ	BM		19/02/2020			
A	07/01/2020	Issued for Internal Review	KM	BM		17/02/2020			

**METS ENGINEERING**  
PROCESS + INNOVATION

Resource Projects · Technology  
Integrated Services

L3, 44 Parliament Place, West Perth 5005  
PO BOX 1699, West Perth 6872

CLIENT: **DEEP SOUTH Resources Inc.**

PROJECT: **Haib Heap Leach Project**

DRAWN	SIGNED	DATE	TITLE:
KM		07/01	<b>Iron Removal</b>
CHECKED	SIGNED	DATE	
DESIGNED	SIGNED	DATE	
VERIFIED	SIGNED	DATE	
CLIENT APP.	SIGNED	DATE	
Eq. No.: AREA: 500 SHEET 1 OF 1			DO NOT SCALE
DRAWING NO. J5329-P-PFD-500-001			
WEIGHT	SCALE	SHEET	
~ KG	1:1	A3	
AREA No.	PROJECT No.	REV	
		C	

© THIS DRAWING IS THE PROPERTY OF M.E.T.S. P/L AND SHALL NOT BE USED OR REPRODUCED WITHOUT THE EXPRESS WRITTEN CONSENT OF THE CORPORATION

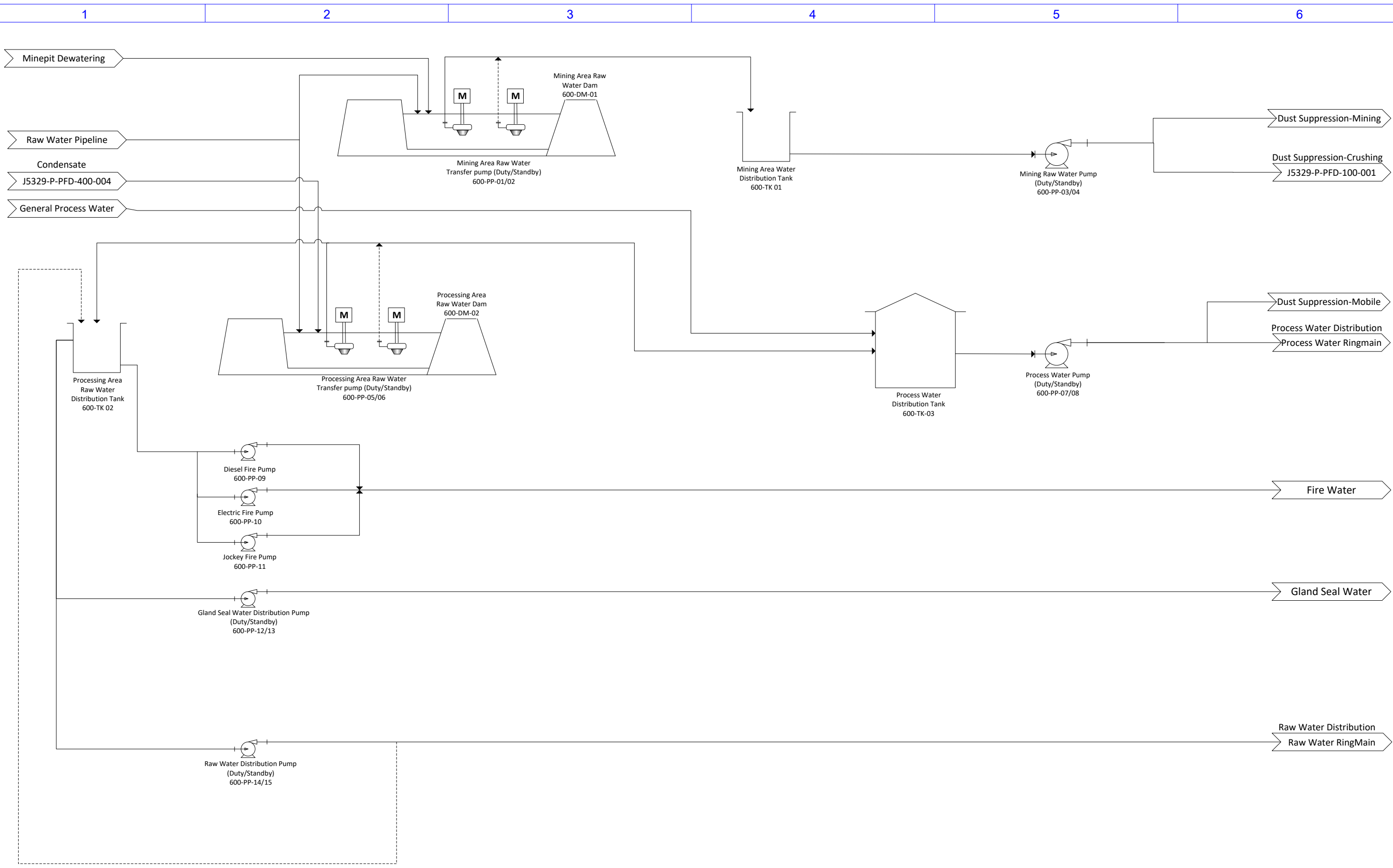

FOR INFORMATION ONLY  
NOT FOR CONSTRUCTION

REV	DATE	REVISION DETAIL	DRN	CHKD	APPV	REV	DATE	DRAWING NUMBER	REFERENCE DRAWING TITLE
B	19/02/2020	Updated after Internal Review	LZ						
A	07/01/2020	Issued for Internal Review	KM	BM		17/02/2020			

**METS ENGINEERING**  
PROCESS + INNOVATION

Resource Projects · Technology  
Integrated Services

L3, 44 Parliament Place, West Perth 6005  
PO BOX 1699, West Perth 6872

CLIENT: **DEEP SOUTH Resources Inc.**

PROJECT: **Haib Heap Leach Project**

DRAWN	SIGNED	DATE
KM		07/01
CHECKED	SIGNED	DATE
DESIGNED	SIGNED	DATE
VERIFIED	SIGNED	DATE
CLIENT APP.	SIGNED	DATE

TITLE: **Process and Raw Water**

Eq. No.:  
AREA:600  
SHEET 1 OF 1

DRAWING NO. **J5329-P-PFD-600-001**

DO NOT SCALE		
WEIGHT ~ KG	SCALE 1:1	SHEET A3
AREA No.	PROJECT No.	REV B

© THIS DRAWING IS THE PROPERTY OF M.E.T.S. P/L AND SHALL NOT BE USED OR REPRODUCED WITHOUT THE EXPRESS WRITTEN CONSENT OF THE CORPORATION

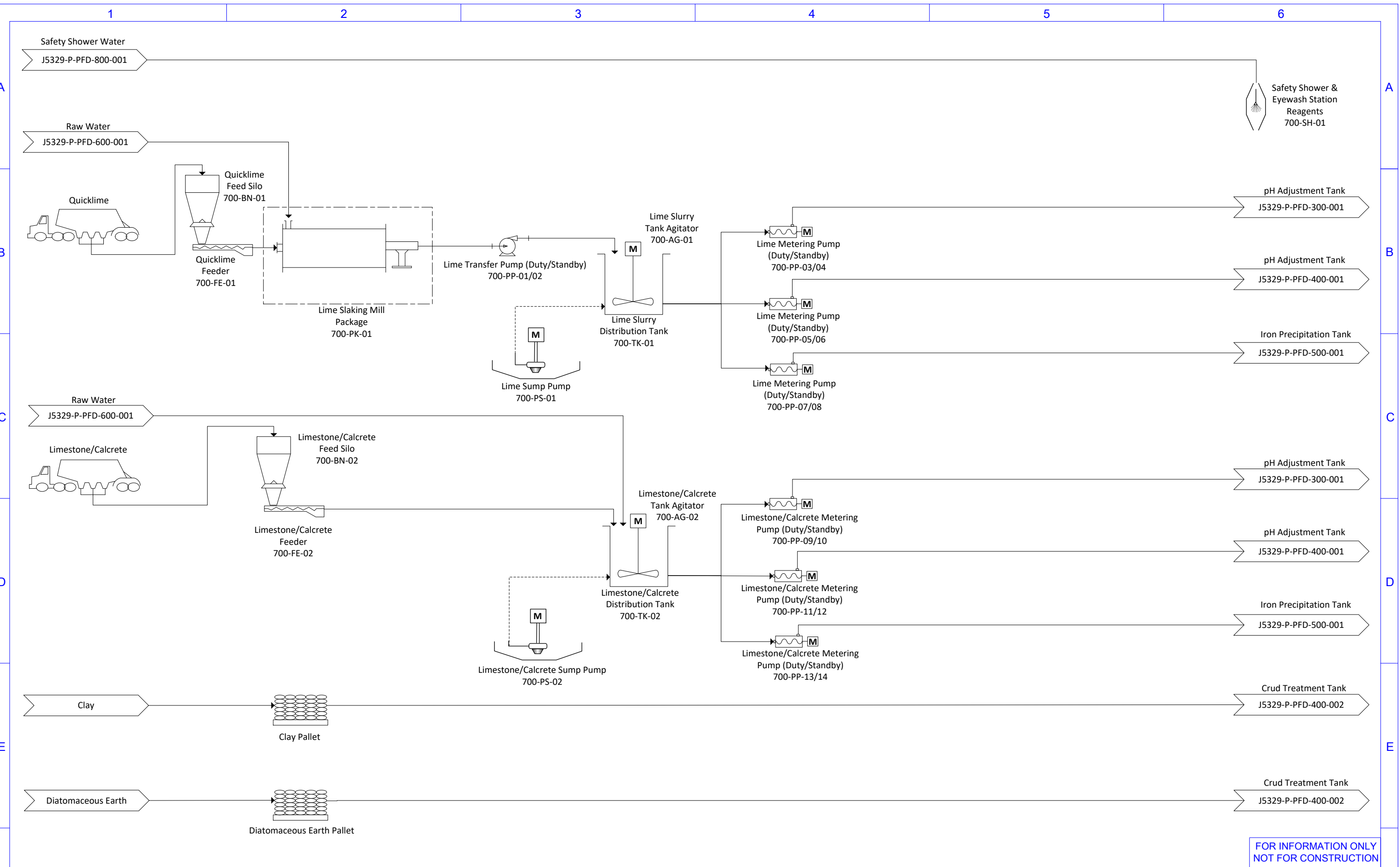

FOR INFORMATION ONLY  
NOT FOR CONSTRUCTION

REV	DATE	REVISION DETAIL	DRN	CHKD	APPV	REV	DATE	DRAWING NUMBER	REFERENCE DRAWING TITLE
C	19/02/2020	Updated after internal Review	LZ						
B	17/02/2020	Updated after internal Review	LZ	BM			19/02/2020		
A	07/01/2020	Issued for Internal Review	KM	BM			17/02/2020		

**METS ENGINEERING**  
PROCESS + INNOVATION

Resource Projects · Technology  
Integrated Services

L3, 44 Parliament Place, West Perth 6005  
PO BOX 1699, West Perth 6872

CLIENT: **DEEP SOUTH Resources Inc.**

PROJECT: **Haib Heap Leach Project**

DRAWN	SIGNED	DATE	TITLE:
KM		07/01	<b>Reagents</b> Eq. No.: AREA: 700 SHEET 1 OF 3 DRAWING NO. J5329-P-PFD-700-001
CHECKED	SIGNED	DATE	
DESIGNED	SIGNED	DATE	
VERIFIED	SIGNED	DATE	
CLIENT APP.	SIGNED	DATE	

DO NOT SCALE

WEIGHT	SCALE	SHEET
~ KG	1:1	A3
AREA No.	PROJECT No.	REV
		C

© THIS DRAWING IS THE PROPERTY OF M.E.T.S. P/L AND SHALL NOT BE USED OR REPRODUCED WITHOUT THE EXPRESS WRITTEN CONSENT OF THE CORPORATION

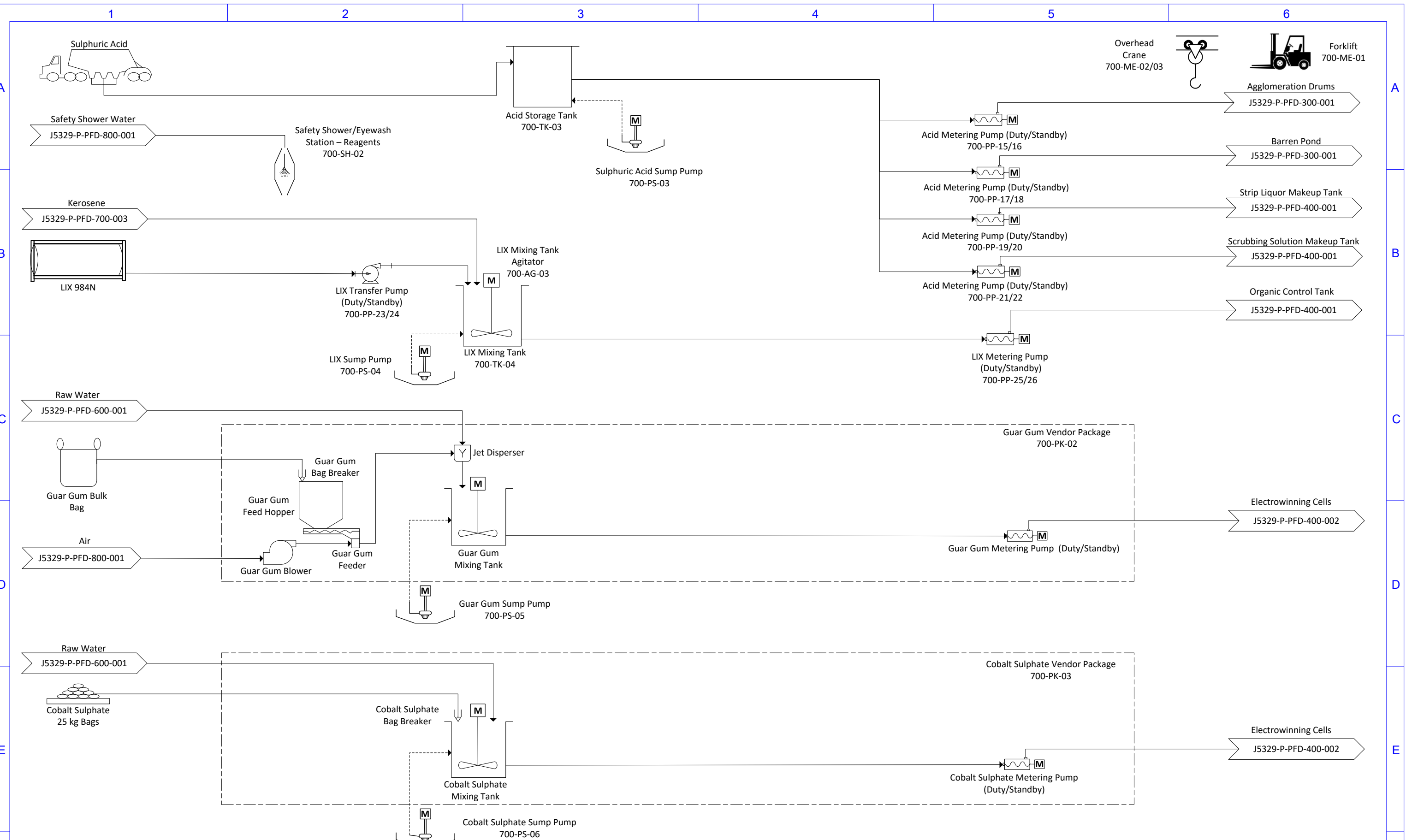

FOR INFORMATION ONLY  
NOT FOR CONSTRUCTION

REV	DATE	REVISION DETAIL	DRN	CHKD	APPV	REV	DATE	DRAWING NUMBER	REFERENCE DRAWING TITLE
C	19/02/2020	Updated after internal Review	LZ						
B	17/02/2020	Updated after internal Review	LZ	BM			19/02/2020		
A	07/01/2020	Issued for Internal Review	KM	BM			17/02/2020		

**METS ENGINEERING**  
PROCESS + INNOVATION

Resource Projects · Technology  
Integrated Services

L3, 44 Parliament Place, West Perth 6005  
PO BOX 1699, West Perth 6872

CLIENT: **DEEP SOUTH Resources Inc.**

PROJECT: **Haib Heap Leach Project**

DRAWN	SIGNED	DATE	TITLE:
KM		07/01	<b>Reagents</b>
CHECKED	SIGNED	DATE	
DESIGNED	SIGNED	DATE	
VERIFIED	SIGNED	DATE	
CLIENT APP.	SIGNED	DATE	

Eq. No.: AREA:700  
SHEET 2 OF 3

DRAWING NO. **J5329-P-PFD-700-002**

DO NOT SCALE	WEIGHT ~ KG	SCALE 1:1	SHEET A3
AREA No.	PROJECT No.	REV C	

F

© THIS DRAWING IS THE PROPERTY OF M.E.T.S. P/L AND SHALL NOT BE USED OR REPRODUCED WITHOUT THE EXPRESS WRITTEN CONSENT OF THE CORPORATION

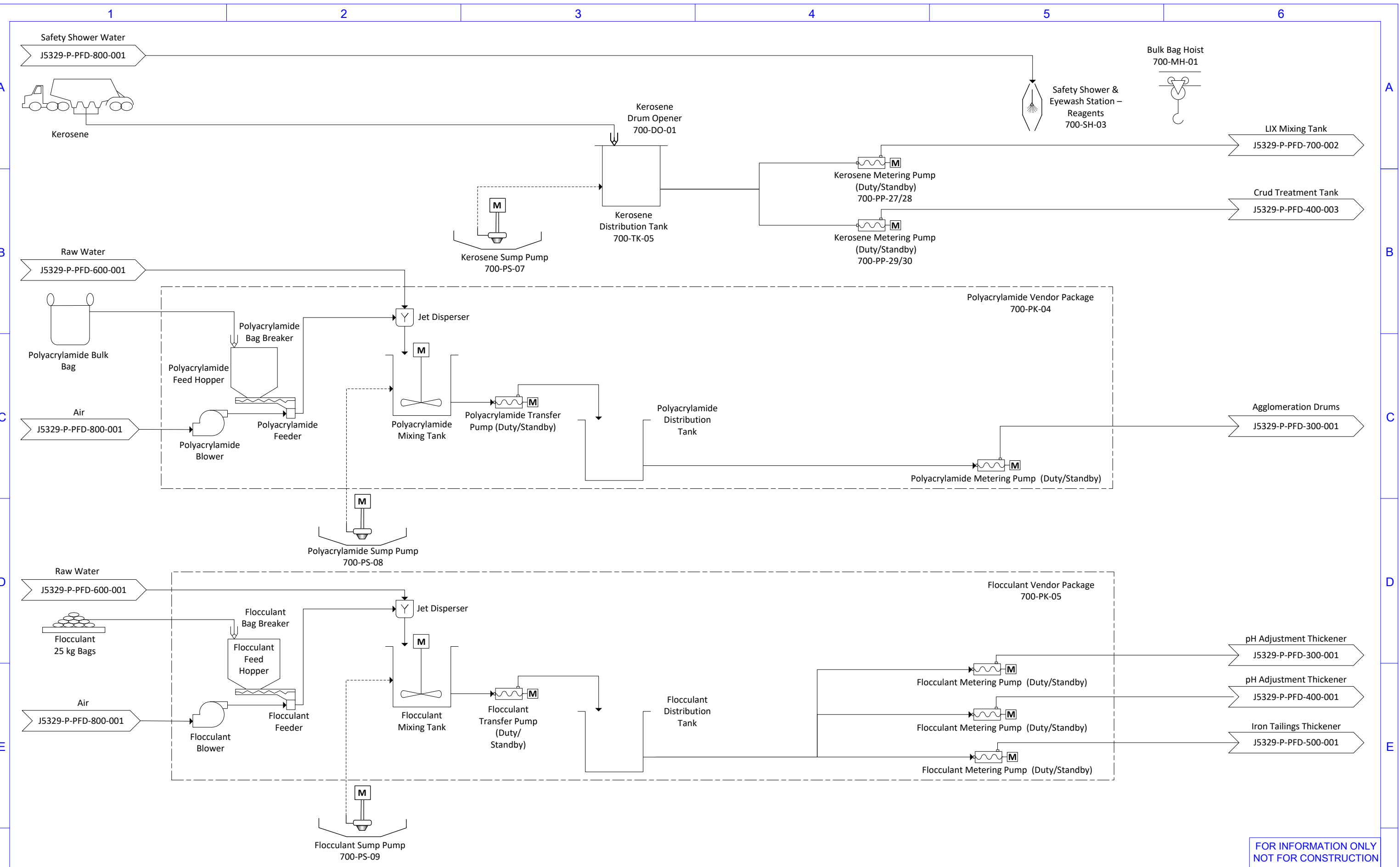

FOR INFORMATION ONLY  
NOT FOR CONSTRUCTION

REV	DATE	REVISION DETAIL	DRN	CHKD	APPV	REV	DATE	DRAWING NUMBER	REFERENCE DRAWING TITLE
C	19/02/2020	Updated after internal Review	LZ						
B	17/02/2020	Updated after internal Review	LZ	BM			19/02/2020		
A	07/01/2020	Issued for Internal Review	KM	BM			17/02/2020		

**METS ENGINEERING**  
PROCESS + INNOVATION

Resource Projects · Technology  
Integrated Services

L3, 44 Parliament Place, West Perth 6005  
PO BOX 1699, West Perth 6872

CLIENT: **DEEP SOUTH Resources Inc.**

PROJECT: **Haib Heap Leach Project**

DRAWN KM	SIGNED	DATE 07/01	<b>Reagents</b> Eq. No.: AREA:700 SHEET 3 OF 3 DRAWING NO. J5329-P-PFD-700-003
CHECKED	SIGNED	DATE	
DESIGNED	SIGNED	DATE	
VERIFIED	SIGNED	DATE	
CLIENT APP.	SIGNED	DATE	

DO NOT SCALE

WEIGHT ~ KG	SCALE 1:1	SHEET A3
AREA No.	PROJECT No.	REV C

© THIS DRAWING IS THE PROPERTY OF M.E.T.S. P/L AND SHALL NOT BE USED OR REPRODUCED WITHOUT THE EXPRESS WRITTEN CONSENT OF THE CORPORATION

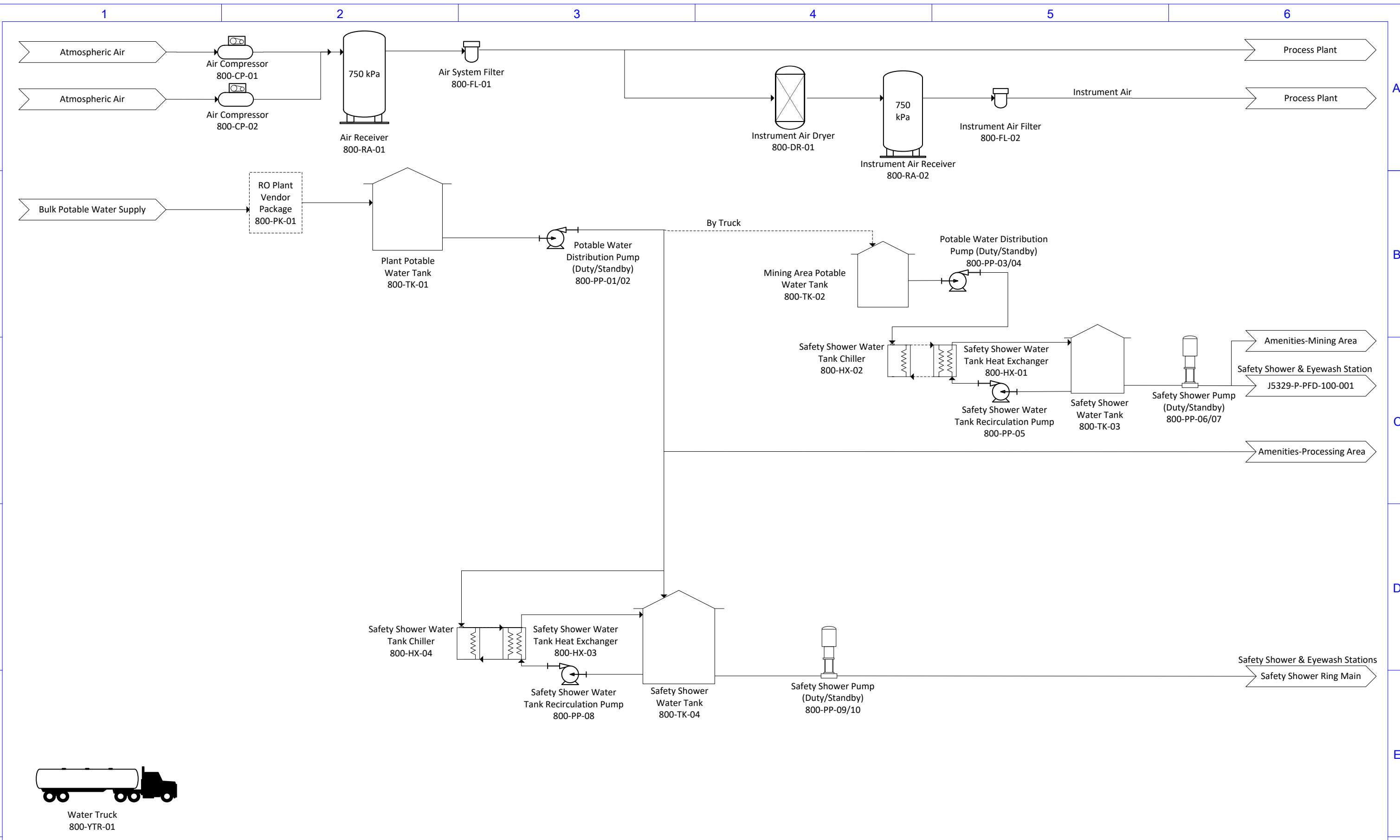

FOR INFORMATION ONLY  
NOT FOR CONSTRUCTION

REV	DATE	REVISION DETAIL	DRN	CHKD	APPV	REV	DATE	DRAWING NUMBER	REFERENCE DRAWING TITLE
B	19/02/2020	Updated after Internal Review	LZ						
A	07/01/2020	Issued for Internal Review	KM	BM		19/02/2020			

**METS ENGINEERING**  
PROCESS + INNOVATION

Resource Projects · Technology  
Integrated Services

L3, 44 Parliament Place, West Perth 6005  
PO BOX 1699, West Perth 6872

CLIENT: **DEEP SOUTH Resources Inc.**

PROJECT: **Haib Heap Leach Project**

DRAWN	SIGNED	DATE	TITLE:
KM		07/01	Services Eq. No.: AREA:800 SHEET 1 OF 2 DRAWING NO. J5329-P-PFD-800-001
CHECKED	SIGNED	DATE	
DESIGNED	SIGNED	DATE	
VERIFIED	SIGNED	DATE	
CLIENT APP.	SIGNED	DATE	

DO NOT SCALE	WEIGHT ~ KG	SCALE 1:1	SHEET A3
AREA No.	PROJECT No.	REV B	

1 2 3 4 5 6

© THIS DRAWING IS THE PROPERTY OF M.E.T.S. P/L AND SHALL NOT BE USED OR REPRODUCED WITHOUT THE EXPRESS WRITTEN CONSENT OF THE CORPORATION

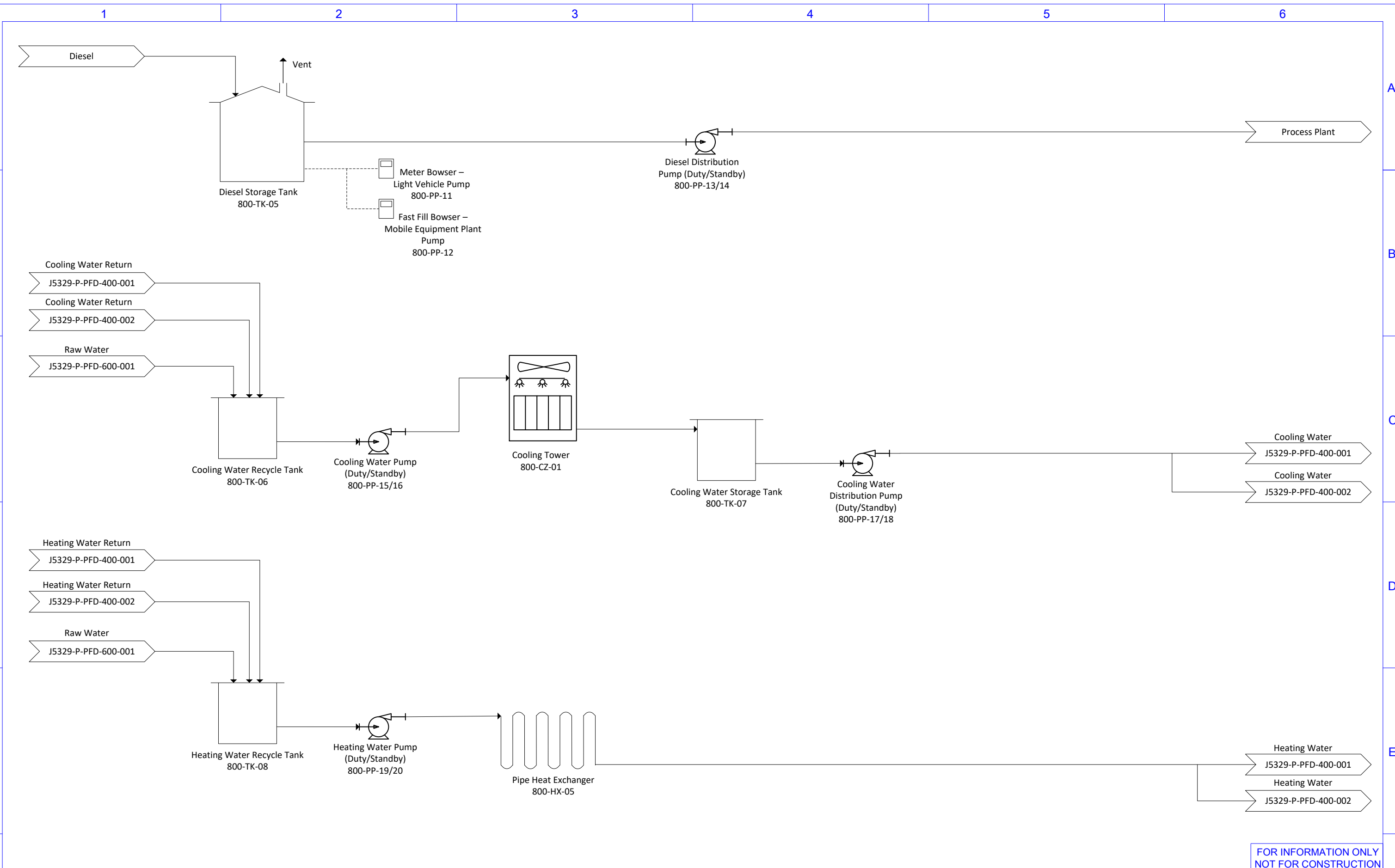

FOR INFORMATION ONLY  
NOT FOR CONSTRUCTION

REV	DATE	REVISION DETAIL	DRN	CHKD	APPV	REV	DATE	DRAWING NUMBER	REFERENCE DRAWING TITLE
B	19/02/2020	Updated after Internal Review	LZ						
A	07/01/2020	Issued for Internal Review	KM	BM		19/02/2020			

**METS ENGINEERING**  
PROCESS + INNOVATION

Resource Projects · Technology  
Integrated Services

L3, 44 Parliament Place, West Perth 6005  
PO BOX 1699, West Perth 6872

CLIENT: **DEEP SOUTH Resources Inc.**

PROJECT: **Haib Heap Leach Project**

DRAWN	SIGNED	DATE	TITLE:
KM		07/01	Services Eq. No.: AREA:800 SHEET 2 OF 2 DRAWING NO. J5329-P-PFD-800-002
CHECKED	SIGNED	DATE	
DESIGNED	SIGNED	DATE	
VERIFIED	SIGNED	DATE	
CLIENT APP.	SIGNED	DATE	

DO NOT SCALE		
WEIGHT ~ KG	SCALE 1:1	SHEET A3
AREA No.	PROJECT No.	REV A



© THIS DRAWING IS THE PROPERTY OF M.E.T.S. P/L AND SHALL NOT BE USED OR REPRODUCED WITHOUT THE EXPRESS WRITTEN CONSENT OF THE CORPORATION

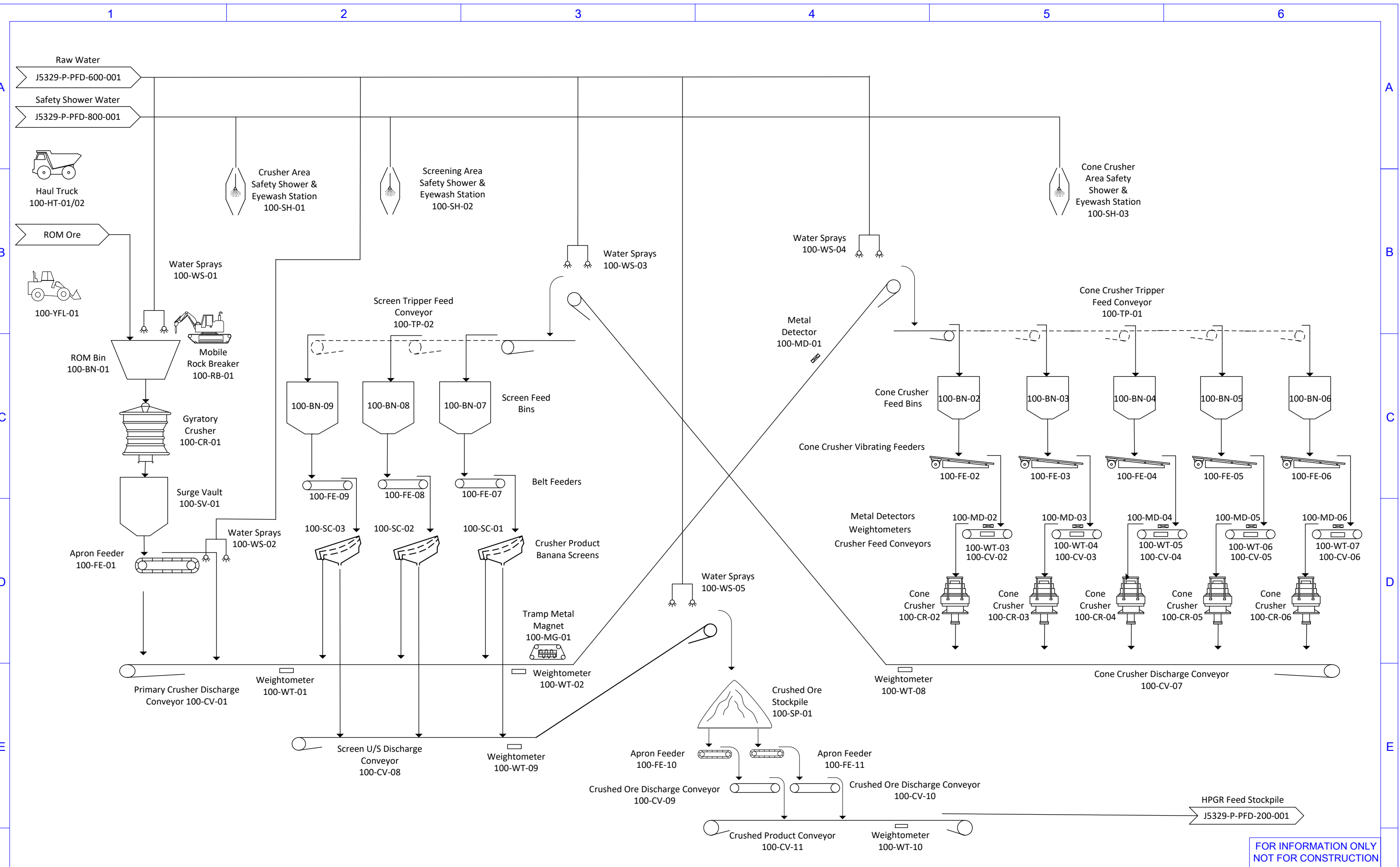

FOR INFORMATION ONLY  
NOT FOR CONSTRUCTION

REV	DATE	REVISION DETAIL	DRN	CHKD	APPV	REV	DATE	DRAWING NUMBER	REFERENCE DRAWING TITLE
C	17/02/2020	Updated after Internal Review	LZ	BM			17/02/2020		
B	23/01/2020	Updated after Internal Review	ZT	BM			17/02/2020		
A	07/01/2020	Issued for Internal Review	KM	BM			22/01/2020		

Resource Projects · Technology  
Integrated Services  
L3, 44 Parliament Place, West Perth 6005  
PO BOX 1699, West Perth 6872

CLIENT:

PROJECT: Haib Heap Leach Project

DRAWN	SIGNED	DATE	TITLE:
KM		07/01	20 Mtpa Crushing
CHECKED	SIGNED	DATE	
DESIGNED	SIGNED	DATE	
VERIFIED	SIGNED	DATE	
CLIENT APP.	SIGNED	DATE	Eq. No.: AREA: 100 SHEET 1 OF 1 DRAWING NO. J5329-P-PFD-100-001

DO NOT SCALE

WEIGHT	SCALE	SHEET
~ KG	1:1	A3
AREA No.	PROJECT No.	REV
		C

1 2 3 4 5 6

© THIS DRAWING IS THE PROPERTY OF M.E.T.S. P/L AND SHALL NOT BE USED OR REPRODUCED WITHOUT THE EXPRESS WRITTEN CONSENT OF THE CORPORATION

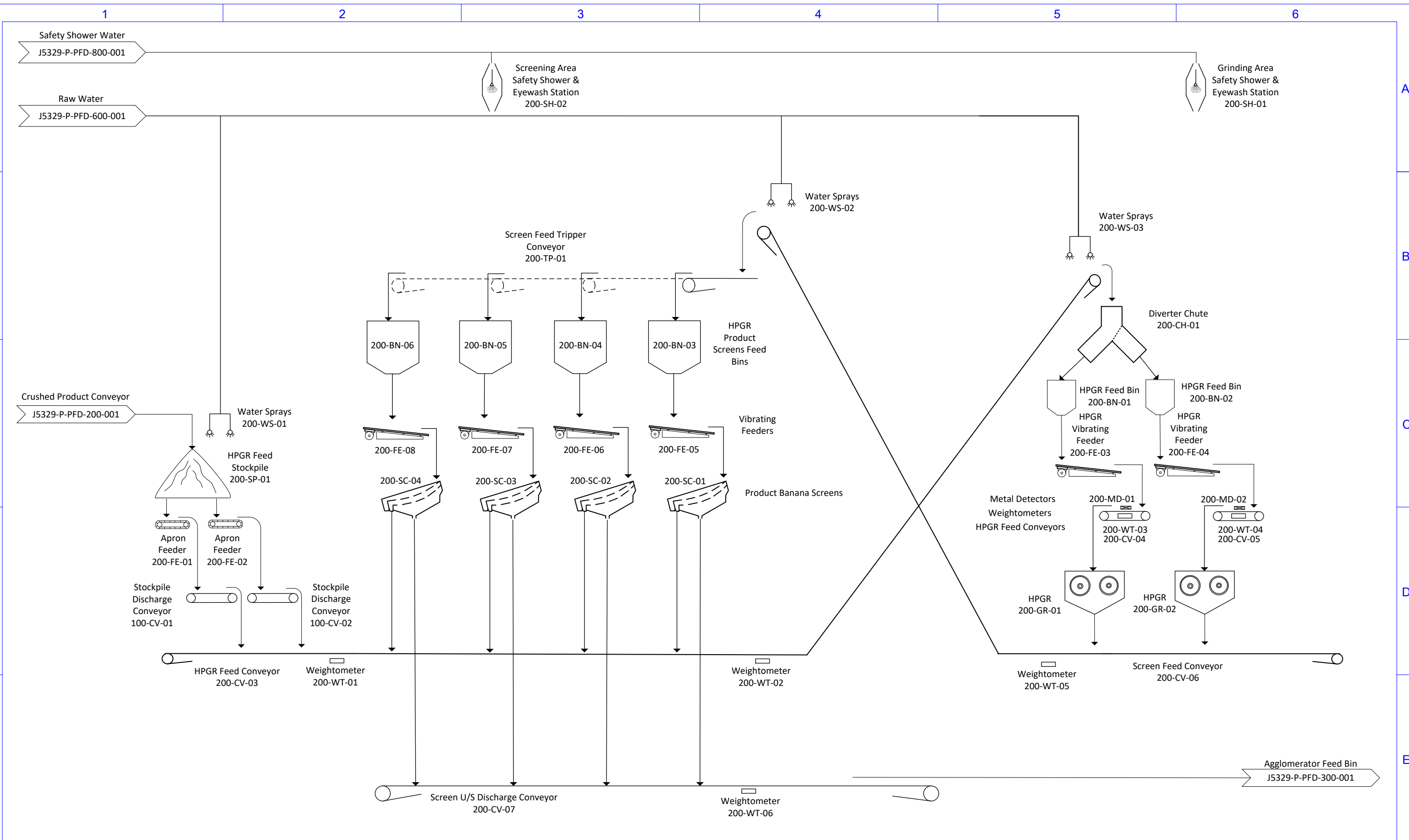

FOR INFORMATION ONLY  
NOT FOR CONSTRUCTION

REV	DATE	REVISION DETAIL	DRN	CHKD	APPV	REV	DATE	DRAWING NUMBER	REFERENCE DRAWING TITLE
C	17/02/2020	Updated after Internal Review	LZ	BM			17/02/2020		
B	23/01/2020	Updated after Internal Review	ZT	BM			17/02/2020		
A	07/01/2020	Issued for Internal Review	KM	BM			22/01/2020		

**METS ENGINEERING**  
PROCESS + INNOVATION

Resource Projects · Technology  
Integrated Services

L3, 44 Parliament Place, West Perth 6005  
PO BOX 1699, West Perth 6872

CLIENT: **DEEP SOUTH Resources Inc.**

PROJECT: **Haib Heap Leach Project**

DRAWN	SIGNED	DATE
KM		07/01
CHECKED	SIGNED	DATE
DESIGNED	SIGNED	DATE
VERIFIED	SIGNED	DATE
CLIENT APP.	SIGNED	DATE

TITLE: **20 Mtpa High Pressure Grinding Rolls (HPGR)**

Eq. No.:  
AREA: 200  
SHEET 1 OF 1

DRAWING NO.: **J5329-P-PFD-200-001**

DO NOT SCALE

WEIGHT ~ KG	SCALE 1:1	SHEET A3
AREA No.	PROJECT No.	REV C

© THIS DRAWING IS THE PROPERTY OF M.E.T.S. P/L AND SHALL NOT BE USED OR REPRODUCED WITHOUT THE EXPRESS WRITTEN CONSENT OF THE CORPORATION

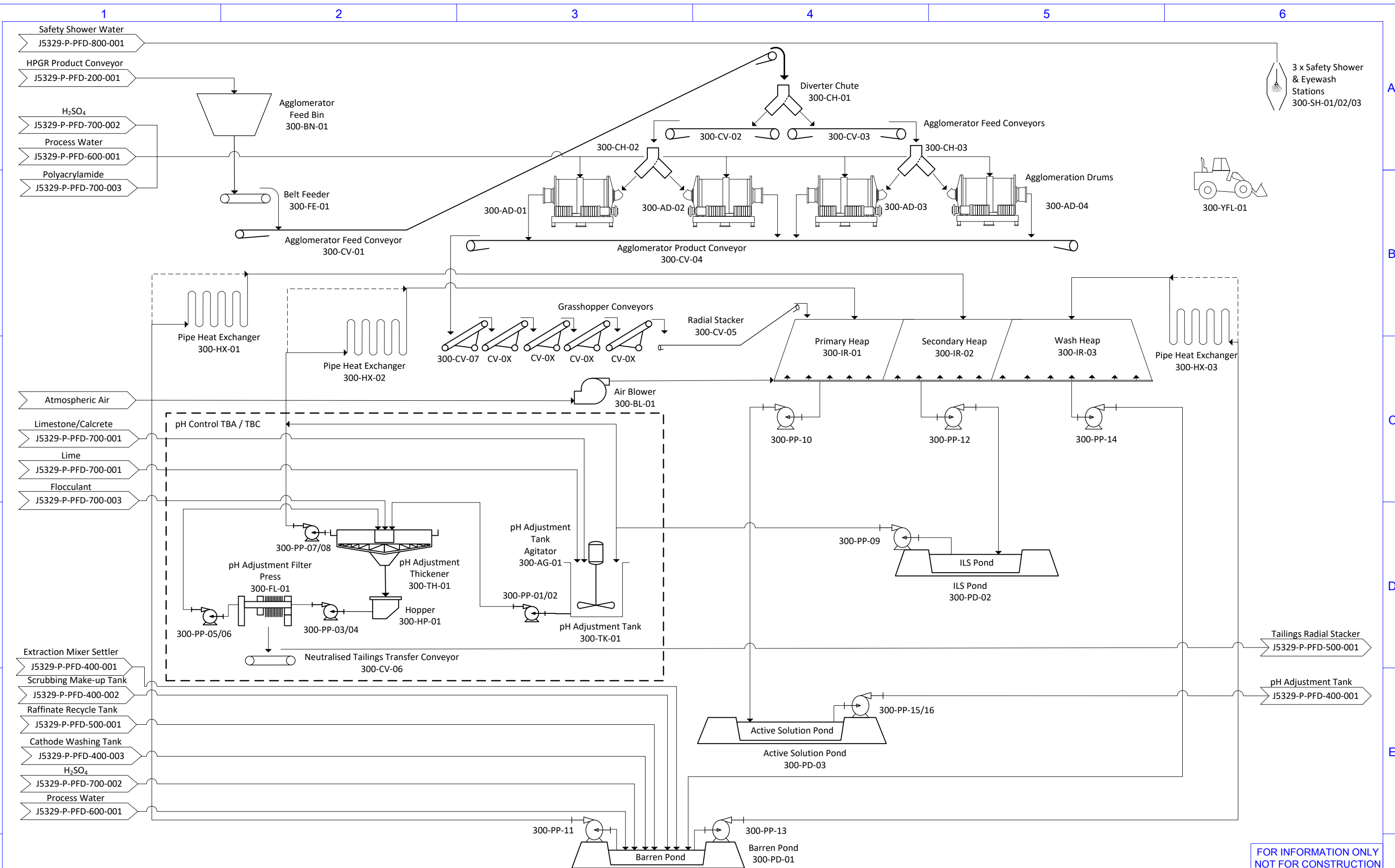

FOR INFORMATION ONLY  
NOT FOR CONSTRUCTION

REV	DATE	REVISION DETAIL	DRN	CHKD	APPV	REV	DATE	DRAWING NUMBER	REFERENCE DRAWING TITLE
C	19/02/2020	Updated after Internal Review	LZ	BM			19/02/2020		
B	23/01/2020	Updated After Internal Review	ZT	BM			19/02/2020		
A	07/01/2020	Issued for Internal Review	KM	BM			22/01/2020		

**METS ENGINEERING**  
PROCESS + INNOVATION

Resource Projects · Technology  
Integrated Services

L3, 44 Parliament Place, West Perth 6005  
PO BOX 1699, West Perth 6872

CLIENT: **DEEP SOUTH Resources Inc.**

PROJECT: **Haib Heap Leach Project**

DRAWN	SIGNED	DATE	TITLE:
KM		07/01	20Mtpa Agglomeration and Heap Leach
CHECKED	SIGNED	DATE	
DESIGNED	SIGNED	DATE	
VERIFIED	SIGNED	DATE	
CLIENT APP.	SIGNED	DATE	

Eq. No.:	AREA:300	DO NOT SCALE
SHEET 1 OF 1	SCALE 1:1	SHEET A3
DRAWING NO. J5329-P-PFD-300-001	AREA No.	PROJECT No.
		REV C

1 2 3 4 5 6

© THIS DRAWING IS THE PROPERTY OF M.E.T.S. P/L AND SHALL NOT BE USED OR REPRODUCED WITHOUT THE EXPRESS WRITTEN CONSENT OF THE CORPORATION

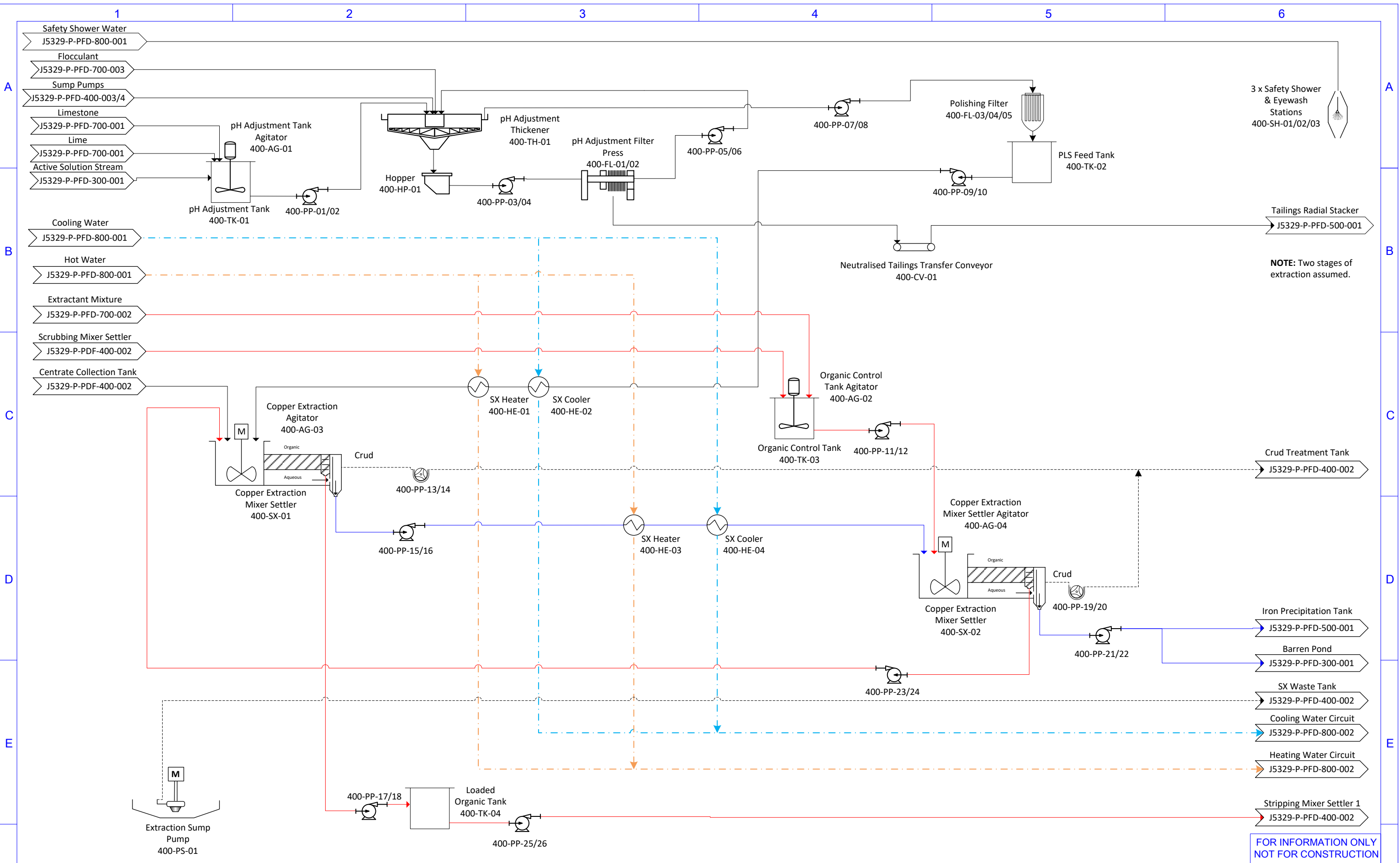

FOR INFORMATION ONLY  
NOT FOR CONSTRUCTION

REV	DATE	REVISION DETAIL	DRN	CHKD	APPV	REV	DATE	DRAWING NUMBER	REFERENCE DRAWING TITLE
C	19/02/2020	Issued for Internal Review	ZT	BM					
B	17/02/2020	Issued for Internal Review	ZT	BM		19/02/2020			
A	07/01/2020	Issued for Internal Review	KM	BM		17/02/2020			

**METS ENGINEERING**  
PROCESS + INNOVATION

Resource Projects · Technology  
Integrated Services

L3, 44 Parliament Place, West Perth 6005  
PO BOX 1699, West Perth 6872

CLIENT: **DEEP SOUTH Resources Inc.**

PROJECT: **Haib Heap Leach Project**

DRAWN	SIGNED	DATE	TITLE:
KM		07/01	<b>Copper Processing - Extraction</b>
CHECKED	SIGNED	DATE	
DESIGNED	SIGNED	DATE	
VERIFIED	SIGNED	DATE	
CLIENT APP.	SIGNED	DATE	

Eq. No.:  
AREA: 400  
SHEET 1 OF 4

DRAWING NO. **J5329-P-PFD-400-001**

DO NOT SCALE	WEIGHT	SCALE	SHEET
	~ KG	1:1	A3
AREA No.	PROJECT No.	REV	
		C	

© THIS DRAWING IS THE PROPERTY OF M.E.T.S. P/L AND SHALL NOT BE USED OR REPRODUCED WITHOUT THE EXPRESS WRITTEN CONSENT OF THE CORPORATION

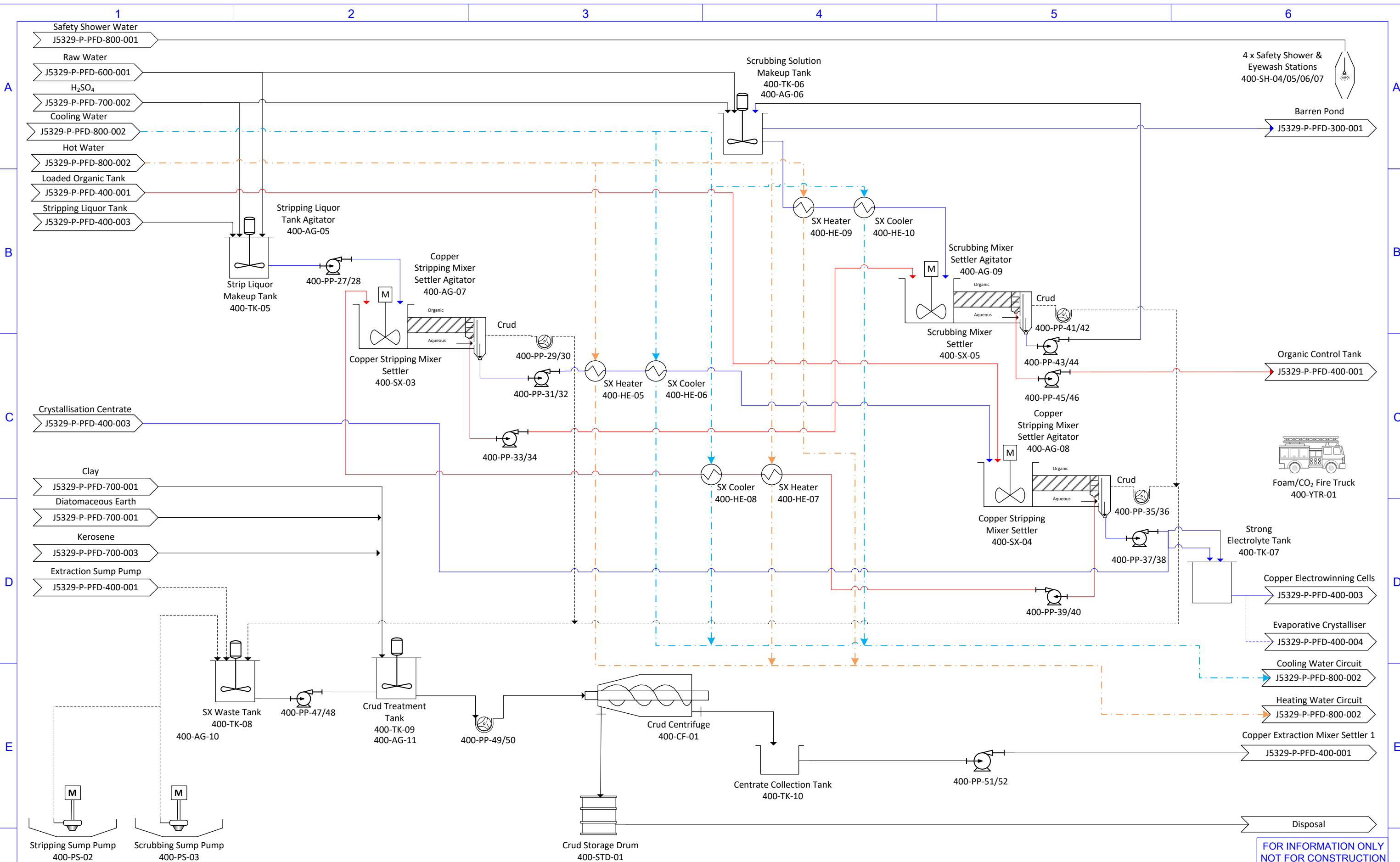

FOR INFORMATION ONLY  
NOT FOR CONSTRUCTION

REV	DATE	REVISION DETAIL	DRN	CHKD	APPV	REV	DATE	DRAWING NUMBER	REFERENCE DRAWING TITLE
C	19/02/2020	Issued for Internal Review	ZT	BM					
B	17/02/2020	Issued for Internal Review	ZT	BM		19/02/2020			
A	07/01/2020	Issued for Internal Review	KM	BM		17/02/2020			

**METS ENGINEERING**  
PROCESS + INNOVATION

Resource Projects · Technology  
Integrated Services

L3, 44 Parliament Place, West Perth 6005  
PO BOX 1699, West Perth 6872

CLIENT: **DEEP SOUTH Resources Inc.**

PROJECT: **Haib Heap Leach Project**

DRAWN	SIGNED	DATE	TITLE:
KM		07/01	<b>Copper Processing - Extraction</b>
CHECKED	SIGNED	DATE	
DESIGNED	SIGNED	DATE	
VERIFIED	SIGNED	DATE	
CLIENT APP.	SIGNED	DATE	

Eq. No.:  
AREA: 400  
SHEET 2 OF 4

DRAWING NO. **J5329-P-PFD-400-002**

DO NOT SCALE	WEIGHT	SCALE	SHEET
	~ KG	1:1	A3
AREA NO.	PROJECT NO.	REV	
		C	

F

© THIS DRAWING IS THE PROPERTY OF M.E.T.S. P/L AND SHALL NOT BE USED OR REPRODUCED WITHOUT THE EXPRESS WRITTEN CONSENT OF THE CORPORATION

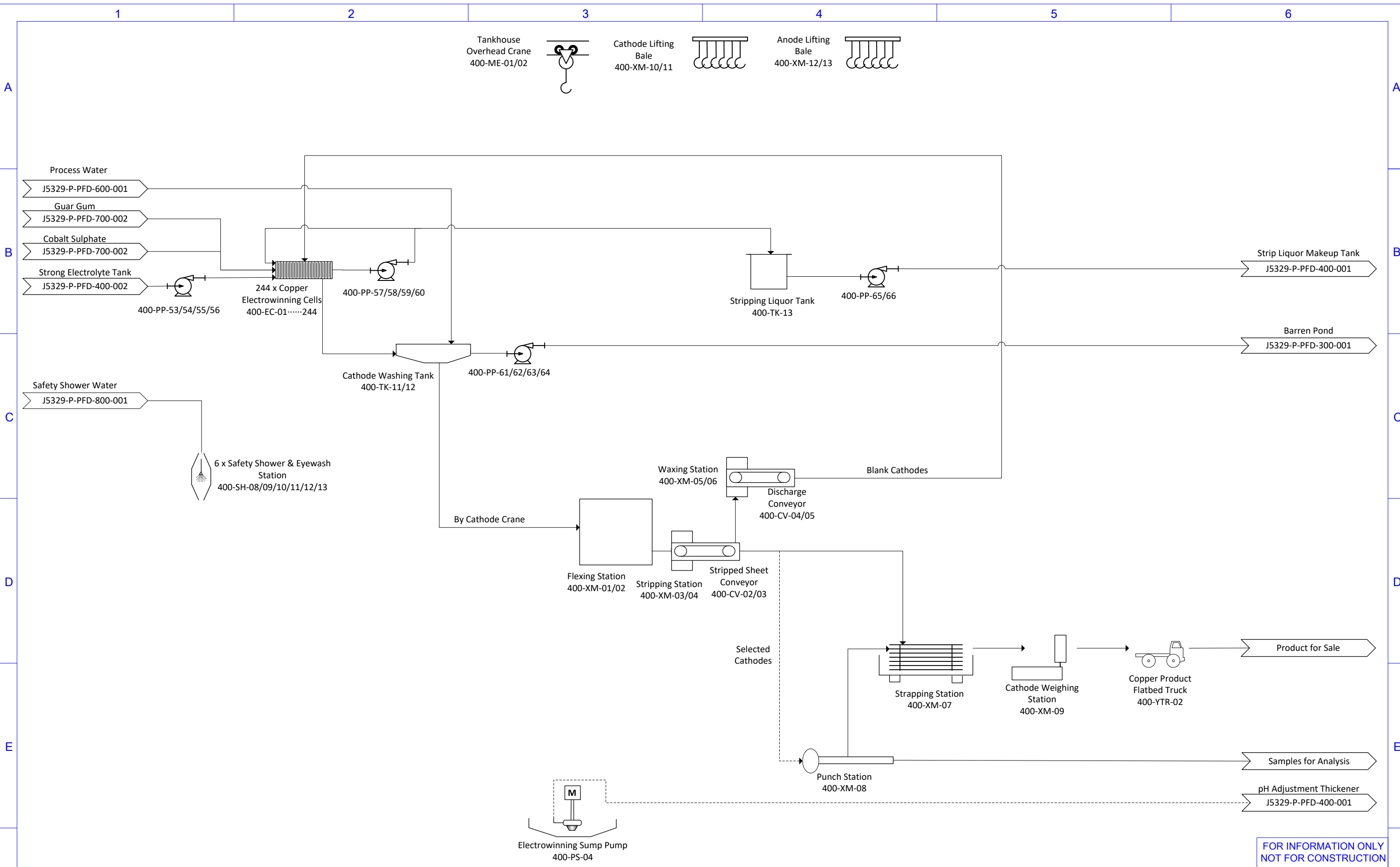

FOR INFORMATION ONLY  
NOT FOR CONSTRUCTION

REV	DATE	REVISION DETAIL	DRN	CHKD	APPV	REV	DATE	DRAWING NUMBER	REFERENCE DRAWING TITLE
B	19/02/2020	Updated after Internal Review	LZ						
B	17/02/2020	Updated after Internal Review	LZ	BM			19/02/2020		
A	07/01/2020	Issued for Internal Review	KM	BM			17/02/2020		

**METS ENGINEERING**  
PROCESS + INNOVATION

Resource Projects · Technology  
Integrated Services

L3, 44 Parliament Place, West Perth 6005  
PO BOX 1699, West Perth 6872

CLIENT: **DEEP SOUTH Resources Inc.**

PROJECT: **Haib Heap Leach Project**

DRAWN	SIGNED	DATE	TITLE:
KM		07/01	<b>Copper Processing -20 Mtpa</b>
CHECKED	SIGNED	DATE	
DESIGNED	SIGNED	DATE	
VERIFIED	SIGNED	DATE	
CLIENT APP.	SIGNED	DATE	

Eq. No.:  
AREA: 400  
SHEET 3 OF 4

DRAWING NO. **J5329-P-PFD-400-003**

DO NOT SCALE	WEIGHT ~ KG	SCALE 1:1	SHEET A3
AREA No.	PROJECT No.	REV C	

© THIS DRAWING IS THE PROPERTY OF M.E.T.S. P/L AND SHALL NOT BE USED OR REPRODUCED WITHOUT THE EXPRESS WRITTEN CONSENT OF THE CORPORATION

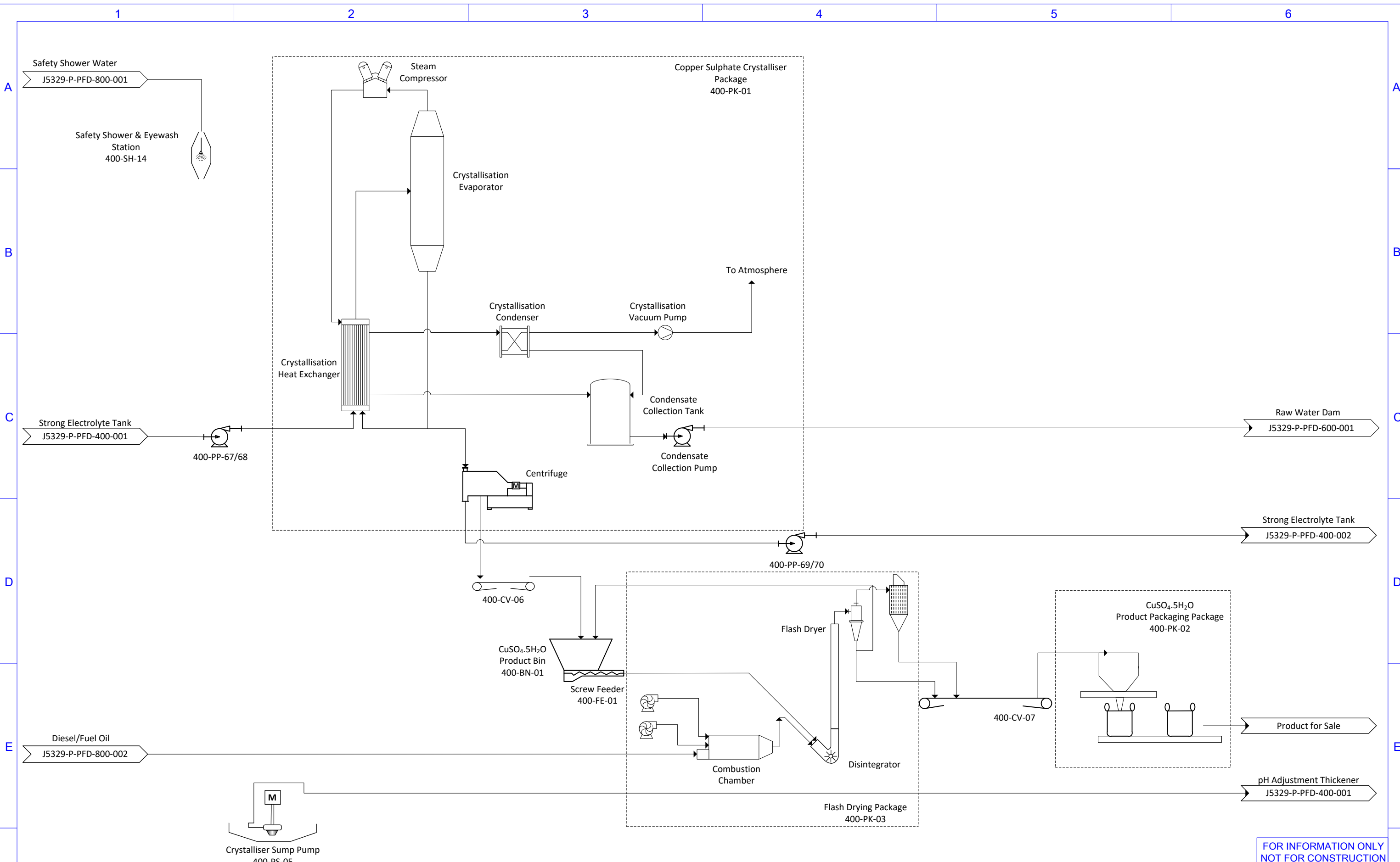

FOR INFORMATION ONLY  
NOT FOR CONSTRUCTION

REV	DATE	REVISION DETAIL	DRN	CHKD	APPV	REV	DATE	DRAWING NUMBER	REFERENCE DRAWING TITLE
A	04/03/2020	Issued for Internal Review	LZ						

**METS ENGINEERING**  
PROCESS + INNOVATION

Resource Projects · Technology  
Integrated Services

L3, 44 Parliament Place, West Perth 6005  
PO BOX 1699, West Perth 6872

CLIENT: **DEEP SOUTH Resources Inc.**

PROJECT: **Haib Heap Leach Project**

DRAWN	SIGNED	DATE
KM		07/01
CHECKED	SIGNED	DATE
DESIGNED	SIGNED	DATE
VERIFIED	SIGNED	DATE
CLIENT APP.	SIGNED	DATE

TITLE: **Copper Processing - 20 Mtpa**

Eq. No.:  
AREA: 400  
SHEET 4 OF 4

DRAWING NO. **J5329-P-PFD-400-004**

DO NOT SCALE

WEIGHT ~ KG	SCALE 1:1	SHEET A3
AREA No.	PROJECT No.	REV A

© THIS DRAWING IS THE PROPERTY OF M.E.T.S. P/L AND SHALL NOT BE USED OR REPRODUCED WITHOUT THE EXPRESS WRITTEN CONSENT OF THE CORPORATION

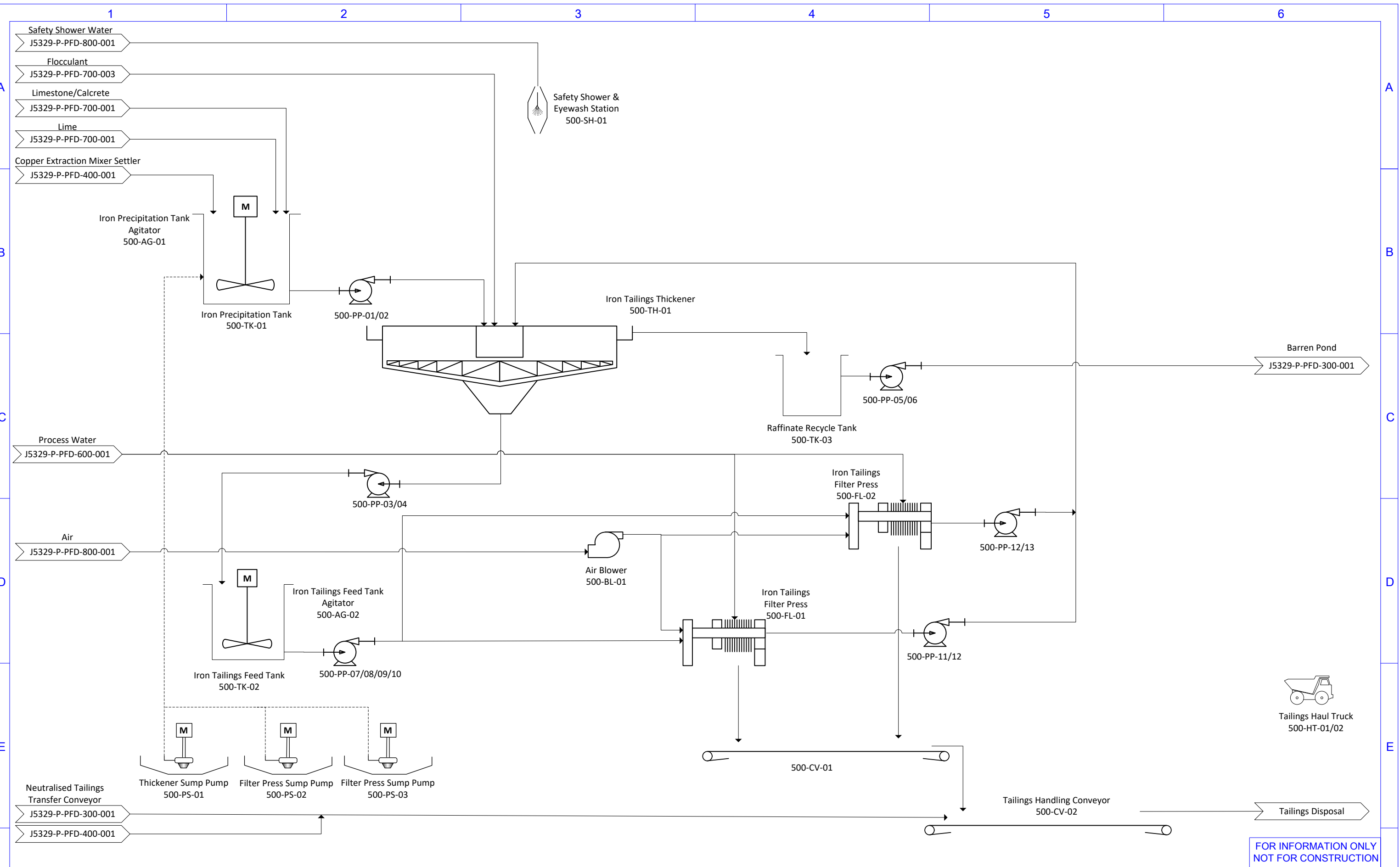

FOR INFORMATION ONLY  
NOT FOR CONSTRUCTION

REV	DATE	REVISION DETAIL	DRN	CHKD	APPV	REV	DATE	DRAWING NUMBER	REFERENCE DRAWING TITLE
C	19/02/2020	Updated after Internal Review							
B	17/02/2020	Updated after Internal Review	LZ	BM			19/02/2020		
A	07/01/2020	Issued for Internal Review	KM	BM			17/02/2020		

**METS ENGINEERING**  
PROCESS + INNOVATION

Resource Projects · Technology  
Integrated Services

L3, 44 Parliament Place, West Perth 5005  
PO BOX 1699, West Perth 6872

CLIENT: **DEEP SOUTH Resources Inc.**

PROJECT: **Haib Heap Leach Project**

DRAWN	SIGNED	DATE	TITLE:
KM		07/01	<b>Iron Removal</b>
CHECKED	SIGNED	DATE	
DESIGNED	SIGNED	DATE	
VERIFIED	SIGNED	DATE	
CLIENT APP.	SIGNED	DATE	
Eq. No.: AREA: 500 SHEET 1 OF 1			DO NOT SCALE
DRAWING NO. J5329-P-PFD-500-001			
WEIGHT ~ KG	SCALE 1:1	SHEET A3	AREA No. PROJECT No. REV C

A B C D E F

F

F



© THIS DRAWING IS THE PROPERTY OF M.E.T.S. P/L AND SHALL NOT BE USED OR REPRODUCED WITHOUT THE EXPRESS WRITTEN CONSENT OF THE CORPORATION

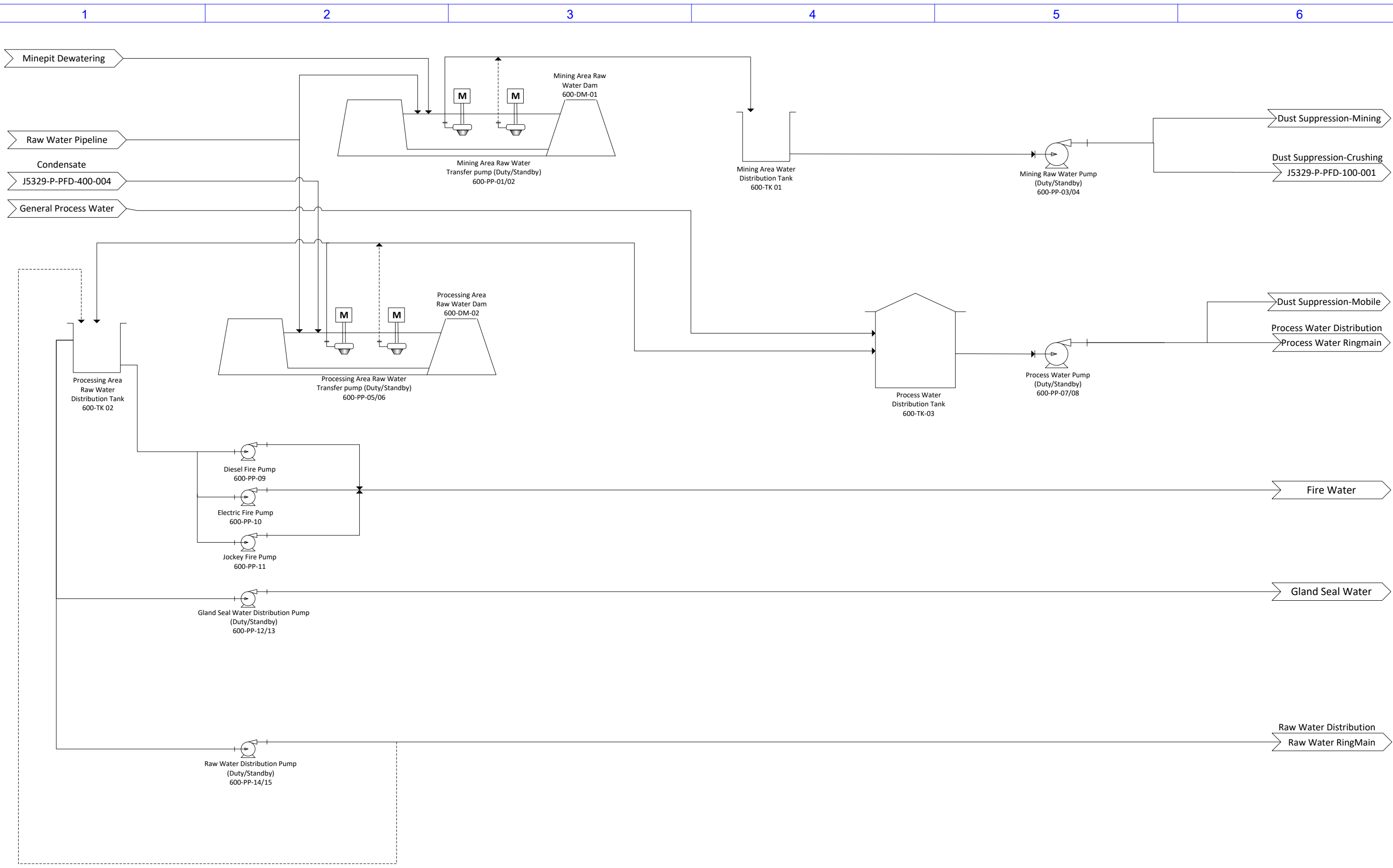

FOR INFORMATION ONLY  
NOT FOR CONSTRUCTION

REV	DATE	REVISION DETAIL	DRN	CHKD	APPV	REV	DATE	DRAWING NUMBER	REFERENCE DRAWING TITLE
B	19/02/2020	Updated after Internal Review	LZ						
A	07/01/2020	Issued for Internal Review	KM	BM		17/02/2020			

**METS ENGINEERING**  
PROCESS + INNOVATION

Resource Projects · Technology  
Integrated Services

L3, 44 Parliament Place, West Perth 6005  
PO BOX 1699, West Perth 6872

CLIENT: **DEEP SOUTH Resources Inc.**

PROJECT: **Haib Heap Leach Project**

DRAWN	SIGNED	DATE
KM		07/01
CHECKED	SIGNED	DATE
DESIGNED	SIGNED	DATE
VERIFIED	SIGNED	DATE
CLIENT APP.	SIGNED	DATE

TITLE: **Process and Raw Water**

Eq. No.:  
AREA:600  
SHEET 1 OF 1

DRAWING NO. **J5329-P-PFD-600-001**

DO NOT SCALE		
WEIGHT ~ KG	SCALE 1:1	SHEET A3
AREA No.	PROJECT No.	REV B

1

2

3

4

5

6

F

© THIS DRAWING IS THE PROPERTY OF M.E.T.S. P/L AND SHALL NOT BE USED OR REPRODUCED WITHOUT THE EXPRESS WRITTEN CONSENT OF THE CORPORATION

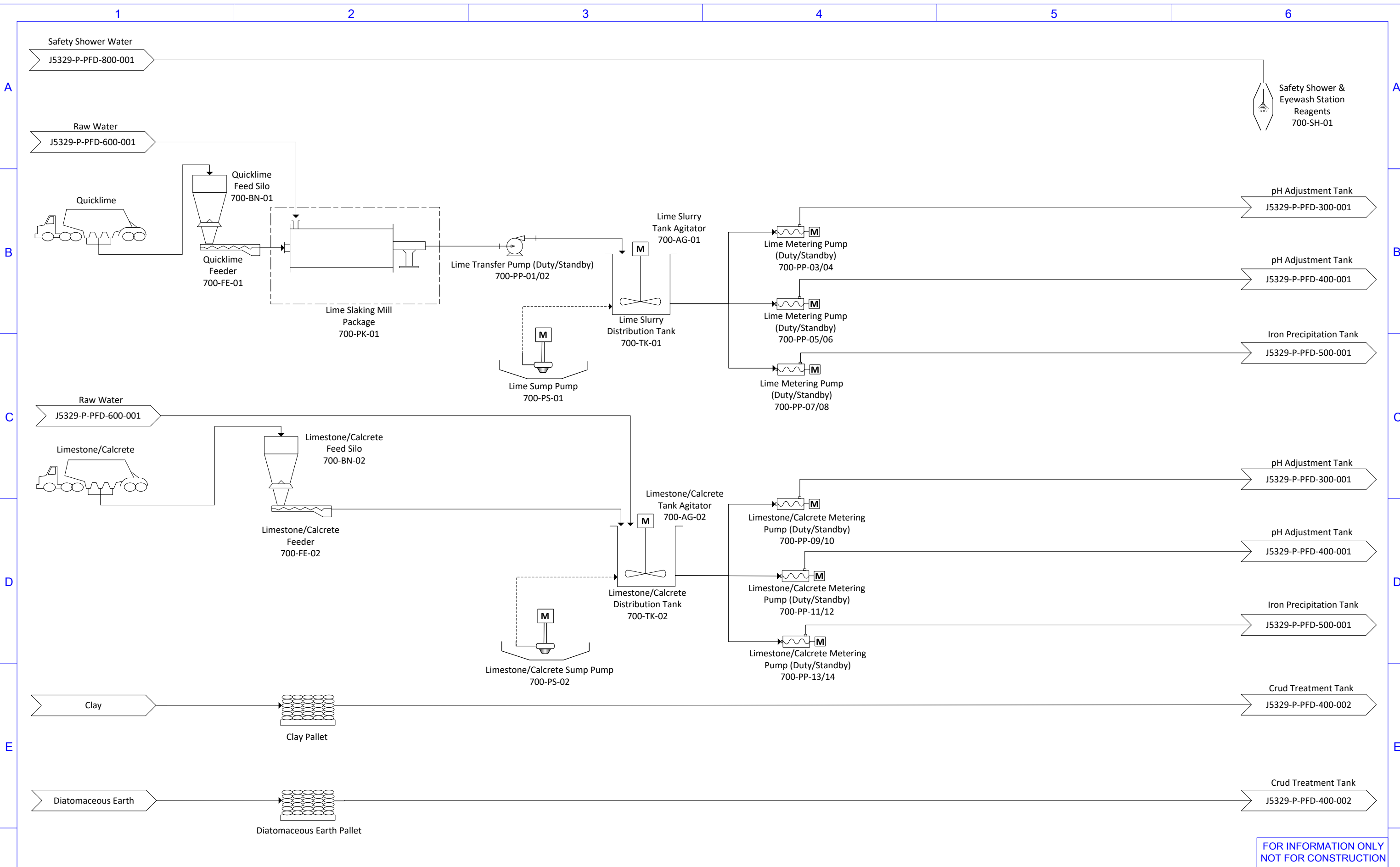

REV	DATE	REVISION DETAIL	DRN	CHKD	APPV	REV	DATE	DRAWING NUMBER	REFERENCE DRAWING TITLE
C	19/02/2020	Updated after internal Review	LZ						
B	17/02/2020	Updated after internal Review	LZ	BM			19/02/2020		
A	07/01/2020	Issued for Internal Review	KM	BM			17/02/2020		

**METS ENGINEERING**  
PROCESS + INNOVATION

Resource Projects · Technology  
Integrated Services

L3, 44 Parliament Place, West Perth 6005  
PO BOX 1699, West Perth 6872

CLIENT: **DEEP SOUTH Resources Inc.**

PROJECT: **Haib Heap Leach Project**

DRAWN KM	SIGNED	DATE 07/01	<b>Reagents</b> Eq. No.: AREA: 700 SHEET 1 OF 3 DRAWING NO. J5329-P-PFD-700-001	 DO NOT SCALE	
CHECKED	SIGNED	DATE			
DESIGNED	SIGNED	DATE			
VERIFIED	SIGNED	DATE			
CLIENT APP.	SIGNED	DATE			
WEIGHT - KG	SCALE 1:1	SHEET A3	AREA No.	PROJECT No.	REV C

© THIS DRAWING IS THE PROPERTY OF M.E.T.S. P/L AND SHALL NOT BE USED OR REPRODUCED WITHOUT THE EXPRESS WRITTEN CONSENT OF THE CORPORATION

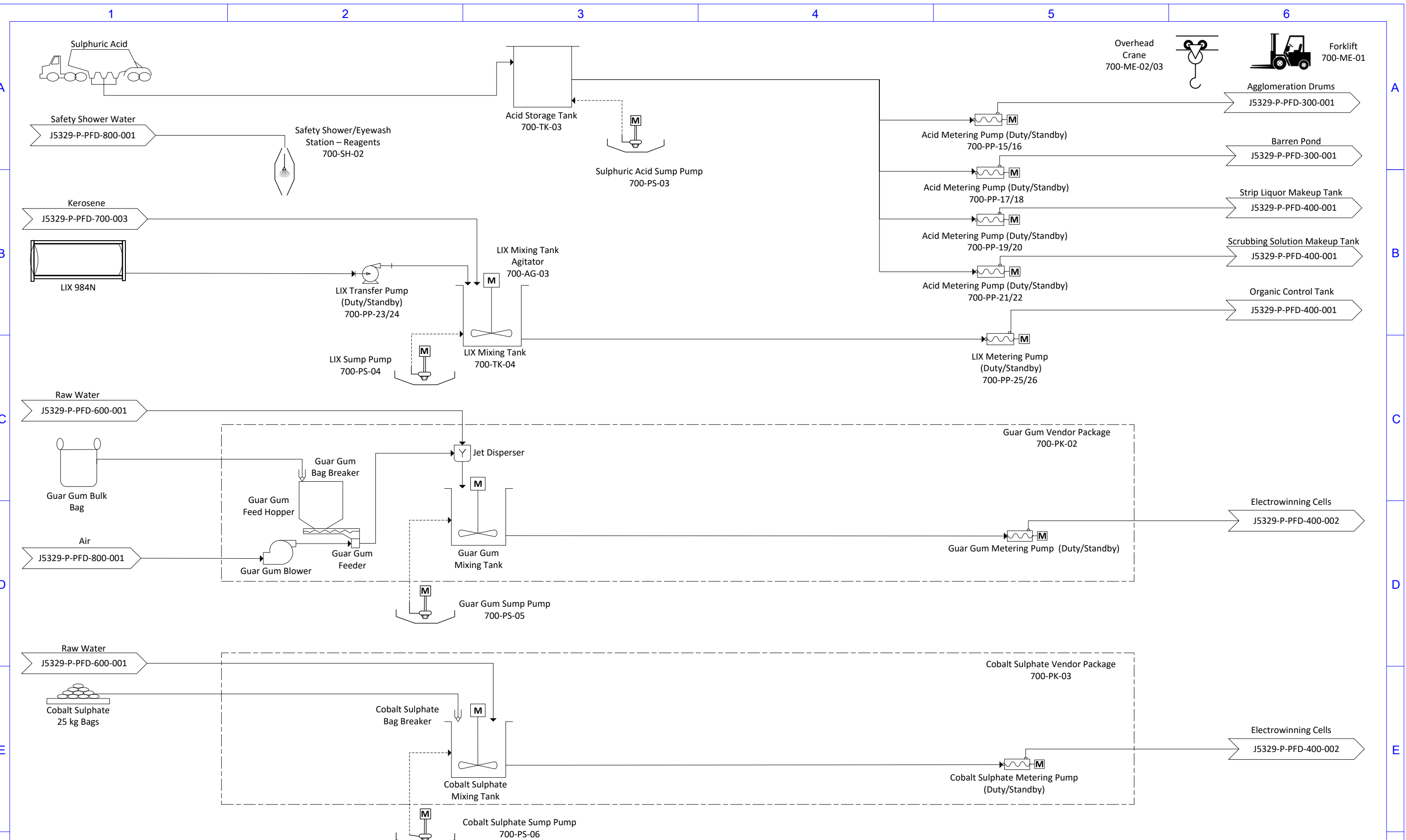

FOR INFORMATION ONLY  
NOT FOR CONSTRUCTION

REV	DATE	REVISION DETAIL	DRN	CHKD	APPV	REV	DATE	DRAWING NUMBER	REFERENCE DRAWING TITLE
C	19/02/2020	Updated after internal Review	LZ						
B	17/02/2020	Updated after internal Review	LZ	BM			19/02/2020		
A	07/01/2020	Issued for Internal Review	KM	BM			17/02/2020		

**METS ENGINEERING**  
PROCESS + INNOVATION

Resource Projects · Technology  
Integrated Services

L3, 44 Parliament Place, West Perth 6005  
PO BOX 1699, West Perth 6872

CLIENT: **DEEP SOUTH Resources Inc.**

PROJECT: **Haib Heap Leach Project**

DRAWN	SIGNED	DATE	TITLE:
KM		07/01	<b>Reagents</b>
CHECKED	SIGNED	DATE	
DESIGNED	SIGNED	DATE	
VERIFIED	SIGNED	DATE	
CLIENT APP.	SIGNED	DATE	

Eq. No.: AREA:700  
SHEET 2 OF 3

DRAWING NO. **J5329-P-PFD-700-002**

DO NOT SCALE	WEIGHT ~ KG	SCALE 1:1	SHEET A3
AREA No.	PROJECT No.	REV C	

F

© THIS DRAWING IS THE PROPERTY OF M.E.T.S. P/L AND SHALL NOT BE USED OR REPRODUCED WITHOUT THE EXPRESS WRITTEN CONSENT OF THE CORPORATION

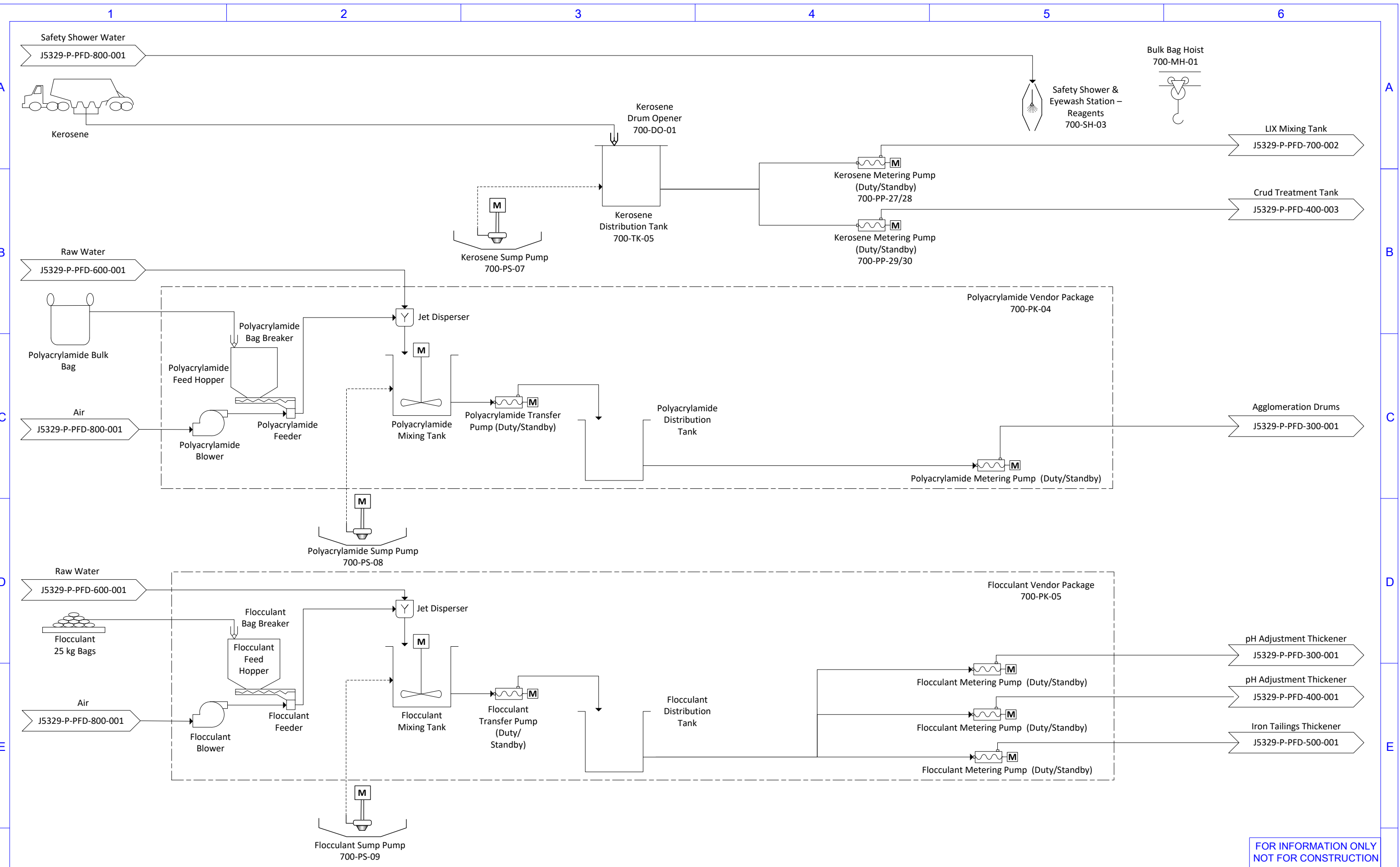

FOR INFORMATION ONLY  
NOT FOR CONSTRUCTION

REV	DATE	REVISION DETAIL	DRN	CHKD	APPV	REV	DATE	DRAWING NUMBER	REFERENCE DRAWING TITLE
C	19/02/2020	Updated after internal Review	LZ						
B	17/02/2020	Updated after internal Review	LZ	BM			19/02/2020		
A	07/01/2020	Issued for Internal Review	KM	BM			17/02/2020		

**METS ENGINEERING**  
PROCESS + INNOVATION

Resource Projects · Technology  
Integrated Services

L3, 44 Parliament Place, West Perth 6005  
PO BOX 1699, West Perth 6872

CLIENT: **DEEP SOUTH Resources Inc.**

PROJECT: **Haib Heap Leach Project**

DRAWN KM	SIGNED	DATE 07/01	<b>Reagents</b> Eq. No.: AREA:700 SHEET 3 OF 3 DRAWING NO. J5329-P-PFD-700-003	 DO NOT SCALE
CHECKED	SIGNED	DATE		
DESIGNED	SIGNED	DATE		
VERIFIED	SIGNED	DATE		
CLIENT APP.	SIGNED	DATE		

WEIGHT ~ KG SCALE 1:1 SHEET A3

AREA No. PROJECT No. REV C

© THIS DRAWING IS THE PROPERTY OF M.E.T.S. P/L AND SHALL NOT BE USED OR REPRODUCED WITHOUT THE EXPRESS WRITTEN CONSENT OF THE CORPORATION

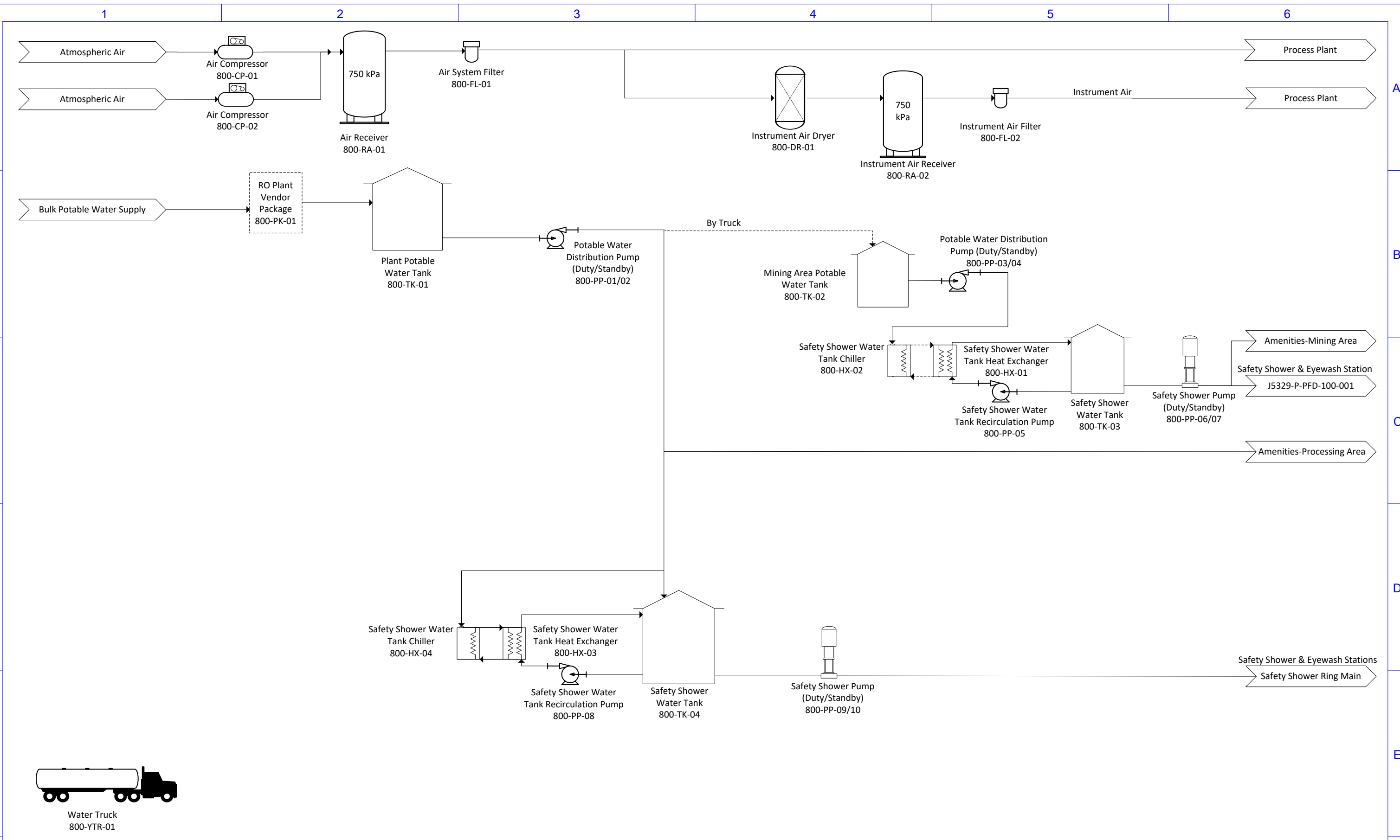

FOR INFORMATION ONLY  
NOT FOR CONSTRUCTION

REV	DATE	REVISION DETAIL	DRN	CHKD	APPV	REV	DATE	DRAWING NUMBER	REFERENCE DRAWING TITLE
B	19/02/2020	Updated after Internal Review	LZ						
A	07/01/2020	Issued for Internal Review	KM	BM		19/02/2020			

**METS ENGINEERING**  
PROCESS + INNOVATION

Resource Projects · Technology  
Integrated Services

L3, 44 Parliament Place, West Perth 6005  
PO BOX 1699, West Perth 6872

CLIENT: **DEEP SOUTH Resources Inc.**

PROJECT: **Haib Heap Leach Project**

DRAWN	SIGNED	DATE	TITLE:
KM		07/01	Services Eq. No.: AREA:800 SHEET 1 OF 2 DRAWING NO. J5329-P-PFD-800-001
CHECKED	SIGNED	DATE	
DESIGNED	SIGNED	DATE	
VERIFIED	SIGNED	DATE	
CLIENT APP.	SIGNED	DATE	

DO NOT SCALE	
WEIGHT ~ KG	SCALE 1:1 SHEET A3
AREA No.	PROJECT No. REV B

1 2 3 4 5 6

© THIS DRAWING IS THE PROPERTY OF M.E.T.S. P/L AND SHALL NOT BE USED OR REPRODUCED WITHOUT THE EXPRESS WRITTEN CONSENT OF THE CORPORATION

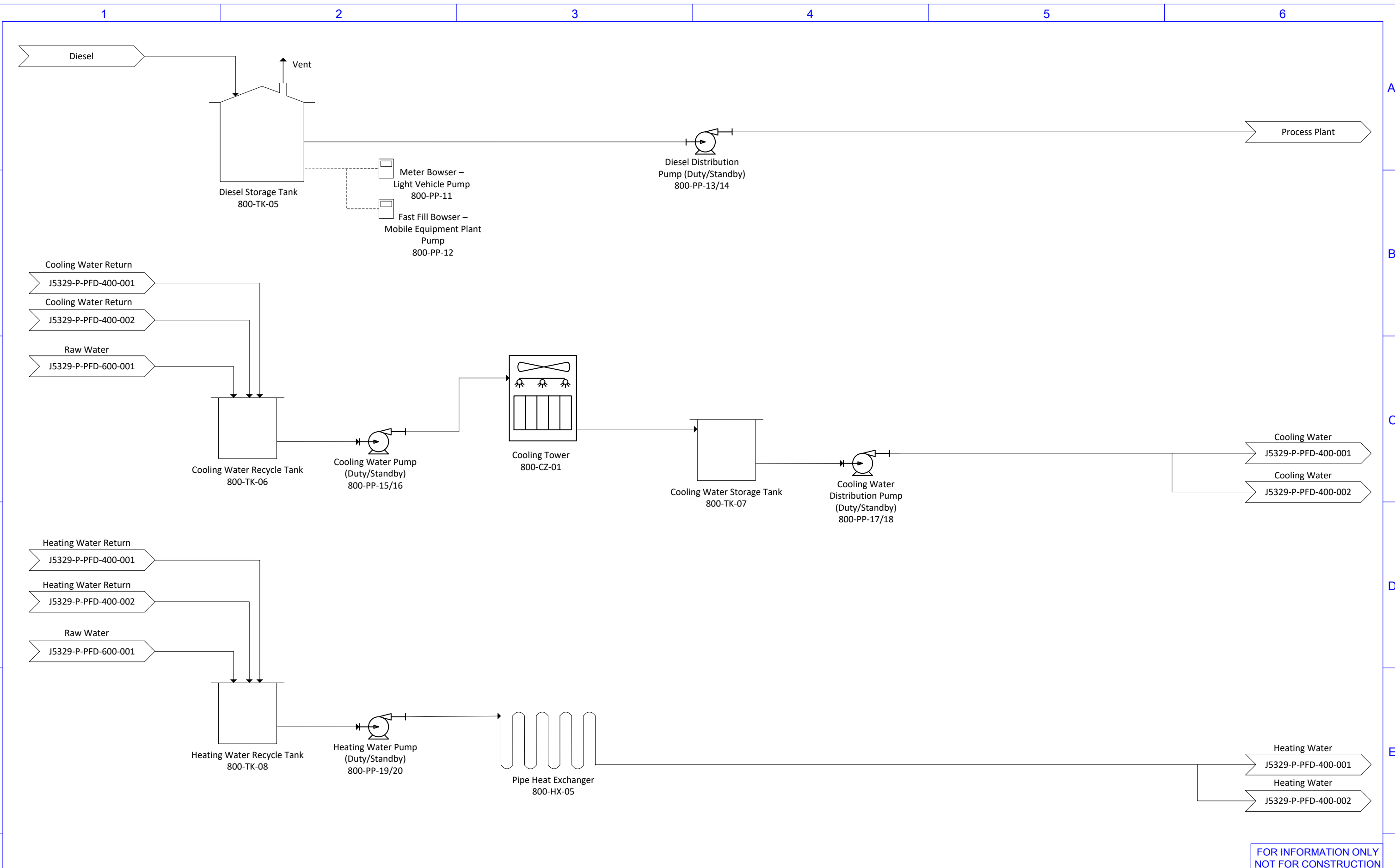

FOR INFORMATION ONLY  
NOT FOR CONSTRUCTION

REV	DATE	REVISION DETAIL	DRN	CHKD	APPV	REV	DATE	DRAWING NUMBER	REFERENCE DRAWING TITLE
B	19/02/2020	Updated after Internal Review	LZ						
A	07/01/2020	Issued for Internal Review	KM	BM		19/02/2020			

**METS ENGINEERING**  
PROCESS + INNOVATION

Resource Projects · Technology  
Integrated Services

L3, 44 Parliament Place, West Perth 6005  
PO BOX 1699, West Perth 6872

CLIENT: **DEEP SOUTH Resources Inc.**

PROJECT: **Haib Heap Leach Project**

DRAWN	SIGNED	DATE	TITLE:
KM		07/01	Services Eq. No.: AREA:800 SHEET 2 OF 2 DRAWING NO. J5329-P-PFD-800-002
CHECKED	SIGNED	DATE	
DESIGNED	SIGNED	DATE	
VERIFIED	SIGNED	DATE	
CLIENT APP.	SIGNED	DATE	

DO NOT SCALE		
WEIGHT ~ KG	SCALE 1:1	SHEET A3
AREA No.	PROJECT No.	REV A





**Prepared for: Deep-South Resources Inc.**  
**Haib Copper Project**  
**PEA Update – Process Description**

CONFIDENTIAL

Project No: J5329

Date: 30/04/2020

***Submitted by:***

Damian Connelly  
Principal Consulting Engineer  
Chartered Professional Engineer  
Email: [damian.connelly@metsengineering.com](mailto:damian.connelly@metsengineering.com)

METS Engineering Group Pty Ltd  
PO Box 1699  
West Perth WA 6872  
P: (+61 8) 9421 9000  
ABN 92 625 467 674

W: [www.metsengineering.com](http://www.metsengineering.com)  
E: [info@metsengineering.com](mailto:info@metsengineering.com)



## CONFIDENTIALITY

This document and its contents, including work scope, methodology and commercial terms will be treated in strict confidence by **Deep-South Resources Inc.** and the contents will be used by **Deep-South Resources Inc.** only for their own use.

Passing of this document to a third party, duplication or re-use of this document, in whole or part, electronically or otherwise, is not permitted without the expressed written consent of METS Engineering Group Pty Ltd.

## DISCLAIMER

With respect to all the information contained herein, neither METS Engineering Group Pty Ltd, nor any officer, servant, employee, agent or consultant thereof make any representations or give any warranties, expressed or implied, as to the accuracy, reliability or completeness of the information contained herein, including but not limited to opinions, information or advice which may be provided to users of the document.

No responsibility is accepted to users of this document for any consequence of relying on the contents hereof.

J5329 – DEEP-SOUTH RESOURCES INC.							
REV	DESCRIPTION	ORIG	REVIEW	APPROVAL	DATE	CLIENT APPROVAL	DATE
A	Issued For Internal Review	LZ			30/01/2020		
	Issued For Internal Review						

## Table of Contents

1.	Introduction .....	1
1.1	Project Location .....	1
1.2	Resources .....	2
1.3	Previous Testwork .....	2
2.	WHOLE ORE HEAP LEACHING .....	3
2.1	Crushing and Ore Handling .....	3
2.1.1	Crushing – 8.5 Mtpa .....	3
2.1.2	Crushing – 20 Mtpa .....	3
2.2	Tertiary Crushing .....	4
2.2.1	Tertiary Crushing – 8.5 Mtpa .....	4
2.2.2	Tertiary Crushing – 20 Mtpa .....	5
2.3	Agglomeration Drum .....	5
2.4	Heap Leach .....	6
2.4.1	Stacking .....	6
2.4.2	Irrigation .....	8
2.4.3	Liner System .....	8
2.4.4	Protection Layer .....	8
2.4.5	Heating System .....	9
2.4.6	Heap Air Injection .....	9
2.4.7	Heap Layout .....	10
2.4.8	Primary Heap .....	10
2.4.9	Secondary Heap .....	10
2.4.10	Washing Heap .....	11
2.5	Crud Removal System .....	11
2.6	Crud Treatment .....	11
2.7	Copper Solvent Extraction/Electrowinning .....	12
2.8	Iron and Aluminium Precipitation .....	14
2.9	Metallurgical Accounting .....	16
2.9.1	Data Collection .....	16
2.10	Water Distribution .....	17
2.10.1	Raw Water .....	17
2.10.2	Spillages and Storm Water .....	17

2.11	REAGENTS AND CONSUMABLES .....	17
2.11.1	Quicklime.....	17
2.11.2	Limestone/Calcrete.....	18
2.11.3	Clay .....	18
2.11.4	Diatomaceous Earth .....	18
2.11.5	Sulphuric Acid .....	18
2.11.6	LIX984N .....	18
2.11.7	Guar Gum.....	19
2.11.8	Cobalt Sulphate.....	19
2.11.9	Kerosene .....	19
2.11.10	Polyacrylamide .....	19
2.11.11	Flocculant.....	20
2.12	SERVICES .....	20
2.12.1	Air.....	20
2.12.2	Potable Water.....	21
2.12.3	Diesel .....	21
2.12.4	Cooling Water.....	21
2.12.5	Heating Water .....	21

## LIST OF FIGURES

Figure 1-1-1:	Location of the Haib Deposit .....	1
Figure 1-2:	Heap Leach Route for Copper Production .....	2
Figure 2-1:	Heap Stacking via Conveyors .....	7
Figure 2-2:	Drip Line Irrigation Method .....	8
Figure 2-3:	Leak Detection System .....	9
Figure 2-4:	Forced Aeration System.....	10
Figure 2-5:	Heap Design.....	10

## 1. INTRODUCTION

METS Engineering Group (METS) has developed a Process Description for whole ore heap leaching processing option identified for the Haib Copper Project. The Process Description document is to be read in conjunction with the Process Flow Diagrams (PFD).

### 1.1 Project Location

The Haib copper deposit is located in the extreme south of Namibia close to the border with South Africa which is defined by the Orange River. The deposit lies 12-15 kilometres off the main interstate highway connecting South Africa and Namibia as shown in Figure 1-1-1. The nearest railway station is at Grunau 120 km north of the main highway. This rail connection could provide access to the port of Luderitz or Walvis Bay via Windhoek.



**Figure 1-1-1: Location of the Haib Deposit**

## 1.2 Resources

The Haib Copper Deposit is a large copper-molybdenum porphyry deposit. Copper is mainly present as a sulphide in the form of chalcopyrite, with a small presence of oxides. The dominant copper mineral at Haib is chalcopyrite ( $\text{CuFeS}_2$ ) with minor amounts of bornite, chalcocite and various copper oxides (chrysocolla, plancheite, malachite and azurite). The measured and indicated resource at a 0.25% copper cut-off grade gives 456.9 Mt of ore at 0.31% copper and 46 ppm molybdenum.

## 1.3 Previous Testwork

A past study on BioHeap leaching of Haib ore gave maximum recoveries of iron and copper of 9.2%, 95.2% respectively with 93% sulphide oxidation.

Heap leaching is found to be an attractive option due to the deposit being significantly large with a relatively low copper grade. At present there are two methods employed worldwide to process copper ores for metal production:

1. Pyrometallurgical method: crushing, grinding, flotation, smelting-refining and electro-refining. This is applied to sulphide flotation concentrates and is only feasible for copper rich ores.
2. Hydrometallurgical: crushing, leaching (non-oxidative leaching, atmospheric leaching and pressure leaching), solvent extraction and electrowinning. The Heap Leach/dumping route is illustrated in Figure 1-2.

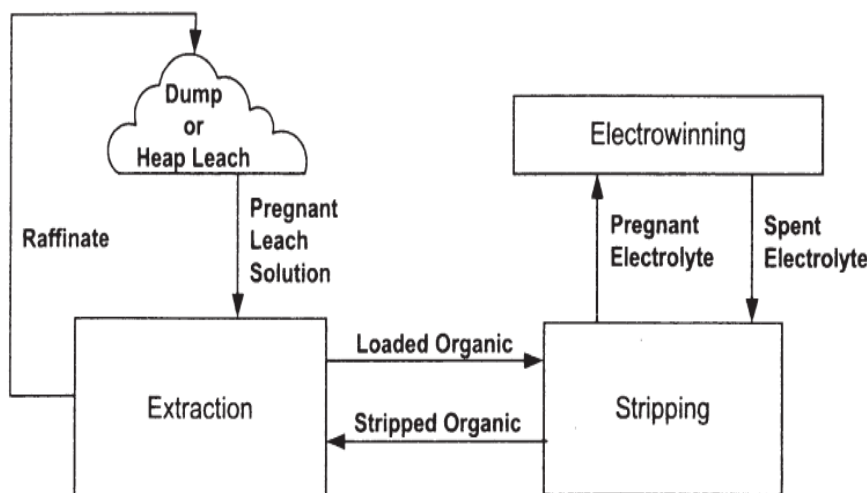

**Figure 1-2: Heap Leach Route for Copper Production**

## **2. WHOLE ORE HEAP LEACHING**

### **2.1 Crushing and Ore Handling**

#### **2.1.1 Crushing – 8.5 Mtpa**

Run of Mine (ROM) ore is transported by truck from the mine to the ROM stockpile area near the crushing plant. The material is transferred to a ROM bin (100-BN-01), which feeds to a primary crusher. The primary crusher is a gyratory crusher (100-CR-01) suited to higher crushing capacities. The closed side setting (OSS) of the gyratory crusher is expected to be set at 160 mm with an assumed  $P_{80}$  of 137 mm to be produced. The output of the gyratory crusher is discharged into a surge vault (100-SV-01) where it will be directed to a primary crusher discharge conveyor (100-CV-01) via an apron feeder (100-FE-01). The gyratory crusher product is then transferred to a diverter chute (100-CH-01) which will distribute the material into two streams that feed two cone crushers feed bins (100-BN-02/03) in parallel.

The cone crusher feed bins discharge will go to the cone crusher vibrating feeders (100-FE-02/03) then into the cone crushers (100-CR-02/03). The cone crushers closed side setting (CSS) is 32 mm, with an expected product  $P_{80}$  of 40 mm. The cone crusher product will be fed to a screen (100-SC-01) in which the oversize is directed to the primary crusher discharge conveyor and recycled to cone crusher feed bins whilst the undersize is conveyed to a crushed ore stockpile via a screen undersize discharge conveyor (100-CV-05).

The crushed ore stockpile is conveyed to a HPGR Feed stockpile locating at the processing plant by a long distance conveyor (100-CV-08).

#### **2.1.2 Crushing – 20 Mtpa**

Run of Mine (ROM) ore is transported by truck from the mine and is discharged into a ROM bin (100-BN-01), which feeds to a primary crusher. The primary crusher is a gyratory crusher (100-CR-01) suited to higher crushing capacities. The closed side setting (OSS) of the gyratory crusher is expected to be set at 177 mm with an assumed  $P_{80}$  of 150 mm to be produced. The output of the gyratory crusher is discharged into a surge vault (100-SV-01) where it will be directed to a primary

crusher discharge conveyor (100-CV-01) via an apron feeder (100-FE-01). The gyratory crusher product is then transferred to a tripper feed conveyor (100-TP-01) which will distribute the material into five streams that feed five cone crushers feed bins (100-BN-02/03/04/05/06) in parallel.

The cone crusher feed bins discharge will go to the cone crusher vibrating feeders (100-FE-02/03/04/05/06) then into the cone crushers (100-CR-02/03/04/05/06). The cone crushers closed side setting (CSS) is 25 mm, with an expected product  $P_{80}$  of 31 mm. The cone crusher product will be fed to three screens (100-SC-01/02/03) in which the oversize is directed to the primary crusher discharge conveyor and recycled to cone crusher feed bins whilst the undersize is conveyed to a crushed ore stockpile via a screen undersize discharge conveyor (100-CV-08).

The crushed ore stockpile is conveyed to a HPGR Feed stockpile locating at the processing plant by a long distance conveyor (100-CV-11).

## **2.2 Tertiary Crushing**

### **2.2.1 Tertiary Crushing – 8.5 Mtpa**

The stockpiled ore is reclaimed via apron feeders (200-FE-01/02) and stockpile discharge conveyors (200-CV-01/02). The ore is then transferred via the HPGR feed conveyor (200-CV-03) and is discharged onto a diverter chute (200-CH-01) to feed the tertiary crushing circuit. The tertiary crushing circuit is consisted of two high pressure grinding rolls (HGPR) (200-GR-01/02) in parallel. The diverter chute (200-CH-01) will distribute the ore into two HPGR feed bins (200-BN-01/02). The HPGRs will then be fed via vibrating feeders (200-FE-03/04).

The HPGR target crush size is 5 mm. The product is in closed circuit with two double deck banana screens (200-SC-01/02) and produces two size fractions. The oversize material is recycled back to the HPGR feed conveyors (200-CV-03) and the undersize fraction stream reports to agglomeration through the screen undersize discharge conveyor (200-CV-07).

HPGR introduces micro-cracking that improves leach kinetics, allowing for maximum metal extraction during the heap leach process.

### 2.2.2 Tertiary Crushing – 20 Mtpa

The stockpiled ore is reclaimed via apron feeders (200-FE-01/02) and stockpile discharge conveyors (200-CV-01/02). The ore is then transferred via the HPGR feed conveyor (200-CV-03) and is discharged onto a diverter chute (200-CH-01) to feed the grinding circuit. The tertiary crushing circuit is consisted of two high pressure grinding rolls (HGPR) (200-GR-01/02) in parallel. The diverter chute (200-CH-01) will distribute the ore into two HPGR feed bins (200-BN-01/02). The HPGRs will then be fed via vibrating feeders (200-FE-03/04).

The HPGR target crush size is 5 mm. The product is in closed circuit with four double deck banana screens (200-SC-01/02/03/04) and produces two size fractions. The oversize material is recycled back to the HPGR feed conveyors (200-CV-03) and the undersize fraction stream reports to agglomeration through the screen undersize discharge conveyor (200-CV-07).

HPGR introduces micro-cracking that improves leach kinetics, allowing for maximum metal extraction during the heap leach process.

## 2.3 Agglomeration Drum

Agglomeration improves the permeability of the heap and facilitates even acid flow without pooling and increasing the amount of oxygen available for reaction. Additionally, pre-wetting will reduce the losses of fines from the wind and increase the leaching kinetics of the ore. Heap leaching requires good percolation throughout the heap to ensure maximum metal recovery is realised. Clays and fine particles can hinder solution flow through the heap, and the ore is often agglomerated to overcome this issue. It is considered essential to undergo agglomeration prior to heap leaching to ensure good metal recovery.

For a plant throughput of 8.5 Mtpa, two rotary drums (300-AD-01/02) will be used. While for a plant throughput of 20 Mtpa, four rotary drums (300-AD-01/02/03/04) will be used.

The HPGR undersize particles will be directed to a agglomerator feed bin (300-BN-01) where it will be discharged onto a agglomerator feed conveyor (300-CV-01) which will feed the agglomeration drums via diverter chute(s) (300-CH-01 for 8.5 Mtpa and 300-CH-01/02/03 for 20 Mtpa).



The undersize particles are combined with binder, sulphuric acid and water to agglomerate the ore into clumps. Polyacrylamide acts as the binder and is added to the agglomeration drum in solution form. Additionally, it is a requirement to add 98% sulphuric acid to pre-leach the chalcopyrite and reduce heap leach times. Only 70% of the required acid (stoichiometric basis) should be added for pH control to ensure iron and copper remain in solution and that it doesn't get wasted on gangue material breakdown. After agglomeration the ore is then transferred onto a heap leach pile.

## **2.4 Heap Leach**

### **2.4.1 Stacking**

The ore will be stacked by grasshopper conveyors and inclined conveyor stackers, producing a heap pile as seen in Figure 2-1. This is a preferred stacking method due to conveyor stacking being able to reduce ore segregation which allows for increased permeability. Due to the use of sulphuric acid the conveyor edges must be moulded, open edge belts will severely corrode. Additionally, it is preferable to splice the conveyor belt instead of using clips as it reduces spillage and belt stress.

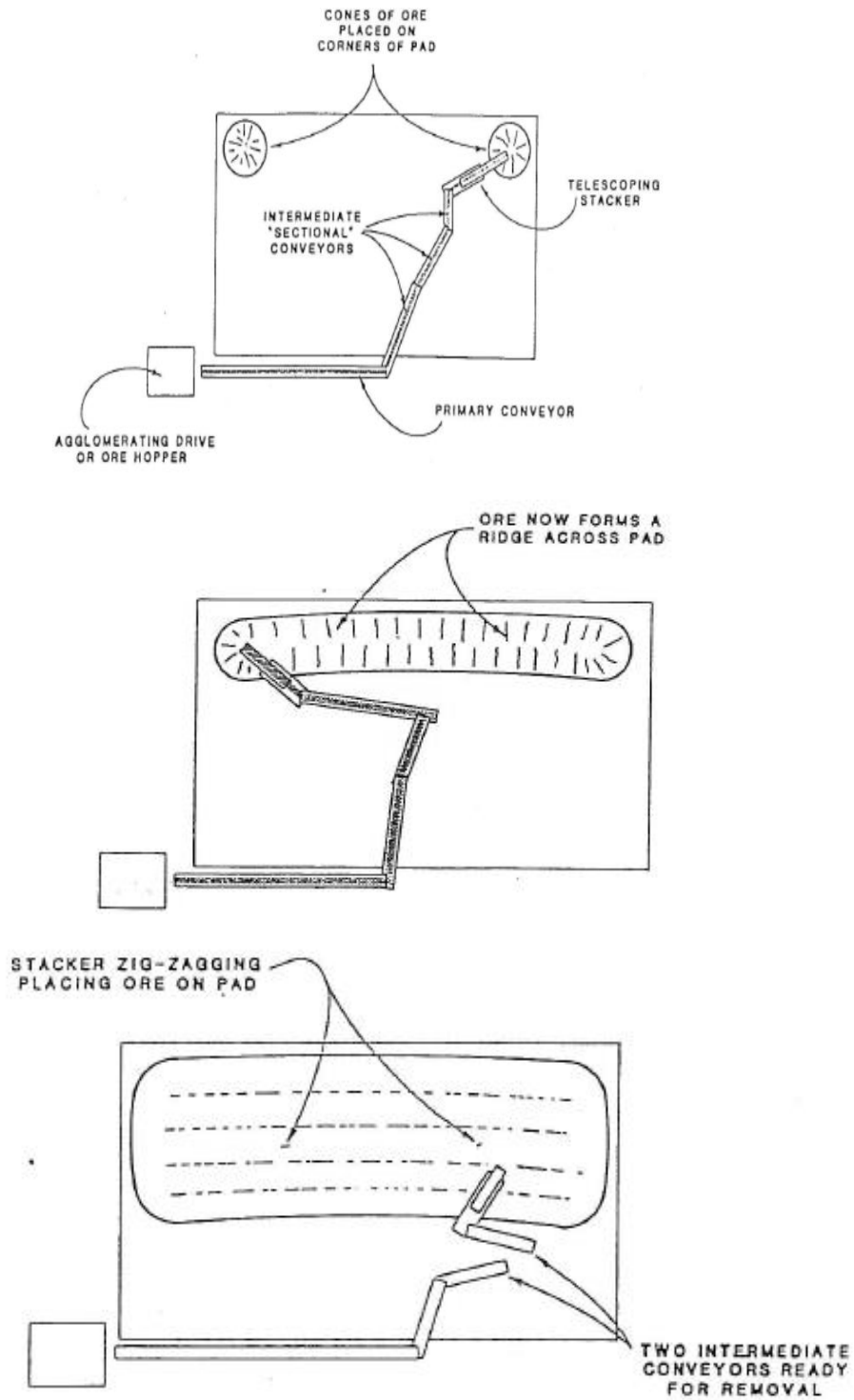

**Figure 2-1: Heap Stacking via Conveyors**

### 2.4.2 Irrigation

Drip lines (Figure 2-2) are used primarily in arid environments due to the substantially reduced evaporation in comparison to heap sprays. The drip lines are buried 10 cm to 50 cm beneath the surface of the heap to minimise evaporation. The lines are used to irrigate the heap with raffinate from the barren solution pond. The irrigation rate will be approximately 10 L/h/m<sup>2</sup>. The primary heap pad will be irrigated with solution from the intermediate leach solution (ILS) pond (300-PD-02). The secondary and the wash heap pad will be irrigated with solution from the barren pond (300-PD-01).

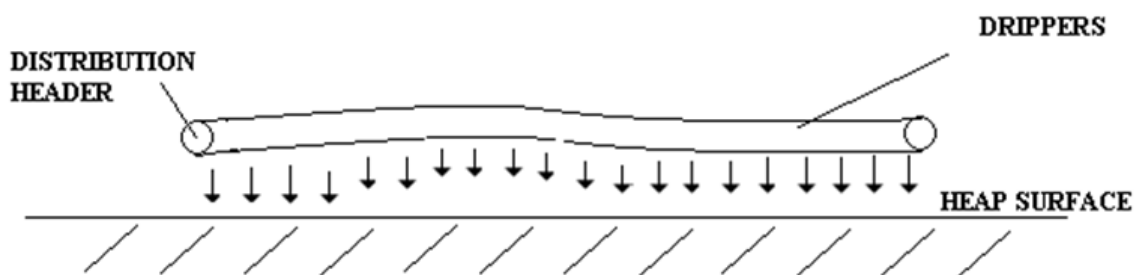

**Figure 2-2: Drip Line Irrigation Method**

### 2.4.3 Liner System

The pad will require a double liner (HDPE) to minimise any possible loss of liquid from liner punctures. There will be an initial ground preparation and liner protection measure put in place before stacking. High density polyethylene geomembrane liners are used due to their high tensile strength and high stress crack resistance. A leakage detection system will be put in place in between the liners as seen in Figure 2-3 which will indicate when a leak has occurred.

### 2.4.4 Protection Layer

Due to the high evaporation rate in the area and close proximity of a river, there is a strict need to minimise risk of the heap solution entering the environment. A compacted impermeable clay layer is common practice to eliminate solution loss. This will be used in conjunction with necessary leakage detection systems to identify any breakages of the liner system so the issue can be resolved promptly.

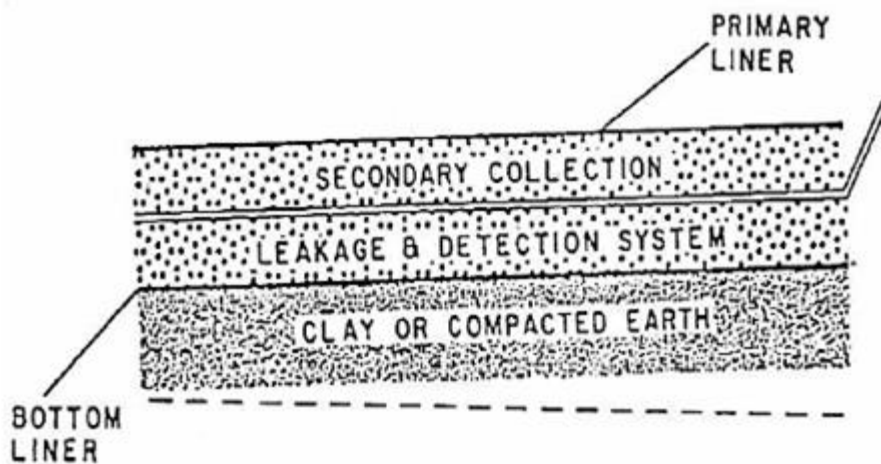

**Figure 2-3: Leak Detection System**

### 2.4.5 Heating System

For effective bacterial heap leaching of the chalcopyrite ore, the temperature inside the heap will need to be maintained at about 65 °C. Although the activities of bacterial inside the heap will generate heat, heating system is included in the heap leaching design to ensure the temperature requirement is met. The Haib Copper Project is located in Namibia where sufficient solar energy can be used for heating purpose. The irrigation solution from the barren pond (300-PD-01) and ILS pond (300-PD-02) will be heated by pipe heat exchangers (300-HX-01/02/03) before feeding to the leaching pads. The pipe heat exchangers will heat up the irrigation solution by converting solar energy into heat. The number of pipe heat exchangers used can be modified based on the heat requirement and solution feed rate.

### 2.4.6 Heap Air Injection

The bacterial heap leaching process will require sufficient air/oxygen for better leaching rate. Forced aeration system as shown in Figure 2-4 is used in the heap design to ensure that the oxygen level is maintained at the desired level.

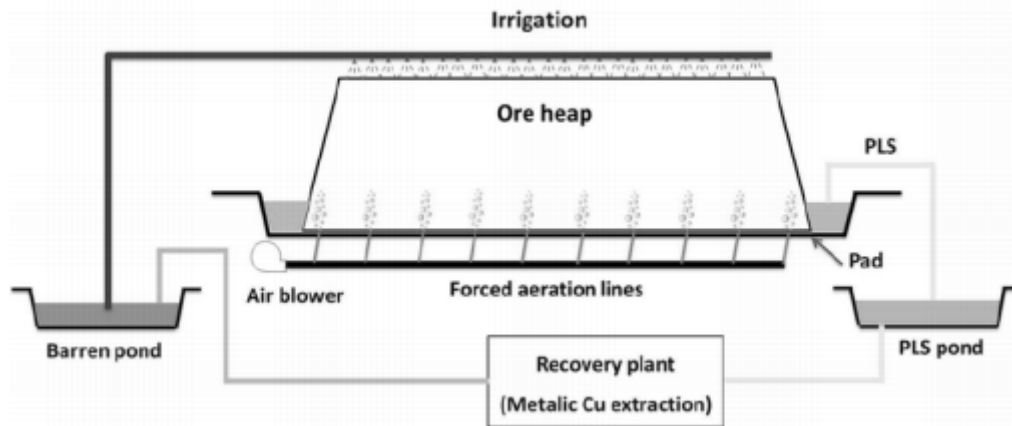

Figure 2-4: Forced Aeration System

### 2.4.7 Heap Layout

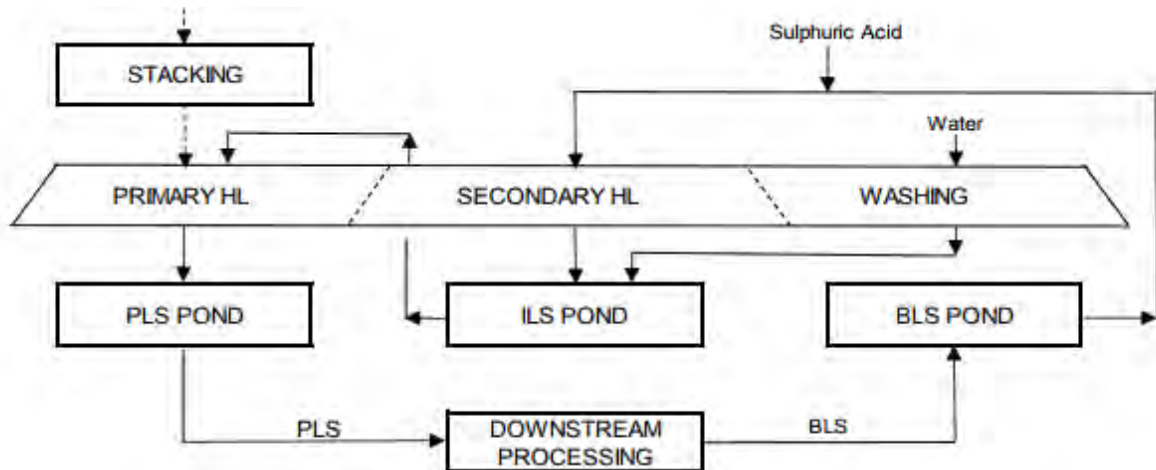

Figure 2-5: Heap Design

### 2.4.8 Primary Heap

The primary heap will consist of fresh ore from the agglomeration drum that is stacked using grasshopper conveyors and radial stacker and is irrigated (300-IR-01) from the intermediate leaching solution (ILS) pond (300-PD-02). The ILS pond will contain a low concentration leached solution from the secondary pad. The primary heap is leached for 120 days and the pregnant leach solution (PLS) from the primary heap is collected in the pregnant solution pond (300-PD-03). The leached ore then becomes the secondary heap by rerouting the flow of the particular piping.

### 2.4.9 Secondary Heap

The secondary heap will consist of leached ore from the primary heap that is stacked using grasshopper conveyors and radial stacker and is irrigated (300-IR-02) from the

barren solution pond (300-PD-01). The barren pond solution contains leftover metal sulphates from the solvent extraction raffinate. The ILS from the secondary heap is collected in the ILS pond (300-PD-02) after the ore is spent. The spent ore becomes the washing heap by rerouting the flow of particular piping.

#### **2.4.10 Washing Heap**

The washing heap will consist of spent ore from the secondary heap that is stacked using grasshopper conveyors and radial stacker and irrigated with solution from the barren pond (300-PD-01). This ore is washed with solution through drip irrigation (300-IR-03) for 120 days. The solution from the heap is collected in the barren pond (300-PD-01) and used for leaching of the secondary heap.

### **2.5 Crud Removal System**

Several operations have installed pinned-bed filters (400-FL-01/02/03/04/05/06) on the PLS streams and have been effective of crud removal, there are examples where the total suspended solids are consistently reduced to <20 mg/L. This is effective as the uncontrolled separation of solids from the process liquor is usually a significant contributor to crud formation. This technique is highly recommended to be used in conjunction with other processing options.

### **2.6 Crud Treatment**

Crud formation at the interface of the aqueous and organic phases is a common issue for solvent extraction which will lead to loss of organic and lower metal extraction efficiency. Crud treatment has been included in the process to optimise organic recovery and quality. Crud will be collected from each mixer settler and will be transferred to a crud treatment tank where kerosene, clay and diatomaceous earth will be added. The clay and diatomaceous will remove the interfacial-active contaminates. The mixture from the crud treatment tank is then transferred to a scroll centrifuge (400-CF-01) via a peristaltic pump to separate the clay and organic. The recovered organic is recycled back to the organic control tank (400-TK-04) and the spent clay is transferred to a storage drum (400-STD-01) which will be sent to disposal.

## 2.7 Copper Solvent Extraction/Electrowinning

The copper solvent extraction (SX) can be performed with a ketoxime, salicylaldoximes or a mixture of both. Commonly used extractants for copper solvent exchange are LIX 984N, LIX973N, LIX26, LIX84-I, LIX54, LIX 65, LIX-64N and LIX 63. LIX984N is made up of C<sub>9</sub> aldoxime and C<sub>9</sub> ketoxime at a mixing ratio of 1:1 and is known to have good copper extraction efficiency, good Cu/Fe separation performance and lower concentration requirement. LIX984N is therefore selected as the extractant for this project.

The extraction circuit will consist of two extraction cells (400-SX-01/02), and two stripping cells (400-SX-03/04). Two extraction cells are used due to the high concentration of copper in the solution to extract as much copper into the organic phase as possible.

Solvent extraction works by combining an organic extractant with an aqueous acid leaching solution at a favourable pH to transfer metal ions of interest into the organic phase. The copper depleted aqueous phase is referred to as the raffinate is sent to the next circuit. The extraction of copper from dilute sulphuric acid is pH dependent with most copper SX being performed at a pH of 2. Due to the similarities in acid dissociation constants the iron in solution will have to be monitored and subsequently removed to improve the copper grade in the end product.

Synthetic organic chemicals are specifically built to be highly selective for copper over the other metal ions in the PLS. By only extracting copper and then allowing the loaded organic to separate from the aqueous phase (raffinate), the purification stage of solvent extraction has been achieved. The organic is insoluble in the aqueous phase so the phases will always separate due to the differences in density. Since the organic density (0.81 kg/L) is less than the density of the PLS (1.1 kg/L) the organic will always float on top of the aqueous. To assist in separation from the aqueous phase products are diluted with a hydrocarbon based solvent. This is an inert kerosene based hydrocarbon which simply acts as a carrier medium for the extractant. The copper loaded aqueous phase is sent for processing whilst the organic phase is recycled back into the extraction cells to be recycled.

## Extraction

In the extraction stages the PLS solution is mixed with organic solution containing extractant. The extractant releases its protons and coordinates with copper, transferring the copper from an aqueous phase to organic phase as an extractant complex. The protons released increase the acid level.

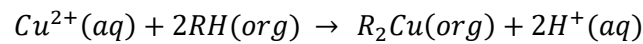

Where,

$Cu^{2+}(aq)$  - is copper in solution

$RH(org)$  - is the extractant i.e stripped organic

$R_2Cu(org)$  - is the copper/extractant i.e. loaded organic

$2H^+(aq)$  - is acid in raffinate solution

## Stripping

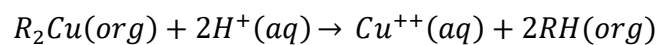

Stripping may be accomplished by contacting the copper containing (loaded) organic with relatively strong sulphuric acid. In most cases, an excess acid concentration of approximately 50 g/L  $H_2SO_4$  is required to maintain adequate stripping. Spent electrolyte (containing copper) may be used as the stripping agent, and the copper content can be increased to any desired level up to about 100 g/L Cu for use as a strong electrolyte. Stripping of copper occurs only when strongly acidic solution is mixed with the organic copper complex. The complex releases its copper and takes on acid.

## Products

The copper sulphate solution will be converted to copper metal via electrowinning. The copper electrolysis process involves electroplating of copper from copper sulphate onto a cathode. This is done by passing a current from an inert anode through the solution which causes the copper to plate out. The spent solution from copper electrowinning is sent to the stripping liquor tank and then to the strip liquor



makeup tank (400-TK-05). The cathodes loaded with metallic copper will then be washed in a cathode washing tank. The washed cathodes are sent to a flexing station and a stripping station to release the metallic copper from the cathodes while the washing water will be directed to the barren pond (300-PD-01). The metallic copper is transferred to a strapping station and a weighing station where it will be palletised and weighed prior to transport.

The copper sulphate solution can alternately be sent to an evaporative crystalliser (400-PK-01) where the water is drawn off to leave behind a saturated copper sulphate solution with blue crystals evolving; copper sulphate crystallises as a pentahydrate ( $\text{CuSO}_4 \cdot 5\text{H}_2\text{O}$ ). This is continuously done and refluxed to obtain a high level of saturation which is sent to a centrifuge to collect the copper sulphate solids product. The solution is recycled back into the stripping cell to recycle, and subsequently retain the uncrystallised copper sulphate. The solid product is sent to a flash dryer (400-FD-01) where water is further drawn off and the product is then collected into the product bin (400-BN-01).

## 2.8 Iron and Aluminium Precipitation

Iron and aluminium in the ore is approximately 9.4% and 2.72% respectively which will build up as the process continues. The iron and aluminium build up in the solution needs to be treated before recycling the SX raffinate for heap leaching. Precipitation is commonly done on acid mine drainage streams to remove iron and aluminium from solution, some studies achieve up to 98% recoveries at low pH values. This is achieved by increasing the pH to 4-5, precipitating iron from solution. The precipitation does not need to precipitate 100% of the iron and aluminium as it is only a bleed to clean up the solution. Therefore the pH can be increased to an acceptable level to let a portion of the iron and aluminium precipitate out.

The process involves pumping the solution from the copper raffinate return line into the iron precipitation tank (500-TK-01) where lime is added to adjust the pH. Iron will be present primarily as iron sulphate ( $\text{FeSO}_4$ ) which when reacted with lime will produce iron hydroxide ( $\text{Fe}(\text{OH})_2$ ). Additionally, aluminium will also be present as a sulphide ( $\text{Al}_2(\text{SO}_4)_3$ ) and will produce an oxide when precipitated. At an elevated pH the hydroxide will precipitate out of solution as a red insoluble oxide. This will be

transferred to the iron tailings thickener (500-TH-01) where the oxide is collected, filtered (500-FL-01/02) and disposed of by dry stacking. The thickener overflow will be sent to raffinate recycle tank (500-TK-03) and then will be pumped into the barren solution pond where it can be recycled to the heap leach pad.

The impurity removal process can be conducted before or after the solvent extraction processes. This is dependent on the concentration of iron and aluminium in the ore, which from preliminary studies is seen to be relatively low, therefore may not have a significant impact on solvent extraction and can be performed after the copper SX. Only partial amounts of the barren solution will be treated to remove iron and aluminium content which the treated solution will be transferred back into the barren pond whilst the solids are disposed of. Conducting on the end raffinate is more feasible as the barren pond will be less selective in the leaching pH. Additionally, the agglomeration drum feeds in ore at the correct pH and will act as a pH regulator.

Dry stacking will be conducted to maximise the amount of water recovered. This will have an impact on capital and operating costs however the apparent advantages include:

- Elimination of catastrophic tailings failures (tailing runoff)
- Easier to close and rehabilitate, thus reducing closure costs
- Progressive rehabilitation possible
- Good in areas of high seismic activity
- No groundwater contamination
- Huge water conservation advantages
- Smaller footprint

Due to the location of this deposit there is a strong case for dry stacking due to the arid climate and increased water loss through precipitation, low rainfall and low groundwater availability. Additionally, due to the deposit lying 11 km from Orange River a tailings dam failure would be catastrophic to Namibia, South Africa and Lesotho as it is the longest river (2,460 km) in Africa and is a lifeline to these three countries.

## 2.9 Metallurgical Accounting

Ongoing metallurgical accounting will be carried out to provide diagnostic information to the management for making effective decisions to control mining and metallurgical operations. The SCADA system will be used for the met accounting. The metallurgical accounting programme will involve the following:

- Control/ monitor flows using flowmeters of all key solutions, including make-up of leachant, other reagents and water
- Sample solutions and assay
- Determine bacterial activity for sulphides
- Column leaches – data for projection of heap performance for new ore
- Compare real data to modelled data for each panel
- Monitor/control leachant usage – generally high cost item
- Sample barren heaps before over stacking
- Update models with analyses if possible
- Determine metal balances
- Ore heaps in cells with laboratory tests on samples before and after leaching
- Prepare production statement for LME cathodes

### 2.9.1 Data Collection

The accuracy and reliability of the metallurgical accounting programme is relying on the accuracy of process data collected. The data collection for the process will include the following:

- Sampling solutions from individual panels
- Solution analysis – metals, contaminants, leachant strength, solids, pH
- Use of lysimeter or other means for sampling various points in heaps
- Monitor grade and mineralogy of ore feed from mine
- Size distribution analysis of crushed ore

- Moisture content of crushed ore and agglomerates
- Metal content, key impurities of crushed ore

## **2.10 Water Distribution**

### **2.10.1 Raw Water**

The raw water dam (600-DM-01/02) sends water to processes that require higher quality of water than process water. Raw water is used for dust suppression, potable water supply, fire water, gland seal water, cathode washing and reagents makeup water. This water is also used in the agglomeration drum (300-AD-01), barren pond (300-PD-01), copper electrowinning (400-EC-01), iron tailings filter press (500-FL-01/02), process solution heating and cooling.

### **2.10.2 Spillages and Storm Water**

In order to preserve as much water as possible, bunding is installed around all of the major sections of the plant, sumps are located inside these areas and serve to pump any spillages back into the plant. Storm water runoff drains are able to handle a one in 100 years, 24 hour rainfall event.

## **2.11 REAGENTS AND CONSUMABLES**

Reagents are mixed in an open area in covered tanks to prevent rain from damaging or reacting with the dry chemicals. The design incorporates accepted methods for mixing, holding, solution distribution and ventilation for each chemical according to MSDS and industry practice. Reagents are kept in a warehouse until they are required. Containment bunds and sump pumps are required for individual reagent handling areas. The sump pumps feed any spilled reagents into the respectively tank depending on reagent area. An overhead crane (700-MT-01) handles the reagents and services the reagent mixing tanks.

### **2.11.1 Quicklime**

Quicklime is delivered by tanker and stored in a feed silo (700-BN-01). The quicklime is fed into a lime slaking mill (700-PK-01) by a quicklime screw feeder (700-FE-01). The lime slurry is then moved to a distribution tank (700-TK-01) through two lime

transfer pumps (duty/standby) (700-PP-01/02) before being fed via six metering pumps (duty/standby) (700-PP-03/04, 700-PP-05/06 and 700-PP-07/08), to the pH adjustment tanks (300-TK-01 and 400-TK-01) and the iron precipitation tank (500-TK-01).

### **2.11.2 Limestone/Calcrete**

Limestone/calcrete is delivered by tanker and stored in a feed silo (700-BN-02). The limestone/calcrete is fed into a distribution tank (700-TK-02) where it is made into slurry by mixing with water. The slurry is then transferred via six metering pumps (duty/standby) (700-PP-09/10, 700-PP-11/12 and 700-PP-13/14); to the pH adjustment tanks (300-TK-01 and 400-TK-01) and the iron precipitation tank (500-TK-01).

### **2.11.3 Clay**

Clay will be delivered to site and stored in a clay pallet and will be used to remove impurities entrained in the organic.

### **2.11.4 Diatomaceous Earth**

Diatomaceous earth will be delivered to site and stored in a clay pallet and will be used for crud treatment.

### **2.11.5 Sulphuric Acid**

Sulphuric acid is delivered by tanker and will be stored in an acid storage tank (700-TK-03). Sulphuric acid is transferred via acid metering pumps (700-PP-15/16, 700-PP-17/18, 700-PP-19/20, and 700-PP-21/22) and is used for agglomeration drums, pH adjustment, stripping liquor makeup and scrubbing liquor makeup.

### **2.11.6 LIX984N**

LIX 984N is used as the extractant in the organic phase. It is delivered to site in 1000 L isotainers and is kept in the isotainers until needed to make up fresh extractant. Fresh organic phase is made up in a mixing tank (700-TK-04) by mixing diluent (kerosene) at 85%wt with LIX 984N 15%wt. LIX 984N is kept in a rubber lined tank until it is dispensed via metering pump (duty/standby) (700-PP-25/26) as required.

### **2.11.7 Guar Gum**

Guar gum is used as the smoothing agent in the electrowinning process to allow the cathodes to collect metal more uniformly. It is delivered to site in bulk bags and will be prepared in a guar gum vendor package (700-PK-02). The bulk bags will be broken over a bag breaker on top of the guar gum feed hopper. Guar gum powder is fed to the guar gum mixing tank by a screw feeder. A blower is used to blow guar gum powder into the special gentle wetting head where guar gum is mixed with process water, prior to being fed to the mixing tank.

A homogeneous guar gum solution from the mixing tank will be transferred to the electrowinning cells by the guar gum metering pumps (duty/standby).

### **2.11.8 Cobalt Sulphate**

Cobalt sulphate is used in the electrowinning process to reduce the rate of corrosion of anodes as well as to reduce the contamination of copper cathodes. It is delivered to site in the form of 25 kg bags of powder and will be prepared in a cobalt sulphate vendor package (700-PK-03). The bags will be broken over a bag breaker on top of the cobalt sulphate mixing tank where it will be mixed with process water to prepare a homogeneous cobalt sulphate solution. The solution will be transferred to the electrowinning cells by the cobalt sulphate metering pumps (duty/standby).

### **2.11.9 Kerosene**

Kerosene is used as the bulk of the organic extracting phase and the crud treatment reagent. It is delivered by trucks and kept in the kerosene distribution tank (700-TK-05) until needed to make up fresh organic phase. Kerosene is stored in a steel tank until it is pumped via metering pumps (duty/standby) (700-PP-27/28 and 700-PP-29/30) to the crud treatment tank and the organic (LIX) mixing tank.

### **2.11.10 Polyacrylamide**

Polyacrylamide is used as the binder in the agglomeration circuit. It is delivered to site in approved 1 ton bulk bags. Polyacrylamide is fed to the agglomeration drums in solution form which will be prepared in a polyacrylamide vendor package (700-PK-04). The bulk bags will be broken over a bag breaker on top of the polyacrylamide feed hopper. Polyacrylamide powder is fed to the polyacrylamide mixing tank by a

screw feeder. A blower is used to blow polyacrylamide powder into the special gentle wetting head where polyacrylamide is mixed with process water to 0.025%, prior to being fed to the mixing tank.

A homogeneous polyacrylamide solution from the mixing tank is pumped via polyacrylamide transfer pumps into the polyacrylamide distribution tank. From here, the polyacrylamide is distributed to the agglomeration drums by polyacrylamide metering pumps (duty/standby).

#### **2.11.11 Flocculant**

Flocculant, in the form of 25 kg bags of powder, is delivered and stored in the flocculant area. Flocculant solution is prepared in a flocculant vendor package (700-PK-05) as following. Flocculant bags are broken over a bag breaker on top of the flocculant feed hopper. Flocculant is fed to the flocculant mixing tank by a flocculant screw feeder. A blower is used to blow flocculant powder into the special gentle wetting head where flocculant is mixed with process water to 0.025%, prior to being fed to the mixing tank.

A homogeneous flocculant solution from the mixing tank is pumped via flocculant transfer pumps (duty/standby) into the flocculant distribution tank. From here, the flocculant is distributed to the pH adjustment thickeners (300-TH-01 and 400-TH-01) and the iron tailings thickener (500-TH-01) by flocculant metering pumps (duty/standby).

### **2.12 SERVICES**

#### **2.12.1 Air**

Compressed air for the existing operation is supplied to the industrial process area via two compressors (800-CP-01/02) that feed into air receiver (800-RA-01) with a pressure of 750 kPa. From the air receiver process air is passed through an air filter system (800-FL-01) and is sent to copper processing, iron removal and reagents areas.

Instrument air has a required dew point of  $-40^{\circ}\text{C}$  and low oil and dust content. Instrument air is passed through a dryer (800-DR-01) to eliminate any contaminants. From the dryer, it is fed to a 750 kPa instrument air receiver (800-RA-02). Before

being distributed to the rest of the plant, the air is passed through the instrument air filter (800-FL-02).

### **2.12.2 Potable Water**

Potable water is produced by further treatment of the raw water supply in a separate water treatment plant package. The potable water treatment process includes active carbon filters to remove odours and a chlorination system. This water will be used for human consumption, as well as to supply quality water to the plant for eye wash stations and safety showers.

### **2.12.3 Diesel**

Diesel is held in the diesel storage tank (800-TK-05). The diesel will be transferred to process plant via diesel distribution pump (duty/standby) (800-PP-13/14). The diesel storage tank also feeds the light vehicle meter bowser via light vehicle pump (800-PP-11) and the mobile equipment plant fast fill bowser via mobile equipment pump (800-PP-12).

### **2.12.4 Cooling Water**

Cooling water will be used to cool down the aqueous solution for the solvent extraction process. Process water will be used as the cooling water and will be recycled to a cooling water recycling tank (800-TK-06) for storage until needed. Water from the recycling tank will be pumped to a cooling tower (800-CZ-01) to cool down the water to the required temperature and will be transferred to a cooling water storage tank by cooling water pumps (duty/standby) (800-PP-15/16). From here, the cooling water will be directed to the solvent extraction process via cooling water distribution pumps (duty/standby) (800-PP-17/18).

### **2.12.5 Heating Water**

Heating water will be used to heat up the aqueous solution for the solvent extraction process. Process water will be used as the heating water and will be recycled to a heating water recycling tank (800-TK-06) for storage until needed. Water from the recycling tank will be pumped to a pipe heat exchanger (800-HX-01) to heat up the water to the required temperature and will be transferred to the solvent extraction process.





Table 1	
1	1
2	2
3	3
4	4
5	5
6	6
7	7
8	8
9	9
10	10

Table 2	
1	1
2	2
3	3
4	4
5	5
6	6
7	7
8	8
9	9
10	10

Figure 1

© 2010 The Author(s). All rights reserved. This article is published with open access at [www.sciencedirect.com](http://www.sciencedirect.com)

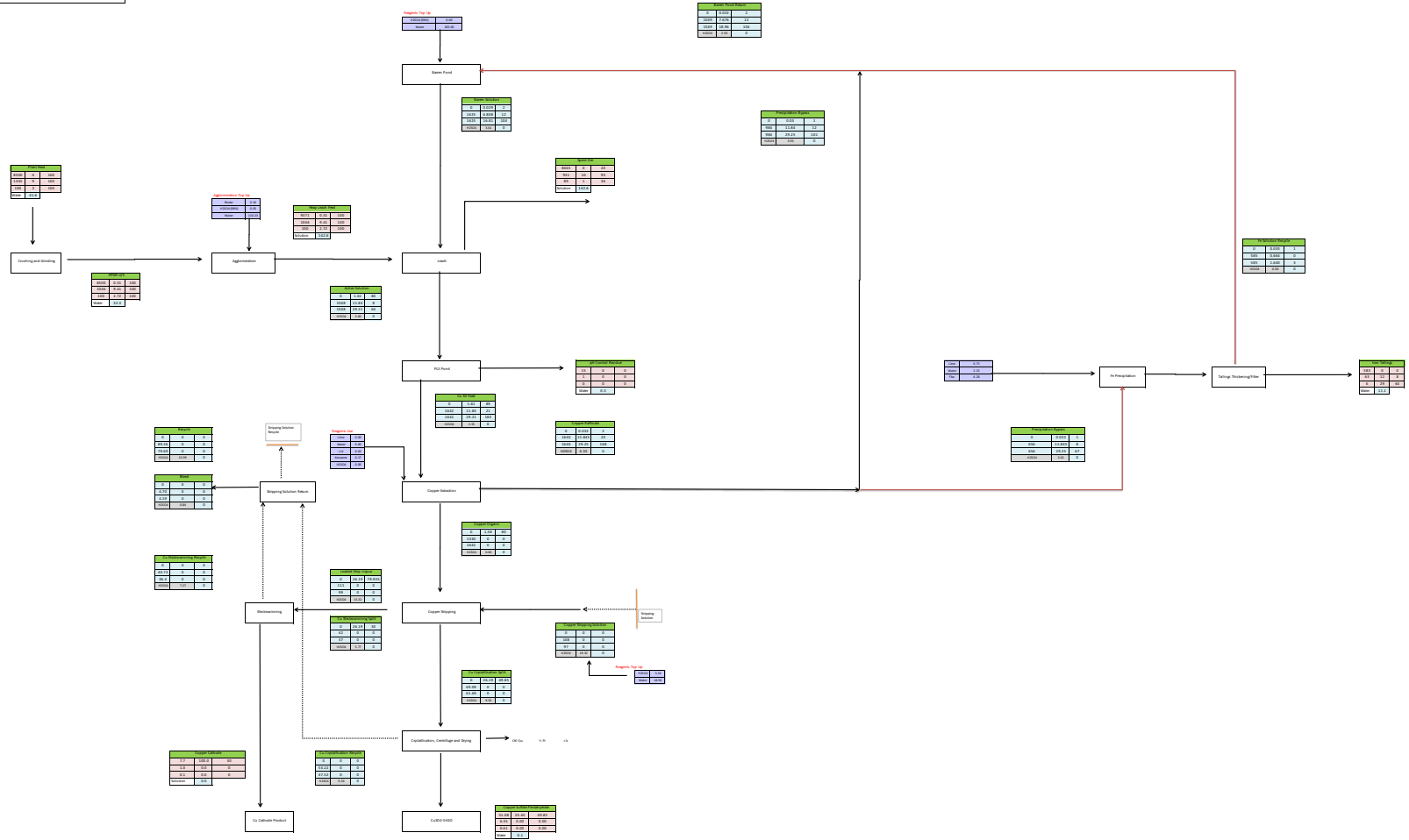

Year	2017	2018	2019
Revenue	100	110	120
Cost of Sales	60	65	70
Operating Profit	40	45	50

Option 2

Year	2017	2018	2019
Revenue	100	110	120
Cost of Sales	60	65	70
Operating Profit	40	45	50

NOTE: All calculations are rounded to 2 decimal places.

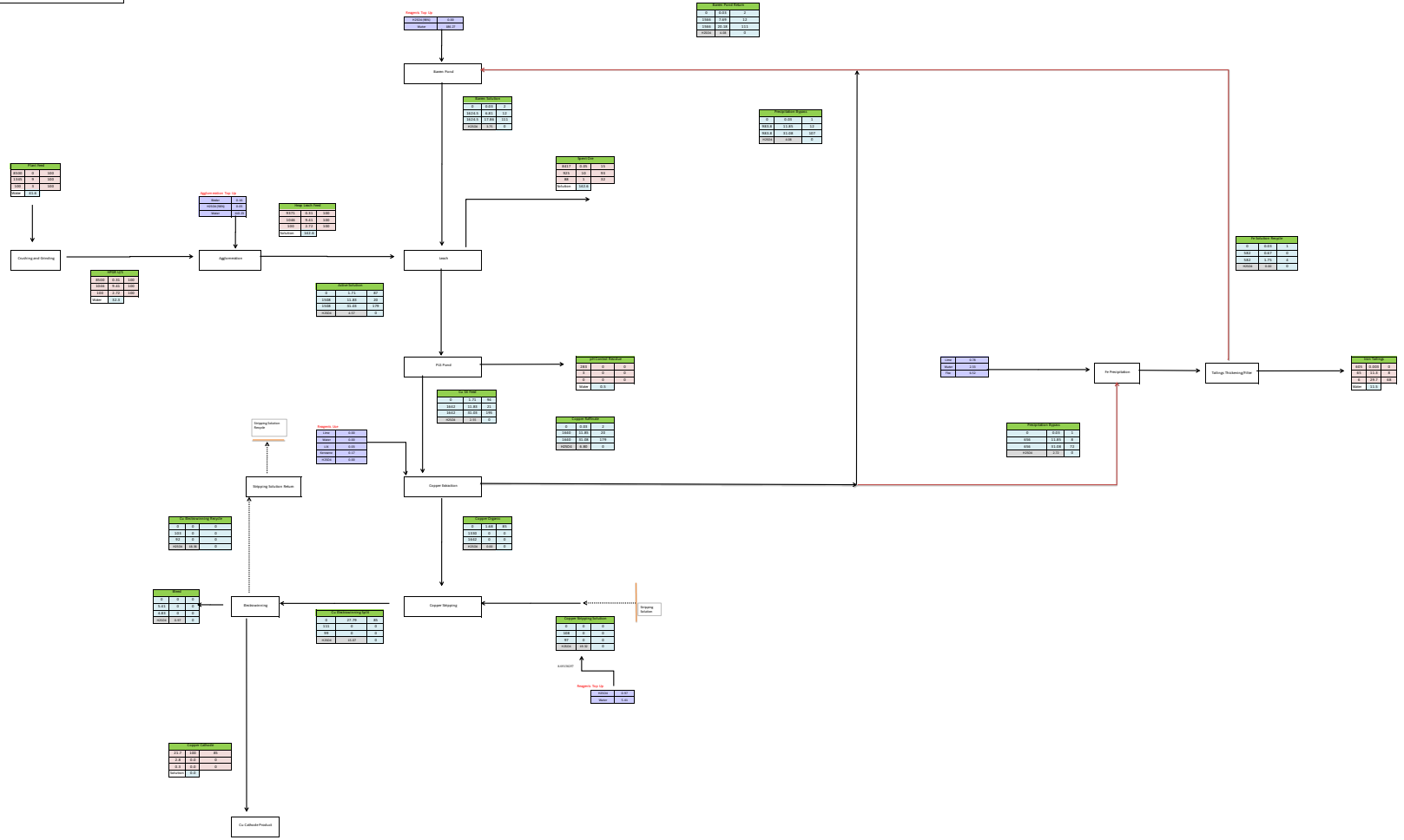

Kunden	
1000	1000
1001	1001
1002	1002
1003	1003
1004	1004
1005	1005
1006	1006
1007	1007
1008	1008
1009	1009
1010	1010

Produkte	
1001	1001
1002	1002
1003	1003
1004	1004
1005	1005
1006	1006
1007	1007
1008	1008
1009	1009
1010	1010

Option 3

© 2010 SAP AG. Alle Rechte vorbehalten. SAP und SAP Logo sind Marken der SAP AG.

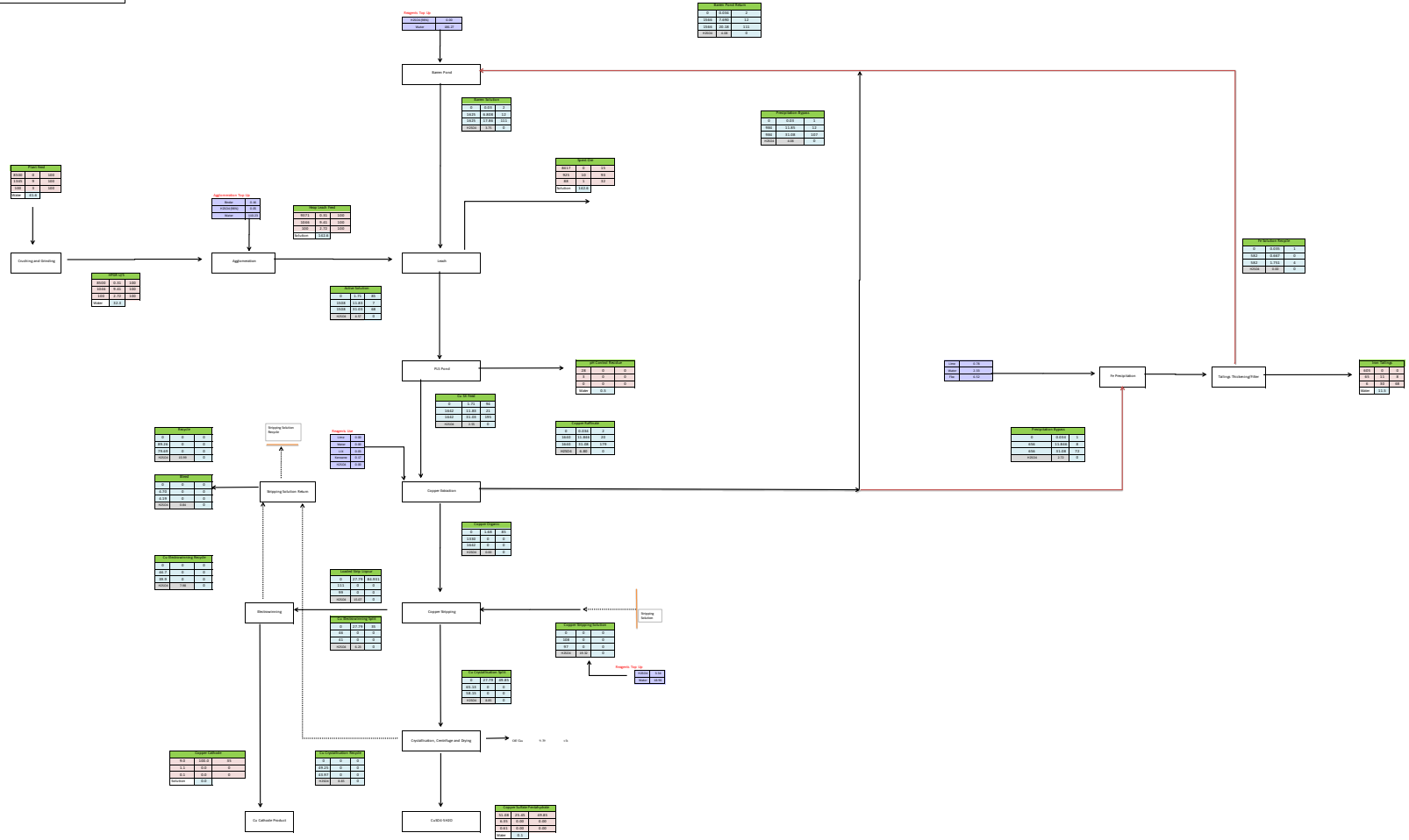

Option 1	
Option 1	Option 2
Option 1	Option 2
Option 1	Option 2
Option 1	Option 2

Option 2	
Option 2	Option 1
Option 2	Option 1
Option 2	Option 1
Option 2	Option 1

Option 1

© 2010 The McGraw-Hill Companies, Inc.

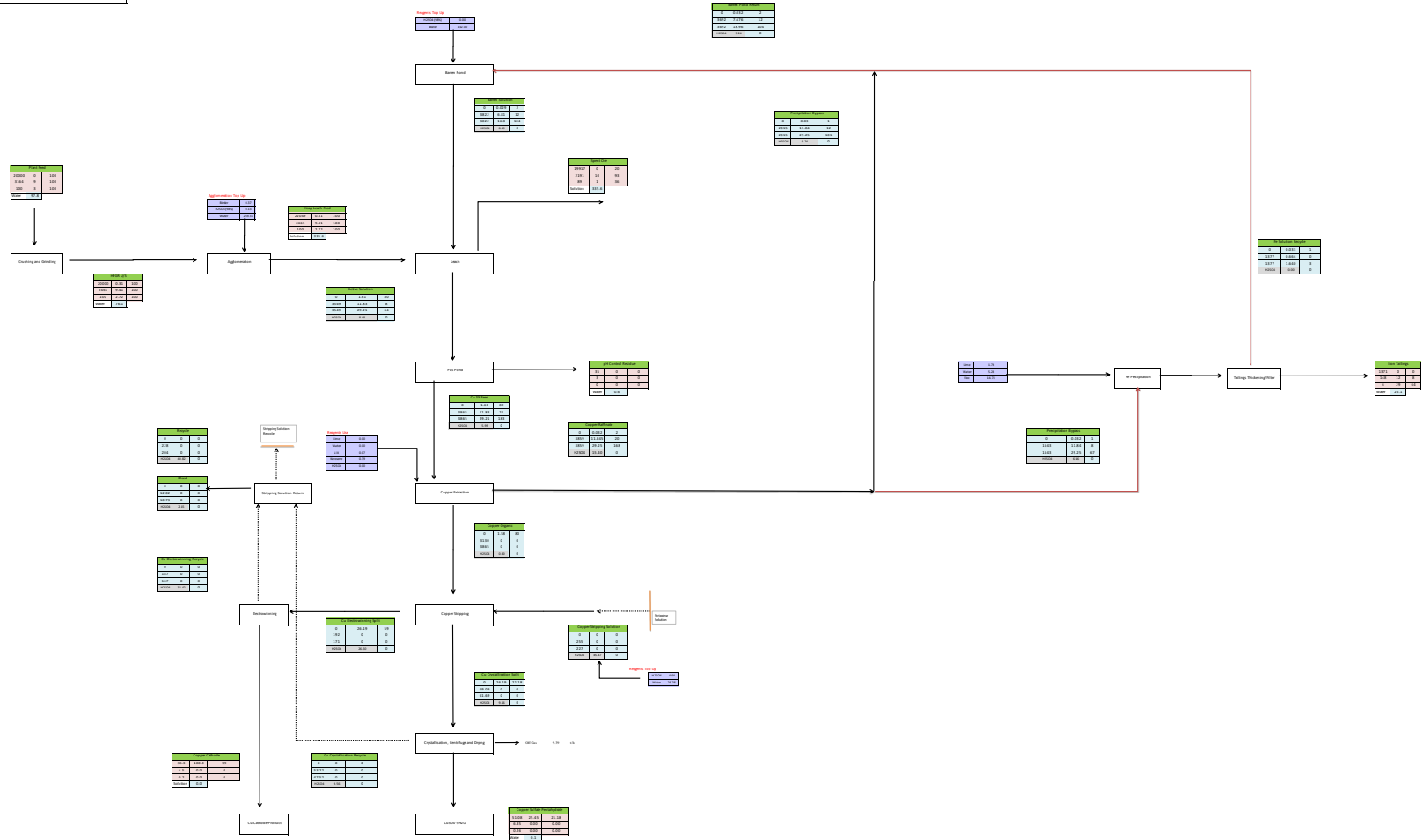

Option 1		
100%	100%	100%
100%	100%	100%
100%	100%	100%
100%	100%	100%
100%	100%	100%
100%	100%	100%
100%	100%	100%
100%	100%	100%
100%	100%	100%
100%	100%	100%

Option 1

Costs are measured in thousands of Euro (k€)

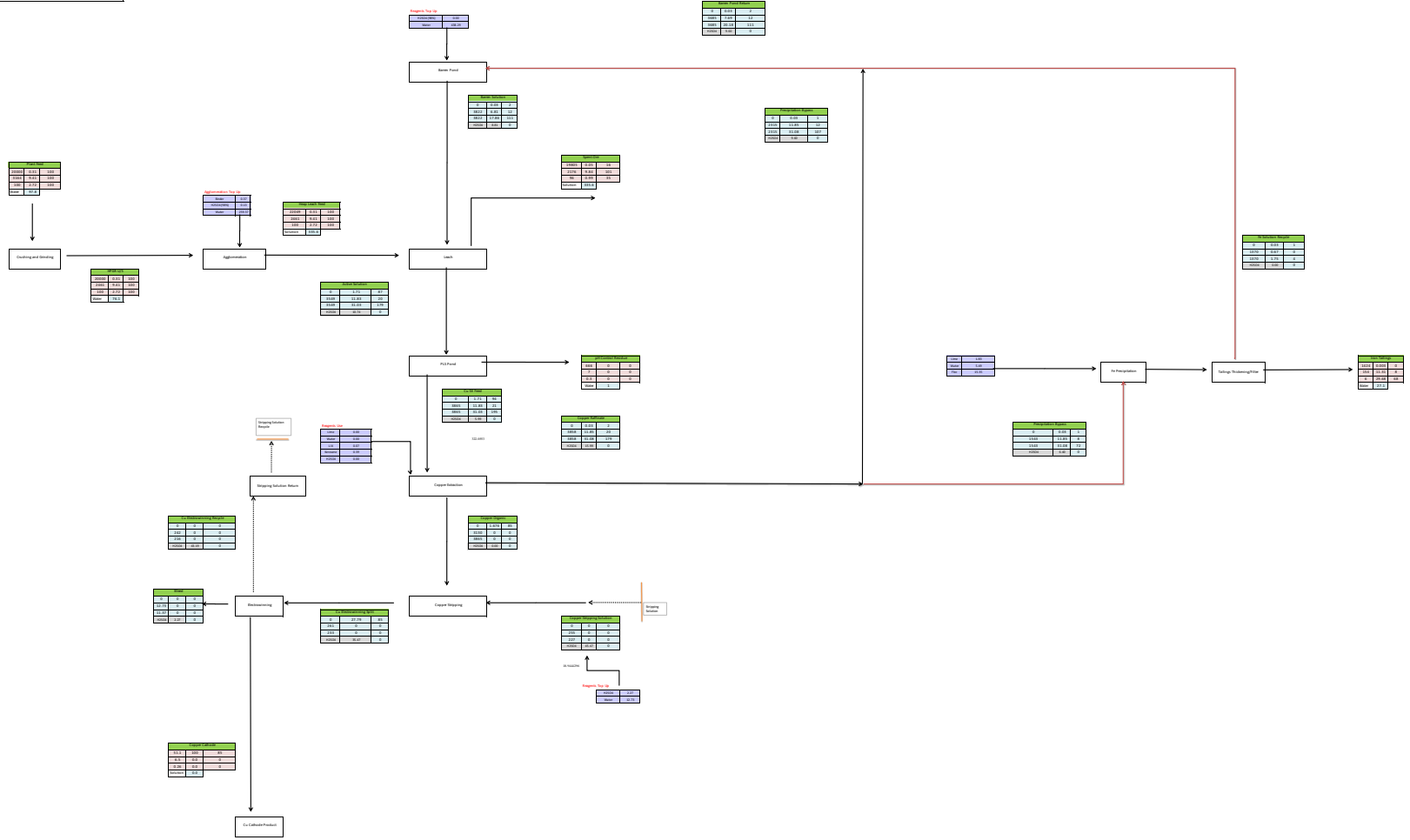

Option 1	
Option 1	Option 2
Option 1	Option 2
Option 1	Option 2
Option 1	Option 2

Option 2	
Option 2	Option 1
Option 2	Option 1
Option 2	Option 1
Option 2	Option 1

Option 1

© 2010 The McGraw-Hill Companies, Inc.



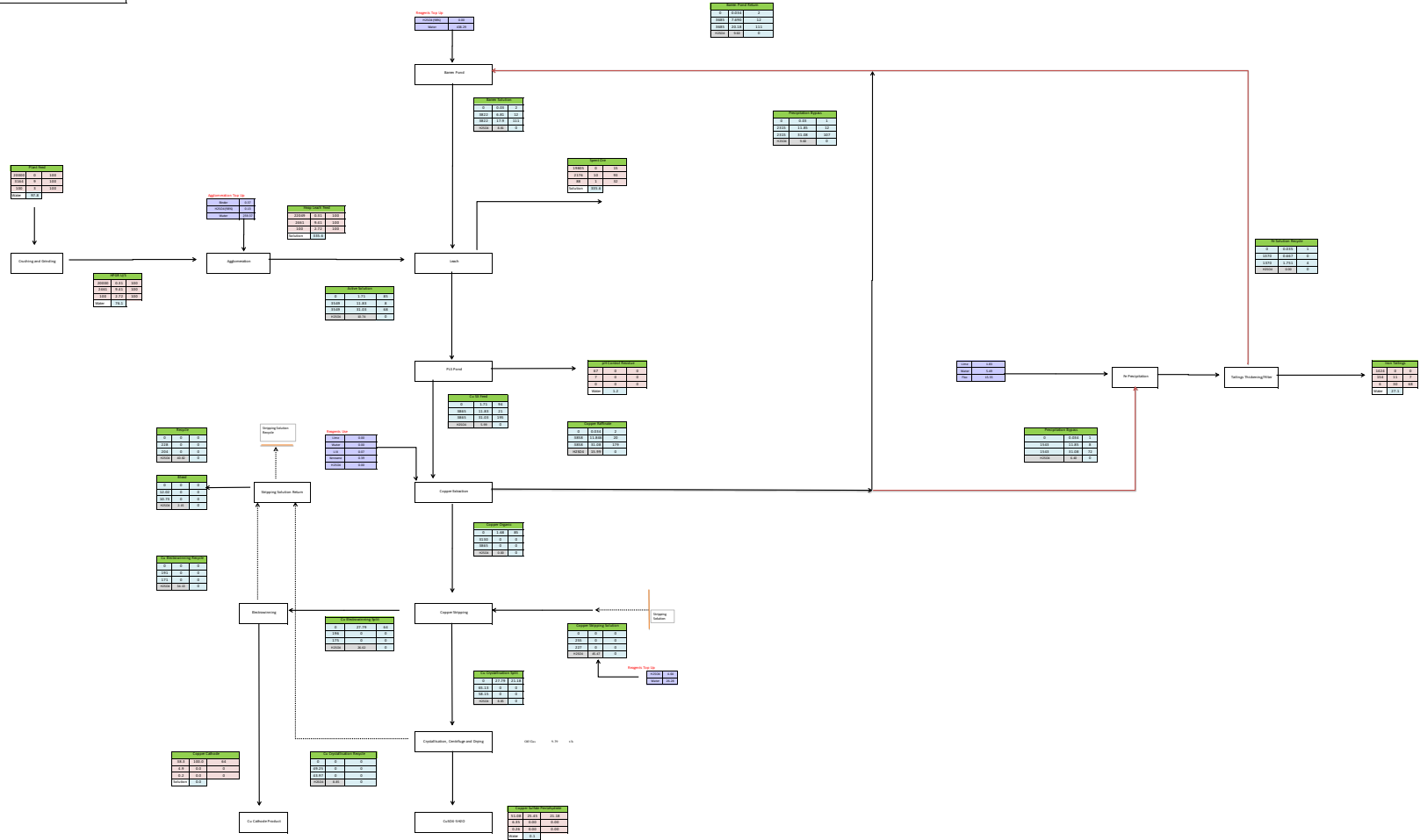



Client  
Deep South Resources

Project  
Hab Leach Project - 8.5 Mtpa @ 80% Cu Recovery/CuSO4

Document Number  
J5459-CAL-000-001

Quantity	Equipment Number	Area Number	Equipment	Tag	Description	Model/Type (Equivalent or similar)	Equipment Price (USD)	Estimated Power (kW)	Scaled Cost (USD)	Supplier	Scaled Capacity	Units	Scaled Power (kW)	Diversity	Diversified Power (kW)	Basis Capacity	Units	Basis Power (kW)	Basis Cost (USD)	Reference	
1	100-BN-01	100	BN	01	ROM Bin		\$ 118,000		\$ 117,880	Local Fabrication	149	m <sup>2</sup>				236	m <sup>2</sup>		\$ 151,623	2	
2	100-BN-02-03	100	BN	02-03	Cone Crusher Feed Bin		\$ 420,000		\$ 209,628	Local Fabrication	388	m <sup>2</sup>				74	m <sup>2</sup>		\$ 77,596	2	
1	100-CR-01	100	CR	01	Gyratory Crusher	CG510i	\$ 2,065,000	315	\$ 2,064,560	Sandvik	1386	th	315	0.66	208					6	
2	100-CR-02-03	100	CR	02-03	Cone Crusher	CH870i-03	\$ 2,095,000	1200	\$ 1,046,139	Sandvik	1396	th	600	0.84	1013					6	
1	100-CV-01	100	CV	01	Primary Crusher Discharge Conveyor	1200mm x 150 m x 25 m	\$ 330,000	250	\$ 330,000	Sarwest	2792	th	250	0.85	213	1	m		\$ 2,200	2	
2	100-CV-02-03	100	CV	02-03	Cone Crusher Feed Conveyor	1200 mm x 15 m	\$ 54,000	22	\$ 27,000	Sarwest	1396	th	11	0.85	19	1	m		\$ 1,800	2	
1	100-CV-04	100	CV	04	Cone Crusher Discharge Conveyor	1200mm x 100 m x 25 m	\$ 220,000	250	\$ 220,000	Sarwest	2792	th	250	0.85	213	1	m		\$ 2,200	2	
1	100-CV-05	100	CV	05	Screen US Discharge Conveyor	1200mm x 75 m x 10 m	\$ 165,000	160	\$ 165,000	Sarwest	1663	th	160	0.85	136	1	m		\$ 2,200	2	
2	100-CV-06-07	100	CV	06-07	Crushed Ore Discharge Conveyor	1200 mm x 20 m	\$ 72,000	22	\$ 36,000	Sarwest	832	th	11	0.85	19	1	m		\$ 1,800	2	
1	100-CV-08	100	CV	08	Crushed Product Conveyor	1200 mm x 4500 m x 30 m	\$ 7,650,000	1650	\$ 7,650,000	Sarwest	1663	th	1650	0.85	1403						2
1	100-FE-01	100	FE	01	Primary Crusher Discharge Apron Feeder	Apron Feeder - 1219mm x 6000mm	\$ 319,000	164	\$ 318,319	Sarwest	1663	th	164	0.85	140	450	th	75	\$ 145,275	2	
2	100-FE-02-03	100	FE	02-03	Cone Crusher Vibrating Feeder		\$ 213,000	85	\$ 106,495	Sarwest	1396	th	43	0.75	64	780	th	30	\$ 75,040	2	
2	100-FE-04-05	100	FE	04-05	Cone Crusher Stockpile Discharge Apron Feeder	Apron Feeder - 1219mm x 6000mm	\$ 421,000	217	\$ 210,012	Sarwest	832	th	108	0.85	184	450	th	75	\$ 145,275	2	
3	100-MD-01-03	100	MD	01-03	Metal Detector		\$ 69,000	0	\$ 23,000											4	
1	100-MG-01	100	MG	01	Tramp Metal Magnet		\$ 50,000	0	\$ 50,000											4	
1	100-RB-01	100	RB	01	Mobile Rock Breaker		\$ 88,000	0	\$ 87,150											4	
1	100-SC-01	100	SC	01	Crusher Product Screen	Metso T86.2 Double-Deck Banana	\$ 590,000	66	\$ 589,825	Metso	25	m <sup>2</sup>	66	0.85	56	26	m <sup>2</sup>		\$ 600,000	2	
1	100-SH-01	100	SH	01	Primary Crusher Area Safety Shower and Eyewash Station		\$ 4,000	0	\$ 4,000											4	
1	100-SH-02	100	SH	02	Screening Area Safety Shower and Eyewash Station		\$ 4,000	0	\$ 4,000											4	
1	100-SH-03	100	SH	03	Cone Crusher Safety Shower and Eyewash Station		\$ 4,000	0	\$ 4,000											4	
1	100-SV-01	100	SV	01	Surge Vault		\$ 158,000	0	\$ 157,542	Local Fabrication	257	m <sup>3</sup>				300	m <sup>3</sup>		\$ 173,000	2	
1	100-WS-01-04	100	WS	01-04	Water Sprayer		\$ 50,000	0	\$ 50,000											4	
7	100-WT-01-07	100	WT	01-07	Weightometer		\$ 228,000	0	\$ 32,500											4	
1	100-SHD-01	100	SHD	01	Crusher Control Room		\$ 25,000	0	\$ 24,283											4	
1	100-YFL-01	100	YFL	01	Front End Loader		\$ 520,000	0	\$ 520,000											4	
1	100-SP-01	100	SP	01	Crushed Product Stockpile		\$ 1,000,000	0	\$ 1,000,000		19961	t								2	
1	200-SP-01	200	SP	01	HPGR Feed Stockpile		\$ 1,600,000	0	\$ 1,600,000		62100	t								2	
2	200-BN-01-02	200	BN	01-02	HPGR Feed Bin		\$ 161,000		\$ 80,099	Local Fabrication	78	m <sup>2</sup>				74	m <sup>2</sup>		\$ 77,596	2	
2	200-BN-03-04	200	BN	03-04	Screen Feed Bin		\$ 161,000		\$ 80,099	Local Fabrication	78	m <sup>2</sup>				74	m <sup>2</sup>		\$ 77,596	2	
2	200-CV-01-02	200	CV	01-02	Stockpile Discharge Conveyor	1200 mm x 20 m	\$ 72,000	22	\$ 36,000	Sarwest	647	th	11	0.85	19	1	m		\$ 1,800	2	
1	200-CV-03	200	CV	03	HPGR Feed Conveyor	1200mm x 150 m x 25 m	\$ 330,000	160	\$ 330,000	Sarwest	1662	th	160	0.85	136	1	m		\$ 2,200	2	
2	200-CV-04-05	200	CV	04-05	HPGR Feeders	1200 mm x 15 m	\$ 54,000	22	\$ 27,000	Sarwest	841	th	11	0.85	19	1	m		\$ 1,800	2	
1	200-CV-06	200	CV	06	Screen Feed Conveyor	1200mm x 100 m x 25 m	\$ 180,000	160	\$ 180,000	Sarwest	1662	th	160	0.85	136	1	m		\$ 1,800	2	
1	200-CV-07	200	CV	07	Screen Discharge Conveyor	1200 mm x 75 m x 10 m	\$ 150,000	74	\$ 150,000	Sarwest	1294	th	74	0.85	63	1	m		\$ 2,000	2	
2	200-FE-01-02	200	FE	01-02	HPGR Stockpile Apron Feeder		\$ 362,000	187	\$ 180,617	Sarwest	647	th	93	0.85	159	450	th	75	\$ 145,275	2	
2	200-FE-03-04	200	FE	03-04	HPGR Vibrating Feeder		\$ 156,000	63	\$ 78,525	Sarwest	841	th	31	0.85	53	780	th	30	\$ 75,040	2	
2	200-FE-05-06	200	FE	05-06	Screen Vibrating Feeder		\$ 156,000	63	\$ 78,525	Sarwest	841	th	31	0.85	53	780	th	30	\$ 75,040	2	
2	200-CR-01-02	200	CR	01-02	HPGR	HPGR 63017.6-OWH-1230-PG1E	\$ 7,626,000	5200	\$ 3,812,714	Koepfer	841	th	2600	0.75	3925					2	
2	200-MD-01-02	200	MD	01-02	Metal Detector		\$ 46,000	0	\$ 23,000											4	
2	200-SC-01	200	SC	01	HPGR Screens	Metso T86.2 Double-Deck Banana	\$ 1,180,000	132	\$ 589,825	Metso	25	m <sup>2</sup>	66	0.75	99	26	m <sup>2</sup>		\$ 600,000	2	
1	200-SH-01	200	SH	01	Grinding Area Safety Shower and Eyewash Station		\$ 4,000	0	\$ 4,000											4	
1	200-SH-02	200	SH	02	Screen Area Safety Shower and Eyewash Station		\$ 4,000	0	\$ 4,000											4	
1	200-WS-01-03	200	WS	01-03	Water Sprays		\$ 50,000	0	\$ 50,000											4	
6	200-WT-01-06	200	WT	01-06	Weightometer		\$ 195,000	0	\$ 32,500											4	
1	200-YFL-01	200	YFL	01	Front End Loader		\$ 500,000	0	\$ 500,000											6	
2	300-AD-01-02	300	AD	01-02	Agglomeration Drum	3610	\$ 2,700,000	480	\$ 1,350,000	Sepro Systems	170	m <sup>3</sup>	240	0.75	360					2	
1	300-BN-01	300	BN	01	Agglomerator Feed Bin		\$ 119,000		\$ 118,442	Local Fabrication	150	m <sup>2</sup>				74	m <sup>2</sup>		\$ 77,596	2	
1	300-CH-01	300	CH	01	Filter Press Discharge Chute	Constructed On Site	\$ 5,000	0	\$ 4,500	Local Fabrication										4	
1	300-CV-01	300	CV	01	Agglomerator Feed Conveyor	1200 mm x 75 m x 25 m	\$ 165,000	160	\$ 165,000	Krupp	1294	th	80	0.85	68	1	m		\$ 2,200	2	
1	300-CV-02	300	CV	02	Agglomerator Product Conveyor	1200 mm x 150 m x 40 m	\$ 330,000	160	\$ 330,000	Krupp	1426	th	160	0.85	136	1	m		\$ 2,200	2	
10	300-CV-03	300	CV	03	Grashopper Conveyors	1200 mm x 50 m x 2.5 m	\$ 100,000	200	\$ 100,000	Sarwest	1426	th	20	0.85	170	1	m		\$ 2,000	2	
1	300-CV-04	300	CV	04	Radial Stacker for Primary Leach Heap	Rail Mounted Radial Stacker, 1200 mm x 50 m x 15 m	\$ 531,000	84	\$ 530,705	Krupp	1426	th	84	0.85	71	1750	th		\$ 600,000	2	
1	300-CV-04	300	CV	04	Neutralised Tailings Transfer Conveyor	600 mm x 20 m x 5 m	\$ 36,000	21	\$ 36,000	Sarwest	4	th	21	0.85	18	1	m		\$ 1,800	2	
1	300-FE-01	300	FE	01	Belt Feeder	Belt Feeder	\$ 233,000	23	\$ 232,374	Metso	1294	th	23	0.85	20	320	th	10	\$ 100,500	2	
1	300-IR-01	300	IR	01	Primary Heap Leach Drip Irrigation		\$ 117,000	0	\$ 117,000		120000	m				1	m <sup>3</sup>		\$ 1	2	
1	300-IR-02	300	IR	02	Secondary Heap Leach Drip Irrigation		\$ 117,000	0	\$ 117,000		120000	m				1	th		\$ 1	2	
1	300-IR-03	300	IR	03	Wash Heap Leach Drip Irrigation		\$ 117,000	0	\$ 117,000		120000	m				1	th		\$ 1	2	
1	300-PD-01	300	PD	01	Barren Pond		\$ 1,217,000	0	\$ 1,216,800		46800	m <sup>3</sup>				1	m <sup>3</sup>		\$ 26	3	
1	300-PD-02	300	PD	02	LS Pond		\$ 1,217,000	0	\$ 1,216,800		46800	m <sup>3</sup>				1	m <sup>3</sup>		\$ 26	3	
1	300-PD-03	300	PD	03	Active Solution Pond		\$ 1,217,000	0	\$ 1,216,800		46800	m <sup>3</sup>				1	m <sup>3</sup>		\$ 26	3	
1	300-PP-01	300	PP	01	pH Adjustment Thickeners Feed Pump (Duty)	SDB 200/250/Centrifugal	\$ 58,000	161	\$ 57,667		1949	m <sup>3</sup> /h	161	0.75	121	1400	m <sup>3</sup> /h	132	\$ 47,279	2	
1	300-PP-02	300	PP	02	pH Adjustment Thickeners Feed Pump (Standby)	SDB 200/250/Centrifugal	\$ 58,000	161	\$ 57,667		1949	m <sup>3</sup> /h	161	0.00	0	1400	m <sup>3</sup> /h	132	\$ 47,279	2	
1	300-PP-03	300	PP	03	pH Adjustment Filter Press Feed Pump (Duty)	SDB 200/250/Centrifugal	\$ 58,000	161	\$ 57,667		1949	m <sup>3</sup> /h	161	0.75	12						

Quantity	Equipment Number	Area Number	Equipment	Tag	Description	Model/Type (equivalent or similar)	Equipment Price (USD)	Estimated Power (kW)	Scaled Cost USD	Supplier	Scaled Capacity	Units	Scaled Power (kW)	Diversity	Diversified Power (kW)	Basis Capacity	Units	Basis Power (kW)	Basis Cost (USD)	Reference	
1	300-AG-01	300	AG	01	pH Adjustment Tank Agitator	5 m dia x 10 m	\$ 34,000	19	\$ 33,324	Lighthin	164	m <sup>3</sup>	19	0.85	16	354	m <sup>3</sup>	30	\$ 52,799	2	
1	300-TH-01	300	TH	01	pH Adjustment Thickener		\$ 232,000	0	\$ 231,611	Waterex	6	m				20	m		\$ 499,800	2	
1	300-FL-01	300	FL	01	pH Adjustment Filter Press		\$ 43,000	10	\$ 42,413		3	lhr	10	0.85	8	50	lhr	50	\$ 214,286	2	
1	400-AG-01	400	AG	01	pH Adjustment Tank Agitator	5 m dia x 10 m	\$ 34,000	19	\$ 33,324	Lighthin	164	m <sup>3</sup>	19	0.85	16	354	m <sup>3</sup>	30	\$ 52,799	2	
1	400-AG-02	400	AG	02	Organic Control Tank Agitator	5 m dia x 10 m	\$ 34,000	19	\$ 33,324	Lighthin	164	m <sup>3</sup>	19	0.85	16	354	m <sup>3</sup>	30	\$ 52,799	2	
1	400-AG-03	400	AG	03	Copper Extraction Mixer Settler Agitator	4.2 m dia x 8.4 m	\$ 25,000	14	\$ 24,489	Lighthin	98	m <sup>3</sup>	14	0.85	12	354	m <sup>3</sup>	30	\$ 52,799	2	
1	400-AG-04	400	AG	04	Copper Extraction Mixer Settler Agitator	4.2 m dia x 8.4 m	\$ 25,000	14	\$ 24,489	Lighthin	98	m <sup>3</sup>	14	0.85	12	354	m <sup>3</sup>	30	\$ 52,799	2	
1	400-AG-05	400	AG	05	Stripping Liquor Tank Agitator	2m dia x 4 m	\$ 3,000	1	\$ 2,470	Lighthin	11	m <sup>3</sup>	1	0.85	1	33	m <sup>3</sup>	2.2	\$ 4,829	2	
1	400-AG-06	400	AG	06	Scrubbing Solution Tank Agitator	5 m dia x 10 m	\$ 34,000	19	\$ 33,324	Lighthin	164	m <sup>3</sup>	19	0.85	16	354	m <sup>3</sup>	30	\$ 52,799	2	
1	400-AG-07	400	AG	07	Copper Stripping Mixer Settler Agitator	3.4 m dia x 6.8 m	\$ 17,000	10	\$ 16,721	Lighthin	52	m <sup>3</sup>	10	0.85	8	354	m <sup>3</sup>	30	\$ 52,799	2	
1	400-AG-08	400	AG	08	Copper Stripping Mixer Settler Agitator	3.4 m dia x 6.8 m	\$ 17,000	10	\$ 16,721	Lighthin	52	m <sup>3</sup>	10	0.85	8	354	m <sup>3</sup>	30	\$ 52,799	2	
1	400-AG-09	400	AG	09	Scrubbing Mixer Settler Agitator	3.4 m dia x 6.8 m	\$ 9,000	8	\$ 8,455	Lighthin	52	m <sup>3</sup>	8	0.85	7	354	m <sup>3</sup>	11	\$ 11,423	2	
1	400-AG-11	400	AG	11	Crud Treatment Tank Agitator	2.8 m dia x 5.6 m	\$ 7,000	6	\$ 6,072	Lighthin	30	m <sup>3</sup>	6	0.85	5	86	m <sup>3</sup>	11	\$ 11,423	2	
1	400-AG-11	400	AG	11	Crud Treatment Tank Agitator	2.8 m dia x 5.6 m	\$ 7,000	6	\$ 6,072	Lighthin	30	m <sup>3</sup>	6	0.85	5	86	m <sup>3</sup>	11	\$ 11,423	2	
2	400-BN-01	400	BN	01	Copper Sulfate Product Bin		\$ 65,000		\$ 32,001	Local Fabrication	17	m <sup>3</sup>				74	m <sup>3</sup>		\$ 77,596	2	
1	400-CF-01	400	CF	01	Crud Centrifuge	Scroll Centrifuge	\$ 248,810	18	\$ 248,817		3	lhr	18	0.85	16	8	lhr	37	\$ 500,000	2	
1	400-CH-01	400	CH	01	Filter Press Discharge Chute	Constructed On Site	\$ 5,000	0	\$ 5,000	Local fabrication											4
1	400-CV-01	400	CV	01	Neutralised Tailings Transfer Conveyor	600 mm x 200 m x 10 m	\$ 360,000	21	\$ 360,000	Sarwest	4	lhr	21	0.85	18	1	m		\$ 1,800	2	
1	400-CV-02	400	CV	02	Striped Sheet Conveyor	600 mm x 20 m	\$ 36,000	11	\$ 36,000	Sarwest	2	lhr	11	0.85	9	1	m		\$ 1,800	2	
1	400-CV-03	400	CV	03	Cathode Discharge Conveyor	600 mm x 20 m	\$ 36,000	11	\$ 36,000	Sarwest	3	lhr	11	0.85	9	1	m		\$ 1,800	2	
1	400-CV-04	400	CV	04	Wet Copper Sulfate Conveyor	600 mm x 20 m	\$ 36,000	11	\$ 36,000	Sarwest	16	lhr	11	0.85	9	1	m		\$ 1,800	2	
1	400-CV-05	400	CV	05	Copper Sulfate Product Conveyor	600 mm x 20 m	\$ 36,000	11	\$ 36,000	Sarwest	5	lhr	11	0.85	9	1	m		\$ 1,800	2	
88	400-EC-01-88	400	EC	01-88	Electrowinning Cell		\$ 4,841,000	2195	\$ 4,840,452		7690	lpa		1.00	2195	11000	lpa		\$ 6,000,000	4	
1	400-FD-01	400	FD	01	Flash Drying Circuit		\$ 952,000	156	\$ 951,623	Swedala	16	lhr	156	0.85	133	10	lhr	120	\$ 730,000	4	
1	400-FE-01	400	FE	01	Flash Dryer Feeder		\$ 74,000	42	\$ 73,798		16	lhr	42	0.85	35	1	lhr	8	\$ 14,200	4	
2	400-FL-01-02	400	FL	01-02	pH Adjustment Filter Press	Pressure filter Diemme Me1500.2800.MB	\$ 85,000	20	\$ 42,413		3	lhr	10	0.85	17	50	lhr	50	\$ 214,286	2	
3	400-FL-03-05	400	FL	03-05	Polishing Filter	Candle Filter	\$ 920,000	142	\$ 920,364		656	m3/hr	47	0.85	121	720	m3/hr	50	\$ 324,000	2	
1	400-HE-01	400	HE	01	Heater and Cooling System	SX Feed Intercooler-MMFG	\$ 8,000	0	\$ 7,500	Alfa Laval											4
1	400-HE-02	400	HE	02	Heater and Cooling System	SX Feed Intercooler-MMFG	\$ 8,000	0	\$ 7,500	Alfa Laval											4
1	400-HE-03	400	HE	03	Heater and Cooling System	SX Feed Intercooler-MMFG	\$ 8,000	0	\$ 7,500	Alfa Laval											4
1	400-HE-04	400	HE	04	Heater and Cooling System	SX Feed Intercooler-MMFG	\$ 8,000	0	\$ 7,500	Alfa Laval											4
1	400-HE-05	400	HE	05	Heater and Cooling System	SX Feed Intercooler-MMFG	\$ 8,000	0	\$ 7,500	Alfa Laval											4
1	400-HE-06	400	HE	06	Heater and Cooling System	SX Feed Intercooler-MMFG	\$ 8,000	0	\$ 7,500	Alfa Laval											4
1	400-HE-07	400	HE	07	Heater and Cooling System	SX Feed Intercooler-MMFG	\$ 8,000	0	\$ 7,500	Alfa Laval											4
1	400-HE-08	400	HE	08	Heater and Cooling System	SX Feed Intercooler-MMFG	\$ 8,000	0	\$ 7,500	Alfa Laval											4
1	400-HE-09	400	HE	09	Heater and Cooling System	SX Feed Intercooler-MMFG	\$ 8,000	0	\$ 7,500	Alfa Laval											4
1	400-HE-10	400	HE	10	Heater and Cooling System	SX Feed Intercooler-MMFG	\$ 8,000	0	\$ 7,500	Alfa Laval											4
1	400-ME-01	400	ME	01	Crane		\$ 150,000	0	\$ 150,000												6
1	400-PK-01	400	PK	01	Copper Sulfate Crystalliser Vendor Package		\$ 1,250,000		\$ 1,250,000				150	0.85	128						6
1	400-PK-02	400	PK	02	Copper Sulfate Packaging Package		\$ 400,000		\$ 400,000				50	0.85	43						6
1	400-PP-01	400	PP	01	pH Adjustment Tank Pump (Duty)	MC 200-355	\$ 81,000	143	\$ 80,912	Weir	1971	m <sup>3</sup> /hr	143	0.75	107	402	m <sup>3</sup> /hr	55	\$ 31,170	2	
1	400-PP-02	400	PP	02	pH Adjustment Tank Pump (Standby)	MC 200-355	\$ 81,000	143	\$ 80,912	Weir	1971	m <sup>3</sup> /hr	143	0.00	0	402	m <sup>3</sup> /hr	55	\$ 31,170	2	
1	400-PP-03	400	PP	03	Thickener Underflow Pump (Duty)	MC 200-355	\$ 3,000	4	\$ 2,122	Weir	5	m <sup>3</sup> /hr	4	0.75	3	402	m <sup>3</sup> /hr	55	\$ 31,170	2	
1	400-PP-04	400	PP	04	Thickener Underflow Pump (Standby)	MC 200-355	\$ 3,000	4	\$ 2,122	Weir	5	m <sup>3</sup> /hr	4	0.00	0	402	m <sup>3</sup> /hr	55	\$ 31,170	2	
1	400-PP-05	400	PP	05	Filtrate Recycling Pump (Duty)	MC 200-355	\$ 2,000	3	\$ 1,766	Weir	3	m <sup>3</sup> /hr	3	0.75	2	402	m <sup>3</sup> /hr	55	\$ 31,170	2	
1	400-PP-06	400	PP	06	Filtrate Recycling Pump (Standby)	MC 200-355	\$ 2,000	3	\$ 1,766	Weir	3	m <sup>3</sup> /hr	3	0.00	0	402	m <sup>3</sup> /hr	55	\$ 31,170	2	
1	400-PP-07	400	PP	07	Polishing Filter Pump (Duty)	MC 200-355	\$ 81,000	143	\$ 80,829	Weir	1968	m <sup>3</sup> /hr	143	0.75	107	402	m <sup>3</sup> /hr	55	\$ 31,170	2	
1	400-PP-08	400	PP	08	Polishing Filter Pump (Standby)	MC 200-355	\$ 81,000	143	\$ 80,829	Weir	1968	m <sup>3</sup> /hr	143	0.00	0	402	m <sup>3</sup> /hr	55	\$ 31,170	2	
1	400-PP-09	400	PP	09	Copper SX PLS Feed Pump (Duty)	MC 200-355	\$ 81,000	143	\$ 80,829	Weir	1968	m <sup>3</sup> /hr	143	0.75	107	402	m <sup>3</sup> /hr	55	\$ 31,170	2	
1	400-PP-10	400	PP	10	Copper SX PLS Feed Pump (Standby)	MC 200-355	\$ 81,000	143	\$ 80,829	Weir	1968	m <sup>3</sup> /hr	143	0.00	0	402	m <sup>3</sup> /hr	55	\$ 31,170	2	
1	400-PP-11	400	PP	11	Organic Transfer Pump (Duty)	MC 200-355	\$ 81,000	143	\$ 80,829	Weir	1968	m <sup>3</sup> /hr	143	0.75	107	402	m <sup>3</sup> /hr	55	\$ 31,170	2	
1	400-PP-12	400	PP	12	Organic Transfer Pump (Standby)	MC 200-355	\$ 81,000	143	\$ 80,829	Weir	1968	m <sup>3</sup> /hr	143	0.00	0	402	m <sup>3</sup> /hr	55	\$ 31,170	2	
1	400-PP-13	400	PP	13	Copper Extraction Crud Transfer Pump (Duty)	Peristaltic Pump	\$ 6,000	1	\$ 5,404	Flowrex	1	m <sup>3</sup> /hr	1	0.75	1	0.53	m <sup>3</sup> /hr	0.75	\$ 3,692	2	
1	400-PP-14	400	PP	14	Copper Extraction Crud Transfer Pump (Standby)	Peristaltic Pump	\$ 6,000	1	\$ 5,404	Flowrex	1	m <sup>3</sup> /hr	1	0.00	0	0.53	m <sup>3</sup> /hr	0.75	\$ 3,692	2	
1	400-PP-15	400	PP	15	Raffinate Pump (Duty)	MC 200-355	\$ 81,000	143	\$ 80,829	Weir	1968	m <sup>3</sup> /hr	143	0.75	107	402	m <sup>3</sup> /hr	55	\$ 31,170	2	
1	400-PP-16	400	PP	16	Raffinate Pump (Standby)	MC 200-355	\$ 81,000	143	\$ 80,829	Weir	1968	m <sup>3</sup> /hr	143	0.00	0	402	m <sup>3</sup> /hr	55	\$ 31,170	2	
1	400-PP-17	400	PP	17	Loaded Organic Pump (Duty)	MC 200-355	\$ 81,000	78	\$ 80,829	Weir	1968	m <sup>3</sup> /hr	78	0.75	58	402	m <sup>3</sup> /hr	30	\$ 31,170	2	
1	400-PP-18	400	PP	18	Loaded Organic Pump (Standby)	MC 200-355	\$ 81,000	78	\$ 80,829	Weir	1968	m <sup>3</sup> /hr	78	0.00	0	402	m <sup>3</sup> /hr	30	\$ 31,170	2	
1	400-PP-19	400	PP	19	Copper Extraction Crud Transfer Pump (Duty)	Peristaltic Pump	\$ 6,000	1	\$ 5,404	Flowrex	1	m <sup>3</sup> /hr	1	0.75	1	0.53	m <sup>3</sup> /hr	0.75	\$ 3,692	2	
1	400-PP-20	400	PP	20	Copper Extraction Crud Transfer Pump (Standby)	Peristaltic Pump	\$ 6,000	1	\$ 5,404	Flowrex	1	m <sup>3</sup> /hr	1	0.00	0	0.53	m <sup>3</sup> /hr	0.75	\$ 3,692	2	
1	400-PP-21	400	PP	21	Raffinate Pump (Duty)	GEKONORM NM 32-160	\$ 29,000	19	\$ 28,732	Weir	1968	m <sup>3</sup> /hr	19	0.75	15	402	m <sup>3</sup> /hr	7.5	\$ 11,080	2	
1	400-PP-22	400	PP	22	Raffinate Pump (Standby)	GEKONORM NM 32-160	\$ 29,000	19	\$ 28,732	Weir	1968	m <sup>3</sup> /hr	19	0.00	0	402	m <sup>3</sup> /hr	7.5	\$ 11,080	2	
1	400-PP-23	400	PP	23	Loaded Organic Pump (Duty)	MC 200-355	\$ 81,000	78	\$ 80,829	Weir	1968	m <sup>3</sup> /hr	78	0.75	58	402	m <sup>3</sup> /hr	30	\$ 31,170	2	
1	400-PP-24	400	PP	24	Loaded Organic Pump (Standby)	MC 200-355	\$ 81,000	78	\$ 80,829	Weir	1968	m <sup>3</sup> /hr	78	0.00	0	402	m <sup>3</sup> /hr	30	\$ 31,170	2	
1	400-PP-25	400	PP	25	Stripping Feed Pump (Duty)	MC 200-355	\$ 81,000	143	\$ 80,829	Weir	1968	m <sup>3</sup> /hr	143	0.75	107	402	m <sup>3</sup> /hr	55	\$ 31,170	2	
1	400-PP-26	400	PP	26	Stripping Feed Pump (Standby)	MC 200-355	\$ 81,000	143	\$ 80,829	Weir	1968	m <sup>3</sup> /hr	143	0.00	0	402	m <sup>3</sup> /hr	55	\$ 31,170	2	
1	400-PP-27	400	PP	27	Stripping Liquor Pump (Duty)	GEKONORM NM 32-160	\$ 6,000	4	\$ 5,255	Weir	116	m <sup>3</sup> /hr	4								

Quantity	Equipment Number	Area Number	Equipment	Tag	Description	Model/Type (equivalent or similar)	Equipment Price (USD)	Estimated Power (kW)	Scaled Cost USD	Supplier	Scaled Capacity	Units	Scaled Power (kW)	Diversity	Diversified Power (kW)	Basis Capacity	Units	Basis Power (kW)	Basis Cost (USD)	Reference		
1	400-PP-49	400	PP	49	Crud Treatment Tank Discharge Pump (Duty)	Peristaltic Pump	\$ 15,000	3	\$ 14,193	Flowrec	5	m <sup>3</sup> /h	3	0.75	2	0.53	m <sup>3</sup> /h	0.75	\$ 3,662	2		
1	400-PP-50	400	PP	50	Crud Treatment Tank Discharge Pump (Standby)	Peristaltic Pump	\$ 15,000	3	\$ 14,193	Flowrec	5	m <sup>3</sup> /h	3	0.00	0	0.53	m <sup>3</sup> /h	0.75	\$ 3,662	2		
1	400-PP-51	400	PP	51	Certrate Recycle Pump (Duty)	MC 200-355	\$ 3,000	4	\$ 2,242	Weir	5	m <sup>3</sup> /h	4	0.75	3	402	m <sup>3</sup> /h	55	\$ 31,170	2		
1	400-PP-52	400	PP	52	Certrate Recycle Pump (Standby)	MC 200-355	\$ 3,000	4	\$ 2,242	Weir	5	m <sup>3</sup> /h	4	0.00	0	402	m <sup>3</sup> /h	55	\$ 31,170	2		
1	400-PP-53	400	PP	53	Electrowinning Feed Pump (Duty)		\$ 5,000	1	\$ 4,436	Weir	37	m <sup>3</sup> /h	1	0.75	1	75	m <sup>3</sup> /h	1.1	\$ 6,752	2		
1	400-PP-54	400	PP	54	Electrowinning Feed Pump (Standby)		\$ 5,000	1	\$ 4,436	Weir	37	m <sup>3</sup> /h	1	0.00	0	75	m <sup>3</sup> /h	1.1	\$ 6,752	2		
1	400-PP-55	400	PP	55	Electrowinning Discharge Pump (Duty)		\$ 5,000	1	\$ 4,436	Weir	37	m <sup>3</sup> /h	1	0.75	1	75	m <sup>3</sup> /h	1.1	\$ 6,752	2		
1	400-PP-56	400	PP	56	Electrowinning Discharge Pump (Standby)		\$ 5,000	1	\$ 4,436	Weir	37	m <sup>3</sup> /h	1	0.00	0	75	m <sup>3</sup> /h	1.1	\$ 6,752	2		
1	400-PP-57	400	PP	57	Cathode Washing Tank Discharge Pump (Duty)		\$ 3,000	0	\$ 2,869	Weir	18	m <sup>3</sup> /h	0.5	0.75	0	75	m <sup>3</sup> /h	1.1	\$ 6,752	2		
1	400-PP-58	400	PP	58	Cathode Washing Tank Discharge Pump (Standby)		\$ 3,000	0	\$ 2,869	Weir	18	m <sup>3</sup> /h	0.5	0.00	0	75	m <sup>3</sup> /h	1.1	\$ 6,752	2		
1	400-PP-59	400	PP	59	Stripping Liquor Return Pump (Duty)		\$ 5,000	1	\$ 4,436	Weir	37	m <sup>3</sup> /h	0.7	0.75	1	75	m <sup>3</sup> /h	1.1	\$ 6,752	2		
1	400-PP-60	400	PP	60	Stripping Liquor Return Pump (Standby)	GL1304 Steel 6.02m D x 4.27m, 122kL	\$ 5,000	1	\$ 4,436	Weir	37	m <sup>3</sup> /h	0.7	0.00	0	75	m <sup>3</sup> /h	1.1	\$ 6,752	2		
1	400-PP-61	400	PP	61	Crystalliser Feed Pump (Duty)		\$ 7,000	1	\$ 6,006	Weir	62	m <sup>3</sup> /h	1	0.75	1	75	m <sup>3</sup> /h	1.1	\$ 6,752	2		
1	400-PP-62	400	PP	62	Crystalliser Feed Pump (Standby)		\$ 7,000	1	\$ 6,006	Weir	62	m <sup>3</sup> /h	1	0.00	0	75	m <sup>3</sup> /h	1.1	\$ 6,752	2		
1	400-PP-63	400	PP	63	Stripping Liquor Return Pump (Duty)		\$ 6,000	1	\$ 5,135	Weir	48	m <sup>3</sup> /h	0.8	0.75	1	75	m <sup>3</sup> /h	1.1	\$ 6,752	2		
1	400-PP-64	400	PP	64	Stripping Liquor Return Pump (Standby)		\$ 6,000	1	\$ 5,135	Weir	48	m <sup>3</sup> /h	0.8	0.00	0	75	m <sup>3</sup> /h	1.1	\$ 6,752	2		
1	400-PS-01	400	PS	01	Copper EX Mixer Settle Pump		\$ 12,000	0	\$ 11,106											4		
1	400-PS-02	400	PS	02	Copper Stripping Mixer Settle Pump		\$ 12,000	0	\$ 11,106												4	
1	400-PS-03	400	PS	03	Scrubbing Sump Pump		\$ 12,000	0	\$ 11,106												4	
1	400-PS-04	400	PS	04	Electrowinning Sump Pump		\$ 12,000	0	\$ 11,106												4	
1	400-PS-05	400	PS	05	Crystalliser Sump Pump		\$ 12,000	0	\$ 11,106												4	
14	400-SH-01-14	400	SH	01-14	Safety Shower and Eyewash Station		\$ 14,000	0	\$ 1,900												4	
1	400-SX-01	400	SX	01	Scrubbing Mixer Settle	settle, DOP tank, Mixer tank	\$ 798,000	32	\$ 735,740	Outotec	492	m <sup>3</sup> /h	32	0.75	24	442	m <sup>3</sup> /h	30	\$ 690,000	2		
1	400-SX-02	400	SX	02	Copper Extraction Mixer Settle	settle, DOP tank, Mixer tank	\$ 2,853,000	78	\$ 2,852,472	Outotec	3935	m <sup>3</sup> /h	78	0.75	58	804	m <sup>3</sup> /h	30	\$ 1,100,000	2		
1	400-SX-03	400	SX	03	Copper Extraction Mixer Settle	settle, DOP tank, Mixer tank	\$ 2,853,000	78	\$ 2,852,472	Outotec	3935	m <sup>3</sup> /h	78	0.75	58	804	m <sup>3</sup> /h	30	\$ 1,100,000	2		
1	400-SX-04	400	SX	04	Copper Stripping Mixer Settle	settle, DOP tank, Mixer tank	\$ 1,750,000	38	\$ 1,749,359	Outotec	2084	m <sup>3</sup> /h	38	0.75	29	442	m <sup>3</sup> /h	15	\$ 690,000	2		
1	400-SX-05	400	SX	05	Copper Stripping Mixer Settle	settle, DOP tank, Mixer tank	\$ 1,750,000	38	\$ 1,749,359	Outotec	2084	m <sup>3</sup> /h	38	0.75	29	442	m <sup>3</sup> /h	15	\$ 690,000	2		
1	400-TH-01	400	TH	01	pH Adjustment Thickener		\$ 232,000	0	\$ 231,631	Waterex	6	m				20	m		\$ 499,800	2		
1	400-TK-01	400	TK	01	pH Adjustment Tank	GL1304 Steel 6.02m D x 4.27m, 122kL	\$ 149,000	0	\$ 148,882	Pioneer	164	m <sup>3</sup>				390	m <sup>3</sup>		\$ 250,000	2		
1	400-TK-02	400	TK	02	SX PLS Feed Tank	GL1304 Steel 6.02m D x 4.27m, 122kL	\$ 228,000	0	\$ 225,663	Pioneer	329	m <sup>3</sup>				390	m <sup>3</sup>		\$ 250,000	2		
1	400-TK-03	400	TK	03	Organic Control Tank	GL1304 Steel 6.02m D x 4.27m, 122kL	\$ 28,000	0	\$ 27,963	Pioneer	164	m <sup>3</sup>				122	m <sup>3</sup>		\$ 23,381	2		
1	400-TK-04	400	TK	04	Loaded Organic Tank	GL1304 Steel 6.02m D x 4.27m, 122kL	\$ 28,000	0	\$ 27,963	Pioneer	164	m <sup>3</sup>				122	m <sup>3</sup>		\$ 23,381	2		
1	400-TK-05	400	TK	05	Strip Liquor Makeup Tank	GL1304 Steel 6.02m D x 4.27m, 122kL	\$ 14,000	0	\$ 13,159	Pioneer	11	m <sup>3</sup>				50	m <sup>3</sup>		\$ 33,000	2		
1	400-TK-06	400	TK	06	Scrubbing Solution Makeup Tank	GL1304 Steel 6.02m D x 4.27m, 122kL	\$ 149,000	0	\$ 148,882	Pioneer	164	m <sup>3</sup>				390	m <sup>3</sup>		\$ 250,000	2		
1	400-TK-07	400	TK	07	PLS Tank	GL1304 Steel 6.02m D x 4.27m, 122kL	\$ 149,000	0	\$ 148,882	Pioneer	164	m <sup>3</sup>				390	m <sup>3</sup>		\$ 250,000	2		
1	400-TK-08	400	TK	08	SX Waste Tank	GL1304 Steel 6.02m D x 4.27m, 122kL	\$ 3,000	0	\$ 2,859	Pioneer	1	m <sup>3</sup>				50	m <sup>3</sup>		\$ 33,000	2		
1	400-TK-09	400	TK	09	Crud Treatment Tank	GL1304 Steel 6.02m D x 4.27m, 122kL	\$ 13,000	0	\$ 12,664	Pioneer	10	m <sup>3</sup>				50	m <sup>3</sup>		\$ 33,000	2		
1	400-TK-10	400	TK	10	Certrate Collection Tank	GL1304 Steel 6.02m D x 4.27m, 122kL	\$ 13,000	0	\$ 12,664	Pioneer	10	m <sup>3</sup>				50	m <sup>3</sup>		\$ 33,000	2		
1	400-TK-11	400	TK	11	Cathode Washing Tank	GL1304 Steel 6.02m D x 4.27m, 122kL	\$ 117,000	0	\$ 116,798	Pioneer	164	m <sup>3</sup>				20	m <sup>3</sup>		\$ 33,000	2		
1	400-TK-12	400	TK	12	Stripping Liquor Tank	GL1304 Steel 6.02m D x 4.27m, 122kL	\$ 14,000	0	\$ 13,159	Pioneer	11	m <sup>3</sup>				50	m <sup>3</sup>		\$ 33,000	2		
1	400-XM-01	400	XM	01	Cathode Flexing Station		\$ 50,000	0	\$ 50,000												4	
1	400-XM-02	400	XM	02	Cathode Stripping Station		\$ 80,000	0	\$ 80,000													4
1	400-XM-03	400	XM	03	Cathode Waxing Station		\$ 50,000	0	\$ 50,000													4
1	400-XM-04	400	XM	04	Cathode Strapping Station		\$ 80,000	0	\$ 80,000													4
1	400-XM-05	400	XM	05	Cathode Punch Station		\$ 50,000	0	\$ 50,000													4
1	400-XM-06	400	XM	06	Cathode Weighing Station		\$ 80,000	0	\$ 80,000													4
1	400-YTR-01	400	YTR	01	Foam/CO2 Free Truck (for SX)		\$ 200,000	0	\$ 200,000													6
1	400-YTR-02	400	YTR	02	Copper Product Flatbed Truck		\$ 120,000	0	\$ 120,000													6
1	500-AG-01	500	AG	01	Precipitation Tank Agitator	5 m dia x 10 m	\$ 30,000	17	\$ 29,212	Mixtec	132	m <sup>2</sup>	17	0.85	14	354	m <sup>2</sup>	30	\$ 52,799	2		
1	500-AG-02	500	AG	02	Iron Tailings Filter Feed Tank Agitator	5 m dia x 10 m	\$ 30,000	17	\$ 29,212	Mixtec	132	m <sup>2</sup>	17	0.85	14	354	m <sup>2</sup>	30	\$ 52,799	2		
2	500-CH-01-02	500	CH	01-02	Filter Press Discharge Chute	Constructed On Site	\$ 9,000	0	\$ 4,500	Local Fabrication												4
1	500-CV-01	500	CV	01	Filter Press Discharge Conveyor	600 mm x 50 m x 10 m	\$ 90,000	22	\$ 90,000	Sarnest	92	th	22	0.85	19	1	m		\$ 1,800	2		
1	500-CV-02	500	CV	02	Tailing Handling Conveyor	Rail Mounted Radial Stacker, 600 mm x 50 m x 15 m	\$ 108,000	22	\$ 107,744	Krupp	100	th	22	0.85	19	1750	th		\$ 600,000	2		
2	500-FL-01-02	500	FL	01-02	Iron Tailings Filter Press		\$ 371,000	86	\$ 185,032		39	th	43	0.85	73	50	th	50	\$ 214,286	2		
1	500-PP-01	500	PP	01	Precipitation Tank Pump (Duty)	SDB 200/250/Centrifugal	\$ 12,000	32	\$ 11,464	Weir	132	m <sup>3</sup> /h	32	0.75	24	1400	m <sup>3</sup> /h	132	\$ 47,279	2		
1	500-PP-02	500	PP	02	Precipitation Tank Pump (Standby)	SDB 200/250/Centrifugal	\$ 12,000	32	\$ 11,464	Weir	132	m <sup>3</sup> /h	32	0.00	0	1400	m <sup>3</sup> /h	132	\$ 47,279	2		
1	500-PP-03	500	PP	03	Thickener U/F Pump (Duty)	SDB 200/250/Centrifugal	\$ 11,000	28	\$ 10,065	Weir	106	m <sup>3</sup> /h	28	0.75	21	1400	m <sup>3</sup> /h	132	\$ 47,279	2		
1	500-PP-04	500	PP	04	Thickener U/F Pump (Standby)	SDB 200/250/Centrifugal	\$ 11,000	28	\$ 10,065	Weir	106	m <sup>3</sup> /h	28	0.00	0	1400	m <sup>3</sup> /h	132	\$ 47,279	2		
1	500-PP-05	500	PP	05	Barnes Solution Pond Feed Pump (Duty)	Warman 3k2AH	\$ 24,000	14	\$ 23,871	Weir	726	m <sup>3</sup> /h	14	0.75	11	150	m <sup>3</sup> /h	5.5	\$ 9,188	2		
1	500-PP-06	500	PP	06	Barnes Solution Pond Feed Pump (Standby)	Warman 3k2AH	\$ 24,000	14	\$ 23,871	Weir	726	m <sup>3</sup> /h										

Quantity	Equipment Number	Area Number	Equipment	Tag	Description	Model/Type (equivalent or similar)	Equipment Price (USD)	Estimated Power (kW)	Scaled Cost USD	Supplier	Scaled Capacity	Units	Scaled Power (kW)	Diversity	Diversified Power (kW)	Basis Capacity	Units	Basis Power (kW)	Basis Cost (USD)	Reference
1	600-PP-11	600	PP	11	Jockey Fire Pump	Water Pump	\$ 4,000	11	\$ 3,338	Linatex	35	m <sup>3</sup> /h	11	0.75	8	35	m <sup>3</sup> /h	11	\$ 3,338	4
1	600-PP-12	600	PP	12	Gland Seal Water Distribution Pump (Duty)		\$ 2,000	5	\$ 1,574		10	m <sup>3</sup> /h	5	0.75	4	35	m <sup>3</sup> /h	11	\$ 3,338	2
1	600-PP-13	600	PP	13	Gland Seal Water Distribution Pump (Standby)		\$ 2,000	5	\$ 1,574		10	m <sup>3</sup> /h	5	0.00	0	35	m <sup>3</sup> /h	11	\$ 3,338	2
1	600-PP-14	600	PP	14	Raw Water Distribution Pump (Duty)	Water Pump	\$ 9,000	28	\$ 8,545	Linatex	168	m <sup>3</sup> /h	28	0.75	21	35	m <sup>3</sup> /h	11	\$ 3,338	2
1	600-PP-15	600	PP	15	Raw Water Distribution Pump (Standby)	Water Pump	\$ 9,000	28	\$ 8,545	Linatex	168	m <sup>3</sup> /h	28	0.00	0	35	m <sup>3</sup> /h	11	\$ 3,338	2
1	600-TK-01	600	TK	01	Process Water Distribution Tank-Mining Area	Steel Tank with rubber liners, colourbond finish	\$ 78,000	0	\$ 77,383	Pioneer	360	m <sup>3</sup>				2660	m <sup>3</sup>		\$ 256,916	2
1	600-TK-02	600	TK	02	Raw Water Distribution Tank	Water Tank	\$ 333,000	0	\$ 332,092	Pioneer	4080	m <sup>3</sup>				2660	m <sup>3</sup>		\$ 256,916	4
1	600-TK-03	600	TK	03	Process Water Distribution Tank-Processing Area	Steel Tank with rubber liners, colourbond finish	\$ 204,000	0	\$ 203,248	Pioneer	1800	m <sup>3</sup>				2660	m <sup>3</sup>		\$ 256,916	2
1	700-AG-01	700	AG	01	Lime Slurry Distribution Tank Agitator	1.4 m dia x 2.8 m	\$ 2,000	1	\$ 1,378	Miltec	4	m <sup>2</sup>	1	0.85	1	33	m <sup>2</sup>	2.2	\$ 4,829	2
1	700-AG-02	700	AG	02	Limestone/Calccrete Slurry Distribution Tank Agitator	3.4 m dia x 6.8 m	\$ 4,000	4	\$ 3,909	Miltec	14	m <sup>2</sup>	4	0.85	3	86	m <sup>2</sup>	1.1	\$ 11,423	2
1	700-AG-03	700	AG	03	LX Mixing Tank Agitator	1m dia x 2 m	\$ 1,000	0	\$ 961	Miltec	1.2	m <sup>2</sup>	0.3	0.85	0	33	m <sup>2</sup>	2.2	\$ 4,829	2
1	700-BN-01	700	BN	01	Quicklime Feed Silo		\$ 114,000	0	\$ 113,008	Local Fabrication	26	m <sup>3</sup>				100	m <sup>3</sup>		\$ 251,273	2
1	700-BN-02	700	BN	02	Limestone/Calccrete Feed Silo		\$ 142,000	0	\$ 141,496	Local Fabrication	38	m <sup>3</sup>				100	m <sup>3</sup>		\$ 251,273	2
1	700-FE-01	700	FE	01	Quicklime Feeder	Belt Feeder	\$ 4,000	2	\$ 3,026	Metsu	0.9	lhr	2	0.75	2	320	lhr	10	\$ 100,500	3
1	700-FE-02	700	FE	02	Limestone/Calccrete Feeder	Belt Feeder	\$ 8,000	1	\$ 7,396	Metsu	4.1	lhr	1	0.75	1	320	lhr	10	\$ 100,500	3
1	700-MH-01	700	MH	01	Bulk Bag Monorail and Hoist		\$ 18,000	0	\$ 18,000	Eilbeck Cranes										2
1	700-ME-01	700	ME	01	Forklift		\$ 30,000	0	\$ 30,000											6
1	700-ME-02	700	ME	02	Crane		\$ 150,000	0	\$ 150,000											6
1	700-ME-03	700	ME	03	Crane		\$ 150,000	0	\$ 150,000											6
1	700-PP-01	700	PP	01	Lime Slaking Mill		\$ 450,000	0	\$ 450,000											2
1	700-PP-02	700	PP	02	Quartz Gum Vendor Package		\$ 250,000	0	\$ 250,000											4
1	700-PP-03	700	PP	03	Cobalt Sulphate Vendor Package		\$ 50,000	0	\$ 50,000											4
1	700-PP-04	700	PP	04	Polyacrylamide Vendor Package		\$ 250,000	0	\$ 250,000											4
1	700-PP-05	700	PP	05	Flocculant Vendor Package		\$ 71,000	2	\$ 70,067	Transmin	8.17	kg/hr	2	0.50	1	218	kg/hr	15	\$ 502,785	2
1	700-PP-01	700	PP	01	Lime Transfer Pump (Duty)		\$ 4,000	1	\$ 4,000	Allied Colloids	0.9	m <sup>3</sup> /h	0.1	0.75	0	75	m <sup>3</sup> /h	1.1	\$ 6,752	2
1	700-PP-02	700	PP	02	Lime Transfer Pump (Standby)		\$ 4,000	1	\$ 4,000	Allied Colloids	0.9	m <sup>3</sup> /h	0.1	0.00	0	75	m <sup>3</sup> /h	1.1	\$ 6,752	2
1	700-PP-03	700	PP	03	Lime Metering Pump (Duty)		\$ 4,000	1	\$ 4,000	Allied Colloids	0.9	m <sup>3</sup> /h	0.1	0.75	0	75	m <sup>3</sup> /h	1.1	\$ 6,752	2
1	700-PP-04	700	PP	04	Lime Metering Pump (Standby)		\$ 4,000	1	\$ 4,000	Allied Colloids	0.9	m <sup>3</sup> /h	0.1	0.00	0	75	m <sup>3</sup> /h	1.1	\$ 6,752	2
1	700-PP-05	700	PP	05	Lime Metering Pump (Duty)		\$ 4,000	1	\$ 4,000	Allied Colloids	0.9	m <sup>3</sup> /h	0.08	0.75	0	75	m <sup>3</sup> /h	1.1	\$ 6,752	2
1	700-PP-06	700	PP	06	Lime Metering Pump (Standby)		\$ 4,000	1	\$ 4,000	Allied Colloids	0.9	m <sup>3</sup> /h	0.08	0.00	0	75	m <sup>3</sup> /h	1.1	\$ 6,752	2
1	700-PP-07	700	PP	07	Lime Metering Pump (Duty)		\$ 4,000	1	\$ 4,000	Allied Colloids	0.9	m <sup>3</sup> /h	0.1	0.75	0	75	m <sup>3</sup> /h	1.1	\$ 6,752	2
1	700-PP-08	700	PP	08	Lime Metering Pump (Standby)		\$ 4,000	1	\$ 4,000	Allied Colloids	0.9	m <sup>3</sup> /h	0.1	0.00	0	75	m <sup>3</sup> /h	1.1	\$ 6,752	2
1	700-PP-09	700	PP	09	Limestone Metering Pump (Duty)		\$ 14,000	1	\$ 14,000	Allied Colloids	4.1	m <sup>3</sup> /h	0.2	0.75	0	75	m <sup>3</sup> /h	1.1	\$ 6,752	2
1	700-PP-10	700	PP	10	Limestone Metering Pump (Standby)		\$ 14,000	1	\$ 14,000	Allied Colloids	4.1	m <sup>3</sup> /h	0.2	0.00	0	75	m <sup>3</sup> /h	1.1	\$ 6,752	2
1	700-PP-11	700	PP	11	Limestone Metering Pump (Duty)		\$ 14,000	1	\$ 14,000	Allied Colloids	4.1	m <sup>3</sup> /h	0.20	0.75	0	75	m <sup>3</sup> /h	1.1	\$ 6,752	2
1	700-PP-12	700	PP	12	Limestone Metering Pump (Standby)		\$ 14,000	1	\$ 14,000	Allied Colloids	4.1	m <sup>3</sup> /h	0.20	0.00	0	75	m <sup>3</sup> /h	1.1	\$ 6,752	2
1	700-PP-13	700	PP	13	Limestone Metering Pump (Duty)		\$ 14,000	1	\$ 14,000	Allied Colloids	4.1	m <sup>3</sup> /h	0.2	0.75	0	75	m <sup>3</sup> /h	1.1	\$ 6,752	2
1	700-PP-14	700	PP	14	Limestone Metering Pump (Standby)		\$ 14,000	1	\$ 14,000	Allied Colloids	4.1	m <sup>3</sup> /h	0.2	0.00	0	75	m <sup>3</sup> /h	1.1	\$ 6,752	2
1	700-PP-15	700	PP	15	Acid Metering Pump (Duty)		\$ 37,000	6	\$ 36,640		2.3	m <sup>3</sup> /h	6	0.75	5	0.037	m <sup>3</sup> /h	0.55	\$ 3,111	2
1	700-PP-16	700	PP	16	Acid Metering Pump (Standby)		\$ 37,000	6	\$ 36,640		2.3	m <sup>3</sup> /h	6	0.00	0	0.037	m <sup>3</sup> /h	0.55	\$ 3,111	2
1	700-PP-17	700	PP	17	Acid Metering Pump (Duty)		\$ 37,000	6	\$ 36,640		2.3	m <sup>3</sup> /h	6	0.75	5	0.037	m <sup>3</sup> /h	0.55	\$ 3,111	2
1	700-PP-18	700	PP	18	Acid Metering Pump (Standby)		\$ 37,000	6	\$ 36,640		2.3	m <sup>3</sup> /h	6	0.00	0	0.037	m <sup>3</sup> /h	0.55	\$ 3,111	2
1	700-PP-19	700	PP	19	Acid Metering Pump (Duty)		\$ 37,000	6	\$ 36,640		2.3	m <sup>3</sup> /h	6.48	0.75	5	0.037	m <sup>3</sup> /h	0.55	\$ 3,111	2
1	700-PP-20	700	PP	20	Acid Metering Pump (Standby)		\$ 37,000	6	\$ 36,640		2.3	m <sup>3</sup> /h	6.48	0.00	0	0.037	m <sup>3</sup> /h	0.55	\$ 3,111	2
1	700-PP-21	700	PP	21	Acid Metering Pump (Duty)		\$ 37,000	6	\$ 36,640		2.3	m <sup>3</sup> /h	6	0.75	5	0.037	m <sup>3</sup> /h	0.55	\$ 3,111	2
1	700-PP-22	700	PP	22	Acid Metering Pump (Standby)		\$ 37,000	6	\$ 36,640		2.3	m <sup>3</sup> /h	6	0.00	0	0.037	m <sup>3</sup> /h	0.55	\$ 3,111	2
1	700-PP-23	700	PP	23	LX Transfer Pump (Duty)		\$ 8,800	1	\$ 8,800	Allied Colloids	30	L	1.0	0.75	1					2
1	700-PP-24	700	PP	24	LX Transfer Pump (Standby)		\$ 8,800	1	\$ 8,800	Allied Colloids	30	L	1.0	0.00	0					2
1	700-PP-25	700	PP	25	LX Metering Pump (Duty)		\$ 8,800	1	\$ 8,800	Allied Colloids	30	L	1.0	0.75	1					2
1	700-PP-26	700	PP	26	LX Metering Pump (Standby)		\$ 8,800	1	\$ 8,800	Allied Colloids	30	L	1.0	0.00	0					2
1	700-PP-27	700	PP	27	Kerosene Metering Pump (Duty)	Mono B021 in 316 S.S.	\$ 13,000	1	\$ 13,000	Challenge	201	L	1.0	0.75	1					2
1	700-PP-28	700	PP	28	Kerosene Metering Pump (Standby)	Mono B021 in 316 S.S.	\$ 13,000	1	\$ 13,000	Challenge	201	L	1.0	0.00	0					2
1	700-PP-29	700	PP	29	Kerosene Metering Pump (Duty)	Mono B021 in 316 S.S.	\$ 13,000	1	\$ 13,000	Challenge	201	L	1.0	0.75	1					2
1	700-PP-30	700	PP	30	Kerosene Metering Pump (Standby)	Mono B021 in 316 S.S.	\$ 13,000	1	\$ 13,000	Challenge	201	L	1.0	0.00	0					2
1	700-PS-01	700	PS	01	Lime Sump Pump		\$ 12,000	0	\$ 11,106											4
1	700-PS-02	700	PS	02	Limestone Sump Pump		\$ 12,000	0	\$ 11,106											4
1	700-PS-03	700	PS	03	Acid Sump Pump		\$ 12,000	0	\$ 11,106											4
1	700-PS-04	700	PS	04	LX Sump Pump		\$ 12,000	0	\$ 11,106											4
1	700-PS-05	700	PS	05	Quartz Gum Sump Pump		\$ 12,000	0	\$ 11,106											4
1	700-PS-06	700	PS	06	Cobalt Sulphate Sump Pump		\$ 12,000	0	\$ 11,106											4
1	700-PS-07	700	PS	07	Kerosene Sump Pump		\$ 12,000	0	\$ 11,106											4
1	700-PS-08	700	PS	08	Polyacrylamide Sump Pump		\$ 12,000	0	\$ 11,106											4
1	700-PS-09	700	PS	09	Flocculant Sump Pump		\$ 12,000	0	\$ 11,106											4
1	700-SH-01	700	SH	01	Safety Shower & Eye Wash Station		\$ 4,000	0	\$ 4,000											4
1	700-SH-02	700	SH	02	Safety Shower & Eye Wash Station		\$ 4,000	0	\$ 4,000											4
1	700-SH-03	700	SH	03	Safety Shower & Eye Wash Station		\$ 4,000	0	\$ 4,000											4
1	700-SHD-01	700	SHD	01	Reagent Shed	12x32x6 (w x l x h)	\$ 160,000	0	\$ 160,000											6
1	700-TK-01	700	TK	01	Lime Slurry Distribution Tank	Steel Tank c/w liner, colour bond finish	\$ 7,000	0	\$ 6,806	Pioneer	4	m <sup>3</sup>				50	m <sup>3</sup>		\$ 33,000	2
1	700-TK-02	700	TK	02	Limestone Slurry Distribution Tank	Steel Tank c/w liner, colour bond finish	\$ 16,000	0	\$ 15,637	Pioneer	14	m <sup>3</sup>				50	m <sup>3</sup>		\$ 33,000	2
1	700-TK-03	700	TK	03	Acid Storage Tank	Steel Tank c/w liner, colour bond finish	\$ 78,000	0	\$ 77,351	Pioneer	55	m <sup>3</sup>				390	m <sup>3</sup>		\$ 250,000	2
1	700-TK-04	700	TK	04	LX Mixing Tank	Steel Tank c/w liner, colour bond finish	\$ 5,000	0	\$ 4,962	Pioneer	1.2	m <sup>3</sup>				34	m <sup>3</sup>		\$ 30,954	2
1	700-TK-05	700	TK	05	Kerosene Distribution Tank	Steel Tank c/w liner, colour bond finish	\$ 11,000	0	\$ 10,933	Pioneer	6	m <sup>3</sup>				34	m <sup>3</sup>		\$ 30,954	2
1	800-CP-01</																			

Quantity	Equipment Number	Area Number	Equipment	Tag	Description	Model/Type (equivalent or similar)	Equipment Price (USD)	Estimated Power (kW)	Scaled Cost USD	Supplier	Scaled Capacity	Units	Scaled Power (kW)	Diversity	Diversified Power (kW)	Basis Capacity	Units	Basis Power (kW)	Basis Cost (USD)	Reference	
1	800-PP-06	800	PP	06	Safety Shower Pump (Duty)-Mining Area		\$ 3,000	1	\$ 2,503											4	
1	800-PP-07	800	PP	07	Safety Shower Pump (Standby)-Mining Area		\$ 3,000	1	\$ 2,503											4	
1	800-PP-08	800	PP	08	Safety Shower Water Tank Recirculation Pump		\$ 5,000	1	\$ 4,235											4	
1	800-PP-09	800	PP	09	Safety Shower Pump (Duty)		\$ 3,000	1	\$ 2,503											4	
1	800-PP-10	800	PP	10	Safety Shower Pump (Standby)		\$ 3,000	1	\$ 2,503											4	
1	800-PP-11	800	PP	11	Fast Fill Bowser - Light Vehicle Pump		\$ 7,000	1	\$ 6,545											4	
1	800-PP-12	800	PP	12	Fast Fill Bowser - Mobile Equipment Plant Pump		\$ 7,000	1	\$ 6,930											4	
1	800-PP-13	800	PP	13	Diesel Distribution Pump (Duty)		\$ 2,000	1	\$ 1,388											4	
1	800-PP-14	800	PP	14	Diesel Distribution Pump (Standby)		\$ 2,000	1	\$ 1,388											4	
1	800-PP-15	800	PP	15	Cooling Water Pump (Duty)		\$ 5,000	1	\$ 4,235											4	
1	800-PP-16	800	PP	16	Cooling Water Pump (Standby)		\$ 5,000	1	\$ 4,235											4	
1	800-PP-17	800	PP	17	Cooling Water Distribution Pump (Duty)		\$ 5,000	1	\$ 4,235											4	
1	800-PP-18	800	PP	18	Cooling Water Distribution Pump (Standby)		\$ 5,000	1	\$ 4,235											4	
1	800-PP-19	800	PP	19	Heating Water Pump (Duty)		\$ 5,000	1	\$ 4,235											4	
1	800-PP-20	800	PP	20	Heating Water Pump (Standby)		\$ 5,000	1	\$ 4,235											4	
1	800-RA-01	800	RA	01	Air Receiver		\$ 18,000	0	\$ 17,715	S&L Engineering										4	
1	800-RA-02	800	RA	02	Instrument Air Receiver		\$ 18,000	0	\$ 17,715	S&L Engineering										4	
1	800-TK-01	800	TK	01	Plant Potable Water Tank		\$ 37,000	0	\$ 36,960											4	
1	800-TK-02	800	TK	02	Plant Potable Water Tank-Mining Area		\$ 37,000	0	\$ 36,960											4	
1	800-TK-03	800	TK	03	Safety Shower Water Tank-Mining Area		\$ 37,000	0	\$ 36,960											4	
1	800-TK-04	800	TK	04	Safety Shower Water Tank		\$ 37,000	0	\$ 36,960											4	
1	800-TK-05	800	TK	05	Diesel Storage Tank		\$ 501,000	0	\$ 501,500											4	
1	800-TK-06	800	TK	06	Cooling Water Recycle Tank		\$ 37,000	0	\$ 36,960											4	
1	800-TK-07	800	TK	07	Cooling Water Storage Tank		\$ 37,000	0	\$ 36,960											4	
1	800-TK-08	800	TK	08	Heating Water Recycle Tank		\$ 37,000	0	\$ 36,960											4	
1	0-ME-01	0	ME	01	Workshop Forklift		\$ 35,000	0	\$ 35,000										\$ 17,250	6	
1	0-ME-02	0	ME	02	Stores Forklift		\$ 35,000	0	\$ 35,000										\$ 17,250	6	
1	0-ME-03	0	ME	03	General/Maintenance Light Vehicles		\$ 35,000	0	\$ 35,000										\$ 14,250	6	
1	0-ME-04	0	ME	04	General/Maintenance Light Vehicles		\$ 35,000	0	\$ 35,000										\$ 14,250	6	
1	0-ME-05	0	ME	05	General/Maintenance Light Vehicles		\$ 35,000	0	\$ 35,000										\$ 14,250	6	
1	0-ME-06	0	ME	06	General/Maintenance Light Vehicles		\$ 35,000	0	\$ 35,000										\$ 14,250	6	
1	0-ME-07	0	ME	07	Mobile Lighting Tower		\$ 21,000	0	\$ 20,495										\$ 15,000	6	
1	0-ME-08	0	ME	08	Mobile Lighting Tower		\$ 21,000	0	\$ 20,495										\$ 15,000	6	
1	0-ME-09	0	ME	09	Mobile Lighting Tower		\$ 21,000	0	\$ 20,495										\$ 15,000	6	
1	0-ME-10	0	ME	10	Ambulance		\$ 90,000	0	\$ 80,000										\$ 29,250	6	
1	0-ME-11	0	ME	11	Cherry Picker		\$ 116,000	0	\$ 115,500										\$ 87,000	6	
1	0-ME-12	0	ME	12	Hoist		\$ 15,000	0	\$ 15,000										\$ 6,000	6	
1	0-SHD-01	0	SHD	01	Office/Canteen	16x25x4 (w x l x h)	\$ 80,000	0	\$ 80,000											6	
1	0-SHD-02	0	SHD	02	Security Gate House	12x33x4 (w x l x h)	\$ 80,000	0	\$ 80,000											6	
1	0-SHD-03	0	SHD	03	Assay Laboratory	8x8x4 (w x l x h)	\$ 56,000	0	\$ 56,000											6	
1	0-SHD-04	0	SHD	04	Metallurgical Laboratory	12x33x4 (w x l x h)	\$ 80,000	0	\$ 80,000											6	
1	0-SHD-05	0	SHD	05	Stores	12x32x6 (w x l x h)	\$ 80,000	0	\$ 80,000											6	
1	0-SHD-06	0	SHD	06	Workshop	12x32x6 (w x l x h)	\$ 80,000	0	\$ 80,000											6	
1	0-SHD-07	0	SHD	07	Control Room	8x8x4 (w x l x h)	\$ 56,000	0	\$ 56,000											6	
1	0-SHD-08	0	SHD	08	Admin Office	8x8x4 (w x l x h)	\$ 56,000	0	\$ 56,000											6	
1	0-SHD-09	0	SHD	09	Medical Centre	8x8x4 (w x l x h)	\$ 56,000	0	\$ 56,000											6	
1	0-YTD-01	0	YTD	01	Security Vehicle (4WD)		\$ 54,000	0	\$ 53,960											\$ 40,500	6
1	0-YTD-02	0	YTD	02	Security Vehicle (4WD)		\$ 54,000	0	\$ 53,960											\$ 40,500	6
1	0-YTR-01	0	YTR	01	Water Truck		\$ 193,000	0	\$ 192,500											\$ 144,750	6

Client  
Deep South Resources  
Project  
Halb Leach Project - 8.5 Mtpa @ 85% Cu Recovery  
Document Number  
J5459-CAL-000-001

Quantity	Equipment Number	Area Number	Equipment	Tag	Description	Model/Type (Equivalent or similar)	Equipment Price (USD)	Estimated Power (kW)	Scaled Cost (USD)	Supplier	Scaled Capacity	Units	Scaled Power (kW)	Diversity	Diversified Power (kW)	Basis Capacity	Units	Basis Power (kW)	Basis Cost (USD)	Reference	
1	100-BN-01	100	BN	01	ROM Bin		\$ 118,000		\$ 117,880	Local Fabrication	149	m <sup>3</sup>				236	m <sup>3</sup>		\$ 151,623	2	
2	100-BN-02-03	100	BN	02-03	Cone Crusher Feed Bin		\$ 420,000		\$ 209,628	Local Fabrication	388	m <sup>3</sup>				74	m <sup>3</sup>		\$ 77,596	2	
1	100-CR-01	100	CR	01	Gyratory Crusher	CG510i	\$ 2,065,000	315	\$ 2,064,560	Sandvik	1386	th	315	0.66	208						6
2	100-CR-02-03	100	CR	02-03	Cone Crusher	CH870i-03	\$ 2,095,000	1200	\$ 1,046,139	Sandvik	1396	th	600	0.84	1013						6
1	100-CV-01	100	CV	01	Primary Crusher Discharge Conveyor	1200mm x 150 m x 25 m	\$ 330,000	250	\$ 330,000	Sarwest	2792	th	250	0.85	213	1	m		\$ 2,200	2	
2	100-CV-02-03	100	CV	02-03	Cone Crusher Feed Conveyor	1200 mm x 15 m	\$ 54,000	22	\$ 27,000	Sarwest	1396	th	11	0.85	19	1	m		\$ 1,800	2	
1	100-CV-04	100	CV	04	Cone Crusher Discharge Conveyor	1200mm x 100 m x 25 m	\$ 220,000	250	\$ 220,000	Sarwest	2792	th	250	0.85	213	1	m		\$ 2,200	2	
1	100-CV-05	100	CV	05	Screen US Discharge Conveyor	1200mm x 75 m x 10 m	\$ 165,000	160	\$ 165,000	Sarwest	1663	th	160	0.85	136	1	m		\$ 2,200	2	
2	100-CV-06-07	100	CV	06-07	Crushed Ore Discharge Conveyor	1200 mm x 20 m	\$ 72,000	22	\$ 36,000	Sarwest	832	th	11	0.85	19	1	m		\$ 1,800	2	
1	100-CV-08	100	CV	08	Crushed Product Conveyor	1200 mm x 4500 m x 30 m	\$ 7,650,000	1650	\$ 7,650,000	Sarwest	1663	th	1650	0.85	1403						2
1	100-FE-01	100	FE	01	Primary Crusher Discharge Apron Feeder	Apron Feeder - 1219mm x 6000mm	\$ 319,000	164	\$ 318,319	Sarwest	1663	th	164	0.85	140	450	th	75	\$ 145,275	2	
2	100-FE-02-03	100	FE	02-03	Cone Crusher Vibrating Feeder		\$ 213,000	85	\$ 106,495	Sarwest	1396	th	43	0.75	64	780	th	30	\$ 75,040	2	
2	100-FE-04-05	100	FE	04-05	Cone Crusher Stockpile Discharge Apron Feeder	Apron Feeder - 1219mm x 6000mm	\$ 421,000	217	\$ 210,512	Sarwest	832	th	108	0.85	184	450	th	75	\$ 145,275	2	
3	100-MD-01-03	100	MD	01-03	Metal Detector		\$ 69,000	0	\$ 23,000												4
1	100-MG-01	100	MG	01	Tramp Metal Magnet		\$ 50,000	0	\$ 50,000												4
1	100-RB-01	100	RB	01	Mobile Rock Breaker		\$ 88,000	0	\$ 87,150												4
1	100-SC-01	100	SC	01	Crusher Product Screen	Metso T86.2 Double-Deck Banana	\$ 590,000	66	\$ 589,825	Metso	25	m <sup>2</sup>	66	0.85	56	26	m <sup>2</sup>		\$ 600,000	2	
1	100-SH-01	100	SH	01	Primary Crusher Area Safety Shower and Eyewash Station		\$ 4,000	0	\$ 4,000												4
1	100-SH-02	100	SH	02	Screening Area Safety Shower and Eyewash Station		\$ 4,000	0	\$ 4,000												4
1	100-SH-03	100	SH	03	Cone Crusher Safety Shower and Eyewash Station		\$ 4,000	0	\$ 4,000												4
1	100-SV-01	100	SV	01	Surge Vault		\$ 158,000	0	\$ 157,542	Local Fabrication	257	m <sup>3</sup>				300	m <sup>3</sup>		\$ 173,000	2	
1	100-WS-01-04	100	WS	01-04	Water Sprayer		\$ 50,000	0	\$ 50,000												4
7	100-WT-01-07	100	WT	01-07	Weightometer		\$ 228,000	0	\$ 32,500												4
1	100-SHD-01	100	SHD	01	Crusher Control Room		\$ 25,000	0	\$ 24,293												4
1	100-YFL-01	100	YFL	01	Front End Loader		\$ 520,000	0	\$ 500,000												4
1	100-SP-01	100	SP	01	Crushed Product Stockpile		\$ 1,000,000	0	\$ 1,000,000		19961	t									4
1	200-SP-01	200	SP	01	HPGR Feed Stockpile		\$ 1,600,000	0	\$ 1,600,000		62100	t									4
2	200-BN-01-02	200	BN	01-02	HPGR Feed Bin		\$ 161,000		\$ 80,099	Local Fabrication	78	m <sup>3</sup>				74	m <sup>3</sup>		\$ 77,596	2	
2	200-BN-03-04	200	BN	03-04	Screen Feed Bin		\$ 161,000		\$ 80,099	Local Fabrication	78	m <sup>3</sup>				74	m <sup>3</sup>		\$ 77,596	2	
2	200-CV-01-02	200	CV	01-02	Stockpile Discharge Conveyor	1200 mm x 20 m	\$ 72,000	22	\$ 36,000	Sarwest	647	th	11	0.85	19	1	m		\$ 1,800	2	
1	200-CV-03	200	CV	03	HPGR Feed Conveyor	1200mm x 150 m x 25 m	\$ 330,000	160	\$ 330,000	Sarwest	1662	th	160	0.85	136	1	m		\$ 2,200	2	
2	200-CV-04-05	200	CV	04-05	HPGR Feeders	1200 mm x 15 m	\$ 54,000	22	\$ 27,000	Sarwest	841	th	11	0.85	19	1	m		\$ 1,800	2	
1	200-CV-06	200	CV	06	Screen Feed Conveyor	1200mm x 100 m x 25 m	\$ 180,000	160	\$ 180,000	Sarwest	1662	th	160	0.85	136	1	m		\$ 1,800	2	
1	200-CV-07	200	CV	07	Screen Discharge Conveyor	1200 mm x 75 m x 10 m	\$ 150,000	74	\$ 150,000	Sarwest	1294	th	74	0.85	63	1	m		\$ 2,000	2	
2	200-FE-01-02	200	FE	01-02	HPGR Stockpile Apron Feeder		\$ 362,000	187	\$ 180,617	Sarwest	647	th	93	0.85	159	450	th	75	\$ 145,275	2	
2	200-FE-03-04	200	FE	03-04	HPGR Vibrating Feeder		\$ 158,000	63	\$ 78,555	Sarwest	841	th	31	0.85	53	780	th	30	\$ 75,040	2	
2	200-FE-05-06	200	FE	05-06	Screen Vibrating Feeder		\$ 158,000	63	\$ 78,555	Sarwest	841	th	31	0.85	53	780	th	30	\$ 75,040	2	
2	200-CR-01-02	200	CR	01-02	HPGR	HPGR 63017.6-OWH-1230-PG1E	\$ 7,620,000	5200	\$ 3,812,714	Koepfer	841	th	2600	0.75	3925						2
2	200-MD-01-02	200	MD	01-02	Metal Detector		\$ 46,000	0	\$ 23,000												4
2	200-SC-01	200	SC	01	HPGR Screens	Metso T86.2 Double-Deck Banana	\$ 1,180,000	132	\$ 589,825	Metso	25	m <sup>2</sup>	66	0.75	99	26	m <sup>2</sup>		\$ 600,000	2	
1	200-SH-01	200	SH	01	Grinding Area Safety Shower and Eyewash Station		\$ 4,000	0	\$ 4,000												4
1	200-SH-02	200	SH	02	Screen Area Safety Shower and Eyewash Station		\$ 4,000	0	\$ 4,000												4
1	200-WS-01-03	200	WS	01-03	Water Sprays		\$ 50,000	0	\$ 50,000												4
6	200-WT-01-06	200	WT	01-06	Weightometer		\$ 195,000	0	\$ 32,500												4
1	200-YFL-01	200	YFL	01	Front End Loader		\$ 500,000	0	\$ 500,000												6
2	300-AD-01-02	300	AD	01-02	Agglomeration Drum	3610	\$ 2,700,000	480	\$ 1,350,000	Sepro Systems	170	m <sup>3</sup>	240	0.75	360						2
1	300-BN-01	300	BN	01	Agglomerator Feed Bin		\$ 119,000		\$ 118,442	Local Fabrication	150	m <sup>3</sup>				74	m <sup>3</sup>		\$ 77,596	2	
1	300-CH-01	300	CH	01	Filter Press Discharge Chute	Constructed On Site	\$ 5,000	0	\$ 4,500	Local Fabrication											4
1	300-CV-01	300	CV	01	Agglomerator Feed Conveyor	1200 mm x 75 m x 25 m	\$ 165,000	160	\$ 165,000	Krupp	1294	th	80	0.85	68	1	m		\$ 2,200	2	
1	300-CV-02	300	CV	02	Agglomerator Product Conveyor	1200 mm x 150 m x 50 m	\$ 330,000	160	\$ 330,000	Krupp	1426	th	160	0.85	136	1	m		\$ 2,200	2	
10	300-CV-0X	300	CV	0X	Grashopper Conveyors	1200 mm x 50 m x 2.5 m	\$ 100,000	200	\$ 100,000	Sarwest	1426	th	20	0.85	170	1	m		\$ 2,000	2	
1	300-CV-03	300	CV	03	Radial Stacker for Primary Leach Heap	Rail Mounted Radial Stacker, 1200 mm x 50 m x 15 m	\$ 531,000	84	\$ 530,705	Krupp	1426	th	84	0.85	71	1750	th		\$ 600,000	2	
1	300-CV-04	300	CV	04	Neutralised Tailings Transfer Conveyor	600 mm x 20 m x 5 m	\$ 38,000	21	\$ 38,000	Sarwest	4	th	21	0.85	18	1	m		\$ 1,800	2	
1	300-FE-01	300	FE	01	Belt Feeder	Belt Feeder	\$ 233,000	23	\$ 232,374	Metso	1294	th	23	0.85	20	320	th	10	\$ 100,500	2	
1	300-IR-01	300	IR	01	Primary Heap Leach Drip Irrigation		\$ 117,000	0	\$ 117,000		120000	m				1	m <sup>3</sup>		\$ 1	2	
1	300-IR-02	300	IR	02	Secondary Heap Leach Drip Irrigation		\$ 117,000	0	\$ 117,000		120000	m				1	th		\$ 1	2	
1	300-IR-03	300	IR	03	Wash Heap Leach Drip Irrigation		\$ 117,000	0	\$ 117,000		120000	m				1	th		\$ 1	2	
1	300-PD-01	300	PD	01	Barren Pond		\$ 1,217,000	0	\$ 1,216,800		46800	m <sup>3</sup>				1	m <sup>3</sup>		\$ 26	3	
1	300-PD-02	300	PD	02	LS Pond		\$ 1,217,000	0	\$ 1,216,800		46800	m <sup>3</sup>				1	m <sup>3</sup>		\$ 26	3	
1	300-PD-03	300	PD	03	Active Solution Pond		\$ 1,217,000	0	\$ 1,216,800		46800	m <sup>3</sup>				1	m <sup>3</sup>		\$ 26	3	
1	300-PP-01	300	PP	01	pH Adjustment Thickeners Feed Pump (Duty)		\$ 58,000	161	\$ 57,667	1949	m <sup>3</sup> /h	161	0.75	121	1400	m <sup>3</sup> /h	132	\$ 47,279	2		
1	300-PP-02	300	PP	02	pH Adjustment Thickeners Feed Pump (Standby)		\$ 58,000	161	\$ 57,667	1949	m <sup>3</sup> /h	161	0.00	0	1400	m <sup>3</sup> /h	132	\$ 47,279	2		
1	300-PP-03	300	PP	03	pH Adjustment Filter Press Feed Pump (Duty)		\$ 58,000	161	\$ 57,667	1949	m <sup>3</sup> /h	161	0.75	121	1400	m <sup>3</sup> /h	132	\$ 47,279	2		
1	300-PP-04	300	PP	04	pH Adjustment Filter Press Feed Pump (Standby)		\$ 58,000	161	\$ 57,667	1949	m <sup>3</sup> /h	161	0.00	0	1400	m <sup>3</sup> /h	132	\$ 47,279	2		
1	300-PP-05	300	PP	05	pH Adjustment Filtrate Pump (Duty)		\$ 58,000	161	\$ 57,667	1949	m <sup>3</sup> /h	161	0.75	121	1400	m <sup>3</sup> /h	132	\$ 47,279	2		
1	300-PP-06	300	PP	06	pH Adjustment Filtrate Pump (Standby)		\$ 58,000	161	\$ 57,667	1949	m <sup>3</sup> /h	161	0.00	0	1400	m <sup>3</sup> /h	132	\$ 47,279	2		
1	300-PP-07	300	PP	07	pH Adjustment Thickener Overflow Pump (Duty)	SDB 200/250/Centrifugal	\$ 69,000	191	\$ 68,532	2599	m <sup>3</sup> /h	191	0.75	144	1400	m <sup>3</sup> /h	132	\$ 47,279	2		
1	300-PP-08	300	PP	08	pH Adjustment Thickener Overflow Pump (Standby)	SDB 200/250/Centrifugal	\$ 69,000	191	\$ 68,532	2599	m <sup>3</sup> /h	191	0.00	0	1400	m <sup>3</sup> /h	132	\$ 47,279	2		
1	300-PP-09	300	PP	09	LS Pump (Duty)	SDB 200/250/Centrifugal	\$ 69,000	191	\$ 68,532	2599	m <sup>3</sup> /h	191	0.75	144	1400	m <sup>3</sup> /h	132	\$ 47,279	2		
1	300-PP-10	300	PP	10	Primary Leach Pad Pump (Duty)	SDB 200/250/Centrifugal	\$ 58,000	161	\$ 57,667	1949	m <sup>3</sup> /h	161	0.75	121	1400	m <sup>3</sup> /h	132	\$ 47,279			

Quantity	Equipment Number	Area Number	Equipment	Tag	Description	Model/Type (equivalent or similar)	Equipment Price (USD)	Estimated Power (kW)	Scaled Cost USD	Supplier	Scaled Capacity	Units	Scaled Power (kW)	Diversity	Diversified Power (kW)	Basis Capacity	Units	Basis Power (kW)	Basis Cost (USD)	Reference
1	300-AG-01	300	AG	01	pH Adjustment Tank Agitator	5 m dia x 10 m	\$ 34,000	19	\$ 33,324	Lighthin	164	m <sup>2</sup>	19	0.85	16	354	m <sup>2</sup>	30	\$ 52,799	2
1	300-TH-01	300	TH	01	pH Adjustment Thickener		\$ 232,000	0	\$ 231,611	Waterlec	6	m				20	m		\$ 499,800	2
1	300-FL-01	300	FL	01	pH Adjustment Filter Press		\$ 43,000	10	\$ 42,413		3	lhr	10	0.85	8	50	lhr	50	\$ 214,286	2
1	400-AG-01	400	AG	01	pH Adjustment Tank Agitator	5 m dia x 10 m	\$ 34,000	19	\$ 33,324	Lighthin	164	m <sup>2</sup>	19	0.85	16	354	m <sup>2</sup>	30	\$ 52,799	2
1	400-AG-02	400	AG	02	Organic Control Tank Agitator	5 m dia x 10 m	\$ 34,000	19	\$ 33,324	Lighthin	164	m <sup>2</sup>	19	0.85	16	354	m <sup>2</sup>	30	\$ 52,799	2
1	400-AG-03	400	AG	03	Copper Extraction Mixer Settler Agitator	4.2 m dia x 8.4 m	\$ 25,000	14	\$ 24,489	Lighthin	98	m <sup>2</sup>	14	0.85	12	354	m <sup>2</sup>	30	\$ 52,799	2
1	400-AG-04	400	AG	04	Copper Extraction Mixer Settler Agitator	4.2 m dia x 8.4 m	\$ 25,000	14	\$ 24,489	Lighthin	98	m <sup>2</sup>	14	0.85	12	354	m <sup>2</sup>	30	\$ 52,799	2
1	400-AG-05	400	AG	05	Striping Liqour Tank Agitator	2m dia x 4 m	\$ 3,000	1	\$ 2,470	Lighthin	11	m <sup>2</sup>	1	0.85	1	33	m <sup>2</sup>	2.2	\$ 4,829	2
1	400-AG-06	400	AG	06	Striping Solution Tank Agitator	5 m dia x 10 m	\$ 34,000	19	\$ 33,324	Lighthin	164	m <sup>2</sup>	19	0.85	16	354	m <sup>2</sup>	30	\$ 52,799	2
1	400-AG-07	400	AG	07	Copper Striping Mixer Settler Agitator	3.4 m dia x 6.8 m	\$ 17,000	10	\$ 16,721	Lighthin	52	m <sup>2</sup>	10	0.85	8	354	m <sup>2</sup>	30	\$ 52,799	2
1	400-AG-08	400	AG	08	Copper Striping Mixer Settler Agitator	3.4 m dia x 6.8 m	\$ 17,000	10	\$ 16,721	Lighthin	52	m <sup>2</sup>	10	0.85	8	354	m <sup>2</sup>	30	\$ 52,799	2
1	400-AG-09	400	AG	09	Scrubbing Mixer Settler Agitator	3.4 m dia x 6.8 m	\$ 9,000	8	\$ 8,455	Lighthin	52	m <sup>2</sup>	8	0.85	7	86	m <sup>2</sup>	11	\$ 11,423	2
1	400-AG-11	400	AG	11	Crud Treatment Tank Agitator	2.8 m dia x 5.6 m	\$ 7,000	6	\$ 6,072	Lighthin	30	m <sup>2</sup>	6	0.85	5	86	m <sup>2</sup>	11	\$ 11,423	2
1	400-AG-11	400	AG	11	Crud Treatment Tank Agitator	2.8 m dia x 5.6 m	\$ 7,000	6	\$ 6,072	Lighthin	30	m <sup>2</sup>	6	0.85	5	86	m <sup>2</sup>	11	\$ 11,423	2
1	400-CF-01	400	CF	01	Crud Centrifuge	Scroll Centrifuge	\$ 249,000	18	\$ 248,817		3	lhr	18	0.85	16	8	lhr	37	\$ 500,000	2
1	400-CH-01	400	CH	01	Filter Press Discharge Chute	Constructed On Site	\$ 5,000	0	\$ 4,500	Local fabrication										4
1	400-CV-01	400	CV	01	Neutralised Tailings Transfer Conveyor	600 mm x 200 m x 10 m	\$ 360,000	21	\$ 360,000	Sarwest	4	lhr	21	0.85	18	1	m		\$ 1,800	2
1	400-CV-02	400	CV	02	Stripped Sheet Conveyor	600 mm x 20 m	\$ 36,000	11	\$ 36,000	Sarwest	2	lhr	11	0.85	9	1	m		\$ 1,800	2
1	400-CV-03	400	CV	03	Cathode Discharge Conveyor	600 mm x 20 m	\$ 36,000	11	\$ 36,000	Sarwest	3	lhr	11	0.85	9	1	m		\$ 1,800	2
104	400-EC-01-104	400	EC	01-104	Electrowinning Cell		\$ 6,965,000	6195	\$ 6,964,709		21480		100	6195	11000	tpa			\$ 6,000,000	4
2	400-FL-01-02	400	FL	01-02	pH Adjustment Filter Press	Pressure Filter Demme Me1500 2800 MB	\$ 85,000	20	\$ 82,413		3	lhr	10	0.85	17	70	lhr	50	\$ 214,286	2
3	400-FL-03-05	400	FL	03-05	Polishing Filter		\$ 920,000	142	\$ 908,964		656	m <sup>3</sup>	47	0.85	121	50	m <sup>3</sup>	50	\$ 324,000	2
1	400-HE-01	400	HE	01	Heater and Cooling System	SX Feed Intercooler-MBMFG	\$ 8,000	0	\$ 7,500	Alfa Laval									4	
1	400-HE-02	400	HE	02	Heater and Cooling System	SX Feed Intercooler-MBMFG	\$ 8,000	0	\$ 7,500	Alfa Laval									4	
1	400-HE-03	400	HE	03	Heater and Cooling System	SX Feed Intercooler-MBMFG	\$ 8,000	0	\$ 7,500	Alfa Laval									4	
1	400-HE-04	400	HE	04	Heater and Cooling System	SX Feed Intercooler-MBMFG	\$ 8,000	0	\$ 7,500	Alfa Laval									4	
1	400-HE-05	400	HE	05	Heater and Cooling System	SX Feed Intercooler-MBMFG	\$ 8,000	0	\$ 7,500	Alfa Laval									4	
1	400-HE-06	400	HE	06	Heater and Cooling System	SX Feed Intercooler-MBMFG	\$ 8,000	0	\$ 7,500	Alfa Laval									4	
1	400-HE-07	400	HE	07	Heater and Cooling System	SX Feed Intercooler-MBMFG	\$ 8,000	0	\$ 7,500	Alfa Laval									4	
1	400-HE-08	400	HE	08	Heater and Cooling System	SX Feed Intercooler-MBMFG	\$ 8,000	0	\$ 7,500	Alfa Laval									4	
1	400-HE-09	400	HE	09	Heater and Cooling System	SX Feed Intercooler-MBMFG	\$ 8,000	0	\$ 7,500	Alfa Laval									4	
1	400-HE-10	400	HE	10	Heater and Cooling System	SX Feed Intercooler-MBMFG	\$ 8,000	0	\$ 7,500	Alfa Laval									4	
1	400-HE-01	400	HE	01	Crane		\$ 150,000	0	\$ 150,000											6
1	400-PP-01	400	PP	01	pH Adjustment Tank Pump (Duty)	MC 200-355	\$ 81,000	143	\$ 80,972	Weir	1971	m <sup>3</sup>	143	0.75	107	402	m <sup>3</sup>	55	\$ 31,170	2
1	400-PP-02	400	PP	02	pH Adjustment Tank Pump (Standby)	MC 200-355	\$ 81,000	143	\$ 80,972	Weir	1971	m <sup>3</sup>	143	0.00	0	402	m <sup>3</sup>	55	\$ 31,170	2
1	400-PP-03	400	PP	03	Thickener Underflow Pump (Duty)	MC 200-355	\$ 3,000	4	\$ 2,122	Weir	5	m <sup>3</sup>	4	0.75	3	402	m <sup>3</sup>	55	\$ 31,170	2
1	400-PP-04	400	PP	04	Thickener Underflow Pump (Standby)	MC 200-355	\$ 3,000	4	\$ 2,122	Weir	5	m <sup>3</sup>	4	0.00	0	402	m <sup>3</sup>	55	\$ 31,170	2
1	400-PP-05	400	PP	05	Filtrate Recycling Pump (Duty)	MC 200-355	\$ 2,000	3	\$ 1,766	Weir	3	m <sup>3</sup>	3	0.75	2	402	m <sup>3</sup>	55	\$ 31,170	2
1	400-PP-06	400	PP	06	Filtrate Recycling Pump (Standby)	MC 200-355	\$ 2,000	3	\$ 1,766	Weir	3	m <sup>3</sup>	3	0.00	0	402	m <sup>3</sup>	55	\$ 31,170	2
1	400-PP-07	400	PP	07	Polishing Filter Pump (Duty)	MC 200-355	\$ 81,000	143	\$ 80,829	Weir	1968	m <sup>3</sup>	143	0.75	107	402	m <sup>3</sup>	55	\$ 31,170	2
1	400-PP-08	400	PP	08	Polishing Filter Pump (Standby)	MC 200-355	\$ 81,000	143	\$ 80,829	Weir	1968	m <sup>3</sup>	143	0.00	0	402	m <sup>3</sup>	55	\$ 31,170	2
1	400-PP-09	400	PP	09	Copper SX PLS Feed Pump (Duty)	MC 200-355	\$ 81,000	143	\$ 80,829	Weir	1968	m <sup>3</sup>	143	0.75	107	402	m <sup>3</sup>	55	\$ 31,170	2
1	400-PP-10	400	PP	10	Copper SX PLS Feed Pump (Standby)	MC 200-355	\$ 81,000	143	\$ 80,829	Weir	1968	m <sup>3</sup>	143	0.00	0	402	m <sup>3</sup>	55	\$ 31,170	2
1	400-PP-11	400	PP	11	Organic Transfer Pump (Duty)	MC 200-355	\$ 81,000	143	\$ 80,829	Weir	1968	m <sup>3</sup>	143	0.75	107	402	m <sup>3</sup>	55	\$ 31,170	2
1	400-PP-12	400	PP	12	Organic Transfer Pump (Standby)	MC 200-355	\$ 81,000	143	\$ 80,829	Weir	1968	m <sup>3</sup>	143	0.00	0	402	m <sup>3</sup>	55	\$ 31,170	2
1	400-PP-13	400	PP	13	Copper Extraction Crud Transfer Pump (Duty)	Peristaltic Pump	\$ 6,000	1	\$ 5,404	Flowrex	1	m <sup>3</sup>	1	0.75	1	0.53	m <sup>3</sup>	0.75	\$ 3,692	2
1	400-PP-14	400	PP	14	Copper Extraction Crud Transfer Pump (Standby)	Peristaltic Pump	\$ 6,000	1	\$ 5,404	Flowrex	1	m <sup>3</sup>	1	0.00	0	0.53	m <sup>3</sup>	0.75	\$ 3,692	2
1	400-PP-15	400	PP	15	Raffinate Pump (Duty)	MC 200-355	\$ 81,000	143	\$ 80,829	Weir	1968	m <sup>3</sup>	143	0.75	107	402	m <sup>3</sup>	55	\$ 31,170	2
1	400-PP-16	400	PP	16	Raffinate Pump (Standby)	MC 200-355	\$ 81,000	143	\$ 80,829	Weir	1968	m <sup>3</sup>	143	0.00	0	402	m <sup>3</sup>	55	\$ 31,170	2
1	400-PP-17	400	PP	17	Loaded Organic Pump (Duty)	MC 200-355	\$ 81,000	78	\$ 80,829	Weir	1968	m <sup>3</sup>	78	0.75	58	402	m <sup>3</sup>	30	\$ 31,170	2
1	400-PP-18	400	PP	18	Loaded Organic Pump (Standby)	MC 200-355	\$ 81,000	78	\$ 80,829	Weir	1968	m <sup>3</sup>	78	0.00	0	402	m <sup>3</sup>	30	\$ 31,170	2
1	400-PP-19	400	PP	19	Copper Extraction Crud Transfer Pump (Duty)	Peristaltic Pump	\$ 6,000	1	\$ 5,404	Flowrex	1	m <sup>3</sup>	1	0.75	1	0.53	m <sup>3</sup>	0.75	\$ 3,692	2
1	400-PP-20	400	PP	20	Copper Extraction Crud Transfer Pump (Standby)	Peristaltic Pump	\$ 6,000	1	\$ 5,404	Flowrex	1	m <sup>3</sup>	1	0.00	0	0.53	m <sup>3</sup>	0.75	\$ 3,692	2
1	400-PP-21	400	PP	21	Raffinate Pump (Duty)	GEKONORM NM 32-160	\$ 29,000	19	\$ 28,732	Weir	1968	m <sup>3</sup>	19	0.75	15	402	m <sup>3</sup>	7.5	\$ 11,080	2
1	400-PP-22	400	PP	22	Raffinate Pump (Standby)	GEKONORM NM 32-160	\$ 29,000	19	\$ 28,732	Weir	1968	m <sup>3</sup>	19	0.00	0	402	m <sup>3</sup>	7.5	\$ 11,080	2
1	400-PP-23	400	PP	23	Loaded Organic Pump (Duty)	MC 200-355	\$ 81,000	78	\$ 80,829	Weir	1968	m <sup>3</sup>	78	0.75	58	402	m <sup>3</sup>	30	\$ 31,170	2
1	400-PP-24	400	PP	24	Loaded Organic Pump (Standby)	MC 200-355	\$ 81,000	78	\$ 80,829	Weir	1968	m <sup>3</sup>	78	0.00	0	402	m <sup>3</sup>	30	\$ 31,170	2
1	400-PP-25	400	PP	25	Striping Feed Pump (Duty)	MC 200-355	\$ 81,000	143	\$ 80,829	Weir	1968	m <sup>3</sup>	143	0.75	107	402	m <sup>3</sup>	55	\$ 31,170	2
1	400-PP-26	400	PP	26	Striping Feed Pump (Standby)	MC 200-355	\$ 81,000	143	\$ 80,829	Weir	1968	m <sup>3</sup>	143	0.00	0	402	m <sup>3</sup>	55	\$ 31,170	2
1	400-PP-27	400	PP	27	Striping Liqour Pump (Duty)	GEKONORM NM 32-160	\$ 6,000	4	\$ 5,255	Weir	116	m <sup>3</sup>	4							

Quantity	Equipment Number	Area Number	Equipment	Tag	Description	Model/Type (equivalent or similar)	Equipment Price (USD)	Estimated Power (kW)	Scaled Cost USD	Supplier	Scaled Capacity	Units	Scaled Power (kW)	Diversity	Diversified Power (kW)	Basis Capacity	Units	Basis Power (kW)	Basis Cost (USD)	Reference	
1	400-PP-56	400	PP	56	Electrowinning Discharge Pump (Standby)		\$ 9,000	1	\$ 8,769	Weir	116	m <sup>3</sup> /h	1	0.00	0	75	m <sup>3</sup> /h	1.1	\$ 6,752	2	
1	400-PP-57	400	PP	57	Cathode Washing Tank Discharge Pump (Duty)		\$ 3,000	0	\$ 2,868	Weir	18	m <sup>3</sup> /h	0.5	0.75	0	75	m <sup>3</sup> /h	1.1	\$ 6,752	2	
1	400-PP-58	400	PP	58	Cathode Washing Tank Discharge Pump (Standby)		\$ 3,000	0	\$ 2,868	Weir	18	m <sup>3</sup> /h	0.5	0.00	0	75	m <sup>3</sup> /h	1.1	\$ 6,752	2	
1	400-PP-59	400	PP	59	Stripping Liquor Return Pump (Duty)		\$ 9,000	1	\$ 8,769	Weir	116	m <sup>3</sup> /h	1.4	0.75	1	75	m <sup>3</sup> /h	1.1	\$ 6,752	2	
1	400-PP-60	400	PP	60	Stripping Liquor Return Pump (Standby)		\$ 9,000	1	\$ 8,769	Weir	116	m <sup>3</sup> /h	1.4	0.00	0	75	m <sup>3</sup> /h	1.1	\$ 6,752	2	
1	400-PS-01	400	PS	01	Copper EX Mixer Settle Pump		\$ 12,000	0	\$ 11,106											4	
1	400-PS-02	400	PS	02	Copper Stripping Mixer Settle Pump		\$ 12,000	0	\$ 11,106											4	
1	400-PS-03	400	PS	03	Scrubbing Sump Pump		\$ 12,000	0	\$ 11,106											4	
1	400-PS-04	400	PS	04	Electrowinning Sump Pump		\$ 12,000	0	\$ 11,106											4	
13	400-SH-01-13	400	SH	01-13	Safety Shower and Eyewash Station		\$ 13,000	0	\$ 1,000											4	
1	400-SX-01	400	SX	01	Scrubbing Mixer Settler	settler, DOP tank, Mixer tank	\$ 796,000	32	\$ 735,740	Outotec	492	m <sup>3</sup> /h	32	0.75	24	442	m <sup>3</sup> /h	30	\$ 690,000	2	
1	400-SX-02	400	SX	02	Copper Extraction Mixer Settler	settler, DOP tank, Mixer tank	\$ 2,853,000	78	\$ 2,852,472	Outotec	3935	m <sup>3</sup> /h	78	0.75	58	804	m <sup>3</sup> /h	30	\$ 1,100,000	2	
1	400-SX-03	400	SX	03	Copper Extraction Mixer Settler	settler, DOP tank, Mixer tank	\$ 2,853,000	78	\$ 2,852,472	Outotec	3935	m <sup>3</sup> /h	78	0.75	58	804	m <sup>3</sup> /h	30	\$ 1,100,000	2	
1	400-SX-04	400	SX	04	Copper Stripping Mixer Settler	settler, DOP tank, Mixer tank	\$ 1,749,359	38	\$ 1,749,359	Outotec	2084	m <sup>3</sup> /h	38	0.75	29	442	m <sup>3</sup> /h	15	\$ 690,000	2	
1	400-SX-05	400	SX	05	Copper Stripping Mixer Settler	settler, DOP tank, Mixer tank	\$ 1,749,359	38	\$ 1,749,359	Outotec	2084	m <sup>3</sup> /h	38	0.75	29	442	m <sup>3</sup> /h	15	\$ 690,000	2	
1	400-TH-01	400	TH	01	pH Adjustment Thickener		\$ 231,000	0	\$ 231,631	Waterex	6	m				20	m		\$ 498,800	2	
1	400-TK-01	400	TK	01	pH Adjustment Tank	GL1304 Steel 6.02m D x 4.27m, 122kL	\$ 143,000	0	\$ 148,862	Pioneer	164	m <sup>3</sup>				390	m <sup>3</sup>		\$ 250,000	2	
1	400-TK-02	400	TK	02	SX PLS Feed Tank	GL1304 Steel 6.02m D x 4.27m, 122kL	\$ 226,000	0	\$ 225,663	Pioneer	329	m <sup>3</sup>				390	m <sup>3</sup>		\$ 250,000	2	
1	400-TK-03	400	TK	03	Organic Control Tank	GL1304 Steel 6.02m D x 4.27m, 122kL	\$ 28,000	0	\$ 27,963	Pioneer	164	m <sup>3</sup>				122	m <sup>3</sup>		\$ 23,381	2	
1	400-TK-04	400	TK	04	Loaded Organic Tank	GL1304 Steel 6.02m D x 4.27m, 122kL	\$ 28,000	0	\$ 27,962	Pioneer	164	m <sup>3</sup>				122	m <sup>3</sup>		\$ 23,381	2	
1	400-TK-05	400	TK	05	Strip Liquor Makeup Tank	GL1304 Steel 6.02m D x 4.27m, 122kL	\$ 14,000	0	\$ 13,158	Pioneer	11	m <sup>3</sup>				50	m <sup>3</sup>		\$ 33,000	2	
1	400-TK-06	400	TK	06	Scrubbing Solution Makeup Tank	GL1304 Steel 6.02m D x 4.27m, 122kL	\$ 149,000	0	\$ 148,862	Pioneer	164	m <sup>3</sup>				390	m <sup>3</sup>		\$ 250,000	2	
1	400-TK-07	400	TK	07	PLS Tank	GL1304 Steel 6.02m D x 4.27m, 122kL	\$ 149,000	0	\$ 148,862	Pioneer	164	m <sup>3</sup>				390	m <sup>3</sup>		\$ 250,000	2	
1	400-TK-08	400	TK	08	SX Waste Tank	GL1304 Steel 6.02m D x 4.27m, 122kL	\$ 3,000	0	\$ 2,829	Pioneer	1	m <sup>3</sup>				50	m <sup>3</sup>		\$ 33,000	2	
1	400-TK-09	400	TK	09	Crud Treatment Tank	GL1304 Steel 6.02m D x 4.27m, 122kL	\$ 3,000	0	\$ 12,964	Pioneer	10	m <sup>3</sup>				50	m <sup>3</sup>		\$ 33,000	2	
1	400-TK-10	400	TK	10	Certrate Collection Tank	GL1304 Steel 6.02m D x 4.27m, 122kL	\$ 13,000	0	\$ 12,964	Pioneer	10	m <sup>3</sup>				50	m <sup>3</sup>		\$ 33,000	2	
1	400-TK-11	400	TK	11	Cathode Washing Tank	GL1304 Steel 6.02m D x 4.27m, 122kL	\$ 117,000	0	\$ 116,798	Pioneer	164	m <sup>3</sup>				20	m <sup>3</sup>		\$ 33,000	2	
1	400-TK-12	400	TK	12	Stripping Liquor Tank	GL1304 Steel 6.02m D x 4.27m, 122kL	\$ 14,000	0	\$ 13,158	Pioneer	11	m <sup>3</sup>				50	m <sup>3</sup>		\$ 33,000	2	
1	400-XM-01	400	XM	01	Cathode Flexing Station		\$ 50,000	0	\$ 50,000											4	
1	400-XM-02	400	XM	02	Cathode Stripping Station		\$ 80,000	0	\$ 80,000												4
1	400-XM-03	400	XM	03	Cathode Washing Station		\$ 50,000	0	\$ 50,000												4
1	400-XM-04	400	XM	04	Cathode Strapping Station		\$ 80,000	0	\$ 80,000												4
1	400-XM-05	400	XM	05	Cathode Punch Station		\$ 50,000	0	\$ 50,000												4
1	400-XM-06	400	XM	06	Cathode Weighing Station		\$ 80,000	0	\$ 80,000												4
1	400-YTR-01	400	YTR	01	Foam/CO2 Free Truck (for SX)		\$ 200,000	0	\$ 200,000												6
1	400-YTR-02	400	YTR	02	Copper Product Flatbed Truck		\$ 120,000	0	\$ 120,000												6
1	500-AG-01	500	AG	01	Precipitation Tank Agitator	5 m dia x 10 m	\$ 30,000	17	\$ 29,212	Mixtec	132	m <sup>3</sup>	17	0.85	14	354	m <sup>3</sup>	30	\$ 52,799	2	
1	500-AG-02	500	AG	02	Iron Tailings Filter Feed Tank Agitator	5 m dia x 10 m	\$ 30,000	17	\$ 29,212	Mixtec	132	m <sup>3</sup>	17	0.85	14	354	m <sup>3</sup>	30	\$ 52,799	2	
2	500-CH-01-02	500	CH	01-02	Filter Press Discharge Chute	Constructed On Site	\$ 9,000	0	\$ 4,500	Local Fabrication											4
1	500-CV-01	500	CV	01	Filter Press Discharge Conveyor	600 mm x 50 m x 10 m	\$ 90,000	22	\$ 90,000	Samwest	92	l/h	22	0.85	19	1	m		\$ 1,800	2	
1	500-CV-02	500	CV	02	Tailings Handling Conveyor	Rail Mounted Radial Stackers, 600 mm x 50 m x 15 m	\$ 108,000	22	\$ 107,744	Krupp	100	l/hr	22	0.85	19	1750	l/hr		\$ 600,000	2	
2	500-FL-01-02	500	FL	01-02	Iron Tailings Filter Press		\$ 371,000	86	\$ 185,032		39	l/hr	43	0.85	73	50	l/hr	50	\$ 214,286	2	
1	500-PP-01	500	PP	01	Precipitation Tank Pump (Duty)	SDB 200/250/Centrifugal	\$ 12,000	32	\$ 11,464	Weir	132	m <sup>3</sup> /h	32	0.75	24	1400	m <sup>3</sup> /h	132	\$ 47,279	2	
1	500-PP-02	500	PP	02	Precipitation Tank Pump (Standby)	SDB 200/250/Centrifugal	\$ 12,000	32	\$ 11,464	Weir	132	m <sup>3</sup> /h	32	0.00	0	1400	m <sup>3</sup> /h	132	\$ 47,279	2	
1	500-PP-03	500	PP	03	Thickener U/P Pump (Duty)	SDB 200/250/Centrifugal	\$ 11,000	28	\$ 10,065	Weir	106	m <sup>3</sup> /h	28	0.75	21	1400	m <sup>3</sup> /h	132	\$ 47,279	2	
1	500-PP-04	500	PP	04	Thickener U/P Pump (Standby)	SDB 200/250/Centrifugal	\$ 11,000	28	\$ 10,065	Weir	106	m <sup>3</sup> /h	28	0.00	0	1400	m <sup>3</sup> /h	132	\$ 47,279	2	
1	500-PP-05	500	PP	05	Baren Solution Pond Feed Pump (Duty)	Warman 3k2AH	\$ 24,000	14	\$ 23,671	Weir	726	m <sup>3</sup> /h	14	0.75	11	150	m <sup>3</sup> /h	5.5	\$ 9,188	2	
1	500-PP-06	500	PP	06	Baren Solution Pond Feed Pump (Standby)	Warman 3k2AH	\$ 24,000	14	\$ 23,671	Weir	726	m <sup>3</sup> /h	14	0.00	0	150	m <sup>3</sup> /h	5.5	\$ 9,188	2	
1	500-PP-07	500	PP	07	Filter Feed Pump (Duty)	Warman 3k2AH	\$ 8,000	4	\$ 7,471	Weir	106	m <sup>3</sup> /h	4	0.75	3	150	m <sup>3</sup> /h	5.5	\$ 9,188	2	
1	500-PP-08	500	PP	08	Filter Feed Pump (Standby)	Warman 3k2AH	\$ 8,000	4	\$ 7,471	Weir	106	m <sup>3</sup> /h	4	0.00	0	150	m <sup>3</sup> /h	5.5	\$ 9,188	2	
1	500-PP-09	500	PP	09	Filtrate Pump (Duty)	Warman 3k2AH	\$ 5,000	3	\$ 4,524	Weir	46	m <sup>3</sup> /h	3	0.75	2	150	m <sup>3</sup> /h	5.5	\$ 9,188	2	
1	500-PP-10	500	PP	10	Filtrate Pump (Standby)	Warman 3k2AH	\$ 5,000	3	\$ 4,524	Weir	46	m <sup>3</sup> /h	3	0.00	0	150	m <sup>3</sup> /h	5.5	\$ 9,188	2	
1	500-PP-11	500	PP	11	Filtrate Pump (Duty)	Warman 3k2AH	\$ 5,000	3	\$ 4,524	Weir	46	m <sup>3</sup> /h	3	0.75	2	150	m <sup>3</sup> /h	5.5	\$ 9,188	2	
1	500-PP-12	500	PP	12	Filtrate Pump (Standby)	Warman 3k2AH	\$ 5,000	3	\$ 4,524	Weir	46	m <sup>3</sup> /h	3	0.00	0	150	m <sup>3</sup> /h	5.5	\$ 9,188	2	
1	500-PS-01	500	PS	01	Thickener Sump Pump		\$ 12,000	0	\$ 11,106											4	
1	500-PS-02	500	PS	02	Filter Press Sump Pump		\$ 12,000	0	\$ 11,106												4
1	500-PS-03	500	PS	03	Filter Press Sump Pump		\$ 12,000	0	\$ 11,106												4
1	500-SH-01	500	SH	01	Safety Shower and Eyewash Station		\$ 4,000	0	\$ 4,000												4
1	500-TK-01	500	TK	01	Thickener		\$ 996,000	0	\$ 995,032	Waterex	27	m				20	m		\$ 499,800	2	
1	500-TK-01	500	TK	01	Precipitation Tank	GL1304 Steel 6.02m D x 4.27m, 122kL	\$ 131,000	0	\$ 130,511	Pioneer	132	m <sup>3</sup>				390	m <sup>3</sup>		\$ 250,000	2	
1	500-TK-02	500	TK	02	Iron Tailings Filter Feed Tank	GL1304 Steel 6.02m D x 4.27m, 122kL	\$ 131,000	0	\$ 130,511	Pioneer	132	m <sup>3</sup>									



Quantity	Equipment Number	Area Number	Equipment	Tag	Description	Model/Type (equivalent or similar)	Equipment Price (USD)	Estimated Power (kW)	Scaled Cost USD	Supplier	Scaled Capacity	Units	Scaled Power (kW)	Diversity	Diversified Power (kW)	Basis Capacity	Units	Basis Power (kW)	Basis Cost (USD)	Reference
1	700-BN-02	700	BN	02	Limestone/Calcrite Feed Silo		\$ 142,000		\$ 141,696	Local Fabrication	38	m <sup>3</sup>				100	m <sup>3</sup>		\$ 251,273	2
1	700-FE-01	700	FE	01	Quicklime Feeder	Belt Feeder	\$ 4,000	2	\$ 3,026	Metsco	0.9	lhr	2			320	lhr	10	\$ 100,500	3
1	700-FE-02	700	FE	02	Limestone/Calcrite Feeder	Belt Feeder	\$ 8,000	1	\$ 7,396	Metsco	4.1	lhr	1	0.75	2	320	lhr	10	\$ 100,500	3
1	700-MH-01	700	MH	01	Bulk Bag Monorail and Hoist		\$ 18,000	0	\$ 18,000	Eibbeck Cranes										2
1	700-ME-01	700	ME	01	Forklift		\$ 30,000	0	\$ 30,000											6
1	700-ME-02	700	ME	02	Crane		\$ 150,000	0	\$ 150,000											6
1	700-ME-03	700	ME	03	Crane		\$ 150,000	0	\$ 150,000											6
1	700-PK-01	700	PK	01	Lime Slaking Mill		\$ 450,000	0	\$ 450,000											4
1	700-PK-02	700	PK	02	Quar Gum Vendor Package		\$ 250,000	0	\$ 250,000											4
1	700-PK-03	700	PK	03	Cobalt Sulphate Vendor Package		\$ 50,000	0	\$ 50,000											4
1	700-PK-04	700	PK	04	Polyacrylamide Vendor Package		\$ 250,000	0	\$ 250,000											4
1	700-PK-05	700	PK	05	Flocculant Vendor Package		\$ 71,000	2	\$ 70,967	Transmin	8.17	kg/hr	2	0.50	1	218	kg/hr	15	\$ 502,785	2
1	700-PP-01	700	PP	01	Lime Transfer Pump (Duty)		\$ 4,000	1	\$ 4,000	Allied Colloids	0.9	m <sup>3</sup> /h	0.1	0.75	0	75	m <sup>3</sup> /h	1.1	\$ 6,752	2
1	700-PP-02	700	PP	02	Lime Transfer Pump (Standby)		\$ 4,000	1	\$ 4,000	Allied Colloids	0.9	m <sup>3</sup> /h	0.1	0.00	0	75	m <sup>3</sup> /h	1.1	\$ 6,752	2
1	700-PP-03	700	PP	03	Lime Metering Pump (Duty)		\$ 4,000	1	\$ 4,000	Allied Colloids	0.9	m <sup>3</sup> /h	0.1	0.75	0	75	m <sup>3</sup> /h	1.1	\$ 6,752	2
1	700-PP-04	700	PP	04	Lime Metering Pump (Standby)		\$ 4,000	1	\$ 4,000	Allied Colloids	0.9	m <sup>3</sup> /h	0.1	0.00	0	75	m <sup>3</sup> /h	1.1	\$ 6,752	2
1	700-PP-05	700	PP	05	Lime Metering Pump (Duty)		\$ 4,000	1	\$ 4,000	Allied Colloids	0.9	m <sup>3</sup> /h	0.08	0.75	0	75	m <sup>3</sup> /h	1.1	\$ 6,752	2
1	700-PP-06	700	PP	06	Lime Metering Pump (Standby)		\$ 4,000	1	\$ 4,000	Allied Colloids	0.9	m <sup>3</sup> /h	0.08	0.00	0	75	m <sup>3</sup> /h	1.1	\$ 6,752	2
1	700-PP-07	700	PP	07	Lime Metering Pump (Duty)		\$ 4,000	1	\$ 4,000	Allied Colloids	0.9	m <sup>3</sup> /h	0.1	0.75	0	75	m <sup>3</sup> /h	1.1	\$ 6,752	2
1	700-PP-08	700	PP	08	Lime Metering Pump (Standby)		\$ 4,000	1	\$ 4,000	Allied Colloids	0.9	m <sup>3</sup> /h	0.1	0.00	0	75	m <sup>3</sup> /h	1.1	\$ 6,752	2
1	700-PP-09	700	PP	09	Limestone Metering Pump (Duty)		\$ 14,000	1	\$ 14,000	Allied Colloids	4.1	m <sup>3</sup> /h	0.2	0.75	0	75	m <sup>3</sup> /h	1.1	\$ 6,752	2
1	700-PP-10	700	PP	10	Limestone Metering Pump (Standby)		\$ 14,000	1	\$ 14,000	Allied Colloids	4.1	m <sup>3</sup> /h	0.2	0.00	0	75	m <sup>3</sup> /h	1.1	\$ 6,752	2
1	700-PP-11	700	PP	11	Limestone Metering Pump (Duty)		\$ 14,000	1	\$ 14,000	Allied Colloids	4.1	m <sup>3</sup> /h	0.20	0.75	0	75	m <sup>3</sup> /h	1.1	\$ 6,752	2
1	700-PP-12	700	PP	12	Limestone Metering Pump (Standby)		\$ 14,000	1	\$ 14,000	Allied Colloids	4.1	m <sup>3</sup> /h	0.20	0.00	0	75	m <sup>3</sup> /h	1.1	\$ 6,752	2
1	700-PP-13	700	PP	13	Limestone Metering Pump (Duty)		\$ 14,000	1	\$ 14,000	Allied Colloids	4.1	m <sup>3</sup> /h	0.2	0.75	0	75	m <sup>3</sup> /h	1.1	\$ 6,752	2
1	700-PP-14	700	PP	14	Limestone Metering Pump (Standby)		\$ 14,000	1	\$ 14,000	Allied Colloids	4.1	m <sup>3</sup> /h	0.2	0.00	0	75	m <sup>3</sup> /h	1.1	\$ 6,752	2
1	700-PP-15	700	PP	15	Acid Metering Pump (Duty)		\$ 18,000	3	\$ 17,827		0.7	m <sup>3</sup> /h	3	0.75	2	0.037	m <sup>3</sup> /h	0.55	\$ 3,111	2
1	700-PP-16	700	PP	16	Acid Metering Pump (Standby)		\$ 18,000	3	\$ 17,827		0.7	m <sup>3</sup> /h	3	0.00	0	0.037	m <sup>3</sup> /h	0.55	\$ 3,111	2
1	700-PP-17	700	PP	17	Acid Metering Pump (Duty)		\$ 18,000	3	\$ 17,827		0.7	m <sup>3</sup> /h	3	0.75	2	0.037	m <sup>3</sup> /h	0.55	\$ 3,111	2
1	700-PP-18	700	PP	18	Acid Metering Pump (Standby)		\$ 18,000	3	\$ 17,827		0.7	m <sup>3</sup> /h	3	0.00	0	0.037	m <sup>3</sup> /h	0.55	\$ 3,111	2
1	700-PP-19	700	PP	19	Acid Metering Pump (Duty)		\$ 18,000	3	\$ 17,827		0.7	m <sup>3</sup> /h	3.16	0.75	2	0.037	m <sup>3</sup> /h	0.55	\$ 3,111	2
1	700-PP-20	700	PP	20	Acid Metering Pump (Standby)		\$ 18,000	3	\$ 17,827		0.7	m <sup>3</sup> /h	3.16	0.00	0	0.037	m <sup>3</sup> /h	0.55	\$ 3,111	2
1	700-PP-21	700	PP	21	Acid Metering Pump (Duty)		\$ 18,000	3	\$ 17,827		0.7	m <sup>3</sup> /h	3	0.75	2	0.037	m <sup>3</sup> /h	0.55	\$ 3,111	2
1	700-PP-22	700	PP	22	Acid Metering Pump (Standby)		\$ 18,000	3	\$ 17,827		0.7	m <sup>3</sup> /h	3	0.00	0	0.037	m <sup>3</sup> /h	0.55	\$ 3,111	2
1	700-PP-23	700	PP	23	LIX Transfer Pump (Duty)		\$ 8,800	1	\$ 8,800	Allied Colloids	30	L	1.0	0.75	1					2
1	700-PP-24	700	PP	24	LIX Transfer Pump (Standby)		\$ 8,800	1	\$ 8,800	Allied Colloids	30	L	1.0	0.00	0					2
1	700-PP-25	700	PP	25	LIX Metering Pump (Duty)		\$ 8,800	1	\$ 8,800	Allied Colloids	30	L	1.0	0.75	1					2
1	700-PP-26	700	PP	26	LIX Metering Pump (Standby)		\$ 8,800	1	\$ 8,800	Allied Colloids	30	L	1.0	0.00	0					2
1	700-PP-27	700	PP	27	Kerosene Metering Pump (Duty)	Mono B021 in 316 S.S.	\$ 13,000	1	\$ 13,000	Challenge	201	L	1.0	0.75	1					2
1	700-PP-28	700	PP	28	Kerosene Metering Pump (Standby)	Mono B021 in 316 S.S.	\$ 13,000	1	\$ 13,000	Challenge	201	L	1.0	0.00	0					2
1	700-PP-29	700	PP	29	Kerosene Metering Pump (Duty)	Mono B021 in 316 S.S.	\$ 13,000	1	\$ 13,000	Challenge	201	L	1.0	0.75	1					2
1	700-PP-30	700	PP	30	Kerosene Metering Pump (Standby)	Mono B021 in 316 S.S.	\$ 13,000	1	\$ 13,000	Challenge	201	L	1.0	0.00	0					2
1	700-PS-01	700	PS	01	Lime Sump Pump		\$ 12,000	0	\$ 11,106											4
1	700-PS-02	700	PS	02	Limestone Sump Pump		\$ 12,000	0	\$ 11,106											4
1	700-PS-03	700	PS	03	Acid Sump Pump		\$ 12,000	0	\$ 11,106											4
1	700-PS-04	700	PS	04	LIX Sump Pump		\$ 12,000	0	\$ 11,106											4
1	700-PS-05	700	PS	05	Quar Gum Sump Pump		\$ 12,000	0	\$ 11,106											4
1	700-PS-06	700	PS	06	Cobalt Sulphate Sump Pump		\$ 12,000	0	\$ 11,106											4
1	700-PS-07	700	PS	07	Kerosene Sump Pump		\$ 12,000	0	\$ 11,106											4
1	700-PS-08	700	PS	08	Polyacrylamide Sump Pump		\$ 12,000	0	\$ 11,106											4
1	700-PS-09	700	PS	09	Flocculant Sump Pump		\$ 12,000	0	\$ 11,106											4
1	700-SH-01	700	SH	01	Safety Shower & Eye Wash Station		\$ 4,000	0	\$ 4,000											4
1	700-SH-02	700	SH	02	Safety Shower & Eye Wash Station		\$ 4,000	0	\$ 4,000											4
1	700-SH-03	700	SH	03	Safety Shower & Eye Wash Station		\$ 4,000	0	\$ 4,000											4
1	700-SHD-01	700	SHD	01	Reagent Shed	12x32x6 (w x l x h)	\$ 160,000	0	\$ 160,000											6
1	700-TK-01	700	TK	01	Lime Slurry Distribution Tank	Steel Tank c/w liner, colour bond finish	\$ 7,000	0	\$ 6,806	Pioneer	4	m <sup>3</sup>				50	m <sup>3</sup>		\$ 33,000	2
1	700-TK-02	700	TK	02	Limestone Slurry Distribution Tank	Steel Tank c/w liner, colour bond finish	\$ 16,000	0	\$ 15,837	Pioneer	14	m <sup>3</sup>				50	m <sup>3</sup>		\$ 33,000	2
1	700-TK-03	700	TK	03	Acid Storage Tank	Steel Tank c/w liner, colour bond finish	\$ 38,000	0	\$ 37,867	Pioneer	17	m <sup>3</sup>				390	m <sup>3</sup>		\$ 250,000	2
1	700-TK-04	700	TK	04	LIX Mining Tank	Steel Tank c/w liner, colour bond finish	\$ 5,000	0	\$ 4,162	Pioneer	1.2	m <sup>3</sup>				34	m <sup>3</sup>		\$ 30,954	2
1	700-TK-05	700	TK	05	Kerosene Distribution Tank	Steel Tank c/w liner, colour bond finish	\$ 11,000	0	\$ 10,933	Pioneer	6	m <sup>3</sup>				34	m <sup>3</sup>		\$ 30,954	2
1	800-CP-01	800	CP	01	Air Compressor 1	521 L AS1210-3 Design Approved	\$ 25,000	0	\$ 24,790	S&L Engineering										4
1	800-CP-02	800	CP	02	Air Compressor 2	521 L AS1210-3 Design Approved	\$ 26,000	0	\$ 25,260	S&L Engineering										4
1	800-CZ-01	800	CZ	01	Cooling Tower		\$ 350,000	0	\$ 350,000											4
1	800-DR-01	800	DR	01	Instrument Air Dryer		\$ 18,000	0	\$ 17,715	S&L Engineering										4
1	800-FL-01	800	FL	01	Air System Filter		\$ 18,000	0	\$ 17,715	S&L Engineering										4
1	800-FL-02	800	FL	02	Instrument Air Filter		\$ 18,000	0	\$											

Quantity	Equipment Number	Area Number	Equipment	Tag	Description	Model/Type (equivalent or similar)	Equipment Price (USD)	Estimated Power (kW)	Scaled Cost USD	Supplier	Scaled Capacity	Units	Scaled Power (kW)	Diversity	Diversified Power (kW)	Basis Capacity	Units	Basis Power (kW)	Basis Cost (USD)	Reference
1	800-PP-18	800	PP	18	Cooling Water Distribution Pump (Standby)		\$ 5,000	1	\$ 4,235											4
1	800-PP-19	800	PP	19	Heating Water Pump (Duty)		\$ 5,000	1	\$ 4,235											4
1	800-PP-20	800	PP	20	Heating Water Pump (Standby)		\$ 5,000	1	\$ 4,235											4
1	800-RA-01	800	RA	01	Air Receiver		\$ 18,000	0	\$ 17,715	S&L Engineering										4
1	800-RA-02	800	RA	02	Instrument Air Receiver		\$ 18,000	0	\$ 17,715	S&L Engineering										4
1	800-TK-01	800	TK	01	Plant Potable Water Tank		\$ 37,000	0	\$ 36,960											4
1	800-TK-02	800	TK	02	Plant Potable Water Tank-Mining Area		\$ 37,000	0	\$ 36,960											4
1	800-TK-03	800	TK	03	Safety Shower Water Tank-Mining Area		\$ 37,000	0	\$ 36,960											4
1	800-TK-04	800	TK	04	Safety Shower Water Tank		\$ 37,000	0	\$ 36,960											4
1	800-TK-05	800	TK	05	Diesel Storage Tank		\$ 501,000	0	\$ 500,500											4
1	800-TK-06	800	TK	06	Cooling Water Recycle Tank		\$ 37,000	0	\$ 36,960											4
1	800-TK-07	800	TK	07	Cooling Water Storage Tank		\$ 37,000	0	\$ 36,960											4
1	800-TK-08	800	TK	08	Heating Water Recycle Tank		\$ 37,000	0	\$ 36,960											4
1	0-ME-01	0	ME	01	Workshop Forklift		\$ 35,000	0	\$ 35,000										\$ 17,250	6
1	0-ME-02	0	ME	02	Stores Forklift		\$ 35,000	0	\$ 35,000										\$ 17,250	6
1	0-ME-03	0	ME	03	General/Maintenance Light Vehicles		\$ 35,000	0	\$ 35,000										\$ 14,250	6
1	0-ME-04	0	ME	04	General/Maintenance Light Vehicles		\$ 35,000	0	\$ 35,000										\$ 14,250	6
1	0-ME-05	0	ME	05	General/Maintenance Light Vehicles		\$ 35,000	0	\$ 35,000										\$ 14,250	6
1	0-ME-06	0	ME	06	General/Maintenance Light Vehicles		\$ 35,000	0	\$ 35,000										\$ 14,250	6
1	0-ME-07	0	ME	07	Mobile Lighting Tower		\$ 21,000	0	\$ 20,495										\$ 15,000	6
1	0-ME-08	0	ME	08	Mobile Lighting Tower		\$ 21,000	0	\$ 20,495										\$ 15,000	6
1	0-ME-09	0	ME	09	Mobile Lighting Tower		\$ 21,000	0	\$ 20,495										\$ 15,000	6
1	0-ME-10	0	ME	10	Ambulance		\$ 90,000	0	\$ 90,000										\$ 29,250	6
1	0-ME-11	0	ME	11	Cherry Picker		\$ 116,000	0	\$ 115,500										\$ 87,000	6
1	0-ME-12	0	ME	12	Hoist		\$ 15,000	0	\$ 15,000										\$ 6,000	6
1	0-SHD-01	0	SHD	01	Office/Canteen	16x25x4 (w x l x h)	\$ 80,000	0	\$ 80,000											6
1	0-SHD-02	0	SHD	02	Security Gate House	12x33x4 (w x l x h)	\$ 80,000	0	\$ 80,000											6
1	0-SHD-03	0	SHD	03	Assay Laboratory	8x8x4 (w x l x h)	\$ 56,000	0	\$ 56,000											6
1	0-SHD-04	0	SHD	04	Metallurgical Laboratory	12x33x4 (w x l x h)	\$ 80,000	0	\$ 80,000											6
1	0-SHD-05	0	SHD	05	Stores	12x32x6 (w x l x h)	\$ 80,000	0	\$ 80,000											6
1	0-SHD-06	0	SHD	06	Workshop	12x32x6 (w x l x h)	\$ 80,000	0	\$ 80,000											6
1	0-SHD-07	0	SHD	07	Control Room	8x8x4 (w x l x h)	\$ 56,000	0	\$ 56,000											6
1	0-SHD-08	0	SHD	08	Admin Office	8x8x4 (w x l x h)	\$ 56,000	0	\$ 56,000											6
1	0-SHD-09	0	SHD	09	Medical Centre	8x8x4 (w x l x h)	\$ 56,000	0	\$ 56,000											6
1	0-YTD-01	0	YTD	01	Security Vehicle (4WD)		\$ 54,000	0	\$ 53,960										\$ 40,500	6
1	0-YTD-02	0	YTD	02	Security Vehicle (4WD)		\$ 54,000	0	\$ 53,960										\$ 40,500	6
1	0-YTR-01	0	YTR	01	Water Truck		\$ 193,000	0	\$ 192,500										\$ 144,750	6

Client  
 Deep South Resources  
 Project  
 Hab Leach Project - 8.5 Mtpa @ 85% Cu Recovery/CuSO4  
 Document Number  
 JS459-CAL-000-001

Quantity	Equipment Number	Area Number	Equipment	Tag	Description	Model/Type (equivalent or similar)	Equipment Price (USD)	Estimated Power (kW)	Scaled Cost (USD)	Supplier	Scaled Capacity	Units	Scaled Power (kW)	Diversity	Diversified Power (kW)	Basis Capacity	Units	Basis Power (kW)	Basis Cost (USD)	Reference	
1	100-BN-01	100	BN	01	ROM Bin		\$ 118,000		\$ 117,800	Local Fabrication	148	m <sup>2</sup>				226	m <sup>2</sup>		\$ 151,623	2	
2	100-BN-02-03	100	BN	02-03	Cone Crusher Feed Bin		\$ 420,000		\$ 420,000	Local Fabrication	388	m <sup>2</sup>				74	m <sup>2</sup>		\$ 77,566	2	
1	100-CR-01	100	CR	01	Gyrolator Crusher	CG2R10	\$ 2,065,000	315	\$ 2,064,960	Sandvik	1366	lh	315	0.66	205					\$ 1,800	2
1	100-CR-02-03	100	CR	02-03	Cone Crusher	CH20T03	\$ 2,093,000	1000	\$ 2,092,900	Sandvik	1366	lh	600	0.84	1013					\$ 2,200	2
1	100-CV-01	100	CV	01	Primary Crusher Discharge Conveyor	1200mm x 150 m x 25 m	\$ 330,000	250	\$ 330,000	Sarawest	2792	lh	250	0.85	213	1	m			\$ 2,200	2
2	100-CV-02-03	100	CV	02-03	Cone Crusher Feed Conveyor	1200 mm x 15 m	\$ 54,000	22	\$ 54,000	Sarawest	1366	lh	11	0.85	19	1	m			\$ 1,800	2
1	100-CV-04	100	CV	04	Cone Crusher Discharge Conveyor	1200mm x 100 m x 25 m	\$ 220,000	250	\$ 220,000	Sarawest	2792	lh	250	0.85	213	1	m			\$ 2,200	2
1	100-CV-05	100	CV	05	Screen US Discharge Conveyor	1200mm x 75 m x 10 m	\$ 165,000	160	\$ 165,000	Sarawest	1663	lh	160	0.85	136	1	m			\$ 2,200	2
2	100-CV-06-07	100	CV	06-07	Crushed Ore Discharge Conveyor	1200 mm x 20 m	\$ 72,000	22	\$ 72,000	Sarawest	1366	lh	11	0.85	19	1	m			\$ 1,800	2
1	100-CV-08	100	CV	08	Crushed Product Conveyor	1500 mm x 4500 m x 30 m	\$ 7,650,000	1650	\$ 7,650,000	Sarawest	1663	lh	1650	0.85	1433					\$ 2,200	2
1	100-FE-01	100	FE	01	Primary Crusher Discharge Apron Feeder	Apron Feeder - 1219mm x 6000mm	\$ 318,000	164	\$ 318,319	Sarawest	832	lh	164	0.85	140	450	lh	75	\$ 145,275	2	
2	100-FE-02-03	100	FE	02-03	Cone Crusher Vibrating Feeder	1200 mm x 75 m x 10 m	\$ 213,000	85	\$ 213,000	Sarawest	1366	lh	43	0.75	84	780	lh	30	\$ 75,040	2	
2	100-FE-04-05	100	FE	04-05	Cone Crusher Stockpile Discharge Apron Feeder	Apron Feeder - 1219mm x 6000mm	\$ 421,000	217	\$ 421,012	Sarawest	832	lh	108	0.85	164	450	lh	75	\$ 145,275	2	
3	100-MD-01-03	100	MD	01-03	Metal Detector		\$ 69,000	0	\$ 69,000											\$ 2,200	2
1	100-MG-01	100	MG	01	Tramp Metal Magnet		\$ 50,000	0	\$ 50,000											\$ 2,200	2
1	100-RB-01	100	RB	01	Mobile Rock Breaker		\$ 85,000	0	\$ 85,000											\$ 2,200	2
1	100-SC-01	100	SC	01	Crusher Product Screen	Metsu T86.2 Double-Deck Banana	\$ 590,000	66	\$ 589,825	Metsu	25	m <sup>2</sup>	66	0.85	56	26	m <sup>2</sup>		\$ 600,000	2	4
1	100-SH-01	100	SH	01	Primary Crusher Area Safety Shower and Eyewash Station		\$ 4,000	0	\$ 4,000											\$ 2,200	2
1	100-SH-02	100	SH	02	Screening Area Safety Shower and Eyewash Station		\$ 4,000	0	\$ 4,000											\$ 2,200	2
1	100-SH-03	100	SH	03	Cone Crusher Safety Shower and Eyewash Station		\$ 4,000	0	\$ 4,000											\$ 2,200	2
1	100-SV-01	100	SV	01	Surge Vault		\$ 154,000	0	\$ 157,542	Local Fabrication	257	m <sup>2</sup>				300	m <sup>2</sup>		\$ 173,000	2	4
1	100-WS-01-04	100	WS	01-04	Water Sprayer		\$ 50,000	0	\$ 50,000											\$ 2,200	2
7	100-WT-01-07	100	WT	01-07	Weightmaster		\$ 228,000	0	\$ 228,000											\$ 2,200	2
1	100-SHD-01	100	SHD	01	Crusher Control Room		\$ 25,000	0	\$ 24,283											\$ 2,200	2
1	100-YFL-01	100	YFL	01	Front End Loader		\$ 500,000	0	\$ 500,000											\$ 2,200	2
1	100-SP-01	100	SP	01	Crushed Product Stockpile		\$ 1,000,000	0	\$ 1,000,000											\$ 2,200	2
1	200-SP-01	200	SP	01	HPGR Feed Stockpile		\$ 1,600,000	0	\$ 1,600,000											\$ 2,200	2
2	200-BN-01-02	200	BN	01-02	Screen Feed Bin		\$ 161,000	0	\$ 161,000	Local Fabrication	78	m <sup>2</sup>				74	m <sup>2</sup>		\$ 77,566	2	
2	200-BN-03-04	200	BN	03-04	Screen Feed Bin		\$ 161,000	0	\$ 161,000	Local Fabrication	78	m <sup>2</sup>				74	m <sup>2</sup>		\$ 77,566	2	
2	200-CV-01-02	200	CV	01-02	Stockpile Discharge Conveyor	1200 mm x 20 m	\$ 72,000	22	\$ 72,000	Sarawest	647	lh	11	0.85	19	1	m		\$ 1,800	2	
2	200-CV-03-04	200	CV	03-04	Crusher Feed Conveyor	1200mm x 150 m x 25 m	\$ 330,000	160	\$ 330,000	Sarawest	1663	lh	160	0.85	136	1	m		\$ 2,200	2	
2	200-CV-04-05	200	CV	04-05	HPGR Feeders	1200 mm x 15 m	\$ 54,000	22	\$ 54,000	Sarawest	841	lh	11	0.85	19	1	m		\$ 1,800	2	
1	200-CV-06	200	CV	06	Screen Feed Conveyor	1200mm x 100 m x 25 m	\$ 180,000	180	\$ 180,000	Sarawest	1662	lh	160	0.85	136	1	m		\$ 1,800	2	
1	200-CV-07	200	CV	07	Stockpile Discharge Conveyor	1200 mm x 100 m x 25 m	\$ 180,000	180	\$ 180,000	Sarawest	1662	lh	160	0.85	136	1	m		\$ 1,800	2	
2	200-FE-01-02	200	FE	01-02	HPGR Stockpile Apron Feeder	1200 mm x 75 m x 10 m	\$ 362,000	187	\$ 362,000	Sarawest	847	lh	93	0.85	159	450	lh	75	\$ 145,275	2	
2	200-FE-03-04	200	FE	03-04	HPGR Vibrating Feeder		\$ 158,000	83	\$ 158,000	Sarawest	841	lh	31	0.85	53	780	lh	30	\$ 75,040	2	
2	200-FE-05-06	200	FE	05-06	Crusher Vibrating Feeder		\$ 158,000	83	\$ 158,000	Sarawest	841	lh	31	0.85	53	780	lh	30	\$ 75,040	2	
2	200-GR-01-02	200	GR	01-02	HPGR		\$ 7,626,000	5200	\$ 7,626,000	Koepfer	841	lh	2600	0.75	3925					\$ 2,200	2
2	200-MD-01-02	200	MD	01-02	Metal Detector		\$ 69,000	0	\$ 69,000											\$ 2,200	2
2	200-SC-01	200	SC	01	Grinding Area Safety Shower and Eyewash Station	Metsu T86.2 Double-Deck Banana	\$ 590,000	112	\$ 589,825	Metsu	25	m <sup>2</sup>	66	0.75	99	26	m <sup>2</sup>		\$ 600,000	2	4
1	200-SH-01	200	SH	01	Grinding Area Safety Shower and Eyewash Station		\$ 4,000	0	\$ 4,000											\$ 2,200	2
1	200-SH-02	200	SH	02	Screen Area Safety Shower and Eyewash Station		\$ 4,000	0	\$ 4,000											\$ 2,200	2
1	200-WS-01-03	200	WS	01-03	Water Sprayer		\$ 50,000	0	\$ 50,000											\$ 2,200	2
6	200-WT-01-06	200	WT	01-06	Weightmaster		\$ 196,000	0	\$ 196,000											\$ 2,200	2
1	200-YFL-01	200	YFL	01	Front End Loader		\$ 500,000	0	\$ 500,000											\$ 2,200	2
2	300-AD-01-02	300	AD	01-02	Agglomerator Drum		\$ 2,700,000	480	\$ 2,700,000	Sepro Systems	170	m <sup>2</sup>	240	0.75	360					\$ 2,200	2
1	300-BN-01	300	BN	01	Agglomerator Feed Bin		\$ 118,000	0	\$ 118,000	Local Fabrication	150	m <sup>2</sup>				74	m <sup>2</sup>		\$ 77,566	2	4
1	300-CH-01	300	CH	01	Filter Press Discharge Chute	Constructed On Site	\$ 5,000	0	\$ 4,500	Local Fabrication										\$ 2,200	2
1	300-CV-01	300	CV	01	Agglomerator Feed Conveyor	1200 mm x 75 m x 25 m	\$ 330,000	80	\$ 330,000	Krupp	1294	lh	80	0.85	68	1	m		\$ 2,200	2	
1	300-CV-02	300	CV	02	Agglomerator Product Conveyor	1200 mm x 150 m x 50 m	\$ 330,000	160	\$ 330,000	Krupp	1426	lh	160	0.85	136	1	m		\$ 2,200	2	
10	300-CV-0X	300	CV	0X	Grasshopper Conveyor	1200 mm x 50 m x 2.5 m	\$ 1,000,000	200	\$ 1,000,000	Sarawest	1426	lh	20	0.85	170	1	m		\$ 2,000	2	
1	300-CV-03	300	CV	03	Radial Stackler for Primary Leach Heap	Radial Stackler for Primary Leach Heap	\$ 51,000	84	\$ 51,000	Krupp	1426	lh	84	0.85	71	1520	lh		\$ 600,000	2	4
1	300-CV-04	300	CV	04	Neutralized Tailings Transfer Conveyor	600 mm x 20 m x 5 m	\$ 36,000	21	\$ 36,000	Sarawest	47	lh	21	0.85	18	1	m		\$ 1,800	2	4
1	300-FE-01	300	FE	01	Belt Feeder		\$ 233,000	23	\$ 232,374	Metsu	1294	lh	23	0.85	20	320	lh	10	\$ 100,500	2	4
1	300-IR-01	300	IR	01	Primary Heap Leach Drip Irrigation		\$ 117,000	0	\$ 117,000											\$ 2,200	2
1	300-IR-02	300	IR	02	Secondary Heap Leach Drip Irrigation		\$ 117,000	0	\$ 117,000											\$ 2,200	2
1	300-IR-03	300	IR	03	Wash Heap Leach Drip Irrigation		\$ 117,000	0	\$ 117,000											\$ 2,200	2
1	300-PP-01	300	PP	01	Baren Pond		\$ 1,217,000	0	\$ 1,216,800											\$ 2,200	2
1	300-PD-02	300	PD	02	LS Pond		\$ 1,217,000	0	\$ 1,217,000											\$ 2,200	2
1	300-PD-03	300	PD	03	Active Solution Pond		\$ 1,217,000	0	\$ 1,216,800											\$ 2,200	2
1	300-PP-01	300	PP	01	pH Adjustment Thickener Feed Pump (Duty)	SDB 200/250-Centrifugal	\$ 58,000	161	\$ 57,667	1949	m <sup>3</sup> /h	161	0.75	121	1400	m <sup>3</sup> /h	132	\$ 47,279	2	4	
1	300-PP-02	300	PP	02	pH Adjustment Thickener Feed Pump (Standby)	SDB 200/250-Centrifugal	\$ 58,000	161	\$ 57,667	1949	m <sup>3</sup> /h	161	0.00	0	1400	m <sup>3</sup> /h	132	\$ 47,279	2	4	
1	300-PP-03	300	PP	03	pH Adjustment Filter Press Feed Pump (Duty)	SDB 200/250-Centrifugal	\$ 58,000	161	\$ 57,667	1949	m <sup>3</sup> /h	161	0.75	121	1400	m <sup>3</sup> /h	132	\$ 47,279	2	4	
1	300-PP-04	300	PP	04	pH Adjustment Filter Press Feed Pump (Standby)	SDB 200/250-Centrifugal	\$ 58,000	161	\$ 57,667	1949	m <sup>3</sup> /h	161	0.00	0	1400	m <sup>3</sup> /h	132	\$ 47,279	2	4	
1	300-PP-05	300	PP	05	pH Adjustment Filtrate Pump (Duty)	SDB 200/250-Centrifugal	\$ 58,000	161	\$ 57,667	1949	m <sup>3</sup> /h	161	0.75	121	1400	m <sup>3</sup> /h	132	\$ 47,279	2	4	
1	300-PP-06	300	PP	06	pH Adjustment Filtrate Pump (Standby)	SDB 200/250-Centrifugal	\$ 58,000	161	\$ 57,667	1949	m <sup>3</sup> /h	161	0.00	0	1400	m <sup>3</sup> /h	132	\$ 47,279	2	4	
1	300-PP-07	300	PP	07	pH Adjustment Thickener Overflow Pump (Duty)	SDB 200/250-Centrifugal	\$ 68,532	191	\$ 68,532	2999	m <sup>3</sup> /h	191	0.75	144	1400	m <sup>3</sup> /h	132	\$ 47,279	2	4	
1	300-PP-08	300	PP	08	pH Adjustment Thickener Overflow Pump (Standby)	SDB 200/250-Centrifugal	\$ 68,532	191	\$ 68,532	2999	m <sup>3</sup> /h	191	0.00	0	1400	m <sup>3</sup> /h	132	\$ 47,279	2	4	
1	300-PP-09	300	PP	09	LS Pump (Duty)	SDB 200/250-C															

Quantity	Equipment Number	Area Number	Equipment	Tag	Description	Model/Type (equivalent or similar)	Equipment Price (USD)	Estimated Power (kW)	Scaled Cost (USD)	Supplier	Scaled Capacity	Units	Scaled Power (kW)	Diversity	Diversified Power (kW)	Basis Capacity	Units	Basis Power (kW)	Basis Cost (USD)	Reference
1	400-HE-03	400	HE	03	Heater and Cooling System	SX Feed Intercooler-MMFG	\$ 8,000	0	\$ 7,500	Alfa Laval										4
1	400-HE-04	400	HE	04	Heater and Cooling System	SX Feed Intercooler-MMFG	\$ 8,000	0	\$ 7,500	Alfa Laval										4
1	400-HE-05	400	HE	05	Heater and Cooling System	SX Feed Intercooler-MMFG	\$ 8,000	0	\$ 7,500	Alfa Laval										4
1	400-HE-06	400	HE	06	Heater and Cooling System	SX Feed Intercooler-MMFG	\$ 8,000	0	\$ 7,500	Alfa Laval										4
1	400-HE-07	400	HE	07	Heater and Cooling System	SX Feed Intercooler-MMFG	\$ 8,000	0	\$ 7,500	Alfa Laval										4
1	400-HE-08	400	HE	08	Heater and Cooling System	SX Feed Intercooler-MMFG	\$ 8,000	0	\$ 7,500	Alfa Laval										4
1	400-HE-09	400	HE	09	Heater and Cooling System	SX Feed Intercooler-MMFG	\$ 8,000	0	\$ 7,500	Alfa Laval										4
1	400-HE-10	400	HE	10	Heater and Cooling System	SX Feed Intercooler-MMFG	\$ 8,000	0	\$ 7,500	Alfa Laval										4
1	400-ME-01	400	ME	01	Crane		\$ 150,000	0	\$ 150,000				150	0.85	128					6
1	400-PK-01	400	PK	01	Copper Sulfate Crystalliser Vendor Package		\$ 1,250,000	0	\$ 1,250,000				50	0.85	43					6
1	400-PK-02	400	PK	02	Copper Sulfate Packaging Package		\$ 400,000	0	\$ 400,000				5	0.85	6					6
1	400-PP-01	400	PP	01	pH Adjustment Tank Pump (Duty)	MC 200-355	\$ 81,000	143	\$ 80,929	Weir	1971	m³/h	143	0.75	107	402	m³/h	55	\$ 31,170	2
1	400-PP-02	400	PP	02	pH Adjustment Tank Pump (Standby)	MC 200-355	\$ 81,000	143	\$ 80,929	Weir	1971	m³/h	143	0.00	0	402	m³/h	55	\$ 31,170	2
1	400-PP-03	400	PP	03	Thickener Underflow Pump (Duty)	MC 200-355	\$ 3,000	4	\$ 2,122	Weir	5	m³/h	4	0.75	3	402	m³/h	55	\$ 31,170	2
1	400-PP-04	400	PP	04	Thickener Underflow Pump (Standby)	MC 200-355	\$ 3,000	4	\$ 2,122	Weir	5	m³/h	4	0.00	0	402	m³/h	55	\$ 31,170	2
1	400-PP-05	400	PP	05	Filtrate Recycling Pump (Duty)	MC 200-355	\$ 2,200	3	\$ 1,766	Weir	3	m³/h	3	0.75	2	402	m³/h	55	\$ 31,170	2
1	400-PP-06	400	PP	06	Filtrate Recycling Pump (Standby)	MC 200-355	\$ 2,200	3	\$ 1,766	Weir	3	m³/h	3	0.00	0	402	m³/h	55	\$ 31,170	2
1	400-PP-07	400	PP	07	Polishing Filter Pump (Duty)	MC 200-355	\$ 81,000	143	\$ 80,929	Weir	1968	m³/h	143	0.75	107	402	m³/h	55	\$ 31,170	2
1	400-PP-08	400	PP	08	Polishing Filter Pump (Standby)	MC 200-355	\$ 81,000	143	\$ 80,929	Weir	1968	m³/h	143	0.00	0	402	m³/h	55	\$ 31,170	2
1	400-PP-09	400	PP	09	Copper SX PLS Feed Pump (Duty)	MC 200-355	\$ 81,000	143	\$ 80,929	Weir	1968	m³/h	143	0.75	107	402	m³/h	55	\$ 31,170	2
1	400-PP-10	400	PP	10	Copper SX PLS Feed Pump (Standby)	MC 200-355	\$ 81,000	143	\$ 80,929	Weir	1968	m³/h	143	0.00	0	402	m³/h	55	\$ 31,170	2
1	400-PP-11	400	PP	11	Organic Transfer Pump (Duty)	MC 200-355	\$ 81,000	143	\$ 80,929	Weir	1968	m³/h	143	0.75	107	402	m³/h	55	\$ 31,170	2
1	400-PP-12	400	PP	12	Organic Transfer Pump (Standby)	MC 200-355	\$ 81,000	143	\$ 80,929	Weir	1968	m³/h	143	0.00	0	402	m³/h	55	\$ 31,170	2
1	400-PP-13	400	PP	13	Copper Extraction Crud Transfer Pump (Duty)	Peristaltic Pump	\$ 6,000	1	\$ 5,404	Flowrex	1	m³/h	1	0.75	1	0.53	m³/h	0.75	\$ 3,692	2
1	400-PP-14	400	PP	14	Copper Extraction Crud Transfer Pump (Standby)	Peristaltic Pump	\$ 6,000	1	\$ 5,404	Flowrex	1	m³/h	1	0.00	0	0.53	m³/h	0.75	\$ 3,692	2
1	400-PP-15	400	PP	15	Raffinate Pump (Duty)	MC 200-355	\$ 81,000	143	\$ 80,929	Weir	1968	m³/h	143	0.75	107	402	m³/h	55	\$ 31,170	2
1	400-PP-16	400	PP	16	Raffinate Pump (Standby)	MC 200-355	\$ 81,000	143	\$ 80,929	Weir	1968	m³/h	143	0.00	0	402	m³/h	55	\$ 31,170	2
1	400-PP-17	400	PP	17	Loaded Organic Pump (Duty)	MC 200-355	\$ 81,000	78	\$ 80,929	Weir	1968	m³/h	78	0.75	58	402	m³/h	30	\$ 31,170	2
1	400-PP-18	400	PP	18	Loaded Organic Pump (Standby)	MC 200-355	\$ 81,000	78	\$ 80,929	Weir	1968	m³/h	78	0.00	0	402	m³/h	30	\$ 31,170	2
1	400-PP-19	400	PP	19	Copper Extraction Crud Transfer Pump (Duty)	Peristaltic Pump	\$ 6,000	1	\$ 5,404	Flowrex	1	m³/h	1	0.75	1	0.53	m³/h	0.75	\$ 3,692	2
1	400-PP-20	400	PP	20	Copper Extraction Crud Transfer Pump (Standby)	Peristaltic Pump	\$ 6,000	1	\$ 5,404	Flowrex	1	m³/h	1	0.00	0	0.53	m³/h	0.75	\$ 3,692	2
1	400-PP-21	400	PP	21	Raffinate Pump (Duty)	GEKONORM NM 32-160	\$ 29,000	19	\$ 28,732	Weir	1968	m³/h	19	0.75	15	402	m³/h	7.5	\$ 11,080	2
1	400-PP-22	400	PP	22	Raffinate Pump (Standby)	GEKONORM NM 32-160	\$ 29,000	19	\$ 28,732	Weir	1968	m³/h	19	0.00	0	402	m³/h	7.5	\$ 11,080	2
1	400-PP-23	400	PP	23	Loaded Organic Pump (Duty)	MC 200-355	\$ 81,000	78	\$ 80,929	Weir	1968	m³/h	78	0.75	58	402	m³/h	30	\$ 31,170	2
1	400-PP-24	400	PP	24	Loaded Organic Pump (Standby)	MC 200-355	\$ 81,000	78	\$ 80,929	Weir	1968	m³/h	78	0.00	0	402	m³/h	30	\$ 31,170	2
1	400-PP-25	400	PP	25	Shipping Feed Pump (Duty)	MC 200-355	\$ 81,000	143	\$ 80,929	Weir	1968	m³/h	143	0.75	107	402	m³/h	55	\$ 31,170	2
1	400-PP-26	400	PP	26	Shipping Feed Pump (Standby)	MC 200-355	\$ 81,000	143	\$ 80,929	Weir	1968	m³/h	143	0.00	0	402	m³/h	55	\$ 31,170	2
1	400-PP-27	400	PP	27	Shipping Liquor Pump (Duty)	GEKONORM NM 32-160	\$ 6,000	4	\$ 5,255	Weir	116	m³/h	4	0.75	3	402	m³/h	7.5	\$ 11,080	2
1	400-PP-28	400	PP	28	Shipping Liquor Pump (Standby)	GEKONORM NM 32-160	\$ 6,000	4	\$ 5,255	Weir	116	m³/h	4	0.00	0	402	m³/h	7.5	\$ 11,080	2
1	400-PP-29	400	PP	29	Copper Stripping Crud Transfer Pump (Duty)	Peristaltic Pump	\$ 6,000	1	\$ 5,404	Flowrex	1	m³/h	1	0.75	1	0.53	m³/h	0.75	\$ 3,692	2
1	400-PP-30	400	PP	30	Copper Stripping Crud Transfer Pump (Standby)	Peristaltic Pump	\$ 6,000	1	\$ 5,404	Flowrex	1	m³/h	1	0.00	0	0.53	m³/h	0.75	\$ 3,692	2
1	400-PP-31	400	PP	31	Loaded Stripping Solution Sump Pump (Duty)	MC 200-355	\$ 15,000	14	\$ 14,782	Weir	116	m³/h	14	0.75	11	402	m³/h	30	\$ 31,170	2
1	400-PP-32	400	PP	32	Loaded Stripping Solution Sump Pump (Standby)	MC 200-355	\$ 15,000	14	\$ 14,782	Weir	116	m³/h	14	0.00	0	402	m³/h	30	\$ 31,170	2
1	400-PP-33	400	PP	33	Baren Organic Pump (Duty)	GEKONORM NM 32-160	\$ 29,000	19	\$ 28,732	Weir	1968	m³/h	19	0.75	15	402	m³/h	7.5	\$ 11,080	2
1	400-PP-34	400	PP	34	Baren Organic Pump (Standby)	GEKONORM NM 32-160	\$ 29,000	19	\$ 28,732	Weir	1968	m³/h	19	0.00	0	402	m³/h	7.5	\$ 11,080	2
1	400-PP-35	400	PP	35	Copper Stripping Crud Transfer Pump (Duty)	Peristaltic Pump	\$ 6,000	1	\$ 5,404	Flowrex	1	m³/h	1	0.75	1	0.53	m³/h	0.75	\$ 3,692	2
1	400-PP-36	400	PP	36	Copper Stripping Crud Transfer Pump (Standby)	Peristaltic Pump	\$ 6,000	1	\$ 5,404	Flowrex	1	m³/h	1	0.00	0	0.53	m³/h	0.75	\$ 3,692	2
1	400-PP-37	400	PP	37	Loaded Aqueous Pump (Duty)	MC 200-355	\$ 15,000	26	\$ 14,782	Weir	116	m³/h	26	0.75	20	402	m³/h	55	\$ 31,170	2
1	400-PP-38	400	PP	38	Loaded Aqueous Pump (Standby)	MC 200-355	\$ 15,000	26	\$ 14,782	Weir	116	m³/h	26	0.00	0	402	m³/h	55	\$ 31,170	2
1	400-PP-39	400	PP	39	Stripped Organic Pump (Duty)		\$ 48,000	8	\$ 47,949	Weir	1968	m³/h	7.8	0.75	6	75	m³/h	1.1	\$ 6,752	2
1	400-PP-40	400	PP	40	Stripped Organic Pump (Standby)		\$ 48,000	8	\$ 47,949	Weir	1968	m³/h	7.8	0.00	0	75	m³/h	1.1	\$ 6,752	2
1	400-PP-41	400	PP	41	Scrubbing SX Crud Transfer Pump (Duty)	Peristaltic Pump	\$ 6,000	1	\$ 5,404	Flowrex	1	m³/h	1	0.75	1	0.53	m³/h	0.75	\$ 3,692	2
1	400-PP-42	400	PP	42	Scrubbing SX Crud Transfer Pump (Standby)	Peristaltic Pump	\$ 6,000	1	\$ 5,404	Flowrex	1	m³/h	1	0.00	0	0.53	m³/h	0.75	\$ 3,692	2
1	400-PP-43	400	PP	43	Scrubbing Solution Recirculation Pump (Duty)	MC 200-355	\$ 81,000	78	\$ 80,929	Weir	1968	m³/h	78	0.75	58	402	m³/h	30	\$ 31,170	2
1	400-PP-44	400	PP	44	Scrubbing Solution Recirculation Pump (Standby)	MC 200-355	\$ 81,000	78	\$ 80,929	Weir	1968	m³/h	78	0.00	0	402	m³/h	30	\$ 31,170	2
1	400-PP-45	400	PP	45	Organic Transfer Pump (Duty)	MC 200-355	\$ 81,000	143	\$ 80,929	Weir	1968	m³/h	143	0.75	107	402	m³/h	55	\$ 31,170	2
1	400-PP-46	400	PP	46	Organic Transfer Pump (Standby)	MC 200-355	\$ 81,000	143	\$ 80,929	Weir	1968	m³/h	143	0.00	0	402	m³/h	55	\$ 31,170	2
1	400-PP-47	400	PP	47	SX Waste Pump (Duty)		\$ 2,200	1	\$ 1,330	Weir	5	m³/h	1	0.75	1	75	m³/h	1.1	\$ 6,752	2
1	400-PP-48	400	PP	48	SX Waste Pump (Standby)		\$ 2,200	1	\$ 1,330	Weir	5	m³/h	1	0.00	0	75	m³/h	1.1	\$ 6,752	2
1	400-PP-49	400	PP	49	Crud Treatment Tank Discharge Pump (Duty)	Peristaltic Pump	\$ 15,000	3	\$ 14,193	Flowrex	5	m³/h	3	0.75	3	0.53	m³/h	0.75	\$ 3,692	2
1	400-PP-50	400	PP	50	Crud Treatment Tank Discharge Pump (Standby)	Peristaltic Pump	\$ 15,000	3	\$ 14,193	Flowrex										

Quantity	Equipment Number	Area Number	Equipment	Tag	Description	Model/Type (Equivalent or similar)	Equipment Price (USD)	Estimated Power (kW)	Scaled Cost USD	Supplier	Scaled Capacity	Units	Scaled Power (kW)	Diversity	Diversified Power (kW)	Basis Capacity	Units	Basis Power (kW)	Basis Cost (USD)	Reference		
1	500-PP-01	500	PP	01	Precipitation Tank Pump (Duty)	SDB 200/250/Centrifugal	\$ 12,000	32	\$ 11,464	Weir	132	m <sup>3</sup> /h	32	0.75	24	1400	m <sup>3</sup> /h	132	\$ 47,279	2		
1	500-PP-02	500	PP	02	Precipitation Tank Pump (Standby)	SDB 200/250/Centrifugal	\$ 12,000	32	\$ 11,464	Weir	132	m <sup>3</sup> /h	32	0.00	0	1400	m <sup>3</sup> /h	132	\$ 47,279	2		
1	500-PP-03	500	PP	03	Thickener U/F Pump (Duty)	SDB 200/250/Centrifugal	\$ 11,000	28	\$ 10,065	Weir	106	m <sup>3</sup> /h	28	0.75	21	1400	m <sup>3</sup> /h	132	\$ 47,279	2		
1	500-PP-04	500	PP	04	Thickener U/F Pump (Standby)	SDB 200/250/Centrifugal	\$ 11,000	28	\$ 10,065	Weir	106	m <sup>3</sup> /h	28	0.00	0	1400	m <sup>3</sup> /h	132	\$ 47,279	2		
1	500-PP-05	500	PP	05	Barren Solution Pond Feed Pump (Duty)	Warman 3x2AH	\$ 24,000	14	\$ 23,671	Weir	726	m <sup>3</sup> /h	14	0.75	11	150	m <sup>3</sup> /h	5.5	\$ 9,188	2		
1	500-PP-06	500	PP	06	Barren Solution Pond Feed Pump (Standby)	Warman 3x2AH	\$ 24,000	14	\$ 23,671	Weir	726	m <sup>3</sup> /h	14	0.00	0	150	m <sup>3</sup> /h	5.5	\$ 9,188	2		
1	500-PP-07	500	PP	07	Filter Feed Pump (Duty)	Warman 3x2AH	\$ 8,000	4	\$ 7,471	Weir	106	m <sup>3</sup> /h	4	0.75	3	150	m <sup>3</sup> /h	5.5	\$ 9,188	2		
1	500-PP-08	500	PP	08	Filter Feed Pump (Standby)	Warman 3x2AH	\$ 8,000	4	\$ 7,471	Weir	106	m <sup>3</sup> /h	4	0.00	0	150	m <sup>3</sup> /h	5.5	\$ 9,188	2		
1	500-PP-09	500	PP	09	Filtrate Pump (Duty)	Warman 3x2AH	\$ 5,000	3	\$ 4,524	Weir	46	m <sup>3</sup> /h	3	0.75	2	150	m <sup>3</sup> /h	5.5	\$ 9,188	2		
1	500-PP-10	500	PP	10	Filtrate Pump (Standby)	Warman 3x2AH	\$ 5,000	3	\$ 4,524	Weir	46	m <sup>3</sup> /h	3	0.00	0	150	m <sup>3</sup> /h	5.5	\$ 9,188	2		
1	500-PP-11	500	PP	11	Filtrate Pump (Duty)	Warman 3x2AH	\$ 5,000	3	\$ 4,524	Weir	46	m <sup>3</sup> /h	3	0.75	2	150	m <sup>3</sup> /h	5.5	\$ 9,188	2		
1	500-PP-12	500	PP	12	Filtrate Pump (Standby)	Warman 3x2AH	\$ 5,000	3	\$ 4,524	Weir	46	m <sup>3</sup> /h	3	0.00	0	150	m <sup>3</sup> /h	5.5	\$ 9,188	2		
1	500-PS-01	500	PS	01	Thickener Sump Pump		\$ 12,000	0	\$ 11,106											4		
1	500-PS-02	500	PS	02	Filter Press Sump Pump		\$ 12,000	0	\$ 11,106												4	
1	500-PS-03	500	PS	03	Filter Press Sump Pump		\$ 12,000	0	\$ 11,106												4	
1	500-SH-01	500	SH	01	Safety Shower and Eyewash Station		\$ 4,000	0	\$ 4,000												4	
1	500-TH-01	500	TH	01	Thickener		\$ 596,000	0	\$ 595,632	Waterex	27	m				20	m		\$ 499,800	2		
1	500-TK-01	500	TK	01	Precipitation Tank	GL13/04 Steel 6.02m D x 4.27m, 122kL	\$ 131,000	0	\$ 130,511	Pioneer	132	m <sup>3</sup>					390	m <sup>3</sup>		\$ 250,000	2	
1	500-TK-02	500	TK	02	Iron Tailings Filter Feed Tank	GL13/04 Steel 6.02m D x 4.27m, 122kL	\$ 131,000	0	\$ 130,511	Pioneer	132	m <sup>3</sup>					390	m <sup>3</sup>		\$ 250,000	2	
1	500-TK-03	500	TK	03	Raffinate Recycle Tank	GL13/04 Steel 6.02m D x 4.27m, 122kL	\$ 16,000	0	\$ 15,455	Pioneer	61	m <sup>3</sup>					122	m <sup>3</sup>		\$ 23,379	3	
2	500-YTR-01-02	500	YTR	01-02	Tailings Haul Truck		\$ 280,000	0	\$ 140,000												6	
1	600-DM-01	600	DM	01	Earthwork and Rehabilitation		\$ 850,000	0	\$ 850,000												6	
1	600-DM-01	600	DM	01	Mining Raw Water Dam	10000 m3	\$ 260,000	0	\$ 260,000		10000	m <sup>3</sup>					1	m <sup>3</sup>		\$ 26	2	
1	600-DM-02	600	DM	02	Raw Water Dam	5m x 60m x 60m (h x l x w) 18000 m3	\$ 525,000	0	\$ 524,160		20160	m <sup>3</sup>						1	m <sup>3</sup>		\$ 26	2
1	600-PP-01	600	PP	01	Raw Water Transfer Pump (Duty)	Warman 3x2AH	\$ 13,000	119	\$ 12,571	Linatex	168	m <sup>3</sup> /h	119	0.75	89	200	m <sup>3</sup> /h	132	\$ 13,973	2		
1	600-PP-02	600	PP	02	Raw Water Transfer Pump (Standby)	Warman 3x2AH	\$ 13,000	119	\$ 12,571	Linatex	168	m <sup>3</sup> /h	119	0.00	0	200	m <sup>3</sup> /h	132	\$ 13,973	2		
1	600-PP-03	600	PP	03	Process Water Distribution Pump (Duty)	20x18 pump	\$ 8,000	72	\$ 7,569	Linatex	72	m <sup>3</sup> /h	72	0.75	54	200	m <sup>3</sup> /h	132	\$ 13,973	2		
1	600-PP-04	600	PP	04	Process Water Distribution Pump (Standby)	20x18 pump	\$ 8,000	72	\$ 7,569	Linatex	72	m <sup>3</sup> /h	72	0.00	0	200	m <sup>3</sup> /h	132	\$ 13,973	2		
1	600-PP-05	600	PP	05	Raw Water Transfer Pump (Duty)	Warman 3x2AH	\$ 13,000	119	\$ 12,571	Linatex	168	m <sup>3</sup> /h	119	0.75	89	200	m <sup>3</sup> /h	132	\$ 13,973	2		
1	600-PP-06	600	PP	06	Raw Water Transfer Pump (Standby)	Warman 3x2AH	\$ 13,000	119	\$ 12,571	Linatex	168	m <sup>3</sup> /h	119	0.00	0	200	m <sup>3</sup> /h	132	\$ 13,973	2		
1	600-PP-07	600	PP	07	Process Water Distribution Pump (Duty)	20x18 pump	\$ 8,000	72	\$ 7,569	Linatex	72	m <sup>3</sup> /h	72	0.75	54	200	m <sup>3</sup> /h	132	\$ 13,973	2		
1	600-PP-08	600	PP	08	Process Water Distribution Pump (Standby)	20x18 pump	\$ 8,000	72	\$ 7,569	Linatex	72	m <sup>3</sup> /h	72	0.00	0	200	m <sup>3</sup> /h	132	\$ 13,973	2		
1	600-PP-09	600	PP	09	Diesel Fire Pump	Water Pump	\$ 4,000	11	\$ 3,338	Linatex	35	m <sup>3</sup> /h	11	0.75	8	35	m <sup>3</sup> /h	11	\$ 3,338	4		
1	600-PP-10	600	PP	10	Electric Fire Pump	Water Pump	\$ 4,000	11	\$ 3,338	Linatex	35	m <sup>3</sup> /h	11	0.75	8	35	m <sup>3</sup> /h	11	\$ 3,338	4		
1	600-PP-11	600	PP	11	Jockey Fire Pump	Water Pump	\$ 4,000	11	\$ 3,338	Linatex	35	m <sup>3</sup> /h	11	0.75	8	35	m <sup>3</sup> /h	11	\$ 3,338	4		
1	600-PP-12	600	PP	12	Gland Seal Water Distribution Pump (Duty)		\$ 2,000	5	\$ 1,574		10	m <sup>3</sup> /h	5	0.75	4	35	m <sup>3</sup> /h	11	\$ 3,338	2		
1	600-PP-13	600	PP	13	Gland Seal Water Distribution Pump (Standby)		\$ 2,000	5	\$ 1,574		10	m <sup>3</sup> /h	5	0.00	0	35	m <sup>3</sup> /h	11	\$ 3,338	2		
1	600-PP-14	600	PP	14	Raw Water Distribution Pump (Duty)	Water Pump	\$ 9,000	28	\$ 8,545	Linatex	168	m <sup>3</sup> /h	28	0.75	21	35	m <sup>3</sup> /h	11	\$ 3,338	2		
1	600-PP-15	600	PP	15	Raw Water Distribution Pump (Standby)	Water Pump	\$ 9,000	28	\$ 8,545	Linatex	168	m <sup>3</sup> /h	28	0.00	0	35	m <sup>3</sup> /h	11	\$ 3,338	2		
1	600-TK-01	600	TK	01	Process Water Distribution Tank-Mining Area	Steel Tank with rubber liners, colourbond finish	\$ 78,000	0	\$ 77,383	Pioneer	360	m <sup>3</sup>				2660	m <sup>3</sup>		\$ 258,916	2		
1	600-TK-02	600	TK	02	Raw Water Distribution Tank	Water Tank	\$ 333,000	0	\$ 332,062	Pioneer	4090	m <sup>3</sup>				2660	m <sup>3</sup>		\$ 258,916	4		
1	600-TK-03	600	TK	03	Process Water Distribution Tank-Processing Area	Steel Tank with rubber liners, colourbond finish	\$ 204,000	0	\$ 203,248	Pioneer	1800	m <sup>3</sup>				2660	m <sup>3</sup>		\$ 258,916	2		
1	700-AG-01	700	AG	01	Lime Slurry Distribution Tank Agitator	1.4 m dia x 2.8 m	\$ 2,000	1	\$ 1,278	Mixtec	4	m <sup>2</sup>	1	0.85	1	33	m <sup>2</sup>	2.2	\$ 4,829	2		
1	700-AG-02	700	AG	02	Limestone/Calcrete Slurry Distribution Tank Agitator	3.4 m dia x 6.8 m	\$ 4,000	4	\$ 3,809	Mixtec	14	m <sup>2</sup>	4	0.85	3	86	m <sup>2</sup>	11	\$ 11,423	2		
1	700-AG-03	700	AG	03	LIX Mixing Tank Agitator	1 m dia x 2 m	\$ 1,000	0	\$ 661	Mixtec	1.2	m <sup>2</sup>	0.3	0.85	0	33	m <sup>2</sup>	2.2	\$ 4,829	2		
1	700-BN-01	700	BN	01	Quicklime Feed Silo		\$ 114,000	0	\$ 113,008	Local Fabrication	26	m <sup>3</sup>				100	m <sup>3</sup>		\$ 251,273	2		
1	700-BN-02	700	BN	02	Limestone/Calcrete Feed Silo		\$ 142,000	0	\$ 141,496	Local Fabrication	38	m <sup>3</sup>				100	m <sup>3</sup>		\$ 251,273	2		
1	700-FE-01	700	FE	01	Quicklime Feeder	Belt Feeder	\$ 4,000	2	\$ 3,026	Metsu	0.9	thr	2	0.75	2	320	thr	10	\$ 100,500	3		
1	700-FE-02	700	FE	02	Limestone/Calcrete Feeder	Belt Feeder	\$ 8,000	1	\$ 7,396	Metsu	4.1	thr	1	0.75	1	320	thr	10	\$ 100,500	3		
1	700-MH-01	700	MH	01	Bulk Bag Monitor and Hoist		\$ 18,000	0	\$ 18,000	Eilbeck Cranes											2	
1	700-ME-01	700	ME	01	Forklift		\$ 30,000	0	\$ 30,000												6	
1	700-ME-02	700	ME	02	Crane		\$ 150,000	0	\$ 150,000												6	
1	700-ME-03	700	ME	03	Crane		\$ 150,000	0	\$ 150,000												6	
1	700-PK-01	700	PK	01	Lime Staking Mill		\$ 450,000	0	\$ 450,000												2	
1	700-PK-02	700	PK	02	Gum Vendor Package		\$ 250,000	0	\$ 250,000												4	
1	700-PK-03	700	PK	03	Cobalt Sulphate Vendor Package		\$ 50,000	0	\$ 50,000												4	
1	700-PK-04	700	PK	04	Polycrylamide Vendor Package		\$ 250,000	0	\$ 250,000												4	
1	700-PK-05	700	PK	05	Flocculant Vendor Package		\$ 71,000	2	\$ 70,067	Transmin	8.17	kg/hr	2	0.50	1	218	kg/hr	15	\$ 502,785	2		
1	700-PP-01	700	PP	01	Lime Transfer Pump (Duty)		\$ 4,000	1	\$ 4,000	Allied Colloids	0.9	m <sup>3</sup> /h	0.1	0.75	0	75	m <sup>3</sup> /h	1.1	\$ 6,752	2		
1	700-PP-02	700	PP	02	Lime Transfer Pump (Standby)		\$ 4,000	1	\$ 4,000	Allied Colloids	0.9	m <sup>3</sup> /h	0.1	0.00	0	75	m <sup>3</sup> /h	1.1	\$ 6,752	2		
1	700-PP-03	700	PP	03	Lime Metering Pump (Duty)		\$ 4,000	1	\$ 4,000	Allied Colloids</												

Quantity	Equipment Number	Area Number	Equipment	Tag	Description	Model/Type (equivalent or similar)	Equipment Price (USD)	Estimated Power (kW)	Scaled Cost (USD)	Supplier	Scaled Capacity	Units	Scaled Power (kW)	Diversity	Diversified Power (kW)	Basis Capacity	Units	Basis Power (kW)	Basis Cost (USD)	Reference
1	700-PS-02	700	PS	02	Limestone Sump Pump		\$ 12,000	0	\$ 11,106											4
1	700-PS-03	700	PS	03	Acid Sump Pump		\$ 12,000	0	\$ 11,106											4
1	700-PS-04	700	PS	04	LIX Sump Pump		\$ 12,000	0	\$ 11,106											4
1	700-PS-05	700	PS	05	Guar Gum Sump Pump		\$ 12,000	0	\$ 11,106											4
1	700-PS-06	700	PS	06	Cobalt Sulphate Sump Pump		\$ 12,000	0	\$ 11,106											4
1	700-PS-07	700	PS	07	Kerosene Sump Pump		\$ 12,000	0	\$ 11,106											4
1	700-PS-08	700	PS	08	Polyacrylamide Sump Pump		\$ 12,000	0	\$ 11,106											4
1	700-PS-09	700	PS	09	Flocculant Sump Pump		\$ 12,000	0	\$ 11,106											4
1	700-SH-01	700	SH	01	Safety Shower & Eye Wash Station		\$ 4,000	0	\$ 4,000											4
1	700-SH-02	700	SH	02	Safety Shower & Eye Wash Station		\$ 4,000	0	\$ 4,000											4
1	700-SH-03	700	SH	03	Safety Shower & Eye Wash Station		\$ 4,000	0	\$ 4,000											4
1	700-SHD-01	700	SHD	01	Reagent Shed	12x20x6 (w x l x h)	\$ 160,000	0	\$ 160,000											6
1	700-TK-01	700	TK	01	Lime Slurry Distribution Tank	Steel Tank c/w liner, colour bond finish	\$ 7,000	0	\$ 6,806	Pioneer	4	m <sup>3</sup>				50	m <sup>3</sup>		\$ 33,000	2
1	700-TK-02	700	TK	02	Limestone Slurry Distribution Tank	Steel Tank c/w liner, colour bond finish	\$ 16,000	0	\$ 15,637	Pioneer	14	m <sup>3</sup>				50	m <sup>3</sup>		\$ 33,000	2
1	700-TK-03	700	TK	03	Acid Storage Tank	Steel Tank c/w liner, colour bond finish	\$ 78,000	0	\$ 77,351	Pioneer	55	m <sup>3</sup>				390	m <sup>3</sup>		\$ 250,000	2
1	700-TK-04	700	TK	04	LIX Mixing Tank	Steel Tank c/w liner, colour bond finish	\$ 5,000	0	\$ 4,162	Pioneer	1.2	m <sup>3</sup>				34	m <sup>3</sup>		\$ 30,954	2
1	700-TK-05	700	TK	05	Kerosene Distribution Tank	Steel Tank c/w liner, colour bond finish	\$ 11,000	0	\$ 10,933	Pioneer	6	m <sup>3</sup>				34	m <sup>3</sup>		\$ 30,954	2

Client  
 Deep South Resources  
 Project  
 Hab Leach Project - 20 Mtpa @ 80% Cu Recovery+CuSO4  
 Document Number  
 J5459-CAL-000-001

Quantity	Equipment Number	Area Number	Equipment	Tag	Description	Model/Type (equivalent or similar)	Equipment Price (USD)	Estimated Power (kW)	Scaled Cost USD	Supplier	Scaled Capacity	Units	Scaled Power (kW)	Diversity	Diversified Power (kW)	Basis Capacity	Units	Basis Power (kW)	Basis Cost (USD)	Reference	
1	100-BN-01	100	BN	01	ROM Bin		\$ 197,000		\$ 196,940	Local Fabrication	349	m <sup>3</sup>				236	m <sup>3</sup>		\$ 151,623	2	
5	100-BN-02-06	100	BN	02-06	Cone Crusher Feed Bin		\$ 996,000		\$ 999,145	Local Fabrication	356	m <sup>3</sup>				74	m <sup>3</sup>		\$ 77,586	2	
3	100-BN-07-09	100	BN	07-09	Screen Feed Bin		\$ 812,000		\$ 270,570	Local Fabrication	593	m <sup>3</sup>				74	m <sup>3</sup>		\$ 77,586	2	
1	100-CR-01	100	CR	01	Gratory Crusher	CG830	\$ 4,536,000	660	\$ 4,536,000	Sandvik	3914	th	660	0.66	436						6
5	100-CR-02-06	100	CR	02-06	Cone Crusher	CH870-03	\$ 5,231,000	3000	\$ 1,046,139	Sandvik	1282	th	600	0.84	2534						6
1	100-CV-01	100	CV	01	Primary Crusher Discharge Conveyor	1200mm x 150 m x 25 m	\$ 330,000	550	\$ 330,000	Sanwest	6408	th	550	0.85	468	1	m		\$ 2,200	2	
5	100-CV-02-06	100	CV	02-06	Cone Crusher Feed Conveyor	1200mm x 150 m x 25 m	\$ 135,000	55	\$ 27,000	Sanwest	1282	th	11	0.85	47	1	m		\$ 1,800	2	
1	100-CV-07	100	CV	07	Cone Crusher Discharge Conveyor	1200mm x 100 m x 25 m	\$ 220,000	550	\$ 220,000	Sanwest	6408	th	550	0.85	468	1	m		\$ 2,200	2	
1	100-CV-08	100	CV	08	Screen U/S Discharge Conveyor	1200mm x 75 m x 10 m	\$ 165,000	350	\$ 165,000	Sanwest	3914	th	350	0.85	298	1	m		\$ 2,200	2	
2	100-CV-09-10	100	CV	09-10	Crushed Ore Discharge Conveyor	1200 mm x 20 m	\$ 72,000	22	\$ 36,000	Sanwest	1957	th	11	0.85	19	1	m		\$ 1,800	2	
1	100-TP-01	100	TP	01	Crushed Product Conveyor	1200 mm x 4500 m x 30 m	\$ 9,900,000	2020	\$ 9,900,000	Sanwest	3914	th	2020	0.85	1717						2
1	100-FE-01	100	FE	01	Primary Crusher Discharge Apron Feeder	Apron Feeder - 1219mm x 6000mm	\$ 532,000	275	\$ 531,899	Sanwest	3914	th	275	0.85	233	450	th	39	\$ 75,040	2	
5	100-FE-02-08	100	FE	02-08	Cone Crusher Vibrating Feeder		\$ 508,000	202	\$ 191,085	Sanwest	1282	th	40	0.85	172	780	th	10	\$ 74,000	2	
3	100-FE-07-09	100	FE	07-09	Crushed Product Screen Feeders	1200 mm x 15 m	\$ 694,000	94	\$ 231,155	Sanwest	2136	th	31	0.75	216	320	th	10	\$ 74,000	2	
2	100-FE-10-11	100	FE	10-11	Crushed Ore Stockpile Apron Feeder	Apron Feeder - 1219mm x 6000mm	\$ 702,000	362	\$ 350,922	Sanwest	1957	th	181	0.85	308	450	th	75	\$ 145,275	2	
6	100-MD-01-06	100	MD	01-06	Metal Detector		\$ 138,000	0	\$ 23,000											4	
1	100-MG-01	100	MG	01	Tramp Metal Magnet		\$ 50,000	0	\$ 50,000											4	
1	100-RB-01	100	RB	01	Mobile Rock Breaker		\$ 88,000	0	\$ 87,150											4	
3	100-SC-01-03	100	SC	01-03	Crusher Product Screen	Metso TSS 2 Double-Deck Banana	\$ 1,548,000	198	\$ 515,914	Metso	20	m <sup>2</sup>	66	0.85	168	26	m <sup>2</sup>		\$ 600,000	2	
1	100-SH-01	100	SH	01	Primary Crusher Area Safety Shower and Eyewash Station		\$ 4,000	0	\$ 4,000												4
1	100-SH-02	100	SH	02	Screening Area Safety Shower and Eyewash Station		\$ 4,000	0	\$ 4,000												4
1	100-SH-03	100	SH	03	Cone Crusher Safety Shower and Eyewash Station		\$ 4,000	0	\$ 4,000												4
1	100-SV-01	100	SV	01	Surge Vault		\$ 294,000	0	\$ 293,999	Local Fabrication	725	m <sup>3</sup>				300	m <sup>3</sup>		\$ 173,000	2	
1	100-TP-02	100	TP	02	Screen Feed Tripper Conveyor		\$ 2,200,000	80	\$ 2,200,000		1282	th	80	0.85	68						4
1	100-TP-03	100	TP	03	Screen Feed Tripper Conveyor		\$ 2,200,000	80	\$ 2,200,000		6408	th	80	0.85	68						4
1	100-WS-01-04	100	WS	01-04	Water Sprayer		\$ 50,000	0	\$ 50,000												4
10	100-WT-01-10	100	WT	01-10	Weightmeter		\$ 325,000	0	\$ 32,500												4
1	100-SHD-01	100	SHD	01	Crusher Control Room		\$ 25,000	0	\$ 24,283												4
1	100-YFL-01	100	YFL	01	Front End Loader		\$ 500,000	0	\$ 500,000												4
1	100-SP-01	100	SP	01	Crushed Product Stockpile		\$ 1,354,000	0	\$ 1,353,123		46967	t				62100			\$ 1,600,000	4	
1	200-SP-01	200	SP	01	HPGR Feed Stockpile		\$ 2,674,000	0	\$ 2,674,000		146119	t				62100			\$ 1,600,000	4	
2	200-BN-01-02	200	BN	01-02	HPGR Feed Bin		\$ 517,000		\$ 258,432		550	m <sup>3</sup>				74	m <sup>3</sup>		\$ 77,586	2	
4	200-BN-03-06	200	BN	03-06	Screen Feed Bin		\$ 683,000		\$ 170,511	Local Fabrication	275	m <sup>3</sup>				74	m <sup>3</sup>		\$ 77,586	2	
2	200-CV-01-02	200	CV	01-02	Stockpile Discharge Conveyor	1200 mm x 20 m	\$ 72,000	22	\$ 36,000	Sanwest	1522	th	11	0.85	19	1	m		\$ 1,800	2	
1	200-CV-03	200	CV	03	HPGR Feed Conveyor	1200mm x 150 m x 25 m	\$ 330,000	350	\$ 330,000	Sanwest	3957	th	350	0.85	298	1	m		\$ 2,200	2	
2	200-CV-04-05	200	CV	04-05	HPGR Feed Conveyors	1200 mm x 15 m	\$ 54,000	22	\$ 27,000	Sanwest	1979	th	11	0.85	19	1	m		\$ 1,800	2	
1	200-CV-06	200	CV	06	Screen Feed Conveyor	1200mm x 100 m x 25 m	\$ 180,000	300	\$ 180,000	Sanwest	3044	th	300	0.85	255	1	m		\$ 1,800	2	
1	200-CV-07	200	CV	07	Screen Discharge Conveyor	1200 mm x 75 m x 10 m	\$ 150,000	120	\$ 150,000	Sanwest	3044	th	120	0.85	102	1	m		\$ 2,000	2	
2	200-FE-01-02	200	FE	01-02	HPGR Stockpile Apron Feeder		\$ 604,000	312	\$ 301,803	Sanwest	1522	th	156	0.85	285	450	th	75	\$ 145,275	2	
2	200-FE-03-04	200	FE	03-04	HPGR Vibrating Feeder		\$ 283,000	105	\$ 131,179	Sanwest	1979	th	52	0.85	89	780	th	30	\$ 75,040	2	
4	200-FE-05-08	200	FE	05-08	Screen Vibrating Feeder		\$ 347,000	138	\$ 86,546	Sanwest	989	th	35	0.85	118	780	th	30	\$ 75,040	2	
2	200-GR-01-02	200	GR	01-02	HPGR	HPGR 63017.6-OWH-1230-PG1E	\$ 13,595,000	9600	\$ 6,797,084	Koepvern	1979	th	4800	0.75	7245						2
2	200-MD-01-02	200	MD	01-02	Metal Detector		\$ 46,000	0	\$ 23,000												4
4	200-SC-01-04	200	SC	01-04	HPGR Screens	Metso TS6 2 Double-Deck Banana	\$ 2,064,000	264	\$ 515,914	Metso	20	m <sup>2</sup>	66	0.75	198	26	m <sup>2</sup>		\$ 600,000	2	
1	200-SH-01	200	SH	01	Grinding Area Safety Shower and Eyewash Station		\$ 4,000	0	\$ 4,000												4
1	200-SH-02	200	SH	02	Screen Area Safety Shower and Eyewash Station		\$ 4,000	0	\$ 4,000												4
1	200-TP-01	200	TP	01	Screen Feed Tripper Conveyor		\$ 2,200,000	80	\$ 2,200,000												4
1	200-WS-01-03	200	WS	01-03	Water Sprays		\$ 50,000	0	\$ 50,000												4
6	200-WT-01-06	200	WT	01-06	Weightmeter		\$ 195,000	0	\$ 32,500												4
1	200-YFL-01	200	YFL	01	Front End Loader		\$ 500,000	0	\$ 500,000												4
4	300-AD-01-04	300	AD	01-04	Agglomerator Drum	3610	\$ 5,400,000	960	\$ 1,350,000	Sepro Systems	400	m <sup>3</sup>	240	0.75	720						2
1	300-BN-01	300	BN	01	Agglomerator Feed Bin		\$ 198,000		\$ 197,511	Local Fabrication	352	m <sup>3</sup>				74	m <sup>3</sup>		\$ 77,586	2	
1	300-CH-01	300	CH	01	Filter Press Discharge Chute	Constructed On Site	\$ 5,000	0	\$ 4,500	Local Fabrication											4
1	300-CV-01	300	CV	01	Agglomerator Feed Conveyor	1200 mm x 75 m x 25 m	\$ 165,000	125	\$ 165,000	Krupp	3044	th	125	0.85	106	1	m		\$ 2,200	2	
2	300-CV-02-03	300	CV	02-03	Agglomerator Feed Conveyors	1200 mm x 75 m x 25 m	\$ 330,000	22	\$ 165,000	Krupp	1522	th	11	0.85	19	1	m		\$ 2,200	2	
1	300-CV-04	300	CV	04	Agglomerator Product Conveyor	1200 mm x 150 m x 50 m	\$ 330,000	300	\$ 330,000	Krupp	3356	th	300	0.85	255	1	m		\$ 2,200	2	
6	300-CV-05-09	300	CV	05-09	Grasshopper Conveyors	1200 mm x 50 m x 2.5 m	\$ 600,000	240	\$ 100,000	Sanwest	3356	th	40	0.85	204	1	m		\$ 2,200	2	
1	300-CV-10	300	CV	10	Radial Stacker for Primary Leach Heap	Roll Mounted Radial Stacker. 1200 mm x 50 m x 15 m	\$ 887,000	100	\$ 886,788	Krupp	3356	th	100	0.85	85	1750	th		\$ 600,000	2	
1	300-CV-11	300	CV	11	Neutralised Tailings Transfer Conveyor	800 mm x 20 m x 5 m	\$ 36,000	21	\$ 36,000	Sanwest	5	th	21	0.85	18	1	m		\$ 1,800	2	
1	300-FE-01	300	FE	01	Belt Feeder	Belt Feeder	\$ 389,000	39	\$ 388,289	Metso	3044	th	39	0.85	33	320	th	10	\$ 100,500	2	
1	300-IR-01	300	IR	01	Primary Heap Leach Drip Irrigation		\$ 117,000	0	\$ 117,000		120000	m				1	m <sup>3</sup>		\$ 1	2	
1	300-IR-02	300	IR	02	Secondary Heap Leach Drip Irrigation		\$ 117,000	0	\$ 117,000		120000	m				1	th		\$ 1	2	
1	300-IR-03	300	IR	03	Wash Heap Leach Drip Irrigation		\$ 117,000	0	\$ 117,000		120000	m				1	th		\$ 1	2	
1	300-PD-01	300	PD	01	Barren Pond		\$ 2,865,000	0	\$ 2,864,160		110160	m <sup>3</sup>				1	m <sup>2</sup>		\$ 26	3	
1	300-PD-02	300	PD	02	LS Pond		\$ 2,865,000	0	\$ 2,864,160		110160	m <sup>2</sup>				1	m <sup>2</sup>		\$ 26	3	
1	300-PD-03	300	PD	03	Active Solution Pond		\$ 2,865,000	0	\$ 2,864,160		110160	m <sup>3</sup>				1	m <sup>2</sup>		\$ 26	3	
1	300-PP-01	300	PP	01	pH Adjustment Thickener Feed Pump (Duty)		\$ 87,000	241	\$ 86,375		3822	m <sup>3</sup> /h	241	0.75	181	1400	m <sup>3</sup> /h	132	\$ 47,279	2	
1	300-PP-02	300	PP	02	pH Adjustment Thickener Feed Pump (Standby)		\$ 87,000	241	\$ 86,375		3822	m <sup>3</sup> /h	241	0.00	0	1400	m <sup>3</sup> /h	132	\$ 47,279	2	
1	300-PP-03	300	PP	03	pH Adjustment Filter Press Feed Pump (Duty)		\$ 87,000	241	\$ 86,375		3822	m <sup>3</sup> /h	241	0.75	181	1400	m <sup>3</sup> /h	132	\$ 47,279	2	
1	300-PP-04	300	PP	04	pH Adjustment Filter Press Feed Pump (Standby)		\$ 87,000	241	\$ 86,375		3822	m <sup>3</sup> /h	241	0.00	0	1400	m <sup>3</sup> /h	132	\$ 47,279	2	
1	300-PP-05	300	PP	05	p																

Quantity	Equipment Number	Area Number	Equipment	Tag	Description	Model/Type (equivalent or similar)	Equipment Price (USD)	Estimated Power (kW)	Scaled Cost USD	Supplier	Scaled Capacity	Units	Scaled Power (kW)	Diversity	Diversified Power (kW)	Basis Capacity	Units	Basis Power (kW)	Basis Cost (USD)	Reference
1	300-PP-16	300	PP	16	Cu SX Feed Pump (Standby)	SDB 200/250-Centrifugal	\$ 97,000	271	\$ 96,998		4638	m <sup>3</sup> h	271	0.00	0	1400	m <sup>3</sup> h	132	\$ 47,279	2
3	300-SH-01-03	300	SH	01-03	Safety Shower and Eye Wash Station		\$ 12,000	0	\$ 4,000											4
1	300-YFL-01	300	YFL	01	Front End Loader		\$ 500,000	0	\$ 500,000											4
1	300-HX-01	300	HX	01	Pipe Heat Exchanger		\$ 1,300,000	0	\$ 1,299,604		129960	m <sup>2</sup>								4
1	300-HX-02	300	HX	02	Pipe Heat Exchanger		\$ 1,560,000	0	\$ 1,559,525		155953	m <sup>2</sup>								4
1	300-HX-03	300	HX	03	Pipe Heat Exchanger		\$ 2,080,000	0	\$ 2,079,367		207937	m <sup>2</sup>								4
1	300-TK-01	300	TK	01	pH Adjustment Tank		\$ 294,000	0	\$ 293,538	Pioneer	510	m <sup>3</sup>				390	m <sup>3</sup>		\$ 250,000	2
1	300-AG-01	300	AG	01	pH Adjustment Tank Agitator	5 m dia x 10 m	\$ 56,000	32	\$ 55,751	Lightnin	388	m <sup>3</sup>	32	0.85	27	354	m <sup>3</sup>	30	\$ 52,799	2
1	300-TH-01	300	TH	01	pH Adjustment Thickener		\$ 247,000	0	\$ 246,561	Waterlex	6	m				20	m		\$ 499,800	2
1	300-FL-01	300	FL	01	pH Adjustment Filter Press		\$ 49,000	11	\$ 48,057		4	thr	11	0.85	10	50	thr	50	\$ 214,286	2
1	400-AG-01	400	AG	01	pH Adjustment Tank Agitator	5 m dia x 10 m	\$ 56,000	32	\$ 55,751	Lightnin	388	m <sup>3</sup>	32	0.85	27	354	m <sup>3</sup>	30	\$ 52,799	2
1	400-AG-02	400	AG	02	Organic Control Tank Agitator	5 m dia x 10 m	\$ 56,000	32	\$ 55,647	Lightnin	386	m <sup>3</sup>	32	0.85	27	354	m <sup>3</sup>	30	\$ 52,799	2
1	400-AG-03	400	AG	03	Copper Extraction Mixer Settler Agitator	4.2 m dia x 8.4 m	\$ 41,000	23	\$ 40,940	Lightnin	232	m <sup>3</sup>	23	0.85	20	354	m <sup>3</sup>	30	\$ 52,799	2
1	400-AG-04	400	AG	04	Copper Extraction Mixer Settler Agitator	4.2 m dia x 8.4 m	\$ 41,000	23	\$ 40,940	Lightnin	232	m <sup>3</sup>	23	0.85	20	354	m <sup>3</sup>	30	\$ 52,799	2
1	400-AG-05	400	AG	05	Stripping Liquor Tank Agitator	2m dia x 4 m	\$ 4,000	2	\$ 3,868	Lightnin	23	m <sup>3</sup>	2	0.85	2	33	m <sup>3</sup>	2.2	\$ 4,829	2
1	400-AG-06	400	AG	06	Scrubbing Solution Tank Agitator	3.4 m dia x 10 m	\$ 56,000	32	\$ 55,647	Lightnin	386	m <sup>3</sup>	32	0.85	27	354	m <sup>3</sup>	30	\$ 52,799	2
1	400-AG-07	400	AG	07	Copper Stripping Mixer Settler Agitator	3.4 m dia x 6.8 m	\$ 28,000	16	\$ 27,953	Lightnin	123	m <sup>3</sup>	16	0.85	14	354	m <sup>3</sup>	30	\$ 52,799	2
1	400-AG-08	400	AG	08	Copper Stripping Mixer Settler Agitator	3.4 m dia x 6.8 m	\$ 28,000	16	\$ 27,953	Lightnin	123	m <sup>3</sup>	16	0.85	14	354	m <sup>3</sup>	30	\$ 52,799	2
1	400-AG-09	400	AG	09	Scrubbing Mixer Settler Agitator	3.4 m dia x 6.8 m	\$ 15,000	14	\$ 14,135	Lightnin	123	m <sup>3</sup>	14	0.85	12	86	m <sup>3</sup>	11	\$ 11,423	2
1	400-AG-10	400	AG	10	SX Waste Tank Agitator	2.8 m dia x 5.6 m	\$ 7,000	6	\$ 6,072	Lightnin	30	m <sup>3</sup>	6	0.85	5	86	m <sup>3</sup>	11	\$ 11,423	2
1	400-AG-11	400	AG	11	Crud Treatment Tank Agitator	2.8 m dia x 5.6 m	\$ 7,000	6	\$ 6,072	Lightnin	30	m <sup>3</sup>	6	0.85	5	86	m <sup>3</sup>	11	\$ 11,423	2
1	400-BN-01	400	BN	01	Copper Sulfate Product Bin		\$ 33,000	0	\$ 32,001		17	m <sup>3</sup>				74	m <sup>3</sup>		\$ 77,966	4
1	400-CF-01	400	CF	01	Crud Centrifuge		\$ 249,000	18	\$ 248,817		3	thr	18	0.85	16	8	thr	37	\$ 500,000	2
1	400-CH-01	400	CH	01	Filter Press Discharge Chute	Constructed On Site	\$ 5,000	0	\$ 4,500	Local fabrication										4
1	400-CV-01	400	CV	01	Neutralised Tailings Transfer Conveyor	600 mm x 20 m x 10 m	\$ 360,000	21	\$ 360,000	Sanwest	5	thr	21	0.85	18	1	m		\$ 1,800	2
2	400-CV-02-03	400	CV	02-03	Stripped Sheet Conveyor	600 mm x 20 m	\$ 72,000	22	\$ 36,000	Sanwest	2	thr	11	0.85	19	1	m		\$ 1,800	2
2	400-CV-04-05	400	CV	04-05	Cathode Discharge Conveyor	600 mm x 20 m	\$ 72,000	22	\$ 36,000	Sanwest	3	thr	11	0.85	19	1	m		\$ 1,800	2
1	400-CV-06	400	CV	06	Wet Copper Sulphate Conveyor	600 mm x 20 m	\$ 36,000	11	\$ 36,000	Sanwest	16	thr	11	0.85	9	1	m		\$ 1,800	2
1	400-CV-07	400	CV	07	Copper Sulphate Product Conveyor	600 mm x 20 m	\$ 36,000	11	\$ 36,000	Sanwest	6	thr	11	0.85	9	1	m		\$ 1,800	2
188	400-EC-01-188	400	EC	01-188	Electrowinning Cells		\$ 12,691,000	10083	\$ 12,690,727		38337	tpa	1.00	10083	11000	tpa			\$ 6,000,000	4
1	400-FD-01	400	FD	01	Flash Crying Circuit		\$ 952,000	156	\$ 951,623	Svedata	16	thr	156	0.85	133	10	thr	120	\$ 730,000	2
1	400-FE-01	400	FE	01	Flash Dryer Feeder		\$ 74,000	42	\$ 73,798		16	thr	42	0.85	35	1	thr	8	\$ 14,220	2
2	400-FL-01-02	400	FL	01-02	pH Adjusting Filter Press	Pressure filter Dia/med Me1500.2800.MB	\$ 97,000	22	\$ 48,057		4	thr	11	0.85	19	50	thr	50	\$ 214,286	2
3	400-FL-03-05	400	FL	03-05	Polishing Filter		\$ 1,537,000	237	\$ 1,532,172		1544	m <sup>3</sup> h	79	0.85	202	720	m <sup>3</sup> h	50	\$ 324,000	2
1	400-HE-01	400	HE	01	Heater and Cooling System	SX Feed Intercooler-MMFNG	\$ 8,000	0	\$ 7,500	Alfa Laval										4
1	400-HE-02	400	HE	02	Heater and Cooling System	SX Feed Intercooler-MMFNG	\$ 8,000	0	\$ 7,500	Alfa Laval										4
1	400-HE-03	400	HE	03	Heater and Cooling System	SX Feed Intercooler-MMFNG	\$ 8,000	0	\$ 7,500	Alfa Laval										4
1	400-HE-04	400	HE	04	Heater and Cooling System	SX Feed Intercooler-MMFNG	\$ 8,000	0	\$ 7,500	Alfa Laval										4
1	400-HE-05	400	HE	05	Heater and Cooling System	SX Feed Intercooler-MMFNG	\$ 8,000	0	\$ 7,500	Alfa Laval										4
1	400-HE-06	400	HE	06	Heater and Cooling System	SX Feed Intercooler-MMFNG	\$ 8,000	0	\$ 7,500	Alfa Laval										4
1	400-HE-07	400	HE	07	Heater and Cooling System	SX Feed Intercooler-MMFNG	\$ 8,000	0	\$ 7,500	Alfa Laval										4
1	400-HE-08	400	HE	08	Heater and Cooling System	SX Feed Intercooler-MMFNG	\$ 8,000	0	\$ 7,500	Alfa Laval										4
1	400-HE-09	400	HE	09	Heater and Cooling System	SX Feed Intercooler-MMFNG	\$ 8,000	0	\$ 7,500	Alfa Laval										4
1	400-HE-10	400	HE	10	Heater and Cooling System	SX Feed Intercooler-MMFNG	\$ 8,000	0	\$ 7,500	Alfa Laval										4
2	400-MC-01-02	400	MC	01-02	Crane		\$ 300,000	0	\$ 150,000				150	0.85	128				6	
1	400-PK-01	400	PK	01	Copper Sulfate Crystalliser Vendor Package		\$ 1,250,000		\$ 400,000		8		50	0.85	43					6
1	400-PK-02	400	PK	02	Copper Sulfate Packaging Package		\$ 400,000		\$ 400,000											
1	400-PP-01	400	PP	01	pH Adjustment Tank Pump (Duty)	MC 200-355	\$ 138,000	239	\$ 135,200	Weir	4638	m <sup>3</sup> h	239	0.75	179	402	m <sup>3</sup> h	55	\$ 31,170	2
1	400-PP-02	400	PP	02	pH Adjustment Tank Pump (Standby)	MC 200-355	\$ 138,000	239	\$ 135,200	Weir	4638	m <sup>3</sup> h	239	0.00	0	402	m <sup>3</sup> h	55	\$ 31,170	2
1	400-PP-03	400	PP	03	Thickener Underflow Pump (Duty)	MC 200-355	\$ 3,000	4	\$ 2,404	Weir	6	m <sup>3</sup> h	4	0.75	3	402	m <sup>3</sup> h	55	\$ 31,170	2
1	400-PP-04	400	PP	04	Thickener Underflow Pump (Standby)	MC 200-355	\$ 3,000	4	\$ 2,404	Weir	6	m <sup>3</sup> h	4	0.00	0	402	m <sup>3</sup> h	55	\$ 31,170	2
1	400-PP-05	400	PP	05	Filtrate Recycling Pump (Duty)	MC 200-355	\$ 3,000	4	\$ 2,001	Weir	4	m <sup>3</sup> h	4	0.75	3	402	m <sup>3</sup> h	55	\$ 31,170	2
1	400-PP-06	400	PP	06	Filtrate Recycling Pump (Standby)	MC 200-355	\$ 3,000	4	\$ 2,001	Weir	4	m <sup>3</sup> h	4	0.00	0	402	m <sup>3</sup> h	55	\$ 31,170	2
1	400-PP-07	400	PP	07	Polishing Filter Pump (Duty)	MC 200-355	\$ 138,000	238	\$ 135,128	Weir	4633	m <sup>3</sup> h	238	0.75	179	402	m <sup>3</sup> h	55	\$ 31,170	2
1	400-PP-08	400	PP	08	Polishing Filter Pump (Standby)	MC 200-355	\$ 138,000	238	\$ 135,128	Weir	4633	m <sup>3</sup> h	238	0.00	0	402	m <sup>3</sup> h	55	\$ 31,170	2
1	400-PP-09	400	PP	09	Copper SX PLUS Feed Pump (Duty)	MC 200-355	\$ 138,000	238	\$ 135,128	Weir	4633	m <sup>3</sup> h	238	0.75	179	402	m <sup>3</sup> h	55	\$ 31,170	2
1	400-PP-10	400	PP	10	Copper SX PLUS Feed Pump (Standby)	MC 200-355	\$ 138,000	238	\$ 135,128	Weir	4633	m <sup>3</sup> h	238	0.00	0	402	m <sup>3</sup> h	55	\$ 31,170	2
1	400-PP-11	400	PP	11	Organic Transfer Pump (Duty)	MC 200-355	\$ 138,000	238	\$ 135,128	Weir	4633	m <sup>3</sup> h	238	0.75	179	402	m <sup>3</sup> h	55	\$ 31,170	2
1	400-PP-12	400	PP	12	Organic Transfer Pump (Standby)	MC 200-355	\$ 138,000	238	\$ 135,128	Weir	4633	m <sup>3</sup> h	238	0.00	0	402	m <sup>3</sup> h	55	\$ 31,170	2
1	400-PP-13	400	PP	13	Copper Extraction Crud Transfer Pump (Duty)	Peristaltic Pump	\$ 6,000	1	\$ 5,404	Flowrex	1	m <sup>3</sup> h	1	0.75	1	0.53	m <sup>3</sup> h	0.75	\$ 3,692	2
1	400-PP-14	400	PP	14	Copper Extraction Crud Transfer Pump (Standby)	Peristaltic Pump	\$ 6,000	1	\$ 5,404	Flowrex	1	m <sup>3</sup> h	1	0.00	0	0.53	m <sup>3</sup> h	0.75	\$ 3,692	2
1																				



Quantity	Equipment Number	Area Number	Equipment	Tag	Description	Model/Type (equivalent or similar)	Equipment Price (USD)	Estimated Power (kW)	Scaled Cost USD	Supplier	Scaled Capacity	Units	Scaled Power (kW)	Diversity	Diversified Power (kW)	Basis Capacity	Units	Basis Power (kW)	Basis Cost (USD)	Reference
1	400-PP-42	400	PP	42	Scrubbing SX Crud Transfer Pump (Standby)	Peristaltic Pump	\$ 6,000	1	\$ 5,404	Flowrex	1	m <sup>3</sup> /h	1	0.00	0	0.53	m <sup>3</sup> /h	0.75	\$ 3,692	2
1	400-PP-43	400	PP	43	Scrubbing Solution Recirculation Pump (Duty)	MC 200-355	\$ 136,000	130	\$ 135,128	Weir	4633	m <sup>3</sup> /h	130	0.75	98	402	m <sup>3</sup> /h	30	\$ 31,170	2
1	400-PP-44	400	PP	44	Scrubbing Solution Recirculation Pump (Standby)	MC 200-355	\$ 136,000	130	\$ 135,128	Weir	4633	m <sup>3</sup> /h	130	0.00	0	402	m <sup>3</sup> /h	30	\$ 31,170	2
1	400-PP-45	400	PP	45	Organic Transfer Pump (Duty)	MC 200-355	\$ 136,000	238	\$ 135,128	Weir	4633	m <sup>3</sup> /h	238	0.75	179	402	m <sup>3</sup> /h	55	\$ 31,170	2
1	400-PP-46	400	PP	46	Organic Transfer Pump (Standby)	MC 200-355	\$ 136,000	238	\$ 135,128	Weir	4633	m <sup>3</sup> /h	238	0.00	0	402	m <sup>3</sup> /h	55	\$ 31,170	2
1	400-PP-47	400	PP	47	SX Waste Pump (Duty)	MC 200-355	\$ 2,000	1	\$ 1,330	Weir	5	m <sup>3</sup> /h	1	0.75	1	75	m <sup>3</sup> /h	1.1	\$ 6,752	2
1	400-PP-48	400	PP	48	SX Waste Pump (Standby)	MC 200-355	\$ 2,000	1	\$ 1,330	Weir	5	m <sup>3</sup> /h	1	0.00	0	75	m <sup>3</sup> /h	1.1	\$ 6,752	2
1	400-PP-49	400	PP	49	Crud Treatment Tank Discharge Pump (Duty)	Peristaltic Pump	\$ 15,000	3	\$ 14,193	Flowrex	5	m <sup>3</sup> /h	3	0.75	2	0.53	m <sup>3</sup> /h	0.75	\$ 3,692	2
1	400-PP-50	400	PP	50	Crud Treatment Tank Discharge Pump (Standby)	Peristaltic Pump	\$ 15,000	3	\$ 14,193	Flowrex	5	m <sup>3</sup> /h	3	0.00	0	0.53	m <sup>3</sup> /h	0.75	\$ 3,692	2
1	400-PP-51	400	PP	51	Centrate Recycle Pump (Duty)	MC 200-355	\$ 3,000	4	\$ 2,242	Weir	5	m <sup>3</sup> /h	4	0.75	3	402	m <sup>3</sup> /h	55	\$ 31,170	2
1	400-PP-52	400	PP	52	Centrate Recycle Pump (Standby)	MC 200-355	\$ 3,000	4	\$ 2,242	Weir	5	m <sup>3</sup> /h	4	0.00	0	402	m <sup>3</sup> /h	55	\$ 31,170	2
2	400-PP-53/05	400	PP	53/05	Electrowinning Feed Pump (Duty)	MC 200-355	\$ 23,000	4	\$ 11,075	Weir	171	m <sup>3</sup> /h	2	0.75	3	75	m <sup>3</sup> /h	1.1	\$ 6,752	2
2	400-PP-54/06	400	PP	54/06	Electrowinning Feed Pump (Standby)	MC 200-355	\$ 23,000	4	\$ 11,075	Weir	171	m <sup>3</sup> /h	2	0.00	0	75	m <sup>3</sup> /h	1.1	\$ 6,752	2
2	400-PP-57/59	400	PP	57/59	Electrowinning Discharge Pump (Duty)	MC 200-355	\$ 23,000	4	\$ 11,075	Weir	171	m <sup>3</sup> /h	2	0.75	3	75	m <sup>3</sup> /h	1.1	\$ 6,752	2
2	400-PP-58/60	400	PP	58/60	Electrowinning Discharge Pump (Standby)	MC 200-355	\$ 23,000	4	\$ 11,075	Weir	171	m <sup>3</sup> /h	2	0.00	0	75	m <sup>3</sup> /h	1.1	\$ 6,752	2
2	400-PP-61/63	400	PP	61/63	Cathode Washing Tank Discharge Pump (Duty)	MC 200-355	\$ 6,000	1	\$ 2,868	Weir	18	m <sup>3</sup> /h	0.5	0.75	1	75	m <sup>3</sup> /h	1.1	\$ 6,752	2
2	400-PP-62/64	400	PP	62/64	Cathode Washing Tank Discharge Pump (Standby)	MC 200-355	\$ 6,000	1	\$ 2,868	Weir	18	m <sup>3</sup> /h	0.5	0.00	0	75	m <sup>3</sup> /h	1.1	\$ 6,752	2
2	400-PP-65/67	400	PP	65/67	Stripping Liquor Return Pump (Duty)	MC 200-355	\$ 23,000	4	\$ 11,075	Weir	171	m <sup>3</sup> /h	1.8	0.75	3	75	m <sup>3</sup> /h	1.1	\$ 6,752	2
2	400-PP-66/68	400	PP	66/68	Stripping Liquor Return Pump (Standby)	MC 200-355	\$ 23,000	4	\$ 11,075	Weir	171	m <sup>3</sup> /h	1.8	0.00	0	75	m <sup>3</sup> /h	1.1	\$ 6,752	2
1	400-PP-69	400	PP	69	Crystalliser Feed Pump (Duty)	MC 200-355	\$ 7,000	1	\$ 6,006	Weir	62	m <sup>3</sup> /h	1.0	0.75	1	75	m <sup>3</sup> /h	1.1	\$ 6,752	2
1	400-PP-70	400	PP	70	Crystalliser Feed Pump (Standby)	MC 200-355	\$ 7,000	1	\$ 6,006	Weir	62	m <sup>3</sup> /h	1.0	0.00	0	75	m <sup>3</sup> /h	1.1	\$ 6,752	2
1	400-PP-71	400	PP	71	Stripping Liquor Return Pump (Duty)	MC 200-355	\$ 6,000	1	\$ 5,135	Weir	48	m <sup>3</sup> /h	0.8	0.75	1	75	m <sup>3</sup> /h	1.1	\$ 6,752	2
1	400-PP-72	400	PP	72	Stripping Liquor Return Pump (Standby)	MC 200-355	\$ 6,000	1	\$ 5,135	Weir	48	m <sup>3</sup> /h	0.8	0.00	0	75	m <sup>3</sup> /h	1.1	\$ 6,752	2
1	400-PS-01	400	PS	01	Copper EX Mixer Settler Sump Pump	MC 200-355	\$ 12,000	0	\$ 11,106											4
1	400-PS-02	400	PS	02	Copper Stripping Mixer Settler Sump Pump	MC 200-355	\$ 12,000	0	\$ 11,106											4
1	400-PS-03	400	PS	03	Scrubbing Sump Pump	MC 200-355	\$ 12,000	0	\$ 11,106											4
2	400-PS-04/05	400	PS	04/05	Electrowinning Sump Pump	MC 200-355	\$ 23,000	0	\$ 11,106											4
1	400-PS-06	400	PS	06	Crystalliser Sump Pump	MC 200-355	\$ 12,000	0	\$ 11,106											4
14	400-SH-01-14	400	SH	01-14	Safety Shower and Eyewash Station	MC 200-355	\$ 14,000	0	\$ 1,000											4
1	400-SX-01	400	SX	01	Scrubbing Mixer Settler	settlr, DOP tank, Mixer tank	\$ 1,230,000	53	\$ 1,229,994	Outotec	1158	m <sup>3</sup> /h	53	0.75	40	442	m <sup>3</sup> /h	30	\$ 690,000	2
1	400-SX-02	400	SX	02	Copper Extraction Mixer Settler	settlr, DOP tank, Mixer tank	\$ 4,769,000	130	\$ 4,768,702	Outotec	9267	m <sup>3</sup> /h	130	0.75	98	804	m <sup>3</sup> /h	30	\$ 1,100,000	2
1	400-SX-03	400	SX	03	Copper Extraction Mixer Settler	settlr, DOP tank, Mixer tank	\$ 4,769,000	130	\$ 4,768,702	Outotec	9267	m <sup>3</sup> /h	130	0.75	98	804	m <sup>3</sup> /h	30	\$ 1,100,000	2
1	400-SX-04	400	SX	04	Copper Stripping Mixer Settler	settlr, DOP tank, Mixer tank	\$ 2,925,000	64	\$ 2,924,461	Outotec	4906	m <sup>3</sup> /h	64	0.75	48	442	m <sup>3</sup> /h	15	\$ 690,000	2
1	400-SX-05	400	SX	05	Copper Stripping Mixer Settler	settlr, DOP tank, Mixer tank	\$ 2,925,000	64	\$ 2,924,461	Outotec	4906	m <sup>3</sup> /h	64	0.75	48	442	m <sup>3</sup> /h	15	\$ 690,000	2
1	400-TH-01	400	TH	01	pH Adjustment Thickener	GL13/04 Steel 6.02m D x 4.27m, 122kL	\$ 247,000	0	\$ 245,561	Waterex	6	m				20	m		\$ 499,800	2
1	400-TK-01	400	TK	01	pH Adjustment Tank	GL13/04 Steel 6.02m D x 4.27m, 122kL	\$ 247,000	0	\$ 245,561	Pioneer	388	m <sup>3</sup>				390	m <sup>3</sup>		\$ 250,000	2
1	400-TK-02	400	TK	02	SX PLS Feed Tank	GL13/04 Steel 6.02m D x 4.27m, 122kL	\$ 377,000	0	\$ 376,827	Pioneer	773	m <sup>3</sup>				390	m <sup>3</sup>		\$ 250,000	2
1	400-TK-03	400	TK	03	Organic Control Tank	GL13/04 Steel 6.02m D x 4.27m, 122kL	\$ 47,000	0	\$ 46,694	Pioneer	386	m <sup>3</sup>				122	m <sup>3</sup>		\$ 23,381	2
1	400-TK-04	400	TK	04	Loaded Organic Tank	GL13/04 Steel 6.02m D x 4.27m, 122kL	\$ 47,000	0	\$ 46,692	Pioneer	386	m <sup>3</sup>				122	m <sup>3</sup>		\$ 23,380	2
1	400-TK-05	400	TK	05	Strip Liquor Makeup Tank	GL13/04 Steel 6.02m D x 4.27m, 122kL	\$ 21,000	0	\$ 20,601	Pioneer	23	m <sup>3</sup>				50	m <sup>3</sup>		\$ 33,000	2
1	400-TK-06	400	TK	06	Scrubbing Solution Makeup Tank	GL13/04 Steel 6.02m D x 4.27m, 122kL	\$ 248,000	0	\$ 248,113	Pioneer	386	m <sup>3</sup>				390	m <sup>3</sup>		\$ 250,000	2
1	400-TK-07	400	TK	07	PLS Tank	GL13/04 Steel 6.02m D x 4.27m, 122kL	\$ 248,000	0	\$ 248,113	Pioneer	386	m <sup>3</sup>				390	m <sup>3</sup>		\$ 250,000	2
1	400-TK-08	400	TK	08	SX Waste Tank	GL13/04 Steel 6.02m D x 4.27m, 122kL	\$ 3,000	0	\$ 2,829	Pioneer	1	m <sup>3</sup>				50	m <sup>3</sup>		\$ 33,000	2
1	400-TK-09	400	TK	09	Crud Treatment Tank	GL13/04 Steel 6.02m D x 4.27m, 122kL	\$ 13,000	0	\$ 12,564	Pioneer	10	m <sup>3</sup>				50	m <sup>3</sup>		\$ 33,000	2
1	400-TK-10	400	TK	10	Centrate Collection Tank	GL13/04 Steel 6.02m D x 4.27m, 122kL	\$ 13,000	0	\$ 12,564	Pioneer	10	m <sup>3</sup>				50	m <sup>3</sup>		\$ 33,000	2
2	400-TK-11-12	400	TK	11-12	Cathode Washing Tank	GL13/04 Steel 6.02m D x 4.27m, 122kL	\$ 42,000	0	\$ 40,601	Pioneer	386	m <sup>3</sup>				20	m <sup>3</sup>		\$ 33,000	2
2	400-TK-13-14	400	TK	13-14	Stripping Liquor Tank	GL13/04 Steel 6.02m D x 4.27m, 122kL	\$ 42,000	0	\$ 40,601	Pioneer	23	m <sup>3</sup>				50	m <sup>3</sup>		\$ 33,000	2
2	400-XM-01-02	400	XM	01-02	Cathode Fixing Station		\$ 100,000	0	\$ 50,000											4
2	400-XM-03-04	400	XM	03-04	Cathode Stripping Station		\$ 100,000	0	\$ 80,000											4
2	400-XM-05-06	400	XM	05-06	Cathode Waxing Station		\$ 100,000	0	\$ 50,000											4
2	400-XM-07-08	400	XM	07-08	Cathode Strapping Station		\$ 100,000	0	\$ 80,000											4
2	400-XM-09-10	400	XM	09-10	Cathode Punch Station		\$ 100,000	0	\$ 50,000											4
2	400-XM-11-12	400	XM	11-12	Cathode Weighing Station		\$ 100,000	0	\$ 80,000											4
1	400-YTR-01	400	YTR	01	Foam/CO2 Fire Truck (for SX)		\$ 200,000	0	\$ 200,000											6
1	400-YTR-02	400	YTR	02	Copper Product Flatbed Truck		\$ 120,000	0	\$ 120,000											6
1	500-AG-01	500	AG	01	Precipitation Tank Agitator	5 m dia x 10 m	\$ 49,000	28	\$ 48,833	Motec	311	m <sup>2</sup>	28	0.85	24	354	m <sup>2</sup>	30	\$ 52,799	2
1	500-AG-02	500	AG	02	Iron Tailings Filter Feed Tank Agitator	5 m dia x 10 m	\$ 49,000	28	\$ 48,833	Motec	311	m <sup>2</sup>	28	0.85	24	354	m <sup>2</sup>	30	\$ 52,799	2
2	500-CH-01-02	500	CH	01-02	Filter Press Discharge Chute		\$ 9,000	0	\$ 4,500	Local fabrication										4
1	500-CV-01	500	CV	01	Filter Press Discharge Conveyor	Constructed On Site	\$ 90,000	22	\$ 90,000	Starwest	209	th	22	0.85	19	1	m		\$ 1,900	2
1	500-CV-02	500	CV	02	Tailings Handling Conveyor	600 mm x 50 m x 10 m	\$ 173,000	22	\$ 172,139	Krupp	216	th	22	0.85	19	1750	th		\$ 600,000	2
2	500-FL-01-02	500	FL	01-02	Iron Tailings Filter Press	Rail Mounted Radial Stacker, 600 mm x 50 m x 15 m	\$ 605,000	141	\$ 302,209		89	th	71	0.85	120	50	th	50	\$ 214,286	2
1	500-PP-01	500	PP	01	Precipitation Tank Pump (Duty)	SDB 200/250/Centrifugal	\$ 20,000	54	\$ 19,164	Weir	311	m <sup>3</sup> /h	54	0.75	40	1400	m <sup>3</sup> /h	132	\$ 47,279	2
1	500-PP-02	500	PP	02	Precipitation Tank Pump (Standby)	SDB 200/250/Centrifugal	\$ 20,000	54	\$ 19,164	Weir	311	m <sup>3</sup> /h	54	0.00	0	1400	m <sup>3</sup> /h	132	\$ 47,279	2
1	500-PP-03	500	PP	03	Thickener U/F Pump (Duty)	SDB 200/250/Centrifugal	\$ 17,000	46	\$ 16,439	Weir	241	m <sup>3</sup> /h	46	0.75	34	1400	m <sup>3</sup> /h	132	\$ 47,279	2
1	500-PP-04	500	PP	04	Thickener U/F Pump (Standby)	SDB 200/250/Centrifugal	\$ 17,000	46	\$ 16,439	Weir	241	m <sup>3</sup> /h	46	0.00	0	1400	m <sup>3</sup> /h	132	\$ 47,279	2
1	500-PP-05	500	PP	05	Barren Solution Pond Feed Pump (Duty)	Warman 3zAH	\$ 40,000													

Quantity	Equipment Number	Area Number	Equipment	Tag	Description	Model/Type (equivalent or similar)	Equipment Price (USD)	Estimated Power (kW)	Scaled Cost USD	Supplier	Scaled Capacity	Units	Scaled Power (kW)	Diversity	Diversified Power (kW)	Basis Capacity	Units	Basis Power (kW)	Basis Cost (USD)	Reference		
1	600-PP-04	600	PP	04	Process Water Distribution Pump (Standby)	20x18 pump	\$ 8,000	72	\$ 7,569	Linatex	72	m <sup>3</sup> /h	72	0.00	0	200	m <sup>3</sup> /h	132	\$ 13,973	2		
1	600-PP-05	600	PP	05	Raw Water Transfer Pump (Duty)	Warman 3x2AH	\$ 20,000	189	\$ 19,963	Linatex	362	m <sup>3</sup> /h	189	0.75	141	200	m <sup>3</sup> /h	132	\$ 13,973	2		
1	600-PP-06	600	PP	06	Raw Water Transfer Pump (Standby)	Warman 3x2AH	\$ 20,000	189	\$ 19,963	Linatex	362	m <sup>3</sup> /h	189	0.00	0	200	m <sup>3</sup> /h	132	\$ 13,973	2		
1	600-PP-07	600	PP	07	Process Water Distribution Pump (Duty)	20x18 pump	\$ 8,000	72	\$ 7,569	Linatex	72	m <sup>3</sup> /h	72	0.75	54	200	m <sup>3</sup> /h	132	\$ 13,973	2		
1	600-PP-08	600	PP	08	Process Water Distribution Pump (Standby)	20x18 pump	\$ 8,000	72	\$ 7,569	Linatex	72	m <sup>3</sup> /h	72	0.00	0	200	m <sup>3</sup> /h	132	\$ 13,973	2		
1	600-PP-09	600	PP	09	Diesel Fire Pump	Water Pump	\$ 4,000	11	\$ 3,338	Linatex	35	m <sup>3</sup> /h	11	0.75	8	35	m <sup>3</sup> /h	11	\$ 3,338	4		
1	600-PP-10	600	PP	10	Electric Fire Pump	Water Pump	\$ 4,000	11	\$ 3,338	Linatex	35	m <sup>3</sup> /h	11	0.75	8	35	m <sup>3</sup> /h	11	\$ 3,338	4		
1	600-PP-11	600	PP	11	Jockey Fire Pump	Water Pump	\$ 4,000	11	\$ 3,338	Linatex	35	m <sup>3</sup> /h	11	0.75	8	35	m <sup>3</sup> /h	11	\$ 3,338	4		
1	600-PP-12	600	PP	12	Gland Seal Water Distribution Pump (Duty)		\$ 2,000	5	\$ 1,574		10	m <sup>3</sup> /h	5	0.75	4	35	m <sup>3</sup> /h	11	\$ 3,338	2		
1	600-PP-13	600	PP	13	Gland Seal Water Distribution Pump (Standby)		\$ 2,000	5	\$ 1,574		10	m <sup>3</sup> /h	5	0.00	0	35	m <sup>3</sup> /h	11	\$ 3,338	2		
1	600-PP-14	600	PP	14	Raw Water Distribution Pump (Duty)	Water Pump	\$ 14,000	45	\$ 13,569	Linatex	362	m <sup>3</sup> /h	45	0.75	34	35	m <sup>3</sup> /h	11	\$ 3,338	2		
1	600-PP-15	600	PP	15	Raw Water Distribution Pump (Standby)	Water Pump	\$ 14,000	45	\$ 13,569	Linatex	362	m <sup>3</sup> /h	45	0.00	0	35	m <sup>3</sup> /h	11	\$ 3,338	2		
1	600-TK-01	600	TK	01	Process Water Distribution Tank-Mining Area	Steel Tank with rubber liners, colourbond finish	\$ 78,000	0	\$ 77,383	Pioneer	360	m <sup>3</sup>				2660	m <sup>3</sup>		\$ 256,916	2		
1	600-TK-02	600	TK	02	Raw Water Distribution Tank	Water Tank	\$ 526,000	0	\$ 525,249	Pioneer	8760	m <sup>3</sup>				2660	m <sup>3</sup>		\$ 256,916	4		
1	600-TK-03	600	TK	03	Process Water Distribution Tank-Processing Area	Steel Tank with rubber liners, colourbond finish	\$ 204,000	0	\$ 203,248	Pioneer	1800	m <sup>3</sup>				2660	m <sup>3</sup>		\$ 256,916	2		
1	700-AG-01	700	AG	01	Lime Slurry Distribution Tank Agitator	1.4 m dia x 2.8 m	\$ 2,000	1	\$ 1,937	Mitrac	7	m <sup>3</sup>	1	0.85	1	33	m <sup>3</sup>	2.2	\$ 4,829	2		
1	700-AG-02	700	AG	02	Limestone/Calcrete Slurry Distribution Tank Agitator	3.4 m dia x 6.8 m	\$ 6,000	5	\$ 5,312	Mitrac	24	m <sup>3</sup>	5	0.85	4	86	m <sup>3</sup>	11	\$ 11,423	2		
1	700-AG-03	700	AG	03	LIX Mixing Tank Agitator	1 m dia x 2 m	\$ 2,000	1	\$ 1,937	Mitrac	7.2	m <sup>3</sup>	0.9	0.85	1	33	m <sup>3</sup>	2.2	\$ 4,829	2		
1	700-BN-01	700	BN	01	Quicklime Feed Silo		\$ 181,000		\$ 180,467	Local Fabrication	58	m <sup>3</sup>				100	m <sup>3</sup>		\$ 251,273	2		
1	700-BN-02	700	BN	02	Limestone/Calcrete Feed Silo		\$ 192,000		\$ 191,522	Local Fabrication	64	m <sup>3</sup>				100	m <sup>3</sup>		\$ 251,273	2		
1	700-FE-01	700	FE	01	Quicklime Feeder	Belt Feeder	\$ 5,000	2	\$ 4,944	Melso	2.1	t/hr	2	0.75	2	320	t/hr	10	\$ 100,500	3		
1	700-FE-02	700	FE	02	Limestone/Calcrete Feeder	Belt Feeder	\$ 10,000	1	\$ 9,881	Melso	6.8	t/hr	1	0.75	1	320	t/hr	10	\$ 100,500	2		
1	700-MH-01	700	MH	01	Bulk Bag Monorail and Hold		\$ 18,000	0	\$ 18,000	Elbeck Cranes												
1	700-ME-01	700	ME	01	Forklift		\$ 30,000	0	\$ 30,000													
1	700-ME-02	700	ME	02	Crane		\$ 150,000	0	\$ 150,000													
1	700-ME-03	700	ME	03	Crane		\$ 150,000	0	\$ 150,000													
1	700-PK-01	700	PK	01	Lime Slaking Mill		\$ 450,000	0	\$ 450,000													
1	700-PK-02	700	PK	02	Guar Gum Vendor Package		\$ 250,000	0	\$ 250,000													
1	700-PK-03	700	PK	03	Cobalt Sulphate Vendor Package		\$ 50,000	0	\$ 50,000													
1	700-PK-04	700	PK	04	Polyacrylamide Vendor Package		\$ 250,000	0	\$ 250,000													
1	700-PK-05	700	PK	05	Flocculant Vendor Package		\$ 114,000	3	\$ 113,145	Transmin	18.15	kg/hr	3	0.50	2	218	kg/hr	15	\$ 502,785	2		
1	700-PP-01	700	PP	01	Lime Transfer Pump (Duty)		\$ 4,000	1	\$ 4,000	Allied Colloids	2.1	m <sup>3</sup> /h	0.1	0.75	0	75	m <sup>3</sup> /h	1.1	\$ 6,752	2		
1	700-PP-02	700	PP	02	Lime Transfer Pump (Standby)		\$ 4,000	1	\$ 4,000	Allied Colloids	2.1	m <sup>3</sup> /h	0.1	0.00	0	75	m <sup>3</sup> /h	1.1	\$ 6,752	2		
1	700-PP-03	700	PP	03	Lime Metering Pump (Duty)		\$ 4,000	1	\$ 4,000	Allied Colloids	2.1	m <sup>3</sup> /h	0.1	0.75	0	75	m <sup>3</sup> /h	1.1	\$ 6,752	2		
1	700-PP-04	700	PP	04	Lime Metering Pump (Standby)		\$ 4,000	1	\$ 4,000	Allied Colloids	2.1	m <sup>3</sup> /h	0.1	0.00	0	75	m <sup>3</sup> /h	1.1	\$ 6,752	2		
1	700-PP-05	700	PP	05	Lime Metering Pump (Duty)		\$ 4,000	1	\$ 4,000	Allied Colloids	2.1	m <sup>3</sup> /h	0.13	0.75	0	75	m <sup>3</sup> /h	1.1	\$ 6,752	2		
1	700-PP-06	700	PP	06	Lime Metering Pump (Standby)		\$ 4,000	1	\$ 4,000	Allied Colloids	2.1	m <sup>3</sup> /h	0.13	0.00	0	75	m <sup>3</sup> /h	1.1	\$ 6,752	2		
1	700-PP-07	700	PP	07	Lime Metering Pump (Duty)		\$ 4,000	1	\$ 4,000	Allied Colloids	2.1	m <sup>3</sup> /h	0.1	0.75	0	75	m <sup>3</sup> /h	1.1	\$ 6,752	2		
1	700-PP-08	700	PP	08	Lime Metering Pump (Standby)		\$ 4,000	1	\$ 4,000	Allied Colloids	2.1	m <sup>3</sup> /h	0.1	0.00	0	75	m <sup>3</sup> /h	1.1	\$ 6,752	2		
1	700-PP-09	700	PP	09	Limestone Metering Pump (Duty)		\$ 14,000	1	\$ 14,000	Allied Colloids	6.8	m <sup>3</sup> /h	0.3	0.75	0	75	m <sup>3</sup> /h	1.1	\$ 6,752	2		
1	700-PP-10	700	PP	10	Limestone Metering Pump (Standby)		\$ 14,000	1	\$ 14,000	Allied Colloids	6.8	m <sup>3</sup> /h	0.3	0.00	0	75	m <sup>3</sup> /h	1.1	\$ 6,752	2		
1	700-PP-11	700	PP	11	Limestone Metering Pump (Duty)		\$ 14,000	1	\$ 14,000	Allied Colloids	6.8	m <sup>3</sup> /h	0.27	0.75	0	75	m <sup>3</sup> /h	1.1	\$ 6,752	2		
1	700-PP-12	700	PP	12	Limestone Metering Pump (Standby)		\$ 14,000	1	\$ 14,000	Allied Colloids	6.8	m <sup>3</sup> /h	0.27	0.00	0	75	m <sup>3</sup> /h	1.1	\$ 6,752	2		
1	700-PP-13	700	PP	13	Limestone Metering Pump (Duty)		\$ 14,000	1	\$ 14,000	Allied Colloids	6.8	m <sup>3</sup> /h	0.3	0.75	0	75	m <sup>3</sup> /h	1.1	\$ 6,752	2		
1	700-PP-14	700	PP	14	Limestone Metering Pump (Standby)		\$ 14,000	1	\$ 14,000	Allied Colloids	6.8	m <sup>3</sup> /h	0.3	0.00	0	75	m <sup>3</sup> /h	1.1	\$ 6,752	2		
1	700-PP-15	700	PP	15	Acid Metering Pump (Duty)		\$ 45,000	8	\$ 44,975		3.2	m <sup>3</sup> /h	8	0.75	6	0.037	m <sup>3</sup> /h	0.55	\$ 3,111	2		
1	700-PP-16	700	PP	16	Acid Metering Pump (Standby)		\$ 45,000	8	\$ 44,975		3.2	m <sup>3</sup> /h	8	0.00	0	0.037	m <sup>3</sup> /h	0.55	\$ 3,111	2		
1	700-PP-17	700	PP	17	Acid Metering Pump (Duty)		\$ 45,000	8	\$ 44,975		3.2	m <sup>3</sup> /h	8	0.75	6	0.037	m <sup>3</sup> /h	0.55	\$ 3,111	2		
1	700-PP-18	700	PP	18	Acid Metering Pump (Standby)		\$ 45,000	8	\$ 44,975		3.2	m <sup>3</sup> /h	8	0.00	0	0.037	m <sup>3</sup> /h	0.55	\$ 3,111	2		
1	700-PP-19	700	PP	19	Acid Metering Pump (Duty)		\$ 45,000	8	\$ 44,975		3.2	m <sup>3</sup> /h	7.96	0.75	6	0.037	m <sup>3</sup> /h	0.55	\$ 3,111	2		
1	700-PP-20	700	PP	20	Acid Metering Pump (Standby)		\$ 45,000	8	\$ 44,975		3.2	m <sup>3</sup> /h	7.96	0.00	0	0.037	m <sup>3</sup> /h	0.55	\$ 3,111	2		
1	700-PP-21	700	PP	21	Acid Metering Pump (Duty)		\$ 45,000	8	\$ 44,975		3.2	m <sup>3</sup> /h	8	0.75	6	0.037	m <sup>3</sup> /h	0.55	\$ 3,111	2		
1	700-PP-22	700	PP	22	Acid Metering Pump (Standby)		\$ 45,000	8	\$ 44,975		3.2	m <sup>3</sup> /h	8	0.00	0	0.037	m <sup>3</sup> /h	0.55	\$ 3,111	2		
1	700-PP-23	700	PP	23	LIX Transfer Pump (Duty)		\$ 8,800	1	\$ 8,800	Allied Colloids	70	L	1.0	0.75	1							
1	700-PP-24	700	PP	24	LIX Transfer Pump (Standby)		\$ 8,800	1	\$ 8,800	Allied Colloids	70	L	1.0	0.00	0							
1	700-PP-25	700	PP	25	LIX Metering Pump (Duty)		\$ 8,800	1	\$ 8,800	Allied Colloids	70	L	1.0	0.75	1							
1	700-PP-26	700	PP	26	LIX Metering Pump (Standby)		\$ 8,800	1	\$ 8,800	Allied Colloids	70	L	1.0	0.00	0							
1	700-PP-27	700	PP	27	Kerosene Metering Pump (Duty)	Mono B021 in 316 S.S.	\$ 13,000	1	\$ 13,000	Challenge	473	L	1.0	0.75	1							
1	700-PP-28	700	PP	28	Kerosene Metering Pump (Standby)	Mono B021 in 316 S.S.	\$ 13,000	1	\$ 13,000	Challenge	473	L	1.0	0.00	0							
1	700-PP-29	700	PP	29	Kerosene Metering Pump (Duty)	Mono B021 in 316 S.S.	\$ 13,000	1	\$ 13,000	Challenge	473	L	1.0	0.75	1							
1	700-PP-30	700	PP	30	Kerosene Metering Pump (Standby)	Mono B021 in 316 S.S.	\$ 13,000	1	\$ 13,000	Challenge	473	L	1.0	0.00	0							
1	700-PS-01	700	PS	01	Lime Sump Pump		\$ 12,000	0	\$ 11,106													
1	700-PS-02	700	PS	02	Limestone Sump Pump		\$ 12,000	0	\$ 11,106													
1	700-PS-03	700	PS	03	Acid Sump Pump		\$ 12,000	0	\$ 11,106													
1	700-PS-04	700	PS	04	LIX Sump Pump		\$ 12,000	0	\$ 11,106													
1	700-PS-05	700	PS	05	Guar Gum Sump Pump		\$ 12,000	0	\$ 11,106													
1	700-PS-06	700	PS	06	Cobalt Sulphate Sump Pump		\$ 12,000	0	\$ 11,106													
1	700-PS-07	700	PS	07	Kerosene Sump Pump		\$ 12,000	0	\$ 11,106													
1	700-PS-08	700	PS	08	Polyacrylamide Sump Pump		\$ 12,000	0	\$ 11,106													
1	700-SH-09	700	SH	09	Flocculant Sump Pump		\$ 12,000	0	\$ 11,106													

Quantity	Equipment Number	Area Number	Equipment	Tag	Description	Model/Type (equivalent or similar)	Equipment Price (USD)	Estimated Power (kW)	Scaled Cost USD	Supplier	Scaled Capacity	Units	Scaled Power (kW)	Diversity	Diversified Power (kW)	Basis Capacity	Units	Basis Power (kW)	Basis Cost (USD)	Reference		
1	800-HX-04	800	HX	04	Safety Shower Water Tank Chiller	SX Feed Intercooler-MBMFG	\$ 5,000	0	\$ 4,235	Aifa Laval										4		
1	800-PK-01	800	PK	01	RO Plant Vendor Package		\$ 272,000	33	\$ 271,656		3	m³/h	33	0.85	28	2.5	m³/h	30	\$ 243,506	4		
1	800-PP-01	800	PP	01	Potable Water Distribution Pump (Duty)		\$ 5,000	1	\$ 4,235											4		
1	800-PP-02	800	PP	02	Potable Water Distribution Pump (Standby)		\$ 5,000	1	\$ 4,235											4		
1	800-PP-03	800	PP	03	Potable Water Distribution Pump (Duty)-Mining Area		\$ 5,000	1	\$ 4,235											4		
1	800-PP-04	800	PP	04	Potable Water Distribution Pump (Standby)-Mining Area		\$ 5,000	1	\$ 4,235											4		
1	800-PP-05	800	PP	05	Safety Shower Water Tank Recirculation Pump-Mining Area		\$ 5,000	1	\$ 4,235											4		
1	800-PP-06	800	PP	06	Safety Shower Pump (Duty)-Mining Area		\$ 3,000	1	\$ 2,503											4		
1	800-PP-07	800	PP	07	Safety Shower Pump (Standby)-Mining Area		\$ 3,000	1	\$ 2,503											4		
1	800-PP-08	800	PP	08	Safety Shower Water Tank Recirculation Pump		\$ 5,000	1	\$ 4,235											4		
1	800-PP-09	800	PP	09	Safety Shower Pump (Duty)		\$ 3,000	1	\$ 2,503											4		
1	800-PP-10	800	PP	10	Safety Shower Pump (Standby)		\$ 3,000	1	\$ 2,503											4		
1	800-PP-11	800	PP	11	Fast Fill Bowser - Light Vehicle Pump		\$ 7,000	1	\$ 6,545											4		
1	800-PP-12	800	PP	12	Fast Fill Bowser - Mobile Equipment Plant Pump		\$ 7,000	1	\$ 6,930											4		
1	800-PP-13	800	PP	13	Diesel Distribution Pump (Duty)		\$ 2,000	1	\$ 1,386											4		
1	800-PP-14	800	PP	14	Diesel Distribution Pump (Standby)		\$ 2,000	1	\$ 1,386											4		
1	800-PP-15	800	PP	15	Cooling Water Pump (Duty)		\$ 5,000	1	\$ 4,235											4		
1	800-PP-16	800	PP	16	Cooling Water Pump (Standby)		\$ 5,000	1	\$ 4,235											4		
1	800-PP-17	800	PP	17	Cooling Water Distribution Pump (Duty)		\$ 5,000	1	\$ 4,235											4		
1	800-PP-18	800	PP	18	Cooling Water Distribution Pump (Standby)		\$ 5,000	1	\$ 4,235											4		
1	800-PP-19	800	PP	19	Heating Water Pump (Duty)		\$ 5,000	1	\$ 4,235											4		
1	800-PP-20	800	PP	20	Heating Water Pump (Standby)		\$ 5,000	1	\$ 4,235											4		
1	800-RA-01	800	RA	01	Air Receiver		\$ 18,000	0	\$ 17,715	S&L Engineering										4		
1	800-RA-02	800	RA	02	Instrument Air Receiver		\$ 18,000	0	\$ 17,715	S&L Engineering											4	
1	800-TK-01	800	TK	01	Plant Potable Water Tank		\$ 37,000	0	\$ 36,960											4		
1	800-TK-02	800	TK	02	Plant Potable Water Tank-Mining Area		\$ 37,000	0	\$ 36,960											4		
1	800-TK-03	800	TK	03	Safety Shower Water Tank-Mining Area		\$ 37,000	0	\$ 36,960											4		
1	800-TK-04	800	TK	04	Safety Shower Water Tank		\$ 37,000	0	\$ 36,960											4		
1	800-TK-05	800	TK	05	Diesel Storage Tank		\$ 501,000	0	\$ 500,500											4		
1	800-TK-06	800	TK	06	Cooling Water Recycle Tank		\$ 37,000	0	\$ 36,960											4		
1	800-TK-07	800	TK	07	Cooling Water Storage Tank		\$ 37,000	0	\$ 36,960											4		
1	800-TK-08	800	TK	08	Heating Water Recycle Tank		\$ 37,000	0	\$ 36,960											4		
1	0-ME-01	0	ME	01	Workshop Forklift		\$ 35,000	0	\$ 35,000											\$ 17,250	6	
1	0-ME-02	0	ME	02	Stores Forklift		\$ 35,000	0	\$ 35,000												\$ 17,250	6
1	0-ME-03	0	ME	03	General/Maintenance Light Vehicles		\$ 35,000	0	\$ 35,000												\$ 14,250	6
1	0-ME-04	0	ME	04	General/Maintenance Light Vehicles		\$ 35,000	0	\$ 35,000												\$ 14,250	6
1	0-ME-05	0	ME	05	General/Maintenance Light Vehicles		\$ 35,000	0	\$ 35,000												\$ 14,250	6
1	0-ME-06	0	ME	06	General/Maintenance Light Vehicles		\$ 35,000	0	\$ 35,000												\$ 14,250	6
1	0-ME-07	0	ME	07	Mobile Lighting Tower		\$ 21,000	0	\$ 20,405												\$ 15,000	6
1	0-ME-08	0	ME	08	Mobile Lighting Tower		\$ 21,000	0	\$ 20,405												\$ 15,000	6
1	0-ME-09	0	ME	09	Mobile Lighting Tower		\$ 21,000	0	\$ 20,405												\$ 15,000	6
1	0-ME-10	0	ME	10	Ambulance		\$ 90,000	0	\$ 90,000												\$ 29,250	6
1	0-ME-11	0	ME	11	Cherry Picker		\$ 116,000	0	\$ 115,500												\$ 87,000	6
1	0-ME-12	0	ME	12	Hoist		\$ 15,000	0	\$ 15,000												\$ 6,000	6
1	0-SHD-01	0	SHD	01	Office/Carleen	16x25x4 (w x l x h)	\$ 80,000	0	\$ 80,000												\$ 80,000	6
1	0-SHD-02	0	SHD	02	Security Gate House	12x33x4 (w x l x h)	\$ 80,000	0	\$ 80,000												\$ 80,000	6
1	0-SHD-03	0	SHD	03	Assay Laboratory	8x8x4 (w x l x h)	\$ 56,000	0	\$ 56,000												\$ 56,000	6
1	0-SHD-04	0	SHD	04	Metallurgical Laboratory	12x33x4 (w x l x h)	\$ 80,000	0	\$ 80,000												\$ 80,000	6
1	0-SHD-05	0	SHD	05	Stores	12x32x6 (w x l x h)	\$ 80,000	0	\$ 80,000												\$ 80,000	6
1	0-SHD-06	0	SHD	06	Workshop	12x32x6 (w x l x h)	\$ 80,000	0	\$ 80,000												\$ 80,000	6
1	0-SHD-07	0	SHD	07	Control Room	8x8x4 (w x l x h)	\$ 56,000	0	\$ 56,000												\$ 56,000	6
1	0-SHD-08	0	SHD	08	Admin Office	8x8x4 (w x l x h)	\$ 56,000	0	\$ 56,000												\$ 56,000	6
1	0-SHD-09	0	SHD	09	Medical Centre	8x8x4 (w x l x h)	\$ 56,000	0	\$ 56,000												\$ 56,000	6
1	0-YTD-01	0	YTD	01	Security Vehicle (4WD)		\$ 54,000	0	\$ 53,900												\$ 40,500	6
1	0-YTD-02	0	YTD	02	Security Vehicle (4WD)		\$ 54,000	0	\$ 53,900												\$ 40,500	6
1	0-YTR-01	0	YTR	01	Water Truck		\$ 193,000	0	\$ 192,500												\$ 144,750	6

Client  
Deep South Resources

Project  
Haib Leach Project - 20 Mtpa @ 85% Cu Recovery

Document Number  
J5459-CAL-000-001

Quantity	Equipment Number	Area Number	Equipment	Tag	Description	Model/Type (equivalent or similar)	Equipment Price (USD)	Estimated Power (kW)	Scaled Cost USD	Supplier	Scaled Capacity	Units	Scaled Power (kW)	Diversity	Diversified Power (kW)	Basis Capacity	Units	Basis Power (kW)	Basis Cost (USD)	Reference	
1	100-BN-01	100	BN	01	ROM Bin		\$ 197,000		\$ 196,940	Local Fabrication	349	m <sup>3</sup>				236	m <sup>3</sup>		\$ 151,623	2	
5	100-BN-02-06	100	BN	02-06	Cone Crusher Feed Bin		\$ 996,000		\$ 999,145	Local Fabrication	356	m <sup>3</sup>				74	m <sup>3</sup>		\$ 77,596	2	
3	100-BN-07-09	100	BN	07-09	Screen Feed Bin		\$ 812,000		\$ 270,570	Local Fabrication	593	m <sup>3</sup>				74	m <sup>3</sup>		\$ 77,596	2	
1	100-CR-01	100	CR	01	Gratory Crusher	CG630	\$ 4,536,000	660	\$ 4,536,000	Sandvik	3914	t/h	660	0.66	436						6
5	100-CR-02-06	100	CR	02-06	Cone Crusher	CH870-03	\$ 5,231,000	3000	\$ 1,046,139	Sandvik	1282	t/h	600	0.84	2534						6
1	100-CV-01	100	CV	01	Primary Crusher Discharge Conveyor	1200mm x 150 m x 25 m	\$ 330,000	550	\$ 330,000	Sanwest	6408	t/h	550	0.85	468	1	m		\$ 2,200	2	
5	100-CV-02-06	100	CV	02-06	Cone Crusher Feed Conveyor	1200mm x 100 m x 25 m	\$ 135,000	55	\$ 27,000	Sanwest	1282	t/h	11	0.85	47	1	m		\$ 1,800	2	
1	100-CV-07	100	CV	07	Cone Crusher Discharge Conveyor	1200mm x 100 m x 25 m	\$ 220,000	550	\$ 220,000	Sanwest	6408	t/h	550	0.85	468	1	m		\$ 2,200	2	
1	100-CV-08	100	CV	08	Screen U/S Discharge Conveyor	1200mm x 75 m x 10 m	\$ 165,000	350	\$ 165,000	Sanwest	3914	t/h	350	0.85	298	1	m		\$ 2,200	2	
2	100-CV-09-10	100	CV	09-10	Crushed Ore Discharge Conveyor	1200 mm x 20 m	\$ 72,000	22	\$ 36,000	Sanwest	1957	t/h	11	0.85	19	1	m		\$ 1,800	2	
1	100-TP-01	100	TP	01	Crushed Product Conveyor	1200 mm x 4500 m x 30 m	\$ 9,900,000	2020	\$ 9,900,000	Sanwest	3914	t/h	2020	0.85	1717						2
1	100-FE-01	100	FE	01	Primary Crusher Discharge Apron Feeder	Apron Feeder - 1219mm x 6000mm	\$ 532,000	275	\$ 531,899	Sanwest	3914	t/h	275	0.85	233	450	t/h	39	\$ 75,040	2	
5	100-FE-02-08	100	FE	02-08	Cone Crusher Vibrating Feeder		\$ 508,000	202	\$ 191,085	Sanwest	1282	t/h	40	0.85	172	780	t/h	10	\$ 74,000	2	
3	100-FE-07-09	100	FE	07-09	Crushed Product Screen Feeders	1200 mm x 15 m	\$ 694,000	94	\$ 231,155	Sanwest	2136	t/h	31	0.75	216	320	t/h	10	\$ 74,000	2	
2	100-FE-10-11	100	FE	10-11	Crushed Ore Stockpile Apron Feeder	Apron Feeder - 1219mm x 6000mm	\$ 702,000	362	\$ 350,922	Sanwest	1957	t/h	181	0.85	308	450	t/h	75	\$ 145,275	2	
6	100-MD-01-06	100	MD	01-06	Metal Detector		\$ 138,000	0	\$ 23,000											4	
1	100-MG-01	100	MG	01	Tramp Metal Magnet		\$ 50,000	0	\$ 50,000											4	
1	100-RB-01	100	RB	01	Mobile Rock Breaker		\$ 88,000	0	\$ 87,150											4	
3	100-SC-01-03	100	SC	01-03	Crusher Product Screen	Metso TSS 2 Double-Deck Banana	\$ 1,548,000	198	\$ 515,914	Metso	20	m <sup>2</sup>	66	0.85	168	26	m <sup>2</sup>		\$ 600,000	2	
1	100-SH-01	100	SH	01	Primary Crusher Area Safety Shower and Eyewash Station		\$ 4,000	0	\$ 4,000											4	
1	100-SH-02	100	SH	02	Screening Area Safety Shower and Eyewash Station		\$ 4,000	0	\$ 4,000											4	
1	100-SH-03	100	SH	03	Cone Crusher Safety Shower and Eyewash Station		\$ 4,000	0	\$ 4,000											4	
1	100-SV-01	100	SV	01	Surge Vault		\$ 294,000	0	\$ 293,999	Local Fabrication	725	m <sup>3</sup>				300	m <sup>3</sup>		\$ 173,000	2	
1	100-TP-02	100	TP	02	Screen Feed Tripper Conveyor		\$ 2,200,000	80	\$ 2,200,000		1282	t/h	80	0.85	68					4	
1	100-WS-01-04	100	WS	01-04	Water Sprayer		\$ 50,000	0	\$ 50,000		6408	t/h	80	0.85	68					4	
10	100-WT-01-10	100	WT	01-10	Weightmeter		\$ 325,000	0	\$ 32,500											4	
1	100-SHD-01	100	SHD	01	Crusher Control Room		\$ 25,000	0	\$ 24,283											4	
1	100-YFL-01	100	YFL	01	Front End Loader		\$ 500,000	0	\$ 500,000											4	
1	100-SP-01	100	SP	01	Crushed Product Stockpile		\$ 1,354,000	0	\$ 1,353,123		46967	t				62100			\$ 1,600,000	4	
1	200-SP-01	200	SP	01	HPGR Feed Stockpile		\$ 2,674,000	0	\$ 2,674,540		146119	t				62100			\$ 1,600,000	4	
2	200-BN-01-02	200	BN	01-02	HPGR Feed Bin		\$ 517,000		\$ 258,432		550	m <sup>3</sup>				74	m <sup>3</sup>		\$ 77,596	2	
4	200-BN-03-06	200	BN	03-06	Screen Feed Bin		\$ 683,000		\$ 170,511	Local Fabrication	275	m <sup>3</sup>				74	m <sup>3</sup>		\$ 77,596	2	
2	200-CV-01-02	200	CV	01-02	Stockpile Discharge Conveyor	1200 mm x 20 m	\$ 72,000	22	\$ 36,000	Sanwest	1522	t/h	11	0.85	19	1	m		\$ 1,800	2	
1	200-CV-03	200	CV	03	HPGR Feed Conveyor	1200mm x 150 m x 25 m	\$ 330,000	350	\$ 330,000	Sanwest	3957	t/h	350	0.85	298	1	m		\$ 2,200	2	
2	200-CV-04-05	200	CV	04-05	HPGR Feed Conveyors	1200 mm x 15 m	\$ 54,000	22	\$ 27,000	Sanwest	1979	t/h	11	0.85	19	1	m		\$ 1,800	2	
1	200-CV-06	200	CV	06	Screen Feed Conveyor	1200mm x 100 m x 25 m	\$ 180,000	300	\$ 180,000	Sanwest	3044	t/h	300	0.85	255	1	m		\$ 1,800	2	
1	200-CV-07	200	CV	07	Screen Discharge Conveyor	1200 mm x 75 m x 10 m	\$ 150,000	120	\$ 150,000	Sanwest	3044	t/h	120	0.85	102	1	m		\$ 2,000	2	
2	200-FE-01-02	200	FE	01-02	HPGR Stockpile Apron Feeder		\$ 604,000	312	\$ 301,803	Sanwest	1522	t/h	156	0.85	265	450	t/h	75	\$ 145,275	2	
2	200-FE-03-04	200	FE	03-04	HPGR Vibrating Feeder		\$ 283,000	105	\$ 131,179	Sanwest	1979	t/h	52	0.85	89	780	t/h	30	\$ 75,040	2	
4	200-FE-05-08	200	FE	05-08	Screen Vibrating Feeder		\$ 347,000	138	\$ 86,546	Sanwest	989	t/h	35	0.85	118	780	t/h	30	\$ 75,040	2	
2	200-GR-01-02	200	GR	01-02	HPGR	HPGR 630176-0WH-1230-PG1E	\$ 13,595,000	9600	\$ 6,797,084	Koepvern	1979	t/h	4800	0.75	7245					2	
2	200-MD-01-02	200	MD	01-02	Metal Detector		\$ 46,000	0	\$ 23,000											4	
4	200-SC-01-04	200	SC	01-04	HPGR Screens	Metso T86 2 Double-Deck Banana	\$ 2,064,000	264	\$ 515,914	Metso	20	m <sup>2</sup>	66	0.75	198	26	m <sup>2</sup>		\$ 600,000	2	
1	200-SH-01	200	SH	01	Grinding Area Safety Shower and Eyewash Station		\$ 4,000	0	\$ 4,000											4	
1	200-SH-02	200	SH	02	Screen Area Safety Shower and Eyewash Station		\$ 4,000	0	\$ 4,000											4	
1	200-TP-01	200	TP	01	Screen Feed Tripper Conveyor		\$ 2,200,000	80	\$ 2,200,000											4	
1	200-WS-01-03	200	WS	01-03	Water Sprays		\$ 50,000	0	\$ 50,000											4	
6	200-WT-01-06	200	WT	01-06	Weightmeter		\$ 195,000	0	\$ 32,500											4	
1	200-YFL-01	200	YFL	01	Front End Loader		\$ 500,000	0	\$ 500,000											4	
4	300-AD-01-04	300	AD	01-04	Agglomerator Drum	3610	\$ 5,400,000	960	\$ 1,350,000	Sepro Sylems	400	m <sup>3</sup>	240	0.75	720					2	
1	300-BN-01	300	BN	01	Agglomerator Feed Bin		\$ 198,000		\$ 197,511	Local Fabrication	352	m <sup>3</sup>				74	m <sup>3</sup>		\$ 77,596	2	
1	300-CH-01	300	CH	01	Filter Press Discharge Chute	Constructed On Site	\$ 5,000	0	\$ 4,500	Local Fabrication										4	
1	300-CV-01	300	CV	01	Agglomerator Feed Conveyor	1200 mm x 75 m x 25 m	\$ 165,000	125	\$ 165,000	Krupp	3044	t/h	125	0.85	106	1	m		\$ 2,200	2	
2	300-CV-02-03	300	CV	02-03	Agglomerator Feed Conveyors	1200 mm x 75 m x 25 m	\$ 330,000	22	\$ 165,000	Krupp	1522	t/h	11	0.85	19	1	m		\$ 2,200	2	
1	300-CV-04	300	CV	04	Agglomerator Product Conveyor	1200 mm x 150 m x 50 m	\$ 330,000	300	\$ 330,000	Krupp	3356	t/h	300	0.85	255	1	m		\$ 2,200	2	
6	300-CV-05-09	300	CV	05-09	Grasshopper Conveyors	1200 mm x 50 m x 2.5 m	\$ 600,000	240	\$ 100,000	Sanwest	3356	t/h	40	0.85	204	1	m		\$ 2,000	2	
1	300-CV-10	300	CV	10	Radial Stacker for Primary Leach Heap	Roll Mounted Radial Stacker. 1200 mm x 50 m x 15 m	\$ 887,000	100	\$ 886,788	Krupp	3356	t/h	100	0.85	85	1750	t/h		\$ 600,000	2	
1	300-CV-11	300	CV	11	Neutralised Tailings Transfer Conveyor	800 mm x 20 m x 5 m	\$ 36,000	21	\$ 36,000	Sanwest	9	t/h	21	0.85	18	1	m		\$ 1,800	2	
1	300-FE-01	300	FE	01	Belt Feeder	Belt Feeder	\$ 389,000	39	\$ 388,289	Metso	3044	t/h	39	0.85	33	320	t/h	10	\$ 100,500	2	
1	300-IR-01	300	IR	01	Primary Heap Leach Drip Irrigation		\$ 117,000	0	\$ 117,000		120000	m				1	m <sup>3</sup>		\$ 1	2	
1	300-IR-02	300	IR	02	Secondary Heap Leach Drip Irrigation		\$ 117,000	0	\$ 117,000		120000	m				1	t/h		\$ 1	2	
1	300-IR-03	300	IR	03	Wash Heap Leach Drip Irrigation		\$ 117,000	0	\$ 117,000		120000	m				1	t/h		\$ 1	2	
1	300-PD-01	300	PD	01	Barren Pond		\$ 2,865,000	0	\$ 2,864,160		110160	m <sup>3</sup>				1	m <sup>2</sup>		\$ 26	3	
1	300-PD-02	300	PD	02	LS Pond		\$ 2,865,000	0	\$ 2,864,160		110160	m <sup>3</sup>				1	m <sup>2</sup>		\$ 26	3	
1	300-PD-03	300	PD	03	Active Solution Pond		\$ 2,865,000	0	\$ 2,864,160		110160	m <sup>3</sup>				1	m <sup>2</sup>		\$ 26	3	
1	300-PP-01	300	PP	01	pH Adjustment Thickener Feed Pump (Duty)		\$ 87,000	241	\$ 86,375		3822	m <sup>3</sup> /h	241	0.75	181	1400	m <sup>3</sup> /h	132	\$ 47,279	2	
1	300-PP-02	300	PP	02	pH Adjustment Thickener Feed Pump (Standby)		\$ 87,000	241	\$ 86,375		3822	m <sup>3</sup> /h	241	0.00	0	1400	m <sup>3</sup> /h	132	\$ 47,279	2	
1	300-PP-03	300	PP	03	pH Adjustment Filter Press Feed Pump (Duty)		\$ 87,000	241	\$ 86,375		3822	m <sup>3</sup> /h	241	0.75	181	1400	m <sup>3</sup> /h	132	\$ 47,279	2	
1	300-PP-04	300	PP	04	pH Adjustment Filter Press Feed Pump (Standby)		\$ 87,000	241	\$ 86,375		3822	m <sup>3</sup> /h	241	0.00	0	1400	m <sup>3</sup> /h	132	\$ 47,279	2	
1	300-PP-05	300	PP	05	pH Adjustment Filtrate Pump (Duty)		\$ 87,000	241	\$ 86,375		3822	m <sup>3</sup> /h	241	0.75	181	1400	m <sup>3</sup> /h	132	\$ 47,279	2	
1	300-PP-06	300	PP	06	pH Adjustment Filtrate Pump (Standby)		\$ 87,000														

Quantity	Equipment Number	Area Number	Equipment	Tag	Description	Model/Type (equivalent or similar)	Equipment Price (USD)	Estimated Power (kW)	Scaled Cost USD	Supplier	Scaled Capacity	Units	Scaled Power (kW)	Diversity	Diversified Power (kW)	Basis Capacity	Units	Basis Power (kW)	Basis Cost (USD)	Reference
1	300-PP-16	300	PP	16	Cu SX Feed Pump (Standby)	SDB 200/250/Centrifugal	\$ 97,000	271	\$ 96,998		4638	m <sup>3</sup> h	271	0.00	0	1400	m <sup>3</sup> h	132	\$ 47,279	2
3	300-SH-01-03	300	SH	01-03	Safety Shower and Eye Wash Station		\$ 12,000	0	\$ 4,000											4
1	300-YFL-01	300	YFL	01	Front End Loader		\$ 500,000	0	\$ 500,000											4
1	300-HX-01	300	HX	01	Pipe Heat Exchanger		\$ 1,300,000	0	\$ 1,299,604		129960	m <sup>2</sup>								4
1	300-HX-02	300	HX	02	Pipe Heat Exchanger		\$ 1,560,000	0	\$ 1,559,525		155953	m <sup>2</sup>								4
1	300-HX-03	300	HX	03	Pipe Heat Exchanger		\$ 2,080,000	0	\$ 2,079,367		207937	m <sup>2</sup>								4
1	300-TK-01	300	TK	01	pH Adjustment Tank		\$ 294,000	0	\$ 293,538	Pioneer	510	m <sup>3</sup>				390	m <sup>3</sup>		\$ 250,000	2
1	300-AG-01	300	AG	01	pH Adjustment Tank Agitator	5 m dia x 10 m	\$ 56,000	32	\$ 55,751	Lightnin	388	m <sup>3</sup>	32	0.85	27	354	m <sup>3</sup>	30	\$ 52,799	2
1	300-TH-01	300	TH	01	pH Adjustment Thickener		\$ 300,000	0	\$ 299,420	Waterlex	9	m <sup>2</sup>				20	m <sup>2</sup>		\$ 499,800	2
1	300-FL-01	300	FL	01	pH Adjustment Filter Press		\$ 71,000	17	\$ 70,871		8	t <sup>hr</sup>	17	0.85	14	90	t <sup>hr</sup>	50	\$ 214,286	2
1	400-AG-01	400	AG	01	pH Adjustment Tank Agitator	5 m dia x 10 m	\$ 56,000	32	\$ 55,751	Lightnin	388	m <sup>3</sup>	32	0.85	27	354	m <sup>3</sup>	30	\$ 52,799	2
1	400-AG-02	400	AG	02	Organic Control Tank Agitator	5 m dia x 10 m	\$ 56,000	32	\$ 55,647	Lightnin	386	m <sup>3</sup>	32	0.85	27	354	m <sup>3</sup>	30	\$ 52,799	2
1	400-AG-03	400	AG	03	Copper Extraction Mixer Settler Agitator	4.2 m dia x 8.4 m	\$ 41,000	23	\$ 40,920	Lightnin	231	m <sup>3</sup>	23	0.85	20	354	m <sup>3</sup>	30	\$ 52,799	2
1	400-AG-04	400	AG	04	Copper Extraction Mixer Settler Agitator	4.2 m dia x 8.4 m	\$ 41,000	23	\$ 40,920	Lightnin	231	m <sup>3</sup>	23	0.85	20	354	m <sup>3</sup>	30	\$ 52,799	2
1	400-AG-05	400	AG	05	Stripping Liquor Tank Agitator	2m dia x 4 m	\$ 4,000	2	\$ 3,868	Lightnin	23	m <sup>3</sup>	2	0.85	2	33	m <sup>3</sup>	2.2	\$ 4,829	2
1	400-AG-06	400	AG	06	Scrubbing Solution Tank Agitator	5 m dia x 10 m	\$ 56,000	32	\$ 55,647	Lightnin	386	m <sup>3</sup>	32	0.85	27	354	m <sup>3</sup>	30	\$ 52,799	2
1	400-AG-07	400	AG	07	Copper Stripping Mixer Settler Agitator	3.4 m dia x 6.8 m	\$ 28,000	16	\$ 27,841	Lightnin	123	m <sup>3</sup>	16	0.85	13	354	m <sup>3</sup>	30	\$ 52,799	2
1	400-AG-08	400	AG	08	Copper Stripping Mixer Settler Agitator	3.4 m dia x 6.8 m	\$ 28,000	16	\$ 27,841	Lightnin	123	m <sup>3</sup>	16	0.85	13	354	m <sup>3</sup>	30	\$ 52,799	2
1	400-AG-09	400	AG	09	Scrubbing Mixer Settler Agitator	3.4 m dia x 6.8 m	\$ 15,000	14	\$ 14,129	Lightnin	123	m <sup>3</sup>	14	0.85	12	86	m <sup>3</sup>	11	\$ 11,423	2
1	400-AG-10	400	AG	10	SX Waste Tank Agitator	2.8 m dia x 5.6 m	\$ 7,000	6	\$ 6,072	Lightnin	30	m <sup>3</sup>	6	0.85	5	86	m <sup>3</sup>	11	\$ 11,423	2
1	400-AG-11	400	AG	11	Cool Treatment Tank Agitator	2.8 m dia x 5.6 m	\$ 7,000	6	\$ 6,072	Lightnin	30	m <sup>3</sup>	6	0.85	5	86	m <sup>3</sup>	11	\$ 11,423	2
1	400-CF-01	400	CF	01	Centrifuge		\$ 249,000	18	\$ 249,817		3	t <sup>hr</sup>	18	0.85	16	8	t <sup>hr</sup>	37	\$ 500,000	2
1	400-CH-01	400	CH	01	Filter Press Discharge Chute	Constructed On Site	\$ 5,000	0	\$ 4,500	Local fabrication										4
1	400-CV-01	400	CV	01	Neutralised Tailings Transfer Conveyor	600 mm x 200 m x 10 m	\$ 360,000	21	\$ 360,000	Sanwest	9	t <sup>hr</sup>	21	0.85	18	1	m		\$ 1,800	2
2	400-CV-02-03	400	CV	02-03	Stripped Sheet Conveyor	600 mm x 20 m	\$ 72,000	22	\$ 36,000	Sanwest	2	t <sup>hr</sup>	11	0.85	19	1	m		\$ 1,800	2
2	400-CV-04-05	400	CV	04-05	Cathode Discharge Conveyor	600 mm x 20 m	\$ 72,000	22	\$ 36,000	Sanwest	3	t <sup>hr</sup>	11	0.85	19	1	m		\$ 1,800	2
244	400-EC-01-244	400	EC	01-244	Electrowinning Cells		\$ 14,883,000	14577	\$ 14,882,710		49997		1.00	14577	11000	tpa			\$ 6,000,000	4
2	400-FL-01-02	400	FL	01-02	pH Adjustment Filter Press	Pressure filter Dienne Me1500,2800 MB	\$ 142,000	33	\$ 70,871		8	t <sup>hr</sup>	17	0.85	28	50	t <sup>hr</sup>	50	\$ 214,286	2
3	400-FL-03-05	400	FL	03-05	Polishing Filter	Candle Filter	\$ 1,538,000	237	\$ 511,822		1543	m <sup>3</sup> h	79	0.85	201	720	m <sup>3</sup> h	50	\$ 324,000	2
1	400-HE-01	400	HE	01	Heater and Cooling System	SX Feed Intercooler-MBMFG	\$ 8,000	0	\$ 7,500	Alfa Laval										4
1	400-HE-02	400	HE	02	Heater and Cooling System	SX Feed Intercooler-MBMFG	\$ 8,000	0	\$ 7,500	Alfa Laval										4
1	400-HE-03	400	HE	03	Heater and Cooling System	SX Feed Intercooler-MBMFG	\$ 8,000	0	\$ 7,500	Alfa Laval										4
1	400-HE-04	400	HE	04	Heater and Cooling System	SX Feed Intercooler-MBMFG	\$ 8,000	0	\$ 7,500	Alfa Laval										4
1	400-HE-05	400	HE	05	Heater and Cooling System	SX Feed Intercooler-MBMFG	\$ 8,000	0	\$ 7,500	Alfa Laval										4
1	400-HE-06	400	HE	06	Heater and Cooling System	SX Feed Intercooler-MBMFG	\$ 8,000	0	\$ 7,500	Alfa Laval										4
1	400-HE-07	400	HE	07	Heater and Cooling System	SX Feed Intercooler-MBMFG	\$ 8,000	0	\$ 7,500	Alfa Laval										4
1	400-HE-08	400	HE	08	Heater and Cooling System	SX Feed Intercooler-MBMFG	\$ 8,000	0	\$ 7,500	Alfa Laval										4
1	400-HE-09	400	HE	09	Heater and Cooling System	SX Feed Intercooler-MBMFG	\$ 8,000	0	\$ 7,500	Alfa Laval										4
1	400-HE-10	400	HE	10	Heater and Cooling System	SX Feed Intercooler-MBMFG	\$ 8,000	0	\$ 7,500	Alfa Laval										4
2	400-ME-01-02	400	ME	01-02	Crane		\$ 300,000	0	\$ 150,000											6
1	400-PP-01	400	PP	01	pH Adjustment Tank Pump (Duty)	MC 200-355	\$ 136,000	239	\$ 135,200	Weir	4638	m <sup>3</sup> h	239	0.75	179	402	m <sup>3</sup> h	55	\$ 31,170	2
1	400-PP-02	400	PP	02	pH Adjustment Tank Pump (Standby)	MC 200-355	\$ 136,000	239	\$ 135,200	Weir	4638	m <sup>3</sup> h	239	0.00	0	402	m <sup>3</sup> h	55	\$ 31,170	2
1	400-PP-03	400	PP	03	Thickener Underflow Pump (Duty)	MC 200-355	\$ 4,000	6	\$ 3,545	Weir	11	m <sup>3</sup> h	6	0.75	5	402	m <sup>3</sup> h	55	\$ 31,170	2
1	400-PP-04	400	PP	04	Thickener Underflow Pump (Standby)	MC 200-355	\$ 4,000	6	\$ 3,545	Weir	11	m <sup>3</sup> h	6	0.00	0	402	m <sup>3</sup> h	55	\$ 31,170	2
1	400-PP-05	400	PP	05	Filtrate Recycling Pump (Duty)	MC 200-355	\$ 3,000	5	\$ 2,952	Weir	8	m <sup>3</sup> h	5	0.75	4	402	m <sup>3</sup> h	55	\$ 31,170	2
1	400-PP-06	400	PP	06	Filtrate Recycling Pump (Standby)	MC 200-355	\$ 3,000	5	\$ 2,952	Weir	8	m <sup>3</sup> h	5	0.00	0	402	m <sup>3</sup> h	55	\$ 31,170	2
1	400-PP-07	400	PP	07	Polishing Filter Pump (Duty)	MC 200-355	\$ 136,000	238	\$ 135,062	Weir	4630	m <sup>3</sup> h	238	0.75	179	402	m <sup>3</sup> h	55	\$ 31,170	2
1	400-PP-08	400	PP	08	Polishing Filter Pump (Standby)	MC 200-355	\$ 136,000	238	\$ 135,062	Weir	4630	m <sup>3</sup> h	238	0.00	0	402	m <sup>3</sup> h	55	\$ 31,170	2
1	400-PP-09	400	PP	09	Copper SX PLS Feed Pump (Duty)	MC 200-355	\$ 136,000	238	\$ 135,062	Weir	4630	m <sup>3</sup> h	238	0.75	179	402	m <sup>3</sup> h	55	\$ 31,170	2
1	400-PP-10	400	PP	10	Copper SX PLS Feed Pump (Standby)	MC 200-355	\$ 136,000	238	\$ 135,062	Weir	4630	m <sup>3</sup> h	238	0.00	0	402	m <sup>3</sup> h	55	\$ 31,170	2
1	400-PP-11	400	PP	11	Organic Transfer Pump (Duty)	MC 200-355	\$ 136,000	238	\$ 135,062	Weir	4630	m <sup>3</sup> h	238	0.75	179	402	m <sup>3</sup> h	55	\$ 31,170	2
1	400-PP-12	400	PP	12	Organic Transfer Pump (Standby)	MC 200-355	\$ 136,000	238	\$ 135,062	Weir	4630	m <sup>3</sup> h	238	0.00	0	402	m <sup>3</sup> h	55	\$ 31,170	2
1	400-PP-13	400	PP	13	Copper Extraction Crud Transfer Pump (Duty)	Peristaltic Pump	\$ 6,000	1	\$ 5,404	Flowrex	1	m <sup>3</sup> h	1	0.75	1	0.53	m <sup>3</sup> h	0.75	\$ 3,692	2
1	400-PP-14	400	PP	14	Copper Extraction Crud Transfer Pump (Standby)	Peristaltic Pump	\$ 6,000	1	\$ 5,404	Flowrex	1	m <sup>3</sup> h	1	0.00	0	0.53	m <sup>3</sup> h	0.75	\$ 3,692	2
1	400-PP-15	400	PP	15	Raffinate Pump (Duty)	MC 200-355	\$ 136,000	238	\$ 135,062	Weir	4630	m <sup>3</sup> h	238	0.75	179	402	m <sup>3</sup> h	55	\$ 31,170	2
1	400-PP-16	400	PP	16	Raffinate Pump (Standby)	MC 200-355	\$ 136,000	238	\$ 135,062	Weir	4630	m <sup>3</sup> h	238	0.00	0	402	m <sup>3</sup> h	55	\$ 31,170	2
1	400-PP-17	400	PP	17	Loaded Organic Pump (Duty)	MC 200-355	\$ 136,000	130	\$ 135,062	Weir	4630	m <sup>3</sup> h	130	0.75	98	402	m <sup>3</sup> h	30	\$ 31,170	2
1	400-PP-18	400	PP	18	Loaded Organic Pump (Standby)	MC 200-355	\$ 136,000	130	\$ 135,062	Weir	4630	m <sup>3</sup> h	130	0.00	0	402	m <sup>3</sup> h	30	\$ 31,170	2
1	400-PP-19	400	PP	19	Copper Extraction Crud Transfer Pump (Duty)	Peristaltic Pump	\$ 6,000	1	\$ 5,404	Flowrex	1	m <sup>3</sup> h	1	0.75	1	0.53	m <sup>3</sup> h	0.75	\$ 3,692	2
1	400-PP-20	400	PP	20	Copper Extraction Crud Transfer Pump (Standby)	Peristaltic Pump	\$ 6,000	1	\$ 5,404	Flowrex	1	m <sup>3</sup> h	1	0.00						

Quantity	Equipment Number	Area Number	Equipment	Tag	Description	Model/Type (equivalent or similar)	Equipment Price (USD)	Estimated Power (kW)	Scaled Cost USD	Supplier	Scaled Capacity	Units	Scaled Power (kW)	Diversity	Diversified Power (kW)	Basis Capacity	Units	Basis Power (kW)	Basis Cost (USD)	Reference	
1	400-PP-49	400	PP	49	Crud Treatment Tank Discharge Pump (Duty)	Peristaltic Pump	\$ 15,000	3	\$ 14,193	Flowrex	5	m <sup>3</sup> /h	3	0.75	2	0.53	m <sup>3</sup> /h	0.75	\$ 3,692	2	
1	400-PP-50	400	PP	50	Crud Treatment Tank Discharge Pump (Standby)	Peristaltic Pump	\$ 15,000	3	\$ 14,193	Flowrex	5	m <sup>3</sup> /h	3	0.00	0	0.53	m <sup>3</sup> /h	0.75	\$ 3,692	2	
1	400-PP-51	400	PP	51	Centrate Recycle Pump (Duty)	MC 200-355	\$ 3,000	4	\$ 2,242	Weir	5	m <sup>3</sup> /h	4	0.75	3	402	m <sup>3</sup> /h	55	\$ 31,170	2	
1	400-PP-52	400	PP	52	Centrate Recycle Pump (Standby)	MC 200-355	\$ 3,000	4	\$ 2,242	Weir	5	m <sup>3</sup> /h	4	0.00	0	402	m <sup>3</sup> /h	55	\$ 31,170	2	
2	400-PP-53/55	400	PP	53/55	Electrowinning Feed Pump (Duty)		\$ 30,000	5	\$ 14,653	Weir	273	m <sup>3</sup> /h	2	0.75	4	75	m <sup>3</sup> /h	1.1	\$ 6,752	2	
2	400-PP-54/56	400	PP	54/56	Electrowinning Feed Pump (Standby)		\$ 30,000	5	\$ 14,653	Weir	273	m <sup>3</sup> /h	2	0.00	0	75	m <sup>3</sup> /h	1.1	\$ 6,752	2	
2	400-PP-57/59	400	PP	57/59	Electrowinning Discharge Pump (Duty)		\$ 30,000	5	\$ 14,653	Weir	273	m <sup>3</sup> /h	2	0.75	4	75	m <sup>3</sup> /h	1.1	\$ 6,752	2	
2	400-PP-58/60	400	PP	58/60	Electrowinning Discharge Pump (Standby)		\$ 30,000	5	\$ 14,653	Weir	273	m <sup>3</sup> /h	2	0.00	0	75	m <sup>3</sup> /h	1.1	\$ 6,752	2	
2	400-PP-61/63	400	PP	61/63	Cathode Washing Tank Discharge Pump (Duty)		\$ 6,000	1	\$ 2,868	Weir	18	m <sup>3</sup> /h	0.5	0.75	1	75	m <sup>3</sup> /h	1.1	\$ 6,752	2	
2	400-PP-62/64	400	PP	62/64	Cathode Washing Tank Discharge Pump (Standby)		\$ 6,000	1	\$ 2,868	Weir	18	m <sup>3</sup> /h	0.5	0.00	0	75	m <sup>3</sup> /h	1.1	\$ 6,752	2	
2	400-PP-65/67	400	PP	65/67	Stripping Liquor Return Pump (Duty)		\$ 30,000	5	\$ 14,653	Weir	273	m <sup>3</sup> /h	2.4	0.75	4	75	m <sup>3</sup> /h	1.1	\$ 6,752	2	
2	400-PP-66/68	400	PP	66/68	Stripping Liquor Return Pump (Standby)		\$ 30,000	5	\$ 14,653	Weir	273	m <sup>3</sup> /h	2.4	0.00	0	75	m <sup>3</sup> /h	1.1	\$ 6,752	2	
1	400-PS-01	400	PS	01	Copper EX Mixer Settler Sump Pump		\$ 12,000	0	\$ 11,106											4	
1	400-PS-02	400	PS	02	Copper Stripping Mixer Settler Sump Pump		\$ 12,000	0	\$ 11,106											4	
1	400-PS-03	400	PS	03	Scrubbing Sump Pump		\$ 12,000	0	\$ 11,106											4	
2	400-PS-04/05	400	PS	04/05	Electrowinning Sump Pump		\$ 23,000	0	\$ 11,106											4	
13	400-SH-01-13	400	SH	01-13	Safety Shower and Eyewash Station		\$ 13,000	0	\$ 1,000											4	
1	400-SX-01	400	SX	01	Scrubbing Mixer Settler	settler, DOP tank, Mixer tank	\$ 1,230,000	53	\$ 1,229,393	Outotec	1157	m <sup>3</sup> /h	53	0.75	40	442	m <sup>3</sup> /h	30	\$ 690,000	2	
1	400-SX-02	400	SX	02	Copper Extraction Mixer Settler	settler, DOP tank, Mixer tank	\$ 4,767,000	130	\$ 4,766,374	Outotec	9259	m <sup>3</sup> /h	130	0.75	98	804	m <sup>3</sup> /h	30	\$ 1,100,000	2	
1	400-SX-03	400	SX	03	Copper Extraction Mixer Settler	settler, DOP tank, Mixer tank	\$ 4,767,000	130	\$ 4,766,374	Outotec	9259	m <sup>3</sup> /h	130	0.75	98	804	m <sup>3</sup> /h	30	\$ 1,100,000	2	
1	400-SX-04	400	SX	04	Copper Stripping Mixer Settler	settler, DOP tank, Mixer tank	\$ 2,824,000	64	\$ 2,824,000	Outotec	4902	m <sup>3</sup> /h	64	0.75	48	442	m <sup>3</sup> /h	15	\$ 690,000	2	
1	400-SX-05	400	SX	05	Copper Stripping Mixer Settler	settler, DOP tank, Mixer tank	\$ 2,824,000	64	\$ 2,823,113	Outotec	4902	m <sup>3</sup> /h	64	0.75	48	442	m <sup>3</sup> /h	15	\$ 690,000	2	
1	400-TH-01	400	TH	01	pH Adjustment Thickener		\$ 300,000	0	\$ 299,420	Waterex	9	m							\$ 499,800	2	
1	400-TK-01	400	TK	01	pH Adjustment Tank	GL13/04 Steel 6.02m D x 4.27m, 122kL	\$ 250,000	0	\$ 249,076	Pioneer	388	m <sup>3</sup>								\$ 250,000	2
1	400-TK-02	400	TK	02	SX PLS Feed Tank	GL13/04 Steel 6.02m D x 4.27m, 122kL	\$ 377,000	0	\$ 376,827	Pioneer	773	m <sup>3</sup>								\$ 250,000	2
1	400-TK-03	400	TK	03	Organic Control Tank	GL13/04 Steel 6.02m D x 4.27m, 122kL	\$ 47,000	0	\$ 46,694	Pioneer	386	m <sup>3</sup>								\$ 23,812	2
1	400-TK-04	400	TK	04	Loaded Organic Tank	GL13/04 Steel 6.02m D x 4.27m, 122kL	\$ 47,000	0	\$ 46,692	Pioneer	386	m <sup>3</sup>								\$ 23,812	2
1	400-TK-05	400	TK	05	Strip Liquor Makeup Tank	GL13/04 Steel 6.02m D x 4.27m, 122kL	\$ 21,000	0	\$ 20,601	Pioneer	23	m <sup>3</sup>								\$ 33,000	2
1	400-TK-06	400	TK	06	Scrubbing Solution Makeup Tank	GL13/04 Steel 6.02m D x 4.27m, 122kL	\$ 249,000	0	\$ 248,613	Pioneer	386	m <sup>3</sup>								\$ 250,000	2
1	400-TK-07	400	TK	07	PLS Tank	GL13/04 Steel 6.02m D x 4.27m, 122kL	\$ 249,000	0	\$ 248,613	Pioneer	386	m <sup>3</sup>								\$ 250,000	2
1	400-TK-08	400	TK	08	SX Waste Tank	GL13/04 Steel 6.02m D x 4.27m, 122kL	\$ 3,000	0	\$ 2,829	Pioneer	1	m <sup>3</sup>								\$ 33,000	2
1	400-TK-09	400	TK	09	Crud Treatment Tank	GL13/04 Steel 6.02m D x 4.27m, 122kL	\$ 13,000	0	\$ 12,564	Pioneer	10	m <sup>3</sup>								\$ 33,000	2
1	400-TK-10	400	TK	10	Centrate Collection Tank	GL13/04 Steel 6.02m D x 4.27m, 122kL	\$ 13,000	0	\$ 12,564	Pioneer	10	m <sup>3</sup>								\$ 33,000	2
2	400-TK-11/12	400	TK	11-12	Cathode Washing Tank	GL13/04 Steel 6.02m D x 4.27m, 122kL	\$ 391,000	0	\$ 195,038	Pioneer	396	m <sup>3</sup>								\$ 33,000	2
2	400-TK-13/14	400	TK	13-14	Stripping Liquor Tank	GL13/04 Steel 6.02m D x 4.27m, 122kL	\$ 42,000	0	\$ 20,601	Pioneer	29	m <sup>3</sup>								\$ 33,000	2
2	400-XM-01/02	400	XM	01-02	Cathode Flushing Station		\$ 100,000	0	\$ 50,000												4
2	400-XM-03/04	400	XM	03-04	Cathode Stripping Station		\$ 160,000	0	\$ 80,000												4
2	400-XM-05/06	400	XM	05-06	Cathode Waking Station		\$ 100,000	0	\$ 50,000												4
2	400-XM-07/08	400	XM	07-08	Cathode Strapping Station		\$ 160,000	0	\$ 80,000												4
2	400-XM-09/10	400	XM	09-10	Cathode Punch Station		\$ 100,000	0	\$ 50,000												4
2	400-XM-11/12	400	XM	11-12	Cathode Weighing Station		\$ 160,000	0	\$ 80,000												4
1	400-YTR-01	400	YTR	01	Foam/CO2 Fire Truck (for SX)		\$ 200,000	0	\$ 200,000												6
1	400-YTR-02	400	YTR	02	Copper Product Flatbed Truck		\$ 120,000	0	\$ 120,000												6
1	500-AG-01	500	AG	01	Precipitation Tank Agitator	5m dia x 10 m	\$ 49,000	28	\$ 48,833	Mitotec	311	m <sup>2</sup>	28	0.85	24	354	m <sup>2</sup>	30	\$ 52,799	2	
1	500-AG-02	500	AG	02	Iron Tailings Filter Feed Tank Agitator	5m dia x 10 m	\$ 49,000	28	\$ 48,833	Mitotec	311	m <sup>2</sup>	28	0.85	24	354	m <sup>2</sup>	30	\$ 52,799	2	
2	500-CH-01/02	500	CH	01-02	Filter Press Discharge Crane	Consulted On Site	\$ 9,000	0	\$ 4,500	Local fabrication	217	th	22	0.85	19	1	m		\$ 1,900	2	
1	500-CV-01	500	CV	01	Filter Press Discharge Conveyor	600 mm x 50 m x 10 m	\$ 90,000	22	\$ 90,000	Starwest	217	th	22	0.85	19	1750	th		\$ 600,000	2	
2	500-CV-02	500	CV	02	Tailings Handling Conveyor	Rail Mounted Radial Stacker. 600 mm x 50 m x 15 m	\$ 181,000	22	\$ 180,036	Krupp	92	th	72	0.85	123	50	th	50	\$ 214,296	2	
2	500-FL-01/02	500	FL	01-02	Iron Tailings Filter Press		\$ 619,000	144	\$ 309,181												4
1	500-PP-01	500	PP	01	Precipitation Tank Pump (Duty)	SDB 200/250/Centrifugal	\$ 20,000	54	\$ 19,164	Weir	311	m <sup>3</sup> /h	54	0.75	40	1400	m <sup>3</sup> /h	132	\$ 47,279	2	
1	500-PP-02	500	PP	02	Precipitation Tank Pump (Standby)	SDB 200/250/Centrifugal	\$ 20,000	54	\$ 19,164	Weir	311	m <sup>3</sup> /h	54	0.00	0	1400	m <sup>3</sup> /h	132	\$ 47,279	2	
1	500-PP-03	500	PP	03	Thickener U/F Pump (Duty)	SDB 200/250/Centrifugal	\$ 17,000	47	\$ 16,818	Weir	250	m <sup>3</sup> /h	47	0.75	35	1400	m <sup>3</sup> /h	132	\$ 47,279	2	
1	500-PP-04	500	PP	04	Thickener U/F Pump (Standby)	SDB 200/250/Centrifugal	\$ 17,000	47	\$ 16,818	Weir	250	m <sup>3</sup> /h	47	0.00	0	1400	m <sup>3</sup> /h	132	\$ 47,279	2	
1	500-PP-05	500	PP	05	Barren Solution Pond Feed Pump (Duty)	Warman 3z2AH	\$ 40,000	24	\$ 39,554	Weir	1709	m <sup>3</sup> /h	24	0.75	18	150	m <sup>3</sup> /h	5.5	\$ 9,188	2	
1	500-PP-06	500	PP	06	Barren Solution Pond Feed Pump (Standby)	Warman 3z2AH	\$ 40,000	24	\$ 39,554	Weir	1709	m <sup>3</sup> /h	24	0.00	0	150	m <sup>3</sup> /h	5.5	\$ 9,188	2	
1	500-PP-07	500	PP	07	Filter Feed Pump (Duty)	Warman 3z2AH	\$ 13,000	7	\$ 12,484	Weir	250	m <sup>3</sup> /h	7	0.75	6	150	m <sup>3</sup> /h	5.5	\$ 9,188	2	
1	500-PP-08	500	PP	08	Filter Feed Pump (Standby)	Warman 3z2AH	\$ 13,000	7	\$ 12,484	Weir	250	m <sup>3</sup> /h	7	0.00	0	150	m <sup>3</sup> /h	5.5	\$ 9,188	2	
1	500-PP-09	500	PP	09	Filtrate Pump (Duty)	Warman 3z2AH	\$ 8,000	5	\$ 7,560	Weir	108	m <sup>3</sup> /h	5	0.75	3	150	m <sup>3</sup> /h	5.5	\$ 9,188	2	
1	500-PP-10	500	PP	10	Filtrate Pump (Standby)	Warman 3z2AH	\$ 8,000	5	\$ 7,560	Weir	108	m <sup>3</sup> /h	5	0.00	0	150	m <sup>3</sup> /h	5.5	\$ 9,188	2	
1	500-PP-11	500	PP	11	Filtrate Pump (Duty)	Warman 3z2AH	\$ 8,000	5	\$ 7,560	Weir	108	m <sup>3</sup> /h	5	0.75	3	150	m <sup>3</sup> /h	5.5	\$ 9,188	2	
1	500-PP-12	500	PP	12	Filtrate Pump (Standby)	Warman 3z2AH	\$ 8,000	5	\$ 7,560	Weir	108	m <sup>3</sup> /h	5	0.00	0	150	m <sup>3</sup> /h	5.5	\$ 9,188	2	
1	500-PS-01	500	PS	01	Thickener Sump Pump		\$ 12,000	0	\$ 11,106											4	
1	500-PS-02	500	PS	02	Filter Press Sump Pump		\$ 12,000	0	\$ 11,106											4	
1	500-PS-03	500	PS	03	Filter Press Sump Pump		\$ 12,000	0	\$ 11,106											4	
1	500-SH-01	500	SH	01	Safety Shower and Eyewash Station		\$ 4,000	0	\$ 4,000											4	
1	500-TH-01	500	TH	01	Thickener		\$ 770,000	0	\$ 769,947	Waterex	41	m							\$ 499,800	2	
1	500-TK-01	500	TK	01	Precipitation Tank	GL13/04 Steel 6.02m D x 4.27m, 122kL	\$ 219,000	0	\$ 218,167	Pioneer	311	m <sup>3</sup>							\$ 250,000	2	
1	500-TK-02	500	TK	02	Iron Tailings Filter Feed Tank	GL13/04 Steel 6.02m D x 4.27m, 122kL	\$ 219,000	0	\$ 218,167	Pioneer	311	m <sup>3</sup>							\$ 250,000		

Quantity	Equipment Number	Area Number	Equipment	Tag	Description	Model/Type (equivalent or similar)	Equipment Price (USD)	Estimated Power (kW)	Scaled Cost USD	Supplier	Scaled Capacity	Units	Scaled Power (kW)	Diversity	Diversified Power (kW)	Basis Capacity	Units	Basis Power (kW)	Basis Cost (USD)	Reference
1	600-TK-01	600	TK	01	Process Water Distribution Tank-Mining Area	Steel Tank with rubber liners, colourbond finish	\$ 78,000	0	\$ 77,383	Pioneer	360	m <sup>3</sup>				2660	m <sup>3</sup>		\$ 256,916	2
1	600-TK-02	600	TK	02	Raw Water Distribution Tank	Water Tank	\$ 521,000	0	\$ 520,928	Pioneer	8640	m <sup>3</sup>				2660	m <sup>3</sup>		\$ 256,916	4
1	600-TK-03	600	TK	03	Process Water Distribution Tank-Processing Area	Steel Tank with rubber liners, colourbond finish	\$ 204,000	0	\$ 203,245	Pioneer	1800	m <sup>3</sup>				2660	m <sup>3</sup>		\$ 256,916	2
1	700-AG-01	700	AG	01	Lime Slurry Distribution Tank Agitator	1.4 m dia x 2.8 m	\$ 3,000	1	\$ 2,125	Mittec	8	m <sup>3</sup>	1	0.85	1	33	m <sup>3</sup>	2.2	\$ 4,829	2
1	700-AG-02	700	AG	02	Limestone/Calcrete Slurry Distribution Tank Agitator	3.4 m dia x 6 m	\$ 7,000	6	\$ 6,500	Mittec	34	m <sup>3</sup>	6	0.85	5	86	m <sup>3</sup>	11	\$ 11,423	2
1	700-AG-03	700	AG	03	LX Mixing Tank Agitator	1 m dia x 2 m	\$ 2,000	1	\$ 1,937	Mittec	7.2	m <sup>3</sup>	0.9	0.85	1	33	m <sup>3</sup>	2.2	\$ 4,829	2
1	700-BN-01	700	BN	01	Quicklime Feed Silo		\$ 185,000		\$ 184,942	Local Fabrication	60	m <sup>3</sup>				100	m <sup>3</sup>		\$ 251,273	2
1	700-BN-02	700	BN	02	Limestone/Calcrete Feed Silo		\$ 236,000		\$ 235,880	Local Fabrication	90	m <sup>3</sup>				100	m <sup>3</sup>		\$ 251,273	2
1	700-FE-01	700	FE	01	Quicklime Feeder	Belt Feeder	\$ 6,000	2	\$ 5,051	Meliso	2.2	t/hr	2	0.75	2	320	t/hr	10	\$ 100,500	3
1	700-FE-02	700	FE	02	Limestone/Calcrete Feeder	Belt Feeder	\$ 13,000	1	\$ 12,358	Meliso	9.7	t/hr	1	0.75	1	320	t/hr	10	\$ 100,500	3
1	700-MH-01	700	MH	01	Bulk Bag Monorail and Hoist		\$ 18,000	0	\$ 18,000	Eitelbeck Cranes										6
1	700-ME-01	700	ME	01	Forklift		\$ 30,000	0	\$ 30,000											2
1	700-ME-02	700	ME	02	Crane		\$ 150,000	0	\$ 150,000											6
1	700-ME-03	700	ME	03	Crane		\$ 150,000	0	\$ 150,000											6
1	700-PK-01	700	PK	01	Lime Staking Mill		\$ 450,000	0	\$ 450,000											4
1	700-PK-02	700	PK	02	Guar Gum Vendor Package		\$ 250,000	0	\$ 250,000											2
1	700-PK-03	700	PK	03	Cobalt Sulphate Vendor Package		\$ 50,000	0	\$ 50,000											4
1	700-PK-04	700	PK	04	Polycrylamide Vendor Package		\$ 250,000	0	\$ 250,000											4
1	700-PK-05	700	PK	05	Flocculant Vendor Package		\$ 118,000	4	\$ 117,079	Transmin	19.21	kg/hr	4	0.50	2	218	kg/hr	15	\$ 502,785	2
1	700-PP-01	700	PP	01	Lime Transfer Pump (Duty)		\$ 4,000	1	\$ 4,000	Allied Coloids	2.2	m <sup>3</sup> /h	0.1	0.75	0	75	m <sup>3</sup> /h	1.1	\$ 6,752	2
1	700-PP-02	700	PP	02	Lime Transfer Pump (Standby)		\$ 4,000	1	\$ 4,000	Allied Coloids	2.2	m <sup>3</sup> /h	0.1	0.75	0	75	m <sup>3</sup> /h	1.1	\$ 6,752	2
1	700-PP-03	700	PP	03	Lime Metering Pump (Duty)		\$ 4,000	1	\$ 4,000	Allied Coloids	2.2	m <sup>3</sup> /h	0.1	0.75	0	75	m <sup>3</sup> /h	1.1	\$ 6,752	2
1	700-PP-04	700	PP	04	Lime Metering Pump (Standby)		\$ 4,000	1	\$ 4,000	Allied Coloids	2.2	m <sup>3</sup> /h	0.1	0.75	0	75	m <sup>3</sup> /h	1.1	\$ 6,752	2
1	700-PP-05	700	PP	05	Lime Metering Pump (Duty)		\$ 4,000	1	\$ 4,000	Allied Coloids	2.2	m <sup>3</sup> /h	0.14	0.75	0	75	m <sup>3</sup> /h	1.1	\$ 6,752	2
1	700-PP-06	700	PP	06	Lime Metering Pump (Standby)		\$ 4,000	1	\$ 4,000	Allied Coloids	2.2	m <sup>3</sup> /h	0.14	0.75	0	75	m <sup>3</sup> /h	1.1	\$ 6,752	2
1	700-PP-07	700	PP	07	Lime Metering Pump (Duty)		\$ 4,000	1	\$ 4,000	Allied Coloids	2.2	m <sup>3</sup> /h	0.1	0.75	0	75	m <sup>3</sup> /h	1.1	\$ 6,752	2
1	700-PP-08	700	PP	08	Lime Metering Pump (Standby)		\$ 4,000	1	\$ 4,000	Allied Coloids	2.2	m <sup>3</sup> /h	0.1	0.75	0	75	m <sup>3</sup> /h	1.1	\$ 6,752	2
1	700-PP-09	700	PP	09	Limestone Metering Pump (Duty)		\$ 14,000	1	\$ 14,000	Allied Coloids	9.7	m <sup>3</sup> /h	0.3	0.75	0	75	m <sup>3</sup> /h	1.1	\$ 6,752	2
1	700-PP-10	700	PP	10	Limestone Metering Pump (Standby)		\$ 14,000	1	\$ 14,000	Allied Coloids	9.7	m <sup>3</sup> /h	0.3	0.75	0	75	m <sup>3</sup> /h	1.1	\$ 6,752	2
1	700-PP-11	700	PP	11	Limestone Metering Pump (Duty)		\$ 14,000	1	\$ 14,000	Allied Coloids	9.7	m <sup>3</sup> /h	0.33	0.75	0	75	m <sup>3</sup> /h	1.1	\$ 6,752	2
1	700-PP-12	700	PP	12	Limestone Metering Pump (Standby)		\$ 14,000	1	\$ 14,000	Allied Coloids	9.7	m <sup>3</sup> /h	0.33	0.75	0	75	m <sup>3</sup> /h	1.1	\$ 6,752	2
1	700-PP-13	700	PP	13	Limestone Metering Pump (Duty)		\$ 14,000	1	\$ 14,000	Allied Coloids	9.7	m <sup>3</sup> /h	0.3	0.75	0	75	m <sup>3</sup> /h	1.1	\$ 6,752	2
1	700-PP-14	700	PP	14	Limestone Metering Pump (Standby)		\$ 14,000	1	\$ 14,000	Allied Coloids	9.7	m <sup>3</sup> /h	0.3	0.75	0	75	m <sup>3</sup> /h	1.1	\$ 6,752	2
1	700-PP-15	700	PP	15	Acid Metering Pump (Duty)		\$ 30,000	5	\$ 29,789	1.6	m <sup>3</sup> /h	5	0.75	4	0.037	m <sup>3</sup> /h	0.55	\$ 3,111	2	
1	700-PP-16	700	PP	16	Acid Metering Pump (Standby)		\$ 30,000	5	\$ 29,789	1.6	m <sup>3</sup> /h	5	0.75	4	0.037	m <sup>3</sup> /h	0.55	\$ 3,111	2	
1	700-PP-17	700	PP	17	Acid Metering Pump (Duty)		\$ 30,000	5	\$ 29,789	1.6	m <sup>3</sup> /h	5	0.75	4	0.037	m <sup>3</sup> /h	0.55	\$ 3,111	2	
1	700-PP-18	700	PP	18	Acid Metering Pump (Standby)		\$ 30,000	5	\$ 29,789	1.6	m <sup>3</sup> /h	5	0.75	4	0.037	m <sup>3</sup> /h	0.55	\$ 3,111	2	
1	700-PP-19	700	PP	19	Acid Metering Pump (Duty)		\$ 30,000	5	\$ 29,789	1.6	m <sup>3</sup> /h	5.27	0.75	4	0.037	m <sup>3</sup> /h	0.55	\$ 3,111	2	
1	700-PP-20	700	PP	20	Acid Metering Pump (Standby)		\$ 30,000	5	\$ 29,789	1.6	m <sup>3</sup> /h	5.27	0.75	4	0.037	m <sup>3</sup> /h	0.55	\$ 3,111	2	
1	700-PP-21	700	PP	21	Acid Metering Pump (Duty)		\$ 30,000	5	\$ 29,789	1.6	m <sup>3</sup> /h	5	0.75	4	0.037	m <sup>3</sup> /h	0.55	\$ 3,111	2	
1	700-PP-22	700	PP	22	Acid Metering Pump (Standby)		\$ 30,000	5	\$ 29,789	1.6	m <sup>3</sup> /h	5	0.75	4	0.037	m <sup>3</sup> /h	0.55	\$ 3,111	2	
1	700-PP-23	700	PP	23	LX Transfer Pump (Duty)		\$ 8,800	1	\$ 8,800	Allied Coloids	70	L	1.0	0.75	1				\$ 3,111	2
1	700-PP-24	700	PP	24	LX Transfer Pump (Standby)		\$ 8,800	1	\$ 8,800	Allied Coloids	70	L	1.0	0.75	1				\$ 3,111	2
1	700-PP-25	700	PP	25	LX Metering Pump (Duty)		\$ 8,800	1	\$ 8,800	Allied Coloids	70	L	1.0	0.75	1				\$ 3,111	2
1	700-PP-26	700	PP	26	LX Metering Pump (Standby)		\$ 8,800	1	\$ 8,800	Allied Coloids	70	L	1.0	0.75	1				\$ 3,111	2
1	700-PP-27	700	PP	27	Kerosene Metering Pump (Duty)	Mono B021 in 316 S.S.	\$ 13,000	1	\$ 13,000	Challenge	473	L	1.0	0.75	1				\$ 3,111	2
1	700-PP-28	700	PP	28	Kerosene Metering Pump (Standby)	Mono B021 in 316 S.S.	\$ 13,000	1	\$ 13,000	Challenge	473	L	1.0	0.75	1				\$ 3,111	2
1	700-PP-29	700	PP	29	Kerosene Metering Pump (Duty)	Mono B021 in 316 S.S.	\$ 13,000	1	\$ 13,000	Challenge	473	L	1.0	0.75	1				\$ 3,111	2
1	700-PP-30	700	PP	30	Kerosene Metering Pump (Standby)	Mono B021 in 316 S.S.	\$ 13,000	1	\$ 13,000	Challenge	473	L	1.0	0.75	1				\$ 3,111	2
1	700-PS-01	700	PS	01	Lime Sump Pump		\$ 12,000	0	\$ 11,106											4
1	700-PS-02	700	PS	02	Limestone Sump Pump		\$ 12,000	0	\$ 11,106											4
1	700-PS-03	700	PS	03	Acid Sump Pump		\$ 12,000	0	\$ 11,106											4
1	700-PS-04	700	PS	04	LX Sump Pump		\$ 12,000	0	\$ 11,106											4
1	700-PS-05	700	PS	05	Guar Gum Sump Pump		\$ 12,000	0	\$ 11,106											4
1	700-PS-06	700	PS	06	Cobalt Sulphate Sump Pump		\$ 12,000	0	\$ 11,106											4
1	700-PS-07	700	PS	07	Kerosene Sump Pump		\$ 12,000	0	\$ 11,106											4
1	700-PS-08	700	PS	08	Polycrylamide Sump Pump		\$ 12,000	0	\$ 11,106											4
1	700-PS-09	700	PS	09	Flocculant Sump Pump		\$ 12,000	0	\$ 11,106											4
1	700-SH-01	700	SH	01	Safety Shower & Eye Wash Station		\$ 4,000	0	\$ 4,000											4
1	700-SH-02	700	SH	02	Safety Shower & Eye Wash Station		\$ 4,000	0	\$ 4,000											4
1	700-SH-03	700	SH	03	Safety Shower & Eye Wash Station		\$ 4,000	0	\$ 4,000											4
1	700-SHD-01	700	SHD	01	Reagent Shed	12x32x6 (w x l x h)	\$ 160,000	0	\$ 160,000											6
1	700-TK-01	700	TK	01	Lime Slurry Distribution Tank	Steel Tank c/w liner, colour bond finish	\$ 12,000	0	\$ 11,316	Pioneer	8	m <sup>3</sup>				50	m <sup>3</sup>		\$ 33,000	2
1	700-TK-02	700	TK	02	Limestone Slurry Distribution Tank	Steel Tank c/w liner, colour bond finish	\$ 26,000	0	\$ 25,998	Pioneer	34	m <sup>3</sup>				50	m <sup>3</sup>		\$ 33,000	2
1	700-TK-03	700	TK	03	Acid Storage Tank	Steel Tank c														

Quantity	Equipment Number	Area Number	Equipment	Tag	Description	Model/Type (equivalent or similar)	Equipment Price (USD)	Estimated Power (kW)	Scaled Cost USD	Supplier	Scaled Capacity	Units	Scaled Power (kW)	Diversity	Diversified Power (kW)	Basis Capacity	Units	Basis Power (kW)	Basis Cost (USD)	Reference
1	800-PP-11	800	PP	11	Fast Fill Bowser - Light Vehicle Pump		\$ 7,000	1	\$ 6,545											4
1	800-PP-12	800	PP	12	Fast Fill Bowser - Mobile Equipment Plant Pump		\$ 7,000	1	\$ 6,930											4
1	800-PP-13	800	PP	13	Diesel Distribution Pump (Duty)		\$ 2,000	1	\$ 1,386											4
1	800-PP-14	800	PP	14	Diesel Distribution Pump (Standby)		\$ 2,000	1	\$ 1,386											4
1	800-PP-15	800	PP	15	Cooling Water Pump (Duty)		\$ 5,000	1	\$ 4,235											4
1	800-PP-16	800	PP	16	Cooling Water Pump (Standby)		\$ 5,000	1	\$ 4,235											4
1	800-PP-17	800	PP	17	Cooling Water Distribution Pump (Duty)		\$ 5,000	1	\$ 4,235											4
1	800-PP-18	800	PP	18	Cooling Water Distribution Pump (Standby)		\$ 5,000	1	\$ 4,235											4
1	800-PP-19	800	PP	19	Heating Water Pump (Duty)		\$ 5,000	1	\$ 4,235											4
1	800-PP-20	800	PP	20	Heating Water Pump (Standby)		\$ 5,000	1	\$ 4,235											4
1	800-RA-01	800	RA	01	Air Receiver		\$ 18,000	0	\$ 17,715	S&L Engineering									4	
1	800-RA-02	800	RA	02	Instrument Air Receiver		\$ 18,000	0	\$ 17,715	S&L Engineering										4
1	800-TK-01	800	TK	01	Plant Potable Water Tank		\$ 37,000	0	\$ 36,960											4
1	800-TK-02	800	TK	02	Plant Potable Water Tank-Mining Area		\$ 37,000	0	\$ 36,960											4
1	800-TK-03	800	TK	03	Safety Shower Water Tank-Mining Area		\$ 37,000	0	\$ 36,960											4
1	800-TK-04	800	TK	04	Safety Shower Water Tank		\$ 37,000	0	\$ 36,960											4
1	800-TK-05	800	TK	05	Diesel Storage Tank		\$ 501,000	0	\$ 500,500											4
1	800-TK-06	800	TK	06	Cooling Water Recycle Tank		\$ 37,000	0	\$ 36,960											4
1	800-TK-07	800	TK	07	Cooling Water Storage Tank		\$ 37,000	0	\$ 36,960											4
1	800-TK-08	800	TK	08	Heating Water Recycle Tank		\$ 37,000	0	\$ 36,960											4
1	0-ME-01	0	ME	01	Workshop Forklift		\$ 35,000	0	\$ 35,000										\$ 17,250	6
1	0-ME-02	0	ME	02	Stores Forklift		\$ 35,000	0	\$ 35,000										\$ 17,250	6
1	0-ME-03	0	ME	03	General/Maintenance Light Vehicles		\$ 35,000	0	\$ 35,000										\$ 14,250	6
1	0-ME-04	0	ME	04	General/Maintenance Light Vehicles		\$ 35,000	0	\$ 35,000										\$ 14,250	6
1	0-ME-05	0	ME	05	General/Maintenance Light Vehicles		\$ 35,000	0	\$ 35,000										\$ 14,250	6
1	0-ME-06	0	ME	06	General/Maintenance Light Vehicles		\$ 35,000	0	\$ 35,000										\$ 14,250	6
1	0-ME-07	0	ME	07	Mobile Lighting Tower		\$ 21,000	0	\$ 20,405										\$ 15,000	6
1	0-ME-08	0	ME	08	Mobile Lighting Tower		\$ 21,000	0	\$ 20,405										\$ 15,000	6
1	0-ME-09	0	ME	09	Mobile Lighting Tower		\$ 21,000	0	\$ 20,405										\$ 15,000	6
1	0-ME-10	0	ME	10	Ambulance		\$ 90,000	0	\$ 90,000										\$ 29,250	6
1	0-ME-11	0	ME	11	Cherry Picker		\$ 116,000	0	\$ 115,500										\$ 87,000	6
1	0-ME-12	0	ME	12	Hoist		\$ 15,000	0	\$ 15,000										\$ 6,000	6
1	0-SHD-01	0	SHD	01	Office/Canteen	16x25x4 (w x l x h)	\$ 80,000	0	\$ 80,000											6
1	0-SHD-02	0	SHD	02	Security Gate House	12x33x4 (w x l x h)	\$ 80,000	0	\$ 80,000											6
1	0-SHD-03	0	SHD	03	Assay Laboratory	8x8x4 (w x l x h)	\$ 56,000	0	\$ 56,000											6
1	0-SHD-04	0	SHD	04	Metallurgical Laboratory	12x33x4 (w x l x h)	\$ 80,000	0	\$ 80,000											6
1	0-SHD-05	0	SHD	05	Stores	12x32x6 (w x l x h)	\$ 80,000	0	\$ 80,000											6
1	0-SHD-06	0	SHD	06	Workshop	12x32x6 (w x l x h)	\$ 80,000	0	\$ 80,000											6
1	0-SHD-07	0	SHD	07	Control Room	8x8x4 (w x l x h)	\$ 56,000	0	\$ 56,000											6
1	0-SHD-08	0	SHD	08	Admin Office	8x8x4 (w x l x h)	\$ 56,000	0	\$ 56,000											6
1	0-SHD-09	0	SHD	09	Medical Centre	8x8x4 (w x l x h)	\$ 56,000	0	\$ 56,000											6
1	0-YTD-01	0	YTD	01	Security Vehicle (4WD)		\$ 54,000	0	\$ 53,900										\$ 40,500	6
1	0-YTD-02	0	YTD	02	Security Vehicle (4WD)		\$ 54,000	0	\$ 53,900										\$ 40,500	6
1	0-YTR-01	0	YTR	01	Water Truck		\$ 193,000	0	\$ 192,500										\$ 144,750	6



Client  
 Deep South Resources  
 Project  
 Hail Leach Project - 20 Mtpa @85% Cu Recovery+CuSO4  
 Document Number  
 JS459-CAL-000-001

Quantity	Equipment Number	Area Number	Equipment	Tag	Description	Model/Type (equivalent or similar)	Equipment Price (USD)	Estimated Power (kW)	Scaled Cost (USD)	Supplier	Scaled Capacity	Units	Scaled Power (kW)	Diversity	Diversified Power (kW)	Basis Capacity	Units	Basis Power (kW)	Basis Cost (USD)	Reference		
1	100-BN-01	100	BN	01	ROM Bin		\$ 197,000		\$ 196,940	Local Fabrication	349	m <sup>2</sup>				229	m <sup>2</sup>		\$ 151,623	2		
5	100-BN-02-09	100	BN	02-08	Core Crusher Feed Bin		\$ 986,000		\$ 198,144	Local Fabrication	355	m <sup>2</sup>				74	m <sup>2</sup>		\$ 77,596	2		
3	100-BN-07-09	100	BN	07-09	Screen Feed Bin		\$ 812,000		\$ 270,570	Local Fabrication	593	m <sup>2</sup>				74	m <sup>2</sup>		\$ 77,596	2		
1	100-CR-01	100	CR	01	Gatory Crusher	CG930	\$ 4,536,000	660	\$ 4,536,000	Sanvick	3914	th	660	0.66	436						6	
5	100-CV-06-06	100	CV	02-06	Cone Crusher	CH970-03	\$ 5,231,000	3000	\$ 1,046,139	Sanvick	1262	th	650	0.84	2534							6
1	100-CV-01	100	CV	01	Primary Crusher Discharge Conveyor	1200mm x 150 m x 25 m	\$ 330,000	560	\$ 330,000	Sanvick	6408	th	550	0.85	468							2
5	100-CV-02-06	100	CV	02-06	Cone Crusher Feed Conveyor	1200 mm x 15 m	\$ 13,500	55	\$ 27,000	Sanvick	1282	th	11	0.85	47							2
1	100-CV-07	100	CV	07	Cone Crusher Discharge Conveyor	1200mm x 100 m x 25 m	\$ 220,000	560	\$ 220,000	Sanvick	6408	th	550	0.85	468							2
1	100-CV-08	100	CV	08	Screen Sift Discharge Conveyor	1200mm x 75 m x 10 m	\$ 165,000	350	\$ 165,000	Sanvick	3914	th	350	0.85	286							2
2	100-CV-09-10	100	CV	09-10	Crushed Ore Discharge Conveyor	1200 mm x 20 m	\$ 72,000	22	\$ 36,000	Sanvick	1957	th	11	0.85	19							2
1	100-CV-11	100	CV	11	Crushed Product Conveyor	1200 mm x 4500 m x 30 m	\$ 9,900,000	2000	\$ 9,900,000	Sanvick	3914	th	2020	0.85	1177							2
5	100-FE-01	100	FE	01	Primary Crusher Discharge Apron Feeder	Apron Feeder - 1219mm x 6000mm	\$ 532,000	275	\$ 531,895	Sanvick	3914	th	275	0.85	233							2
1	100-FE-02-06	100	FE	02-06	Cone Crusher Vibrating Feeder		\$ 505,000	202	\$ 101,085	Sanvick	1282	th	40	0.85	172							2
3	100-FE-01-09	100	FE	01-09	Crushed Product Screen Feeders		\$ 694,000	34	\$ 291,155	Sanvick	2136	th	31	0.75	70							2
2	100-FE-10-11	100	FE	10-11	Crushed Ore Stockpile Apron Feeder	Apron Feeder - 1219mm x 6000mm	\$ 702,000	362	\$ 359,922	Sanvick	1957	th	181	0.85	308							2
6	100-MD-01-08	100	MD	01-08	Metal Detector		\$ 18,000	0	\$ 23,000												4	
1	100-MG-01	100	MG	01	Tramp Metal Magnet		\$ 50,000	0	\$ 50,000												4	
1	100-RB-01	100	RB	01	Mobile Rock Breaker		\$ 88,000	0	\$ 87,150												4	
3	100-SC-01-03	100	SC	01-03	Crusher Product Screen	Metso TSS 2 Double-Deck Banana	\$ 1,548,000	198	\$ 515,914	Metso	20	m <sup>2</sup>	66	0.85	168							2
1	100-SH-01	100	SH	01	Primary Crusher Area Safety Shower and Eyewash Station		\$ 4,000	0	\$ 4,000													4
1	100-SH-02	100	SH	02	Screening Area Safety Shower and Eyewash Station		\$ 4,000	0	\$ 4,000													4
1	100-SH-03	100	SH	03	Cone Crusher Safety Shower and Eyewash Station		\$ 4,000	0	\$ 4,000													4
1	100-SV-01	100	SV	01	Surge Vault		\$ 294,000	0	\$ 293,694	Local Fabrication	725	m <sup>3</sup>										4
1	100-TP-01	100	TP	01	Cone Crusher Feed Tripper Conveyor		\$ 2,200,000	80	\$ 2,200,000		1282	th	80	0.85	68							4
1	100-TP-02	100	TP	02	Screen Feed Tripper Conveyor		\$ 2,200,000	80	\$ 2,200,000		6408	th	80	0.85	68							4
1	100-WS-01-04	100	WS	01-04	Water Storage		\$ 50,000	0	\$ 50,000													4
10	100-WT-01-10	100	WT	01-10	Weightmeter		\$ 325,000	0	\$ 32,500													4
1	100-SHD-01	100	SHD	01	Cruiser Control Room		\$ 25,000	0	\$ 24,283													4
1	100-VFL-01	100	VFL	01	Front End Loader		\$ 500,000	0	\$ 500,000													4
1	100-SP-01	100	SP	01	Crushed Product Stockpile		\$ 1,354,000	0	\$ 1,353,123		46967	1										4
1	200-SP-01	200	SP	01	HPGR Feed Stockpile		\$ 2,674,000	0	\$ 2,674,540		146119	1										4
2	200-BN-01-02	200	BN	01-02	HPGR Feed Bin		\$ 517,000	0	\$ 298,432	Local Fabrication	550	m <sup>2</sup>										2
4	200-BN-03-06	200	BN	03-06	Screen Feed Bin		\$ 883,000	0	\$ 170,501	Local Fabrication	275	m <sup>2</sup>										2
2	200-CV-01-02	200	CV	01-02	Stockpile Discharge Conveyor	1200 mm x 20 m	\$ 72,000	22	\$ 36,000	Sanvick	1522	th	11	0.85	19							2
1	200-CV-03	200	CV	03	HPGR Feed Conveyor	1200mm x 150 m x 25 m	\$ 330,000	350	\$ 330,000	Sanvick	3957	th	350	0.85	298							2
2	200-CV-04-06	200	CV	04-06	HPGR Feed Conveyors	1200 mm x 15 m	\$ 54,000	22	\$ 27,000	Sanvick	1978	th	11	0.85	19							2
1	200-CV-06	200	CV	06	Screen Feed Conveyor	1200mm x 100 m x 25 m	\$ 180,000	300	\$ 180,000	Sanvick	3957	th	300	0.85	255							2
1	200-CV-07	200	CV	07	Screen Discharge Conveyor	1200 mm x 75 m x 10 m	\$ 150,000	120	\$ 150,000	Sanvick	3044	th	120	0.85	102							2
2	200-FE-01-02	200	FE	01-02	HPGR Stockpile Apron Feeder		\$ 604,000	312	\$ 301,803	Sanvick	1522	th	156	0.85	265							2
1	200-FE-03-04	200	FE	03-04	HPGR Vibrating Feeder		\$ 263,000	105	\$ 131,179	Sanvick	1979	th	52	0.85	89							2
1	200-FE-05-08	200	FE	05-08	Screen Vibrating Feeder		\$ 347,000	138	\$ 86,548	Sanvick	989	th	35	0.85	118							2
1	200-GR-01-02	200	GR	01-02	HPGR	HPGR 630/17.6-OWH-1230-PG1E	\$ 13,695,000	9600	\$ 6,797,864	Koepure	1979	th	4400	0.75	745							2
2	200-MD-01-02	200	MD	01-02	Metal Detector		\$ 46,000	0	\$ 23,000													4
2	200-SC-01-04	200	SC	01-04	HPGR Screen		\$ 2,064,000	264	\$ 515,914	Metso	20	m <sup>2</sup>	66	0.75	198							2
1	200-SH-01	200	SH	01	Grinding Area Safety Shower and Eyewash Station	Metso T86 2 Double-Deck Banana	\$ 4,000	0	\$ 4,000													4
1	200-SH-02	200	SH	02	Screen Area Safety Shower and Eyewash Station		\$ 4,000	0	\$ 4,000													4
1	200-TP-01	200	TP	01	Screen Feed Tripper Conveyor		\$ 2,200,000	80	\$ 2,200,000													4
1	200-WS-01-03	200	WS	01-03	Water Storage		\$ 50,000	0	\$ 50,000													4
6	200-WT-01-06	200	WT	01-06	Weightmeter		\$ 195,000	0	\$ 32,500													4
1	200-VFL-01	200	VFL	01	Front End Loader		\$ 500,000	0	\$ 500,000													4
4	300-AD-01-04	300	AD	01-04	Agglomeration Drum	3810	\$ 5,400,000	960	\$ 1,350,000	Sepro Systems	400	m <sup>2</sup>	240	0.75	720							2
1	300-BN-01	300	BN	01	Agglomerator Feed Bin		\$ 198,000	0	\$ 197,911	Local Fabrication	352	m <sup>2</sup>										2
1	300-CH-01	300	CH	01	Filter Press Discharge Chute	Constructed On Site	\$ 5,000	0	\$ 4,500	Local fabrication												4
1	300-CV-01	300	CV	01	Agglomerator Feed Conveyor	1200 mm x 75 m x 25 m	\$ 165,000	125	\$ 165,000	Krupp	3044	th	125	0.85	106							2
2	300-CV-02-03	300	CV	02-03	Agglomerator Feed Conveyors	1200 mm x 75 m x 25 m	\$ 330,000	22	\$ 165,000	Krupp	1522	th	11	0.85	19							2
1	300-CV-04	300	CV	04	Agglomerator Product Conveyor	1200 mm x 150 m x 50 m	\$ 330,000	300	\$ 330,000	Krupp	3356	th	300	0.85	255							2
6	300-CV-05-09	300	CV	05-09	Crashcooper Conveyors	1200 mm x 50 m x 2.5 m	\$ 100,000	3356	\$ 100,000	Sanvick	3356	th	40	0.85	204							2
1	300-CV-10	300	CV	10	Radial Stacker for Primary Leach Heap	Radial Mounted Radial Stacker. 1200 mm x 50 m x 15 m	\$ 887,000	100	\$ 888,788	Krupp	3356	th	100	0.85	85							2
1	300-CV-11	300	CV	11	Neutralized Tailings Transfer Conveyor	600 mm x 20 m x 5 m	\$ 36,000	21	\$ 36,000	Sanvick	9	th	21	0.85	18							2
1	300-FE-01	300	FE	01	Belt Feeder		\$ 399,280	39	\$ 399,280	Metso	3044	th	39	0.85	33							2
1	300-IR-01	300	IR	01	Primary Heap Leach Drip Irrigation		\$ 117,000	0	\$ 117,000	120000	m											2
1	300-IR-02	300	IR	02	Secondary Heap Leach Drip Irrigation		\$ 117,000	0	\$ 117,000	120000	m											2
1	300-R-03																					

Quantity	Equipment Number	Area Number	Equipment	Tag	Description	Model/Type (equivalent or similar)	Equipment Price (USD)	Estimated Power (kW)	Scaled Cost (USD)	Supplier	Scaled Capacity	Units	Scaled Power (kW)	Diversity	Diversified Power (kW)	Basis Capacity	Units	Basis Power (kW)	Basis Cost (USD)	Reference
188	400-EA-188	400	EC	01-188	Electrowinning Cells		\$ 12,691,000	10941	\$ 12,691,727		38337	16a	150	1.00	10941	11000	16a	120	\$ 6,000,000	4
1	400-FD-01	400	FD	01	Flash Drying Circuit		\$ 92,000	156	\$ 951,623	Svedala	16	16	0.85	133	10	120	16	120	\$ 730,000	2
1	400-FE-01	400	FE	01	Flash Drier Feeder		\$ 74,000	42	\$ 73,798		16	16	1.0	0.85	35	1	0	8	\$ 14,220	2
2	400-FL-01-02	400	FL	01-02	pH Adjustment Filter Press		\$ 142,000	33	\$ 20,871	Alfa Laval	8	m <sup>3</sup>	17	0.85	28	50	8	50	\$ 214,286	4
3	400-FL-03-05	400	FL	03-05	Polishing Filter	Pressure filter Diemme M41500 2800 MB	\$ 1,536,000	237	\$ 511,922		1543	m <sup>3</sup> /h	49	0.85	201	720	m <sup>3</sup> /h	80	\$ 324,000	2
1	400-HE-01	400	HE	01	Heater and Cooling System	SX Feed Intercooler-MMFMG	\$ 8,000	0	\$ 7,500	Alfa Laval										4
1	400-HE-02	400	HE	02	Heater and Cooling System	SX Feed Intercooler-MMFMG	\$ 8,000	0	\$ 7,500	Alfa Laval										4
1	400-HE-03	400	HE	03	Heater and Cooling System	SX Feed Intercooler-MMFMG	\$ 8,000	0	\$ 7,500	Alfa Laval										4
1	400-HE-04	400	HE	04	Heater and Cooling System	SX Feed Intercooler-MMFMG	\$ 8,000	0	\$ 7,500	Alfa Laval										4
1	400-HE-05	400	HE	05	Heater and Cooling System	SX Feed Intercooler-MMFMG	\$ 8,000	0	\$ 7,500	Alfa Laval										4
1	400-HE-06	400	HE	06	Heater and Cooling System	SX Feed Intercooler-MMFMG	\$ 8,000	0	\$ 7,500	Alfa Laval										4
1	400-HE-07	400	HE	07	Heater and Cooling System	SX Feed Intercooler-MMFMG	\$ 8,000	0	\$ 7,500	Alfa Laval										4
1	400-HE-08	400	HE	08	Heater and Cooling System	SX Feed Intercooler-MMFMG	\$ 8,000	0	\$ 7,500	Alfa Laval										4
1	400-HE-09	400	HE	09	Heater and Cooling System	SX Feed Intercooler-MMFMG	\$ 8,000	0	\$ 7,500	Alfa Laval										4
1	400-HE-10	400	HE	10	Heater and Cooling System	SX Feed Intercooler-MMFMG	\$ 8,000	0	\$ 7,500	Alfa Laval										4
2	400-ME-01-02	400	ME	01-02	Crane		\$ 300,000	0	\$ 190,000											6
1	400-PK-01	400	PK	01	Cooper Sulfate Crystalliser Vendor Package		\$ 1,250,000	0	\$ 1,250,000				150	0.85	128					6
1	400-PK-02	400	PK	02	Copper Sulfate Packaging Package		\$ 400,000	0	\$ 400,000		8		30	0.85	43					
1	400-PP-01	400	PP	01	pH Adjustment Tank Pump (Duty)	MC 200-355	\$ 136,000	239	\$ 135,200	Weir	4638	m <sup>3</sup> /h	239	0.75	179	402	m <sup>3</sup> /h	55	\$ 31,170	2
1	400-PP-02	400	PP	02	pH Adjustment Tank Pump (Standby)	MC 200-355	\$ 136,000	239	\$ 135,200	Weir	4638	m <sup>3</sup> /h	239	0.00	0	402	m <sup>3</sup> /h	55	\$ 31,170	2
1	400-PP-03	400	PP	03	Thickener Underflow Pump (Duty)	MC 200-355	\$ 4,000	6	\$ 3,545	Weir	11	m <sup>3</sup> /h	6	0.75	5	402	m <sup>3</sup> /h	55	\$ 31,170	2
1	400-PP-04	400	PP	04	Thickener Underflow Pump (Standby)	MC 200-355	\$ 4,000	6	\$ 3,545	Weir	11	m <sup>3</sup> /h	6	0.00	0	402	m <sup>3</sup> /h	55	\$ 31,170	2
1	400-PP-05	400	PP	05	Filtrate Recycling Pump (Duty)	MC 200-355	\$ 3,000	5	\$ 2,952	Weir	8	m <sup>3</sup> /h	5	0.75	4	402	m <sup>3</sup> /h	55	\$ 31,170	2
1	400-PP-06	400	PP	06	Filtrate Recycling Pump (Standby)	MC 200-355	\$ 3,000	5	\$ 2,952	Weir	8	m <sup>3</sup> /h	5	0.00	0	402	m <sup>3</sup> /h	55	\$ 31,170	2
1	400-PP-07	400	PP	07	Polishing Filter Pump (Duty)	MC 200-355	\$ 136,000	238	\$ 135,062	Weir	4630	m <sup>3</sup> /h	238	0.75	179	402	m <sup>3</sup> /h	55	\$ 31,170	2
1	400-PP-08	400	PP	08	Polishing Filter Pump (Standby)	MC 200-355	\$ 136,000	238	\$ 135,062	Weir	4630	m <sup>3</sup> /h	238	0.00	0	402	m <sup>3</sup> /h	55	\$ 31,170	2
1	400-PP-09	400	PP	09	Copper SX PLS Feed Pump (Duty)	MC 200-355	\$ 136,000	238	\$ 135,062	Weir	4630	m <sup>3</sup> /h	238	0.75	179	402	m <sup>3</sup> /h	55	\$ 31,170	2
1	400-PP-10	400	PP	10	Copper SX PLS Feed Pump (Standby)	MC 200-355	\$ 136,000	238	\$ 135,062	Weir	4630	m <sup>3</sup> /h	238	0.00	0	402	m <sup>3</sup> /h	55	\$ 31,170	2
1	400-PP-11	400	PP	11	Organic Transfer Pump (Duty)	MC 200-355	\$ 136,000	238	\$ 135,062	Weir	4630	m <sup>3</sup> /h	238	0.75	179	402	m <sup>3</sup> /h	55	\$ 31,170	2
1	400-PP-12	400	PP	12	Organic Transfer Pump (Standby)	MC 200-355	\$ 136,000	238	\$ 135,062	Weir	4630	m <sup>3</sup> /h	238	0.00	0	402	m <sup>3</sup> /h	55	\$ 31,170	2
1	400-PP-13	400	PP	13	Cooper Extraction Crud Transfer Pump (Duty)	Peristaltic Pump	\$ 6,000	1	\$ 5,404	Flowrex	1	m <sup>3</sup> /h	1	0.75	1	0.53	m <sup>3</sup> /h	0.75	\$ 3,692	2
1	400-PP-14	400	PP	14	Cooper Extraction Crud Transfer Pump (Standby)	Peristaltic Pump	\$ 6,000	1	\$ 5,404	Flowrex	1	m <sup>3</sup> /h	1	0.00	0	0.53	m <sup>3</sup> /h	0.75	\$ 3,692	2
1	400-PP-15	400	PP	15	Raffinate Pump (Duty)	MC 200-355	\$ 136,000	238	\$ 135,062	Weir	4630	m <sup>3</sup> /h	238	0.75	179	402	m <sup>3</sup> /h	55	\$ 31,170	2
1	400-PP-16	400	PP	16	Raffinate Pump (Standby)	MC 200-355	\$ 136,000	238	\$ 135,062	Weir	4630	m <sup>3</sup> /h	238	0.00	0	402	m <sup>3</sup> /h	55	\$ 31,170	2
1	400-PP-17	400	PP	17	Loaded Organic Pump (Duty)	MC 200-355	\$ 136,000	130	\$ 135,062	Weir	4630	m <sup>3</sup> /h	130	0.75	98	402	m <sup>3</sup> /h	30	\$ 31,170	2
1	400-PP-18	400	PP	18	Loaded Organic Pump (Standby)	MC 200-355	\$ 136,000	130	\$ 135,062	Weir	4630	m <sup>3</sup> /h	130	0.00	0	402	m <sup>3</sup> /h	30	\$ 31,170	2
1	400-PP-19	400	PP	19	Cooper Extraction Crud Transfer Pump (Duty)	Peristaltic Pump	\$ 6,000	1	\$ 5,404	Flowrex	1	m <sup>3</sup> /h	1	0.75	1	0.53	m <sup>3</sup> /h	0.75	\$ 3,692	2
1	400-PP-20	400	PP	20	Cooper Extraction Crud Transfer Pump (Standby)	Peristaltic Pump	\$ 6,000	1	\$ 5,404	Flowrex	1	m <sup>3</sup> /h	1	0.00	0	0.53	m <sup>3</sup> /h	0.75	\$ 3,692	2
1	400-PP-21	400	PP	21	Raffinate Pump (Duty)	GEKONORM NM 32-160	\$ 49,000	33	\$ 48,009	Weir	4630	m <sup>3</sup> /h	33	0.75	24	402	m <sup>3</sup> /h	7.5	\$ 11,080	2
1	400-PP-22	400	PP	22	Raffinate Pump (Standby)	GEKONORM NM 32-160	\$ 49,000	33	\$ 48,009	Weir	4630	m <sup>3</sup> /h	33	0.00	0	402	m <sup>3</sup> /h	7.5	\$ 11,080	2
1	400-PP-23	400	PP	23	Loaded Organic Pump (Duty)	MC 200-355	\$ 136,000	130	\$ 135,062	Weir	4630	m <sup>3</sup> /h	130	0.75	98	402	m <sup>3</sup> /h	30	\$ 31,170	2
1	400-PP-24	400	PP	24	Loaded Organic Pump (Standby)	MC 200-355	\$ 136,000	130	\$ 135,062	Weir	4630	m <sup>3</sup> /h	130	0.00	0	402	m <sup>3</sup> /h	30	\$ 31,170	2
1	400-PP-25	400	PP	25	Stripping Feed Pump (Duty)	MC 200-355	\$ 136,000	238	\$ 135,062	Weir	4630	m <sup>3</sup> /h	238	0.75	179	402	m <sup>3</sup> /h	55	\$ 31,170	2
1	400-PP-26	400	PP	26	Stripping Feed Pump (Standby)	MC 200-355	\$ 136,000	238	\$ 135,062	Weir	4630	m <sup>3</sup> /h	238	0.00	0	402	m <sup>3</sup> /h	55	\$ 31,170	2
1	400-PP-27	400	PP	27	Stripping Liquor Pump (Duty)	GEKONORM NM 32-160	\$ 6,000	6	\$ 5,786	Weir	273	m <sup>3</sup> /h	6	0.75	4	402	m <sup>3</sup> /h	7.5	\$ 11,080	2
1	400-PP-28	400	PP	28	Stripping Liquor Pump (Standby)	GEKONORM NM 32-160	\$ 6,000	6	\$ 5,786	Weir	273	m <sup>3</sup> /h	6	0.00	0	402	m <sup>3</sup> /h	7.5	\$ 11,080	2
1	400-PP-29	400	PP	29	Cooper Stripping Crud Transfer Pump (Duty)	Peristaltic Pump	\$ 6,000	1	\$ 5,404	Flowrex	1	m <sup>3</sup> /h	1	0.75	1	0.53	m <sup>3</sup> /h	0.75	\$ 3,692	2
1	400-PP-30	400	PP	30	Cooper Stripping Crud Transfer Pump (Standby)	Peristaltic Pump	\$ 6,000	1	\$ 5,404	Flowrex	1	m <sup>3</sup> /h	1	0.00	0	0.53	m <sup>3</sup> /h	0.75	\$ 3,692	2
1	400-PP-31	400	PP	31	Loaded Stripping Solution Transfer Pump (Duty)	MC 200-355	\$ 25,000	44	\$ 24,701	Weir	273	m <sup>3</sup> /h	44	0.75	18	402	m <sup>3</sup> /h	30	\$ 31,170	2
1	400-PP-32	400	PP	32	Loaded Stripping Solution Transfer Pump (Standby)	MC 200-355	\$ 25,000	44	\$ 24,701	Weir	273	m <sup>3</sup> /h	44	0.00	0	402	m <sup>3</sup> /h	30	\$ 31,170	2
1	400-PP-33	400	PP	33	Barren Organic Pump (Duty)	GEKONORM NM 32-160	\$ 49,000	33	\$ 48,009	Weir	4630	m <sup>3</sup> /h	33	0.75	24	402	m <sup>3</sup> /h	7.5	\$ 11,080	2
1	400-PP-34	400	PP	34	Barren Organic Pump (Standby)	GEKONORM NM 32-160	\$ 49,000	33	\$ 48,009	Weir	4630	m <sup>3</sup> /h	33	0.00	0	402	m <sup>3</sup> /h	7.5	\$ 11,080	2
1	400-PP-35	400	PP	35	Cooper Stripping Crud Transfer Pump (Duty)	Peristaltic Pump	\$ 6,000	1	\$ 5,404	Flowrex	1	m <sup>3</sup> /h	1	0.75	1	0.53	m <sup>3</sup> /h	0.75	\$ 3,692	2
1	400-PP-36	400	PP	36	Cooper Stripping Crud Transfer Pump (Standby)	Peristaltic Pump	\$ 6,000	1	\$ 5,404	Flowrex	1	m <sup>3</sup> /h	1	0.00	0	0.53	m <sup>3</sup> /h	0.75	\$ 3,692	2
1	400-PP-37	400	PP	37	Loaded Aqueous Pump (Duty)	MC 200-355	\$ 25,000	44	\$ 24,701	Weir	273	m <sup>3</sup> /h	44	0.75	33	402	m <sup>3</sup> /h	55	\$ 31,170	2
1	400-PP-38	400	PP	38	Loaded Aqueous Pump (Standby)	MC 200-355	\$ 25,000	44	\$ 24,701	Weir	273	m <sup>3</sup> /h	44	0.00	0	402	m <sup>3</sup> /h	55	\$ 31,170	2
1	400-PP-39	400	PP	39	Stripped Organic Pump (Duty)	Peristaltic Pump	\$ 81,000	13	\$ 80,120	Weir	4630	m <sup>3</sup> /h	13	0.75	10	75	m <sup>3</sup> /h	1.1	\$ 6,752	2
1	400-PP-40	400	PP	40	Stripped Organic Pump (Standby)	Peristaltic Pump	\$ 81,000	13	\$ 80,120	Weir	4630	m <sup>3</sup> /h	13	0.00	0	75	m <sup>3</sup> /h	1.1	\$ 6,752	2



Quantity	Equipment Number	Area Number	Equipment	Tag	Description	Model/Type (equivalent or similar)	Equipment Price (USD)	Estimated Power (KW)	Scaled Cost USD	Supplier	Scaled Capacity	Units	Scaled Power (KW)	Diversity	Diversified Power (KW)	Basis Capacity	Units	Basis Power (KW)	Basis Cost (USD)	Reference
1	700-PP-26	700	PP	26	LIX Metering Pump (Standby)		\$ 8,800	1	\$ 8,800	Allied Colloids	70	L	1.0	0.00	0					2
1	700-PP-27	700	PP	27	Kerosene Metering Pump (Duty)	Mono B021 in 316 S.S.	\$ 13,000	1	\$ 13,000	Challenge	473	L	1.0	0.75	1					2
1	700-PP-28	700	PP	28	Kerosene Metering Pump (Standby)	Mono B021 in 316 S.S.	\$ 13,000	1	\$ 13,000	Challenge	473	L	1.0	0.00	0					2
1	700-PP-29	700	PP	29	Kerosene Metering Pump (Duty)	Mono B021 in 316 S.S.	\$ 13,000	1	\$ 13,000	Challenge	473	L	1.0	0.75	1					2
1	700-PP-30	700	PP	30	Kerosene Metering Pump (Standby)	Mono B021 in 316 S.S.	\$ 13,000	1	\$ 13,000	Challenge	473	L	1.0	0.00	0					2
1	700-PS-01	700	PS	01	Lime Sump Pump		\$ 12,000	0	\$ 11,106											4
1	700-PS-02	700	PS	02	Limestone Sump Pump		\$ 12,000	0	\$ 11,106											4
1	700-PS-03	700	PS	03	Acid Sump Pump		\$ 12,000	0	\$ 11,106											4
1	700-PS-04	700	PS	04	LIX Sump Pump		\$ 12,000	0	\$ 11,106											4
1	700-PS-05	700	PS	05	Guar Gum Sump Pump		\$ 12,000	0	\$ 11,106											4
1	700-PS-06	700	PS	06	Cobalt Sulphate Sump Pump		\$ 12,000	0	\$ 11,106											4
1	700-PS-07	700	PS	07	Kerosene Sump Pump		\$ 12,000	0	\$ 11,106											4
1	700-PS-08	700	PS	08	Polyacrylamide Sump Pump		\$ 12,000	0	\$ 11,106											4
1	700-PS-09	700	PS	09	Flocculant Sump Pump		\$ 12,000	0	\$ 11,106											4
1	700-SH-01	700	SH	01	Safety Shower & Eye Wash Station		\$ 4,000	0	\$ 4,000											4
1	700-SH-02	700	SH	02	Safety Shower & Eye Wash Station		\$ 4,000	0	\$ 4,000											4
1	700-SH-03	700	SH	03	Safety Shower & Eye Wash Station		\$ 4,000	0	\$ 4,000											4
1	700-SHD-01	700	SHD	01	Reagent Shed	12x32x6 (w x l x h)	\$ 160,000	0	\$ 160,000											6
1	700-TK-01	700	TK	01	Lime Slurry Distribution Tank	Steel Tank c/w liner, colour bond finish	\$ 12,000	0	\$ 11,316	Pioneer	8	m <sup>3</sup>				50	m <sup>3</sup>		\$ 33,000	2
1	700-TK-02	700	TK	02	Limestone Slurry Distribution Tank	Steel Tank c/w liner, colour bond finish	\$ 26,000	0	\$ 25,998	Pioneer	34	m <sup>3</sup>				50	m <sup>3</sup>		\$ 33,000	2
1	700-TK-03	700	TK	03	Acid Storage Tank	Steel Tank c/w liner, colour bond finish	\$ 95,000	0	\$ 94,301	Pioneer	77	m <sup>3</sup>				390	m <sup>3</sup>		\$ 250,000	2
1	700-TK-04	700	TK	04	LIX Mixing Tank	Steel Tank c/w liner, colour bond finish	\$ 13,000	0	\$ 12,196	Pioneer	7.2	m <sup>3</sup>				34	m <sup>3</sup>		\$ 30,954	2
1	700-TK-05	700	TK	05	Kerosene Distribution Tank	Steel Tank c/w liner, colour bond finish	\$ 17,000	0	\$ 16,571	Pioneer	12	m <sup>3</sup>				34	m <sup>3</sup>		\$ 30,954	2





## DOCUMENT COVER SHEET

**CLIENT:** Deep-South Resources

**PROJECT TITLE:** Haib PEA

**PROJECT NO.:** J5329

**DOCUMENT TITLE:** OPEX-8.5 Mtpa @ 80% Cu Recovery + CuSO4

**DOCUMENT NO:** J5329-ES-CA-000-001

**Option Description:** Whole Ore Heap Leach

THIS DOCUMENT HAS BEEN PREPARED AND CHECKED IN ACCORDANCE WITH THE FOLLOWING WORK INSTRUCTIONS / CHECKLISTS TO THE NOMINATED CHECKING METHOD & LEVEL.				
CHECKING METHOD		CHECKING LEVEL		
WORK INSTRUCTION / CHECKLIST NO.		OR	CH	
NAME		DATE		
OR				
CH				

A	21/04/20	Issue as draft to client	DC		
A	8/04/20	Began populating updated layout	BM	LZ	
<b>Rev</b>	<b>Date</b>	<b>Revision</b>	<b>By</b>	<b>Ch'k</b>	<b>L.E.</b>



Title: OPEX 6.5 Mtpa @ 80% Cu Recovery + CuSO4  
 Document No.: J529-ES-CA-000-001  
 Project: Halib PEA  
 Client: Deep-South Resources  
 Date: 08-Apr-20  
 Rev: A  
 Option: Whole Ore Heap Leach  
 Accuracy: ± 30%  
 Comments:

Summary 1 - Cost per pound of copper produced (Based on Commodity)					
	Cost		Fixed %	Fixed Cost USD/a	Variable USD/a
	USD/a	USD/lb Cu Eq			
Power	\$8,358,605	\$0.16	15.0	\$1,253,791	\$7,104,814
Consumables	\$7,326,841	\$0.14	5.0	\$366,342	\$6,960,499
Reagents	\$24,523,449	\$0.46	0.0	\$0	\$24,523,449
Labour	\$4,930,792	\$0.09	100.0	\$4,930,792	\$0
Maintenance	\$2,596,166	\$0.05	15.0	\$384,925	\$2,161,241
Misc	\$1,200,000	\$0.02	100.0	\$1,200,000	\$0
<b>Total</b>	<b>\$48,905,653</b>	<b>\$0.93</b>	<b>16.6</b>	<b>\$8,135,850</b>	<b>\$40,770,003</b>

Summary 1 - Cost per tonne of concentrate (Based on Commodity)					
	Cost		Fixed Cost USD/a	Variable USD/a	Overall Distribution %
	USD/a	USD/lb ROM			
Power	\$8,358,605	\$0.98	\$7,104,814	\$1,253,791	17.1
Consumables	\$7,326,841	\$0.86	\$366,342	\$6,960,499	15.0
Reagents	\$24,523,449	\$2.89	\$0	\$24,523,449	50.1
Labour	\$4,930,792	\$0.58	\$4,930,792	\$0	10.1
Maintenance	\$2,596,166	\$0.30	\$384,925	\$2,161,241	5.2
Miscellaneous	\$1,200,000	\$0.14	\$1,200,000	\$0	2.5
<b>Total</b>	<b>\$48,905,653</b>	<b>\$5.75</b>	<b>\$8,135,850</b>	<b>\$40,770,003</b>	<b>100.0</b>

Reagents					
	Price USD/unit	Unit	Consumption (units/a)	Cost	
				USD/a	USD/l ROM
Sulphuric Acid	\$275	t	26725	\$7,349,248	0.86
Polyacrylamide	\$2,150	t	1240	\$2,666,453	0.31
USBDN	\$12,000	t	233	\$2,807,544	0.33
Quicklime	\$300	t	5902	\$2,036,228	0.24
Limestone	\$150	t	19786	\$3,858,255	0.45
Calcrete/Dolomite	\$13	t	0	\$0	0.00
Kerosene	\$550	t	1321	\$755,885	0.09
Raw Water	\$1	kL	1133660	\$1,020,264	0.12
Flocculant	\$2,150	t	51	\$109,181	0.01
Diesel	\$1	L	3923449	\$3,890,380	0.46
<b>Total</b>				<b>\$24,523,449</b>	<b>\$2.89</b>

Maintenance					
	Mechanical Capital USD	Maintenance %	Cost		
			USD/a	USD/l ROM	
Crushing	\$16,910,000	5%	\$845,500	\$0.10	
HPGR	\$12,991,000	5%	\$649,550	\$0.08	
Agglomeration and Heap Leaching	\$13,316,000	1%	\$133,160	\$0.02	
Copper SX, EW and Crystallisation	\$23,724,000	3%	\$711,720	\$0.08	
Iron Removal and Tailings	\$2,812,000	3%	\$84,360	\$0.01	
Process and Raw Water	\$1,516,000	1%	\$15,160	\$0.00	
Reagents and Raw Water	\$2,590,200	3%	\$77,706	\$0.01	
Services	\$1,633,000	3%	\$48,990	\$0.01	
<b>Total</b>	<b>\$75,494,200</b>	<b>3.40%</b>	<b>\$2,666,166</b>	<b>\$0.30</b>	

Plant Standby Cost				
	Assumptions and Bases	% of annual total cost	Standby Cost USD/a	Dist %
Power	Agitators, thickeners and lighting persist	15.0	\$1,253,791	15.4
Consumables	Air and water service costs persist	5.0	\$366,342	4.5
Reagents	No reagent consumption due to no throughput	0.0	\$0	0.0
Labour	All staff retain their positions	100.0	\$4,930,792	60.6
Maintenance	Operational equipment maintenance	15.0	\$384,925	4.7
Miscellaneous	Contract agreements	100.0	\$1,200,000	14.7
<b>Total</b>		<b>16.6</b>	<b>\$8,135,850</b>	<b>100.0</b>

Power						
	Installed kW	Utilisation %	kW Draw	Total kWh/a	Cost	
					USD/a	USD/l ROM
Crushing	3,666	70	2,566	15,736,517	\$1,327,596	\$0.16
HPGR	4,661	90	4,195	33,073,727	\$2,790,232	\$0.33
Agglomeration and Heap Leaching	2,057	98	2,016	17,306,192	\$1,460,020	\$0.17
Copper SX, EW and Crystallisation	4,055	90	3,650	26,775,921	\$2,427,662	\$0.29
Iron Removal and Tailings	202	90	182	1,434,560	\$121,025	\$0.01
Process and Raw Water	335	90	302	2,378,374	\$200,649	\$0.02
Reagents	30	90	27	215,561	\$18,186	\$0.00
Services	28	70	20	157,007	\$13,246	\$0.00
<b>Total</b>	<b>16,036</b>		<b>12,958</b>	<b>99,077,860</b>	<b>\$8,358,605</b>	<b>\$0.98</b>

Consumables					
	Unit	Price USD/unit	Consumption (units/a)	Cost	
				USD/a	USD/l ROM
Gyratory Crusher Liner - Mantle	set	\$200,000.00	2	\$400,000	\$36,000 \$0.05
Gyratory Crusher Liner - Concave	set	\$200,000.00	4	\$800,000	\$72,000 \$0.10
Cone Crusher Liners - Bowl	set	\$18,000.00	6	\$108,000	\$9,720 \$0.01
Cone Crusher Liners - Mantle	set	\$18,000.00	6	\$108,000	\$9,720 \$0.01
Secondary Screen	set	\$200,000.00	8	\$1,600,000	\$14,400 \$0.02
HPGR Liner and Plates	set	\$1,149,512.00	1	\$574,756	\$51,728 \$0.07
HPGR Double Deck Screen Liner	set	\$25,000.00	16	\$400,000	\$36,000 \$0.05
Pad Clearance	m2	\$0.65	150640	\$98,046	\$0.01
Pad Earthworks	m3	\$2.50	268610	\$671,525	\$0.08
Pad Liner	m2	\$8.40	150640	\$1,267,056	\$114,035 \$0.16
Irrigation Tubing	m	\$7.00	5384	\$37,688	\$3,362 \$0.00
Replacement Cathodes	set	\$169.00	530	\$79,930	\$7,155 \$0.01
Replacement Anodes	set	\$200.00	663	\$132,500	\$11,925 \$0.02
Copper Sulfate Bags	each	\$12.50	51081	\$638,511	\$57,466 \$0.08
Copper Sulfate Pallets	each	\$15.00	51081	\$766,215	\$68,959 \$0.10
Oil	l	\$900.00	394	\$354,167	\$31,875 \$0.05
Grease	l	\$450.00	394	\$177,083	\$15,938 \$0.02
Air Filters	set	\$3,745.28	1	\$1,873	\$169 \$0.00
Mobile Lighting Tower Parts	set	\$700.00	3	\$2,100	\$189 \$0.00
Light Vehicle Parts	set	\$350.00	6	\$2,100	\$189 \$0.00
Water Truck Parts	set	\$2,100.00	1	\$2,100	\$189 \$0.00
Forklift Parts	set	\$1,750.00	2	\$3,500	\$315 \$0.00
Ambulance Parts/Consumables	set	\$700.00	1	\$700	\$63 \$0.00
<b>Total</b>				<b>\$7,326,841</b>	<b>\$0.86</b>

Key Inputs and Outputs		
Plant Throughput dry	8,500,000	tpa
Utilisation (Crushing)	6,132	h/a
Utilisation (Grinding)	7,894	h/a
Plant Throughput dry	1,078	dph
Head Grade	0.310%	% Cu
Recovery	80	% Cu
Annual Production	7,690	t Cu
	16,954,471	lb Cu
	\$1,981	t CuSO4 SH2O
	112,613,875	lb CuSO4 SH2O
	52,780,705	Total lb Cu Eq
Power Cost	\$0.084	USD/kWh
Total Power	11.98	kWh/t
Abrasion Index	0.49	
Fixed Component	\$8,135,850	USD/a
Variable Component	\$40,770,003	USD/l ROM
Operating Cost Estimation	\$5.75	USD/l ROM
Operating Cost Estimation	\$0.93	USD/lb Cu Eq

Miscellaneous Costs Only		
	Cost	
	USD/a	USD/l ROM
Laboratory Costs	\$1,000,000	\$0.12
Contractors	\$100,000	\$0.01
Vehicle Fleet	\$100,000	\$0.01
<b>Total</b>	<b>\$1,200,000</b>	<b>\$0.14</b>

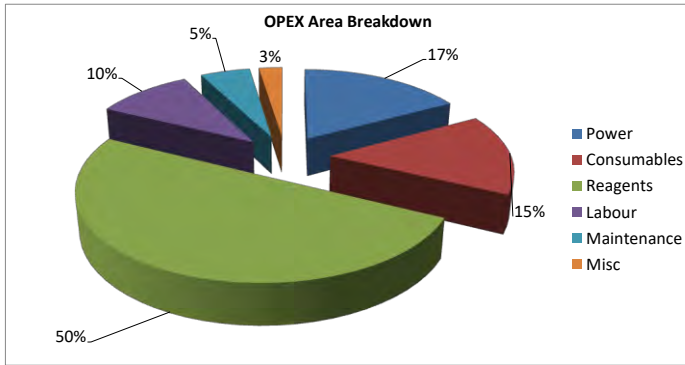

Rev	Date	Engineer	Comments
A	21/04/20	DC	Issue as draft to client
A	8/04/20	BM	Began populating updated layout



Key Input	Only Adjust variables in Blue	Source of information
Throughput (tph)	1078	Calculation
Throughput (tpe)	8,500,000	Basis value
Availability (Crushing)	70%	METS assumed value
Availability (Grinding)	90%	METS assumed value
Operating Hour pa (Crushing)	6132	Calculation
Operating Hour pa (Grinding)	7884	Calculation
Exchange rate (1 NAD = 0.07 USD)	\$0.07	<a href="http://www.xe.com">www.xe.com</a>

Price List	Units	Price USD/unit	Source of information
Gyratory Crusher Liner - Mantle	set	\$150,000	
Gyratory Crusher Liner - Concave	set	\$150,000	
Cone Crusher Liners - Bowl	set	\$18,000	
Cone Crusher Liners - Mantle	set	\$18,000	
Secondary Screen	set	\$20,000	
HPGR Liner and Plates	set	\$1,149,512	Koppers
HPGR Double Deck Screen Liner	set	\$25,000	
Pad Liner	m <sup>2</sup>	\$8.4	
Irrigation Tubing	m	\$7	
Oil	t	\$900	
Grease	t	\$450	
Air Filters	set	\$3,745	
Mobile Lighting Tower Parts	set	\$700	
Light Vehicle Parts	set	\$350	
Water Truck Parts	set	\$2,100	
Forklift Parts	set	\$1,750	
Ambulance Parts/Consumables	set	\$700	
Sulphuric Acid	t	\$275.00	DAP Noordoewer
Polyacrylamide	t	\$2,150.00	DAP Noordoewer
LIX984N	t	\$12,000	
Quicklime	t	\$300	
Limestone	t	\$150	
Calcrete/Dolomite	t	\$12.50	Assumption, mining cost+crushing cost
Kerosene	t	\$550	
Raw Water	kL	\$0.92	Calculation
Flocculant	t	\$2,150	DAP Noordoewer
Diesel	L	\$0.94	globalpetrolprices.com
Cathode	set	\$150.00	
Anode	set	\$200.00	
Power Cost (NS)	kWh	\$1.21	
Power Cost (US\$)	kWh	\$0.084	Calculation

\*Manipulation of the mass balance worksheet will automatically update the OPEX model



**Document** OPEX-8.5 Mtpa @ 80% Cu Recovery + CuSO4  
**Area** Labour  
**Client** Deep-South Resources  
**Project** Haib PEA  
**Job #** J5329  
**Doc #** J5329-ES-CA-000-001  
**Rev** A

Personnel	Annual Salary (N\$)	Annual Salary (USD)	Roster	Shift (D or D/N)	#	Total Cost (USD) per Annum	USD/t ROM	Crushing	Agglomeration and Heap Leaching	Copper SX, EW and Crystallisation	Iron Removal and Tailings	Process and Raw Water	Reagents	Services	
<b>Process Plant</b>															
General Manager	\$2,255,964	\$157,917	Full Time	D	1	\$157,917	\$0.02	\$0.01	\$0.00	\$0.00	\$0.00	\$0.00	\$0.00	\$0.00	
Personal Assistant	\$296,184	\$20,733	Full Time	D	1	\$20,733	\$0.00	\$0.00	\$0.00	\$0.00	\$0.00	\$0.00	\$0.00	\$0.00	
<b>Processing</b>															
Process Manager	\$1,253,128	\$87,719	Full Time	D	1	\$87,719	\$0.01	\$0.00	\$0.00	\$0.00	\$0.00	\$0.00	\$0.00	\$0.00	
Plant Superintendent/Supervisor	\$1,123,128	\$78,619	Full Time	D	1	\$78,619	\$0.01	\$0.00	\$0.00	\$0.00	\$0.00	\$0.00	\$0.00	\$0.00	
Shift Supervisor	\$1,123,128	\$78,619	Full Time	D	1	\$78,619	\$0.01	\$0.00	\$0.00	\$0.00	\$0.00	\$0.00	\$0.00	\$0.00	
Plant Operator	\$296,184	\$20,733	4/3 DIDO	D/N	44	\$912,247	\$0.11	\$0.03	\$0.03	\$0.02	\$0.02	\$0.01	\$0.01	\$0.01	
Day Crew / Cleanup	\$296,184	\$20,733	4/3 DIDO	D	4	\$82,932	\$0.01	\$0.00	\$0.00	\$0.00	\$0.00	\$0.00	\$0.00	\$0.00	
Senior Metallurgist	\$1,253,128	\$87,719	4/3 DIDO	D	2	\$175,438	\$0.02	\$0.01	\$0.01	\$0.00	\$0.00	\$0.00	\$0.00	\$0.00	
Metallurgist / Process Engineer	\$1,123,128	\$78,619	4/3 DIDO	D	2	\$157,238	\$0.02	\$0.01	\$0.00	\$0.00	\$0.00	\$0.00	\$0.00	\$0.00	
Graduate Metallurgist	\$691,452	\$48,402	4/3 DIDO	D	2	\$96,803	\$0.01	\$0.00	\$0.00	\$0.00	\$0.00	\$0.00	\$0.00	\$0.00	
Metallurgical Accounting Clerk	\$691,452	\$48,402	4/3 DIDO	D	2	\$96,803	\$0.01	\$0.00	\$0.00	\$0.00	\$0.00	\$0.00	\$0.00	\$0.00	
Electrical/Process Control Engineer	\$1,253,128	\$87,719	4/3 DIDO	D	2	\$175,438	\$0.02	\$0.01	\$0.01	\$0.00	\$0.00	\$0.00	\$0.00	\$0.00	
Chief Chemist	\$1,253,128	\$87,719	Full Time	D	1	\$87,719	\$0.01	\$0.00	\$0.00	\$0.00	\$0.00	\$0.00	\$0.00	\$0.00	
Chemist	\$691,452	\$48,402	4/3 DIDO	D	1	\$48,402	\$0.01	\$0.00	\$0.00	\$0.00	\$0.00	\$0.00	\$0.00	\$0.00	
Laboratory Technician	\$480,516	\$33,636	4/3 DIDO	D	2	\$67,272	\$0.01	\$0.00	\$0.00	\$0.00	\$0.00	\$0.00	\$0.00	\$0.00	
<b>Maintenance</b>															
Maintenance Manager	\$1,253,128	\$87,719	Full Time	D	1	\$87,719	\$0.01	\$0.00	\$0.00	\$0.00	\$0.00	\$0.00	\$0.00	\$0.00	
Reliability Engineer	\$976,536	\$68,358	Full Time	D	1	\$68,358	\$0.01	\$0.00	\$0.00	\$0.00	\$0.00	\$0.00	\$0.00	\$0.00	
Mechanical Supervisor	\$691,452	\$48,402	4/3 DIDO	D	2	\$96,803	\$0.01	\$0.00	\$0.00	\$0.00	\$0.00	\$0.00	\$0.00	\$0.00	
Fitter	\$480,516	\$33,636	4/3 DIDO	D	2	\$67,272	\$0.01	\$0.00	\$0.00	\$0.00	\$0.00	\$0.00	\$0.00	\$0.00	
Boilermaker	\$480,516	\$33,636	4/3 DIDO	D	2	\$67,272	\$0.01	\$0.00	\$0.00	\$0.00	\$0.00	\$0.00	\$0.00	\$0.00	
Fitter / Boilermaker Apprentice	\$296,184	\$20,732.88	4/3 DIDO	D	3	\$62,199	\$0.01	\$0.00	\$0.00	\$0.00	\$0.00	\$0.00	\$0.00	\$0.00	
Trades Assistant / Tool Storeman	\$338,772	\$23,714	4/3 DIDO	D	2	\$47,428	\$0.01	\$0.00	\$0.00	\$0.00	\$0.00	\$0.00	\$0.00	\$0.00	
Electrician	\$542,556	\$37,979	4/3 DIDO	D/N	4	\$151,916	\$0.02	\$0.01	\$0.00	\$0.00	\$0.00	\$0.00	\$0.00	\$0.00	
Instrumentation Technician	\$542,556	\$37,979	4/3 DIDO	D	2	\$75,958	\$0.01	\$0.00	\$0.00	\$0.00	\$0.00	\$0.00	\$0.00	\$0.00	
Electrical Apprentice	\$296,184	\$20,733	4/3 DIDO	D	1	\$20,733	\$0.00	\$0.00	\$0.00	\$0.00	\$0.00	\$0.00	\$0.00	\$0.00	
<b>Administration</b>															
Administration Manager	\$1,123,128	\$78,619	Full Time	D	1	\$78,619	\$0.01	\$0.00	\$0.00	\$0.00	\$0.00	\$0.00	\$0.00	\$0.00	
Senior Accountant	\$1,123,128	\$78,619	Full Time	D	1	\$78,619	\$0.01	\$0.00	\$0.00	\$0.00	\$0.00	\$0.00	\$0.00	\$0.00	
Reception and General Office	\$338,772	\$23,714	Full Time	D	1	\$23,714	\$0.00	\$0.00	\$0.00	\$0.00	\$0.00	\$0.00	\$0.00	\$0.00	
IT Officer	\$1,123,128	\$78,619	Full Time	D	1	\$78,619	\$0.01	\$0.00	\$0.00	\$0.00	\$0.00	\$0.00	\$0.00	\$0.00	
Shipping and Purchasing Officer	\$1,123,128	\$78,619	Full Time	D	1	\$78,619	\$0.01	\$0.00	\$0.00	\$0.00	\$0.00	\$0.00	\$0.00	\$0.00	
HR Superintendent	\$1,123,128	\$78,619	Full Time	D	1	\$78,619	\$0.01	\$0.00	\$0.00	\$0.00	\$0.00	\$0.00	\$0.00	\$0.00	
<b>Environmental and OH&amp;S</b>															
Environment, Health and Safety Manager	\$1,123,128	\$78,619	Full Time	D	1	\$78,619	\$0.01	\$0.00	\$0.00	\$0.00	\$0.00	\$0.00	\$0.00	\$0.00	
Environmental Officer	\$691,452	\$48,402	Full Time	D	1	\$48,402	\$0.01	\$0.00	\$0.00	\$0.00	\$0.00	\$0.00	\$0.00	\$0.00	
Safety and Training Co-ordinator	\$1,123,128	\$78,618.96	Full Time	D	1	\$78,619	\$0.01	\$0.00	\$0.00	\$0.00	\$0.00	\$0.00	\$0.00	\$0.00	
OH&S Technician	\$691,452	\$48,402	Full Time	D	1	\$48,402	\$0.01	\$0.00	\$0.00	\$0.00	\$0.00	\$0.00	\$0.00	\$0.00	
Emergency Response Co-ordinator	\$542,556	\$37,979	Full Time	D	1	\$37,979	\$0.00	\$0.00	\$0.00	\$0.00	\$0.00	\$0.00	\$0.00	\$0.00	
<b>On Costs -General</b>						\$1,152,407	\$0.14	\$0.04	\$0.03	\$0.02	\$0.02	\$0.01	\$0.01	\$0.01	
<b>On Costs - Messing</b>						\$0	\$0.00	\$0.00	\$0.00	\$0.00	\$0.00	\$0.00	\$0.00	\$0.00	
<b>% Split</b>								100%	30%	25%	15%	15%	5%	5%	
<b>Total</b>							<b>\$4,930,792</b>	<b>\$0.58</b>	<b>\$0.17</b>	<b>\$0.15</b>	<b>\$0.09</b>	<b>\$0.09</b>	<b>\$0.03</b>	<b>\$0.03</b>	<b>\$0.03</b>



**Document** OPEX-8.5 Mpa @ 80% Cu Recovery + CuSO4  
**Area** Consumables  
**Client** Deep-South Resources  
**Project** Halb PEA  
**Job #** J5329  
**Doc #** J5329-ES-CA-000-001  
**Rev** A

Concentrator Area/ Equipment Name	Cost (USD) per unit	Unit	Consumption Rate/Unit/Year	Number of Units	Total quantity per Year	Total Cost (USD) per Annum	Estimated Freight Cost	Total Cost (USD) per Annum	USD/t ROM
<b>Crushing</b>									
Gyratory Crusher Liner - Mantle	\$200,000	set	2	1	2	\$400,000	\$36,000	\$436,000	\$0.05
Gyratory Crusher Liner - Concave	\$200,000	set	4	1	4	\$800,000	\$72,000	\$872,000	\$0.10
Cone Crusher Liners - Bowl	\$18,000	set	3	2	6	\$108,000	\$9,720	\$117,720	\$0.01
Cone Crusher Liners - Mantle	\$18,000	set	3	2	6	\$108,000	\$9,720	\$117,720	\$0.01
Secondary Screen	\$20,000	set	4	2	8	\$160,000	\$14,400	\$174,400	\$0.02
HPGR Liner and Plates	\$1,149,512	set	0.3	2	0.5	\$574,756	\$51,728	\$626,484	\$0.07
HPGR Double Deck Screen Liner	\$25,000	set	8	2	16	\$400,000	\$36,000	\$436,000	\$0.05
<b>Sub total - Crushing and Grinding</b>						<b>\$2,550,756</b>	<b>\$229,568</b>	<b>\$2,780,324</b>	<b>\$0.33</b>
<b>Agglomeration and Heap Leaching</b>									
Pad Clearance	\$0.65	m2	150840	1	150840	\$98,046		\$98,046	\$0.01
Pad Earthworks	\$2.50	m3	268610	1	268610	\$671,525		\$671,525	\$0.08
Pad Liner	\$8.40	m2	150840	1	150840	\$1,267,058	\$114,035.18	\$1,381,093	\$0.16
Irrigation Tubing	\$7.00	m	1795	3	5384	\$37,685	\$3,392	\$41,076	\$0.00
<b>Sub total - Agglomeration and Heap Leach</b>						<b>\$2,074,313</b>	<b>\$117,427</b>	<b>\$2,191,740</b>	<b>\$0.26</b>
<b>Electrowinning</b>									
Replacement Cathodes	\$150	set	530	1	530	\$79,500	\$7,155	\$86,655	\$0.01
Replacement Anodes	\$200	set	663	1	663	\$132,500	\$11,925	\$144,425	\$0.02
Copper Sulfate Bags	\$13	each	51081	1	51081	\$638,511	\$57,466	\$695,977	\$0.08
Copper Sulfate Pallets	\$15	each	51081	1	51081	\$766,213	\$68,959	\$835,172	\$0.10
<b>Sub total - Electrowinning</b>						<b>\$1,616,723.52</b>	<b>\$145,505.12</b>	<b>\$1,762,228.63</b>	<b>\$0.21</b>
<b>Services</b>									
Oil	\$900	t	1.08	365	394	\$354,167	\$31,875	\$386,042	\$0.05
Grease	\$450	t	1.08	365	394	\$177,083	\$15,938	\$193,021	\$0.02
Air Filters	\$3,745	set	1	1	1	\$1,873	\$169	\$2,041	\$0.00
<b>Sub total - Services</b>						<b>\$533,123</b>	<b>\$47,981</b>	<b>\$581,104</b>	<b>\$0.07</b>
<b>Misc</b>									
Mobile Lighting Tower Parts	\$700	set	1	3	3	\$2,100	\$189	\$2,289	\$0.00
Light Vehicle Parts	\$350	set	1	6	6	\$2,100	\$189	\$2,289	\$0.00
Water Truck Parts	\$2,100	set	1	1	1	\$2,100	\$189	\$2,289	\$0.00
Forklift Parts	\$1,750	set	1	2	2	\$3,500	\$315	\$3,815	\$0.00
Ambulance Parts/Consumables	\$700	set	1	1	1	\$700	\$63	\$763	\$0.00
<b>Sub total - Misc</b>						<b>\$10,500</b>	<b>\$945</b>	<b>\$11,445</b>	<b>\$0.00</b>
<b>Total</b>						<b>\$6,785,415</b>	<b>\$541,426</b>	<b>\$7,326,841</b>	<b>\$0.86</b>



Document  
Area  
Client  
Project  
Job #  
Doc #  
Rev

OPEX-8.5 Mtpa @ 80% Cu Recovery + CuSO4  
Reagents  
Deep-South Resources  
Haib PEA  
J5329  
J5329-ES-CA-000-001  
A

Reagents	USD per unit CIF Luderitz	Unit	Consumed per Year	Reagent Cost (USD) per Annum	Transport Cost (USD) Port to Haib	Total Cost (USD) per Annum	USD/t ROM
Sulphuric Acid	\$275	t	26,725	7,349,248		\$7,349,248	\$0.86
Polyacrylamide	\$2,150	t	1,240	2,666,453		\$2,666,453	\$0.31
LIX984N	\$12,000	t	233	2,797,055	10,489	\$2,807,544	\$0.33
Quicklime	\$300	t	5,902	1,770,633	265,595	\$2,036,228	\$0.24
Limestone	\$150	t	19,786	2,967,889	890,367	\$3,858,255	\$0.45
Calcrete/Dolomite	\$12.50	t	0	0		\$0	\$0.00
Kerosene	\$550	t	1,321	726,457	59,437	\$785,895	\$0.09
Raw Water	\$0.92	kL	1,113,460	1,020,264		\$1,020,264	\$0.12
Flocculant	\$2,150	t	51	109,181		\$109,181	\$0.01
Diesel	\$0.94	L	3,923,449	3,680,195	210,185	\$3,890,380	\$0.46
<b>Total</b>						<b>\$24,523,449</b>	<b>\$2.89</b>

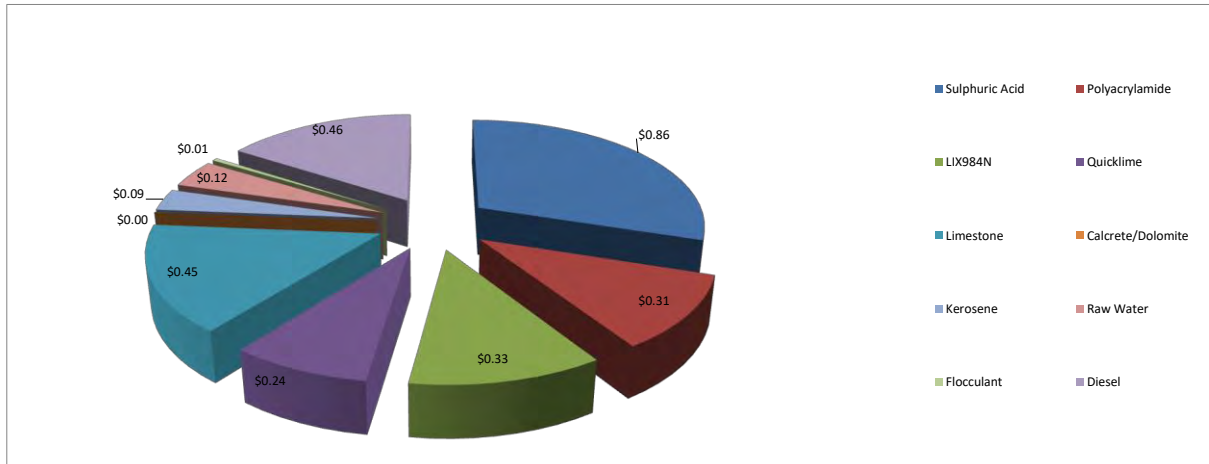



**Document** OPEX-8.5 Mtpa @ 80% Cu Recovery + CuSO4  
**Area** Power  
**Client** Deep-South Resources  
**Project** Haib PEA  
**Job #** J5329  
**Doc #** J5329-ES-CA-000-001  
**Rev** A

Concentrator Area/ Equipment Name	Installed Power (kW)	Utilisation %	Power Draw (kW)	Operating Hours	Consumption (kWhpa)	Total Cost (USD) per Annum	USD/t ROM
Crushing	3,666	70	2566	6,132	15,736,517	\$1,327,596	\$0.16
HPGR	4,661	90	4195	7,884	33,073,727	\$2,790,232	\$0.33
Agglomeration and Heap Leaching	2,057	98	2016	8,585	17,306,192	\$1,460,020	\$0.17
Copper SX, EW and Crystallisation	4,055	90	3650	7,884	28,775,921	\$2,427,652	\$0.29
Iron Removal and Tailings	202	90	182	7,884	1,434,560	\$121,025	\$0.01
Process and Raw Water	335	90	302	7,884	2,378,374	\$200,649	\$0.02
Reagents	30	90	27	7,884	215,561	\$18,186	\$0.00
Services	28	70	20	7,884	157,007	\$13,246	\$0.00
<b>Total</b>	<b>15,036</b>		<b>12,958</b>		<b>99,077,860</b>	<b>\$8,358,605</b>	<b>\$0.98</b>



**Document** OPEX-8.5 Mtpa @ 80% Cu Recovery + CuSO4  
**Area** Maintenance  
**Client** Deep-South Resources  
**Project** Haib PEA  
**Job #** J5329  
**Doc #** J5329-ES-CA-000-001  
**Rev** A

Area	Mechanical CAPEX (USD)	Maintenance Cost (%)	Maintenance Cost per year (USD)	USD/t ROM
Crushing	\$16,910,000	5%	\$845,500	\$0.10
HPGR	\$12,991,000	5%	\$649,550	\$0.08
Agglomeration and Heap Leaching	\$13,316,000	1%	\$133,160	\$0.02
Copper SX, EW and Crystallisation	\$23,724,000	3%	\$711,720	\$0.08
Iron Removal and Tailings	\$2,812,000	3%	\$84,360	\$0.01
Process and Raw Water	\$1,518,000	1%	\$15,180	\$0.00
Reagents	\$2,590,200	3%	\$77,706	\$0.01
Services	\$1,633,000	3%	\$48,990	\$0.01
<b>Total</b>	<b>\$75,494,200</b>		<b>\$2,566,166</b>	<b>\$0.30</b>

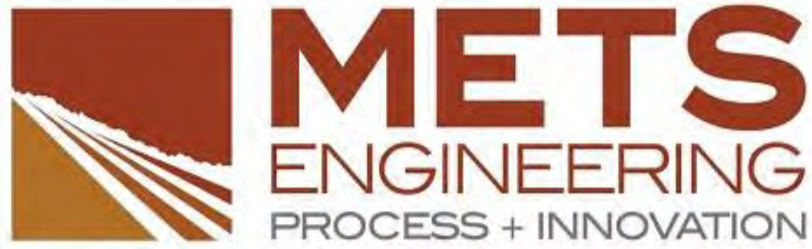

## DOCUMENT COVER SHEET

**CLIENT:** Deep-South Resources

**PROJECT TITLE:** Haib PEA

**PROJECT NO.:** J5329

**DOCUMENT TITLE:** OPEX-8.5 Mtpa @ 85% Cu Recovery

**DOCUMENT NO:** J5329-ES-CA-000-001

**Option Description:** Whole Ore Heap Leach

THIS DOCUMENT HAS BEEN PREPARED AND CHECKED IN ACCORDANCE WITH THE FOLLOWING WORK INSTRUCTIONS / CHECKLISTS TO THE NOMINATED CHECKING METHOD & LEVEL.			
CHECKING METHOD		CHECKING LEVEL	
WORK INSTRUCTION / CHECKLIST NO.	OR	CH	
NAME	DATE		
OR			
CH			

0	13/03/20	Issue as draft to client	DC		
A	10/01/20	Began populating updated layout	LZ	BM	
Rev	Date	Revision	By	Ch'k	L.E.





Title: OPEX-8.5 Mtpa @ 85% Cu Recovery  
 Document No.: J5329-ES-CA-000-001  
 Project: Haib PEA  
 Client: Deep-South Resources  
 Date: 00-Jan-00  
 Rev: A  
 Option: Whole Ore Heap Leach  
 Accuracy: ± 30%  
 Comments:

Summary 1 - Cost per pound of copper produced (Based on Commodity)					
	Cost		Fixed %	Fixed Cost USD/a	Variable Cost USD/a
	USD/a	USD/lb Cu Eq			
Power	\$10,712,307	\$0.22	15.0	\$1,606,846	\$9,105,461
Consumables	\$6,116,589	\$0.13	5.0	\$305,829	\$5,810,759
Reagents	\$17,812,870	\$0.37	0.0	\$0	\$17,812,870
Labour	\$4,930,792	\$0.10	100.0	\$4,930,792	\$0
Maintenance	\$2,599,126	\$0.05	15.0	\$389,869	\$2,209,257
Misc	\$1,200,000	\$0.03	100.0	\$1,200,000	\$0
<b>Total</b>	<b>\$43,371,684</b>	<b>\$0.91</b>	<b>19.4</b>	<b>\$8,433,337</b>	<b>\$34,938,348</b>

Summary 1 - Cost per tonne of Concentrate (Based on Commodity)					
	Cost		Fixed Cost USD/a	Variable Cost USD/a	Overall Distribution %
	USD/a	USD/t ROM			
Power	\$10,712,307	\$1.26	\$1,606,846	\$9,105,461	24.7
Consumables	\$6,116,589	\$0.72	\$305,829	\$5,810,759	14.1
Reagents	\$17,812,870	\$2.10	\$0	\$17,812,870	41.1
Labour	\$4,930,792	\$0.58	\$4,930,792	\$0	11.4
Maintenance	\$2,599,126	\$0.31	\$389,869	\$2,209,257	6.0
Miscellaneous	\$1,200,000	\$0.14	\$1,200,000	\$0	2.8
<b>Total</b>	<b>\$43,371,684</b>	<b>\$5.10</b>	<b>\$8,433,337</b>	<b>\$34,938,348</b>	<b>100.0</b>

Reagents					
	Price USD/unit	Unit	Consumption (unit/a)	Cost	
				USD/a	USD/t ROM
Sulphuric Acid	\$275	t	8044	\$2,212,002	0.26
Polyacrylamide	\$2,150	t	1247	\$2,680,015	0.32
LIX984N	\$12,000	t	233	\$2,807,544	0.33
Quicklime	\$300	t	6127	\$2,113,980	0.25
Limestone	\$150	t	28614	\$5,579,686	0.66
Calcrete/Dolomite	\$13	t	0	\$0	0.00
Kerosene	\$550	t	1321	\$785,895	0.09
Raw Water	\$1	kL	1007349	\$923,034	0.11
Flocculant	\$2,150	t	54	\$115,771	0.01
Diesel	\$1	L	600000	\$594,943	0.07
<b>Total</b>				<b>\$17,812,870</b>	<b>\$2.10</b>

Maintenance				
	Mechanical Capital USD	Maintenance %	Cost	
			USD/a	USD/t ROM
Crushing	\$16,910,000	5%	\$845,500	\$0.10
HPGR	\$12,991,000	5%	\$649,550	\$0.08
Agglomeration and Heap Leaching	\$13,316,000	1%	\$133,160	\$0.02
Copper SX and EW	\$25,020,000	3%	\$750,600	\$0.09
Iron Removal and Tailings	\$2,812,000	3%	\$84,360	\$0.01
Process and Raw Water	\$1,502,000	1%	\$15,020	\$0.00
Reagents	\$2,398,200	3%	\$71,946	\$0.01
Services	\$1,633,000	3%	\$48,990	\$0.01
<b>Total</b>	<b>\$76,582,200</b>	<b>3.39%</b>	<b>\$2,599,126</b>	<b>\$0.31</b>

Plant Standby Cost				
	Assumptions and Bases	% of annual total cost	Standby Cost USD/a	Dist %
Power	Agitators, thickeners and lighting persist	15.0	\$1,606,846	19.1
Consumables	Air and water service costs persist	5.0	\$305,829	3.6
Reagents	No reagent consumption due to no throughput	0.0	\$0	0.0
Labour	All staff retain their positions	100.0	\$4,930,792	58.5
Maintenance	Operational equipment maintenance	15.0	\$389,869	4.6
Miscellaneous	Contract agreements	100.0	\$1,200,000	14.2
<b>Total</b>		<b>19.4</b>	<b>\$8,433,337</b>	<b>100.0</b>

Power						
	Installed kW	Utilisation %	kW Draw	Total kWh/a	Cost	
					USD/a	USD/t ROM
Crushing	3,666	70	2,566	15,736,517	\$1,327,596	\$0.16
HPGR	4,661	90	4,195	33,073,727	\$2,790,232	\$0.33
Agglomeration and Heap Leaching	2,310	98	2,264	19,436,769	\$1,639,764	\$0.19
Copper SX and EW	7,699	90	6,929	54,629,811	\$4,608,789	\$0.54
Iron Removal and Tailings	202	90	182	1,434,560	\$121,025	\$0.01
Process and Raw Water	333	90	300	2,363,952	\$199,432	\$0.02
Reagents	20	90	18	144,889	\$12,223	\$0.00
Services	28	70	20	157,007	\$13,246	\$0.00
<b>Total</b>	<b>18,921</b>		<b>16,475</b>	<b>126,977,233</b>	<b>\$10,712,307</b>	<b>\$1.26</b>

Consumables						
	Unit	Price USD/unit	Consumption (unit/a)	Cost		
				USD/a	Freight	USD/t ROM
Gyratory Crusher Liner - Mantle	set	\$200,000.00	2	\$400,000	\$36,000	\$0.05
Gyratory Crusher Liner - Concave	set	\$200,000.00	4	\$800,000	\$72,000	\$0.10
Cone Crusher Liners - Bowl	set	\$18,000.00	6	\$108,000	\$9,720	\$0.01
Cone Crusher Liners - Mantle	set	\$18,000.00	6	\$108,000	\$9,720	\$0.01
Secondary Screen	set	\$20,000.00	8	\$160,000	\$14,400	\$0.02
HPGR Liner and Plates	set	\$1,149,512.00	1	\$574,756	\$51,728	\$0.07
HPGR Double Deck Screen Liner	set	\$25,000.00	16	\$400,000	\$36,000	\$0.05
Pad Clearance	m2	\$0.65	150840	\$98,046		\$0.01
Pad Earthworks	m3	\$2.50	268610	\$671,525		\$0.08
Pad Liner	m2	\$8.40	150840	\$1,267,058	\$114,035	\$0.16
Irrigation Tubing	m	\$7.00	5384	\$37,685	\$3,392	\$0.00
Replacement Cathodes	set	\$150.00	1266	\$189,900	\$17,091	\$0.02
Replacement Anodes	set	\$200.00	1583	\$316,500	\$28,485	\$0.04
Oil	t	\$900.00	394	\$354,167	\$31,875	\$0.05
Grease	t	\$450.00	394	\$177,083	\$15,938	\$0.02
Air Filters	set	\$3,745.28	1	\$1,873	\$169	\$0.00
Mobile Lighting Tower Parts	set	\$700.00	3	\$2,100	\$189	\$0.00
Light Vehicle Parts	set	\$350.00	6	\$2,100	\$189	\$0.00
Water Truck Parts	set	\$2,100.00	1	\$2,100	\$189	\$0.00
Forklift Parts	set	\$1,750.00	2	\$3,500	\$315	\$0.00
Ambulance Parts/Consumables	set	\$700.00	1	\$700	\$63	\$0.00
<b>Total</b>					<b>\$6,116,589</b>	<b>\$0.72</b>

Key Inputs and Outputs		
Plant Throughput dry	8,500,000	tpa
Utilisation (Crushing)	6,132	h/a
Utilisation (Grinding)	7,884	h/a
Plant Throughput dry	1,078	dtph
Head Grade	0.310%	% Cu
Recovery	0.0	% Cu
Annual Production	21,708	t Cu
	47,857,570	lb Cu
Power Cost	\$0.084	USD/kWh
Total Power	14.94	kWh/t
Abrasion Index	0.49	
Fixed Component	\$8,433,337	USD/a
Fixed Component	\$0.99	USD/t ROM
Variable Component	\$34,938,348	USD/a
Variable Component	\$4.11	USD/t ROM
<b>Operating Cost Estimation</b>	<b>\$5.10</b>	<b>USD/t ROM</b>
<b>Operating Cost Estimation</b>	<b>\$0.91</b>	<b>USD/lb Cu Eq</b>

Miscellaneous Costs Only		
	Cost	
	USD/a	USD/t ROM
Laboratory Costs	\$1,000,000	\$0.12
Contractors	\$100,000	\$0.01
Vehicle Fleet	\$100,000	\$0.01
<b>Total</b>	<b>\$1,200,000</b>	<b>\$0.14</b>

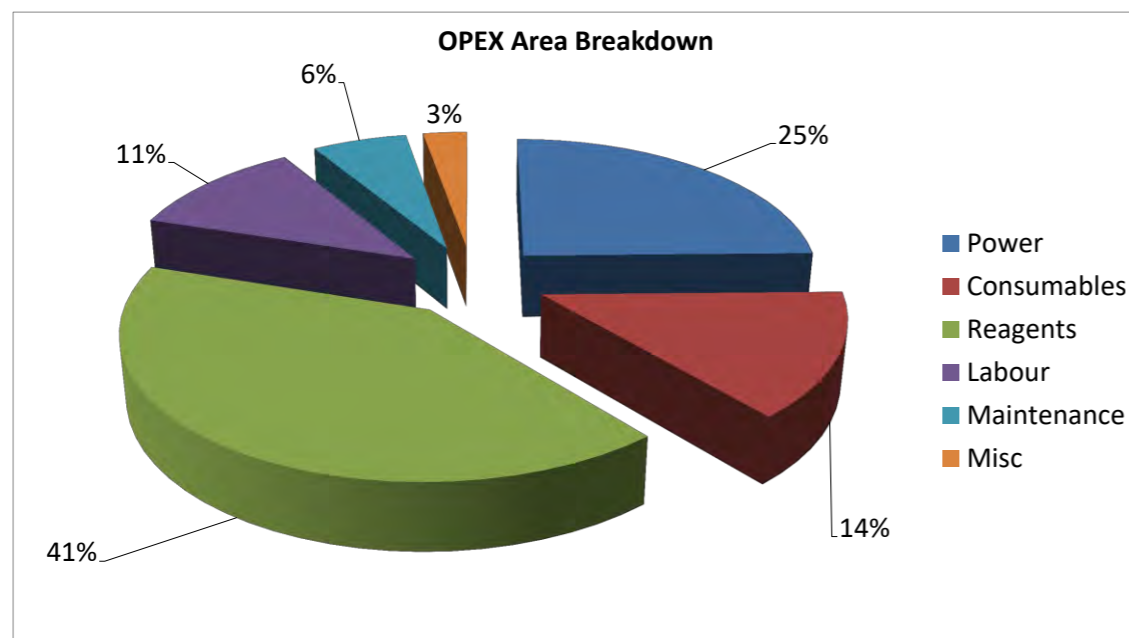

Rev	Date	Engineer	Comments
0	13/03/20	DC	Issue as draft to client
A	10/01/20	LZ	Began populating updated layout

Key Input	Only Adjust variables in Blue	Source of information
Throughput (tph)	1078	Calculation
Throughput (tpa)	8,500,000	Basis value
Availability (Crushing)	70%	METS assumed value
Availability (Grinding)	90%	METS assumed value
Operating Hour pa (Crushing)	6132	Calculation
Operating Hour pa (Grinding)	7884	Calculation
Exchange rate (1 NAD = 0.07 USD)	\$0.07	<a href="http://www.xe.com">www.xe.com</a>

Price List	Units	Price USD/unit	Source of information
Gyratory Crusher Liner - Mantle	set	\$150,000	
Gyratory Crusher Liner - Concave	set	\$150,000	
Cone Crusher Liners - Bowl	set	\$18,000	
Cone Crusher Liners - Mantle	set	\$18,000	
Secondary Screen	set	\$20,000	
HPGR Liner and Plates	set	\$1,149,512	Koppers
HPGR Double Deck Screen Liner	set	\$25,000	
Pad Liner	m <sup>2</sup>	\$8.4	
Irrigation Tubing	m	\$7	
Oil	t	\$900	
Grease	t	\$450	
Air Filters	set	\$3,745	
Mobile Lighting Tower Parts	set	\$700	
Light Vehicle Parts	set	\$350	
Water Truck Parts	set	\$2,100	
Forklift Parts	set	\$1,750	
Ambulance Parts/Consumables	set	\$700	
Sulphuric Acid	t	\$275.00	DAP Noordoewer
Polyacrylamide	t	\$2,150.00	DAP Noordoewer
LIX984N	t	\$12,000	
Quicklime	t	\$300	
Limestone	t	\$150	
Calcrete/Dolomite	t	\$12.50	Assumption, mining cost+crushing cost
Kerosene	t	\$550	
Raw Water	kL	\$0.92	Calculation
Flocculant	t	\$2,150	DAP Noordoewer
Diesel	L	\$0.94	<a href="http://globalpetrolprices.com">globalpetrolprices.com</a>
Cathode	set	\$150.00	
Anode	set	\$200.00	
Power Cost (N\$)	kWh	\$1.21	
Power Cost (US\$)	kWh	\$0.084	Calculation

\*Manipulation of the mass balance worksheet will automatically update the OPEX model



**Document** OPEX-8.5 Mtpa @ 85% Cu Recovery  
**Area** Labour  
**Client** Deep-South Resources  
**Project** Haib PEA  
**Job #** J5329  
**Doc #** J5329-ES-CA-000-001  
**Rev** A

Personnel	Annual Salary (N\$)	Annual Salary (USD)	Roster	Shift (D or D/N)	#	Total Cost (USD) per Annum	USD/t ROM	Crushing	Agglomeration and Heap Leaching	Copper SX and EW	Iron Removal and Tailings	Process and Raw Water	Reagents	Services	
<b>Process Plant</b>															
General Manager	\$2,255,964	\$157,917	Full Time	D	1	\$157,917	\$0.02	\$0.01	\$0.00	\$0.00	\$0.00	\$0.00	\$0.00	\$0.00	
Personal Assistant	\$296,184	\$20,733	Full Time	D	1	\$20,733	\$0.00	\$0.00	\$0.00	\$0.00	\$0.00	\$0.00	\$0.00	\$0.00	
<b>Processing</b>															
Process Manager	\$1,253,128	\$87,719	Full Time	D	1	\$87,719	\$0.01	\$0.00	\$0.00	\$0.00	\$0.00	\$0.00	\$0.00	\$0.00	
Plant Superintendent/Supervisor	\$1,123,128	\$78,619	Full Time	D	1	\$78,619	\$0.01	\$0.00	\$0.00	\$0.00	\$0.00	\$0.00	\$0.00	\$0.00	
Shift Supervisor	\$1,123,128	\$78,619	Full Time	D	1	\$78,619	\$0.01	\$0.00	\$0.00	\$0.00	\$0.00	\$0.00	\$0.00	\$0.00	
Plant Operator	\$296,184	\$20,733	4/3 DIDO	D/N	44	\$912,247	\$0.11	\$0.03	\$0.03	\$0.02	\$0.02	\$0.01	\$0.01	\$0.01	
Day Crew / Cleanup	\$296,184	\$20,733	4/3 DIDO	D	4	\$82,932	\$0.01	\$0.00	\$0.00	\$0.00	\$0.00	\$0.00	\$0.00	\$0.00	
Senior Metallurgist	\$1,253,128	\$87,719	4/3 DIDO	D	2	\$175,438	\$0.02	\$0.01	\$0.01	\$0.00	\$0.00	\$0.00	\$0.00	\$0.00	
Metallurgist / Process Engineer	\$1,123,128	\$78,619	4/3 DIDO	D	2	\$157,238	\$0.02	\$0.01	\$0.00	\$0.00	\$0.00	\$0.00	\$0.00	\$0.00	
Graduate Metallurgist	\$691,452	\$48,402	4/3 DIDO	D	2	\$96,803	\$0.01	\$0.00	\$0.00	\$0.00	\$0.00	\$0.00	\$0.00	\$0.00	
Metallurgical Accounting Clerk	\$691,452	\$48,402	4/3 DIDO	D	2	\$96,803	\$0.01	\$0.00	\$0.00	\$0.00	\$0.00	\$0.00	\$0.00	\$0.00	
Electrical/Process Control Engineer	\$1,253,128	\$87,719	4/3 DIDO	D	2	\$175,438	\$0.02	\$0.01	\$0.01	\$0.00	\$0.00	\$0.00	\$0.00	\$0.00	
Chief Chemist	\$1,253,128	\$87,719	Full Time	D	1	\$87,719	\$0.01	\$0.00	\$0.00	\$0.00	\$0.00	\$0.00	\$0.00	\$0.00	
Chemist	\$691,452	\$48,402	4/3 DIDO	D	1	\$48,402	\$0.01	\$0.00	\$0.00	\$0.00	\$0.00	\$0.00	\$0.00	\$0.00	
Laboratory Technician	\$480,516	\$33,636	4/3 DIDO	D	2	\$67,272	\$0.01	\$0.00	\$0.00	\$0.00	\$0.00	\$0.00	\$0.00	\$0.00	
<b>Maintenance</b>															
Maintenance Manager	\$1,253,128	\$87,719	Full Time	D	1	\$87,719	\$0.01	\$0.00	\$0.00	\$0.00	\$0.00	\$0.00	\$0.00	\$0.00	
Reliability Engineer	\$976,536	\$68,358	Full Time	D	1	\$68,358	\$0.01	\$0.00	\$0.00	\$0.00	\$0.00	\$0.00	\$0.00	\$0.00	
Mechanical Supervisor	\$691,452	\$48,402	4/3 DIDO	D	2	\$96,803	\$0.01	\$0.00	\$0.00	\$0.00	\$0.00	\$0.00	\$0.00	\$0.00	
Fitter	\$480,516	\$33,636	4/3 DIDO	D	2	\$67,272	\$0.01	\$0.00	\$0.00	\$0.00	\$0.00	\$0.00	\$0.00	\$0.00	
Boilermaker	\$480,516	\$33,636	4/3 DIDO	D	2	\$67,272	\$0.01	\$0.00	\$0.00	\$0.00	\$0.00	\$0.00	\$0.00	\$0.00	
Fitter / Boilermaker Apprentice	\$296,184	\$20,732.88	4/3 DIDO	D	3	\$62,199	\$0.01	\$0.00	\$0.00	\$0.00	\$0.00	\$0.00	\$0.00	\$0.00	
Trades Assisstant / Tool Storeman	\$338,772	\$23,714	4/3 DIDO	D	2	\$47,428	\$0.01	\$0.00	\$0.00	\$0.00	\$0.00	\$0.00	\$0.00	\$0.00	
Electrician	\$542,556	\$37,979	4/3 DIDO	D/N	4	\$151,916	\$0.02	\$0.01	\$0.00	\$0.00	\$0.00	\$0.00	\$0.00	\$0.00	
Instrumentation Technician	\$542,556	\$37,979	4/3 DIDO	D	2	\$75,958	\$0.01	\$0.00	\$0.00	\$0.00	\$0.00	\$0.00	\$0.00	\$0.00	
Electrical Apprentice	\$296,184	\$20,733	4/3 DIDO	D	1	\$20,733	\$0.00	\$0.00	\$0.00	\$0.00	\$0.00	\$0.00	\$0.00	\$0.00	
<b>Administration</b>															
Administration Manager	\$1,123,128	\$78,619	Full Time	D	1	\$78,619	\$0.01	\$0.00	\$0.00	\$0.00	\$0.00	\$0.00	\$0.00	\$0.00	
Senior Accountant	\$1,123,128	\$78,619	Full Time	D	1	\$78,619	\$0.01	\$0.00	\$0.00	\$0.00	\$0.00	\$0.00	\$0.00	\$0.00	
Reception and General Office	\$338,772	\$23,714	Full Time	D	1	\$23,714	\$0.00	\$0.00	\$0.00	\$0.00	\$0.00	\$0.00	\$0.00	\$0.00	
IT Officer	\$1,123,128	\$78,619	Full Time	D	1	\$78,619	\$0.01	\$0.00	\$0.00	\$0.00	\$0.00	\$0.00	\$0.00	\$0.00	
Shipping and Purchasing Officer	\$1,123,128	\$78,619	Full Time	D	1	\$78,619	\$0.01	\$0.00	\$0.00	\$0.00	\$0.00	\$0.00	\$0.00	\$0.00	
HR Superintendent	\$1,123,128	\$78,619	Full Time	D	1	\$78,619	\$0.01	\$0.00	\$0.00	\$0.00	\$0.00	\$0.00	\$0.00	\$0.00	
<b>Environmental and OH&amp;S</b>															
Environment, Health and Safety Manager	\$1,123,128	\$78,619	Full Time	D	1	\$78,619	\$0.01	\$0.00	\$0.00	\$0.00	\$0.00	\$0.00	\$0.00	\$0.00	
Environmental Officer	\$691,452	\$48,402	Full Time	D	1	\$48,402	\$0.01	\$0.00	\$0.00	\$0.00	\$0.00	\$0.00	\$0.00	\$0.00	
Safety and Training Co-ordinator	\$1,123,128	\$78,618.96	Full Time	D	1	\$78,619	\$0.01	\$0.00	\$0.00	\$0.00	\$0.00	\$0.00	\$0.00	\$0.00	
OH&S Technician	\$691,452	\$48,402	Full Time	D	1	\$48,402	\$0.01	\$0.00	\$0.00	\$0.00	\$0.00	\$0.00	\$0.00	\$0.00	
Emergency Response Co-ordinator	\$542,556	\$37,979	Full Time	D	1	\$37,979	\$0.00	\$0.00	\$0.00	\$0.00	\$0.00	\$0.00	\$0.00	\$0.00	
<b>On Costs -General</b>						\$1,152,407	\$0.14	\$0.04	\$0.03	\$0.02	\$0.02	\$0.01	\$0.01	\$0.01	
<b>On Costs - Messing</b>						\$0	\$0.00	\$0.00	\$0.00	\$0.00	\$0.00	\$0.00	\$0.00	\$0.00	
% Split								100%	30%	25%	15%	15%	5%	5%	
<b>Total</b>							<b>98</b>	<b>\$4,930,792</b>	<b>\$0.58</b>	<b>\$0.17</b>	<b>\$0.15</b>	<b>\$0.09</b>	<b>\$0.09</b>	<b>\$0.03</b>	<b>\$0.03</b>

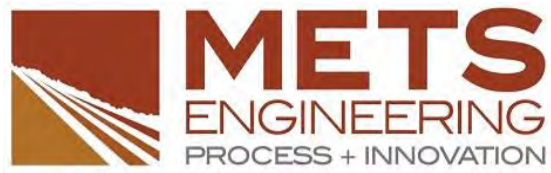

**Document** OPEX-8.5 Mtpa @ 85% Cu Recovery  
**Area** Consumables  
**Client** Deep-South Resources  
**Project** Haib PEA  
**Job #** J5329  
**Doc #** J5329-ES-CA-000-001  
**Rev** A

Concentrator Area/ Equipment Name	Cost (USD) per unit	Unit	Consumption Rate/Unit/Year	Number of Units	Total quantity per Year	Total Cost (USD) per Annum	Estimated Freight Cost	Total Cost (USD) per Annum	USD/t ROM
<b>Crushing</b>									
Gyratory Crusher Liner - Mantle	\$200,000	set	2	1	2	\$400,000	\$36,000	\$436,000	\$0.05
Gyratory Crusher Liner - Concave	\$200,000	set	4	1	4	\$800,000	\$72,000	\$872,000	\$0.10
Cone Crusher Liners - Bowl	\$18,000	set	3	2	6	\$108,000	\$9,720	\$117,720	\$0.01
Cone Crusher Liners - Mantle	\$18,000	set	3	2	6	\$108,000	\$9,720	\$117,720	\$0.01
Secondary Screen	\$20,000	set	4	2	8	\$160,000	\$14,400	\$174,400	\$0.02
HPGR Liner and Plates	\$1,149,512	set	0.3	2	0.5	\$574,756	\$51,728	\$626,484	\$0.07
HPGR Double Deck Screen Liner	\$25,000	set	8	2	16	\$400,000	\$36,000	\$436,000	\$0.05
<b>Sub total - Crushing and Grinding</b>						<b>\$2,550,756</b>	<b>\$229,568</b>	<b>\$2,780,324</b>	<b>\$0.33</b>
<b>Agglomeration and Heap Leaching</b>									
Pad Clearance	\$0.65	m2	150840	1	150840	\$98,046		\$98,046	\$0.01
Pad Earthworks	\$2.50	m3	268610	1	268610	\$671,525		\$671,525	\$0.08
Pad Liner	\$8.40	m2	150840	1	150840	\$1,267,058	\$114,035.18	\$1,381,093	\$0.16
Irrigation Tubing	\$7.00	m	1795	3	5384	\$37,685	\$3,392	\$41,076	\$0.00
<b>Sub total - Agglomeration and Heap Leach</b>						<b>\$2,074,313</b>	<b>\$117,427</b>	<b>\$2,191,740</b>	<b>\$0.26</b>
<b>Electrowinning</b>									
Replacement Cathodes	\$150	set	1266	1	1266	\$189,900	\$17,091	\$206,991	\$0.02
Replacement Anodes	\$200	set	1583	1	1583	\$316,500	\$28,485	\$344,985	\$0.04
<b>Sub total - Electrowinning</b>						<b>\$506,400</b>	<b>\$45,576</b>	<b>\$551,976</b>	<b>\$0.06</b>
<b>Services</b>									
Oil	\$900	t	1.08	365	394	\$354,167	\$31,875	\$386,042	\$0.05
Grease	\$450	t	1.08	365	394	\$177,083	\$15,938	\$193,021	\$0.02
Air Filters	\$3,745	set	1	1	1	\$1,873	\$169	\$2,041	\$0.00
<b>Sub total - Services</b>						<b>\$533,123</b>	<b>\$47,981</b>	<b>\$581,104</b>	<b>\$0.07</b>
<b>Misc</b>									
Mobile Lighting Tower Parts	\$700	set	1	3	3	\$2,100	\$189	\$2,289	\$0.00
Light Vehicle Parts	\$350	set	1	6	6	\$2,100	\$189	\$2,289	\$0.00
Water Truck Parts	\$2,100	set	1	1	1	\$2,100	\$189	\$2,289	\$0.00
Forklift Parts	\$1,750	set	1	2	2	\$3,500	\$315	\$3,815	\$0.00
Ambulance Parts/Consumables	\$700	set	1	1	1	\$700	\$63	\$763	\$0.00
<b>Sub total - Misc</b>						<b>\$10,500</b>	<b>\$945</b>	<b>\$11,445</b>	<b>\$0.00</b>
<b>Total</b>						<b>\$5,675,092</b>	<b>\$441,497</b>	<b>\$6,116,589</b>	<b>\$0.72</b>



Document  
Area  
Client  
Project  
Job #  
Doc #  
Rev

OPEX-8.5 Mtpa @ 85% Cu Recovery  
Reagents  
Deep-South Resources  
Haib PEA  
J5329  
J5329-ES-CA-000-001  
A

Reagents	USD per unit CIF Luderitz	Unit	Consumed per Year	Reagent Cost (USD) per Annum	Transport Cost (USD) Port to Haib	Total Cost (USD) per Annum	USD/t ROM
Sulphuric Acid	\$275	t	8,044	2,212,002		\$2,212,002	\$0.26
Polyacrylamide	\$2,150	t	1,247	2,680,015		\$2,680,015	\$0.32
LIX984N	\$12,000	t	233	2,797,055	10,489	\$2,807,544	\$0.33
Quicklime	\$300	t	6,127	1,838,244	275,737	\$2,113,980	\$0.25
Limestone	\$150	t	28,614	4,292,066	1,287,620	\$5,579,686	\$0.66
Calcrete/Dolomite	\$12.50	t	0	0		\$0	\$0.00
Kerosene	\$550	t	1,321	726,457	59,437	\$785,895	\$0.09
Raw Water	\$0.92	kL	1,007,349	923,034		\$923,034	\$0.11
Flocculant	\$2,150	t	54	115,771		\$115,771	\$0.01
Diesel	\$0.94	L	600,000	562,800	32,143	\$594,943	\$0.07
<b>Total</b>						<b>\$17,812,870</b>	<b>\$2.10</b>

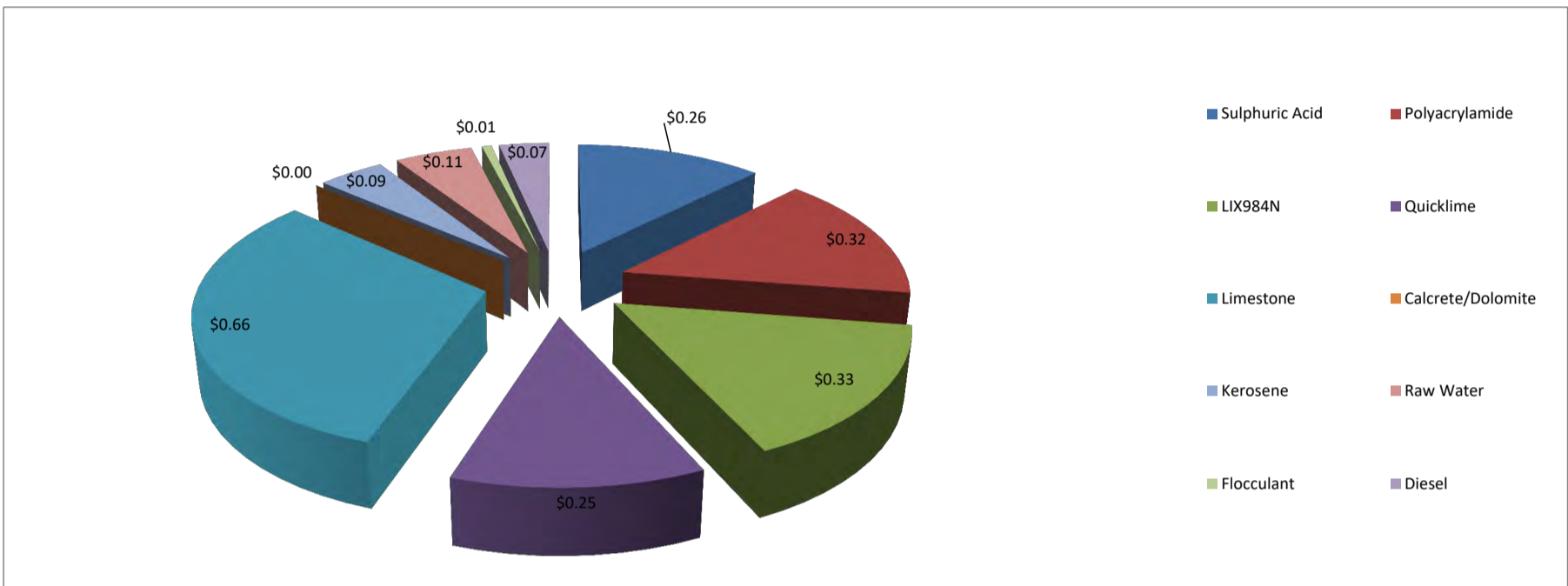



**Document** OPEX-8.5 Mtpa @ 85% Cu Recovery  
**Area** Power  
**Client** Deep-South Resources  
**Project** Haib PEA  
**Job #** J5329  
**Doc #** J5329-ES-CA-000-001  
**Rev** A

Concentrator Area/ Equipment Name	Installed Power (kW)	Utilisation %	Power Draw (kW)	Operating Hours	Consumption (kWHPa)	Total Cost (USD) per Annum	USD/t ROM
Crushing	3,666	70	2566	6,132	15,736,517	\$1,327,596	\$0.16
HPGR	4,661	90	4195	7,884	33,073,727	\$2,790,232	\$0.33
Agglomeration and Heap Leaching	2,310	98	2264	8,585	19,436,769	\$1,639,764	\$0.19
Copper SX and EW	7,699	90	6929	7,884	54,629,811	\$4,608,789	\$0.54
Iron Removal and Tailings	202	90	182	7,884	1,434,560	\$121,025	\$0.01
Process and Raw Water	333	90	300	7,884	2,363,952	\$199,432	\$0.02
Reagents	20	90	18	7,884	144,889	\$12,223	\$0.00
Services	28	70	20	7,884	157,007	\$13,246	\$0.00
<b>Total</b>	<b>18,921</b>		<b>16,475</b>		<b>126,977,233</b>	<b>\$10,712,307</b>	<b>\$1.26</b>



**Document** OPEX-8.5 Mtpa @ 85% Cu Recovery  
**Area** Maintenance  
**Client** Deep-South Resources  
**Project** Haib PEA  
**Job #** J5329  
**Doc #** J5329-ES-CA-000-001  
**Rev** A

Area	Mechanical CAPEX (USD)	Maintenance Cost (%)	Maintenance Cost per year (USD)	USD/t ROM
Crushing	\$16,910,000	5%	\$845,500	\$0.10
HPGR	\$12,991,000	5%	\$649,550	\$0.08
Agglomeration and Heap Leaching	\$13,316,000	1%	\$133,160	\$0.02
Copper SX and EW	\$25,020,000	3%	\$750,600	\$0.09
Iron Removal and Tailings	\$2,812,000	3%	\$84,360	\$0.01
Process and Raw Water	\$1,502,000	1%	\$15,020	\$0.00
Reagents	\$2,398,200	3%	\$71,946	\$0.01
Services	\$1,633,000	3%	\$48,990	\$0.01
<b>Total</b>	<b>\$76,582,200</b>		<b>\$2,599,126</b>	<b>\$0.31</b>



## DOCUMENT COVER SHEET

**CLIENT:** Deep-South Resources

**PROJECT TITLE:** Haib PEA

**PROJECT NO.:** J5329

**DOCUMENT TITLE:** OPEX-8.5 Mtpa @ 85% Cu Recovery +CuSO4

**DOCUMENT NO:** J5329-ES-CA-000-001

**Option Description:** Whole Ore Heap Leach

THIS DOCUMENT HAS BEEN PREPARED AND CHECKED IN ACCORDANCE WITH THE FOLLOWING WORK INSTRUCTIONS / CHECKLISTS TO THE NOMINATED CHECKING METHOD & LEVEL.				
CHECKING METHOD		CHECKING LEVEL		
WORK INSTRUCTION / CHECKLIST NO.		OR	CH	
NAME		DATE		
OR				
CH				

0	13/03/20	Issue as draft to client	DC		
A	6/03/20	Began populating updated layout	LZ	BM	
<b>Rev</b>	<b>Date</b>	<b>Revision</b>	<b>By</b>	<b>Ch'k</b>	<b>L.E.</b>





Title: OPEX-8.5 Mtpa @ 85% Cu Recovery +CuSO4  
 Document No.: J5329-ES-CA-000-001  
 Project: Haili PEA  
 Client: Deep-South Resources  
 Date: 06-Mar-20  
 Rev: A  
 Option: Whole Ore Heap Leach  
 Accuracy: ± 30%  
 Comments:

Key Inputs and Outputs			
Plant Throughput dry	8,500,000	tpa	
Utilisation (Crushing)	6.132	h/a	
Utilisation (Grinding)	7.884	h/a	
Plant Throughput dry	1,078	dtp/h	
Head Grade	0.310%	% Cu	
Recovery	85	% Cu	
Annual Production	8,967	t Cu	
	19,769,622	lb Cu	
	51,081	t CuSO4.5H2O	
	112,613,875	lb CuSO4.5H2O	
	55,995,856	Total lb Cu Eq	
Power Cost	\$0.084	USD/kWh	
Total Power	11.96	kWh/t	
Abrasion Index	0.49		
Fixed Component	\$8,170,659	USD/a	
Fixed Component	\$0.96	USD/t ROM	
Variable Component	\$42,774,881	USD/a	
Variable Component	\$5.03	USD/t ROM	
Operating Cost Estimation	\$5.99	USD/t ROM	
Operating Cost Estimation	\$0.92	USD/lb Cu Eq	

Miscellaneous Costs Only		
	Cost	
	USD/a	USD/t ROM
Laboratory Costs	\$1,000,000	\$0.12
Contractors	\$100,000	\$0.01
Vehicle Fleet	\$100,000	\$0.01
<b>Total</b>	<b>\$1,200,000</b>	<b>\$0.14</b>

Summary 1 - Cost per pound of copper produced (Based on Commodity)					
	Cost		Fixed %	Fixed Cost USD/a	Variable Cost USD/a
	USD/a	USD/lb Cu Eq			
Power	\$8,576,774	\$0.15	15.0	\$1,286,516	\$7,290,258
Consumables	\$7,326,841	\$0.13	5.0	\$366,342	\$6,960,499
Reagents	\$26,331,076	\$0.47	0.0	\$0	\$26,331,076
Labour	\$4,930,792	\$0.09	100.0	\$4,930,792	\$0
Maintenance	\$2,580,056	\$0.05	15.0	\$387,008	\$2,193,048
Misc	\$1,200,000	\$0.02	100.0	\$1,200,000	\$0
<b>Total</b>	<b>\$50,945,540</b>	<b>\$0.92</b>	<b>16.0</b>	<b>\$8,170,659</b>	<b>\$42,774,881</b>

Summary 1 - Cost per tonne of Concentrate (Based on Commodity)					
	Cost		Fixed Cost USD/a	Variable Cost USD/a	Overall Distribution %
	USD/a	USD/t ROM			
Power	\$8,576,774	\$1.01	\$1,286,516	\$7,290,258	16.8
Consumables	\$7,326,841	\$0.86	\$366,342	\$6,960,499	14.4
Reagents	\$26,331,076	\$3.10	\$0	\$26,331,076	51.7
Labour	\$4,930,792	\$0.58	\$4,930,792	\$0	9.7
Maintenance	\$2,580,056	\$0.30	\$387,008	\$2,193,048	5.1
Miscellaneous	\$1,200,000	\$0.14	\$1,200,000	\$0	2.4
<b>Total</b>	<b>\$50,945,540</b>	<b>\$5.99</b>	<b>\$8,170,659</b>	<b>\$42,774,881</b>	<b>100.0</b>

Reagents					
	Price USD/unit	Unit	Consumption (unit/a)	Cost	
				USD/a	USD/t ROM
Sulphuric Acid	\$275	t	26725	\$7,349,248	0.86
Polyacrylamide	\$2,150	t	1241	\$2,667,686	0.31
LIX84N	\$12,000	t	233	\$2,807,544	0.33
Quicklime	\$300	t	6127	\$2,113,980	0.25
Limestone	\$150	t	28614	\$5,579,686	0.66
Calcite/Dolomite	\$13	t	0	\$0	0.00
Kerosene	\$550	t	1321	\$735,895	0.09
Raw Water	\$1	kL	1114137	\$1,020,883	0.12
Flocculant	\$2,150	t	54	\$115,771	0.01
Diesel	\$1	L	3923449	\$3,890,380	0.46
<b>Total</b>				<b>\$26,331,076</b>	<b>\$3.10</b>

Maintenance					
	Mechanical Capital USD	Maintenance %	Cost		
			USD/a	USD/t ROM	
Crushing	\$16,910,000	5%	\$845,500	\$0.10	
HPGR	\$12,991,000	5%	\$649,550	\$0.08	
Agglomeration and Heap Leaching	\$13,316,000	1%	\$133,160	\$0.02	
Copper SX, EW and Crystallisation	\$24,187,000	3%	\$725,610	\$0.09	
Iron Removal and Tailings	\$2,812,000	3%	\$84,360	\$0.01	
Process and Raw Water	\$1,518,000	1%	\$15,180	\$0.00	
Reagents	\$2,590,200	3%	\$77,706	\$0.01	
Services	\$1,833,000	3%	\$48,990	\$0.01	
<b>Total</b>	<b>\$75,957,200</b>	<b>3.40%</b>	<b>\$2,580,056</b>	<b>\$0.30</b>	

Plant Standby Cost					
	Assumptions and Bases		% of annual total cost	Standby Cost USD/a	Dist %
Power	Agitators, thickeners and lighting persist		15.0	\$1,286,516	15.7
Consumables	Air and water service costs persist		5.0	\$366,342	4.5
Reagents	No reagent consumption due to no throughput		0.0	\$0	0.0
Labour	All staff retain their positions		100.0	\$4,930,792	60.3
Maintenance	Operational equipment maintenance		15.0	\$387,008	4.7
Miscellaneous	Contract agreements		100.0	\$1,200,000	14.7
<b>Total</b>			<b>16.0</b>	<b>\$8,170,659</b>	<b>100.0</b>

Power						
	Installed kW	Utilisation %	kW Draw	Total kWh/a	Cost	
					USD/a	USD/t ROM
Crushing	3,666	70	2,566	15,736,517	\$1,327,596	\$0.16
HPGR	4,661	90	4,195	33,073,727	\$2,790,232	\$0.33
Agglomeration and Heap Leaching	2,057	98	2,016	17,306,192	\$1,460,200	\$0.17
Copper SX, EW and Crystallisation	4,420	90	3,978	31,361,975	\$2,645,822	\$0.31
Iron Removal and Tailings	202	90	182	1,434,560	\$121,025	\$0.01
Process and Raw Water	335	90	302	2,378,374	\$200,649	\$0.02
Reagents	30	90	27	215,561	\$18,186	\$0.00
Services	28	70	20	157,007	\$13,246	\$0.00
<b>Total</b>	<b>15,400</b>		<b>13,286</b>	<b>101,663,914</b>	<b>\$8,576,774</b>	<b>\$1.01</b>

Consumables						
	Unit	Price USD/unit	Consumption (unit/a)	Cost		
				USD/a	Freight	USD/t ROM
Gyratory Crusher Liner - Mantle	set	\$200,000.00	2	\$400,000	\$36,000	\$0.05
Gyratory Crusher Liner - Concave	set	\$200,000.00	4	\$800,000	\$72,000	\$0.10
Cone Crusher Liners - Bowl	set	\$18,000.00	6	\$108,000	\$9,720	\$0.01
Cone Crusher Liners - Mantle	set	\$18,000.00	6	\$108,000	\$9,720	\$0.01
Secondary Screen	set	\$20,000.00	8	\$160,000	\$14,400	\$0.02
HPGR Liner and Plates	set	\$1,149,512.00	1	\$574,756	\$51,728	\$0.07
HPGR Double Deck Screen Liner	set	\$25,000.00	16	\$400,000	\$36,000	\$0.05
Pad Clearance	m2	\$0.85	156840	\$98,016	\$0.01	
Pad Earthworks	m3	\$2.50	269610	\$674,525	\$0.08	
Pad Liner	m2	\$8.40	150840	\$1,267,056	\$114,035	\$0.16
Irrigation Tubing	m	\$7.00	5384	\$37,885	\$3,392	\$0.00
Replacement Cathodes	set	\$150.00	530	\$79,500	\$7,155	\$0.01
Replacement Anodes	set	\$200.00	963	\$192,600	\$17,925	\$0.02
Copper Sulfate Bags	each	\$12.50	51081	\$638,511	\$57,466	\$0.08
Copper Sulfate Pellets	each	\$15.00	51081	\$766,215	\$68,959	\$0.10
Grease	t	\$900.00	394	\$354,167	\$31,875	\$0.05
Air Filters	set	\$3,745.28	1	\$1,873	\$169	\$0.00
Mobile Lighting Tower Parts	set	\$700.00	3	\$2,100	\$189	\$0.00
Light Vehicle Parts	set	\$350.00	6	\$2,100	\$189	\$0.00
Water Truck Parts	set	\$2,100.00	1	\$2,100	\$189	\$0.00
Forklift Parts	set	\$1,750.00	2	\$3,500	\$315	\$0.00
Ambulance Parts/Consumables	set	\$700.00	1	\$700	\$63	\$0.00
<b>Total</b>					<b>\$7,326,841</b>	<b>\$0.86</b>

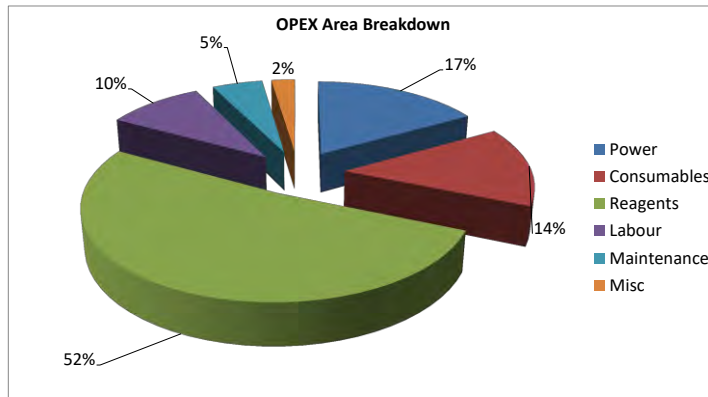

Rev	Date	Engineer	Comments
0	12/8/20	DC	Issue as draft to client
A	6/3/20	LZ	Begin population updated layout

Key Input	Only Adjust variables in Blue	Source of information
Throughput (tph)	1078	Calculation
Throughput (tpa)	8,500,000	Basis value
Availability (Crushing)	70%	METS assumed value
Availability (Grinding)	90%	METS assumed value
Operating Hour pa (Crushing)	6132	Calculation
Operating Hour pa (Grinding)	7884	Calculation
Exchange rate (1 NAD = 0.07 USD)	\$0.07	<a href="http://www.xe.com">www.xe.com</a>

Price List	Units	Price USD/unit	Source of information
Gyratory Crusher Liner - Mantle	set	\$150,000	
Gyratory Crusher Liner - Concave	set	\$150,000	
Cone Crusher Liners - Bowl	set	\$18,000	
Cone Crusher Liners - Mantle	set	\$18,000	
Secondary Screen	set	\$20,000	
HPGR Liner and Plates	set	\$1,149,512	Koppers
HPGR Double Deck Screen Liner	set	\$25,000	
Pad Liner	m <sup>2</sup>	\$8.4	
Irrigation Tubing	m	\$7	
Oil	t	\$900	
Grease	t	\$450	
Air Filters	set	\$3,745	
Mobile Lighting Tower Parts	set	\$700	
Light Vehicle Parts	set	\$350	
Water Truck Parts	set	\$2,100	
Forklift Parts	set	\$1,750	
Ambulance Parts/Consumables	set	\$700	
Sulphuric Acid	t	\$275.00	DAP Noordoewer
Polyacrylamide	t	\$2,150.00	DAP Noordoewer
LIX984N	t	\$12,000	
Quicklime	t	\$300	
Limestone	t	\$150	
Calcrete/Dolomite	t	\$12.50	Assumption, mining cost+crushing cost
Kerosene	t	\$550	
Raw Water	kL	\$0.92	Calculation
Flocculant	t	\$2,150	DAP Noordoewer
Diesel	L	\$0.94	<a href="http://globalpetrolprices.com">globalpetrolprices.com</a>
Cathode	set	\$150.00	
Anode	set	\$200.00	
Power Cost (N\$)	kWh	\$1.21	
Power Cost (US\$)	kWh	\$0.084	Calculation

\*Manipulation of the mass balance worksheet will automatically update the OPEX model



**Document** OPEX-8.5 Mtpa @ 85% Cu Recovery +CuSO4  
**Area** Labour  
**Client** Deep-South Resources  
**Project** Haib PEA  
**Job #** J5329  
**Doc #** J5329-ES-CA-000-001  
**Rev** A

Personnel	Annual Salary (N\$)	Annual Salary (USD)	Roster	Shift (D or D/N)	#	Total Cost (USD) per Annum	USD/t ROM	Crushing	Agglomeration and Heap Leaching	Copper SX, EW and Crystallisation	Iron Removal and Tailings	Process and Raw Water	Reagents	Services	
<b>Process Plant</b>															
General Manager	\$2,255,964	\$157,917	Full Time	D	1	\$157,917	\$0.02	\$0.01	\$0.00	\$0.00	\$0.00	\$0.00	\$0.00	\$0.00	
Personal Assistant	\$296,184	\$20,733	Full Time	D	1	\$20,733	\$0.00	\$0.00	\$0.00	\$0.00	\$0.00	\$0.00	\$0.00	\$0.00	
<b>Processing</b>															
Process Manager	\$1,253,128	\$87,719	Full Time	D	1	\$87,719	\$0.01	\$0.00	\$0.00	\$0.00	\$0.00	\$0.00	\$0.00	\$0.00	
Plant Superintendent/Supervisor	\$1,123,128	\$78,619	Full Time	D	1	\$78,619	\$0.01	\$0.00	\$0.00	\$0.00	\$0.00	\$0.00	\$0.00	\$0.00	
Shift Supervisor	\$1,123,128	\$78,619	Full Time	D	1	\$78,619	\$0.01	\$0.00	\$0.00	\$0.00	\$0.00	\$0.00	\$0.00	\$0.00	
Plant Operator	\$296,184	\$20,733	4/3 DIDO	D/N	44	\$912,247	\$0.11	\$0.03	\$0.03	\$0.02	\$0.02	\$0.01	\$0.01	\$0.01	
Day Crew / Cleanup	\$296,184	\$20,733	4/3 DIDO	D	4	\$82,932	\$0.01	\$0.00	\$0.00	\$0.00	\$0.00	\$0.00	\$0.00	\$0.00	
Senior Metallurgist	\$1,253,128	\$87,719	4/3 DIDO	D	2	\$175,438	\$0.02	\$0.01	\$0.01	\$0.00	\$0.00	\$0.00	\$0.00	\$0.00	
Metallurgist / Process Engineer	\$1,123,128	\$78,619	4/3 DIDO	D	2	\$157,238	\$0.02	\$0.01	\$0.00	\$0.00	\$0.00	\$0.00	\$0.00	\$0.00	
Graduate Metallurgist	\$691,452	\$48,402	4/3 DIDO	D	2	\$96,803	\$0.01	\$0.00	\$0.00	\$0.00	\$0.00	\$0.00	\$0.00	\$0.00	
Metallurgical Accounting Clerk	\$691,452	\$48,402	4/3 DIDO	D	2	\$96,803	\$0.01	\$0.00	\$0.00	\$0.00	\$0.00	\$0.00	\$0.00	\$0.00	
Electrical/Process Control Engineer	\$1,253,128	\$87,719	4/3 DIDO	D	2	\$175,438	\$0.02	\$0.01	\$0.01	\$0.00	\$0.00	\$0.00	\$0.00	\$0.00	
Chief Chemist	\$1,253,128	\$87,719	Full Time	D	1	\$87,719	\$0.01	\$0.00	\$0.00	\$0.00	\$0.00	\$0.00	\$0.00	\$0.00	
Chemist	\$691,452	\$48,402	4/3 DIDO	D	1	\$48,402	\$0.01	\$0.00	\$0.00	\$0.00	\$0.00	\$0.00	\$0.00	\$0.00	
Laboratory Technician	\$480,516	\$33,636	4/3 DIDO	D	2	\$67,272	\$0.01	\$0.00	\$0.00	\$0.00	\$0.00	\$0.00	\$0.00	\$0.00	
<b>Maintenance</b>															
Maintenance Manager	\$1,253,128	\$87,719	Full Time	D	1	\$87,719	\$0.01	\$0.00	\$0.00	\$0.00	\$0.00	\$0.00	\$0.00	\$0.00	
Reliability Engineer	\$976,536	\$68,358	Full Time	D	1	\$68,358	\$0.01	\$0.00	\$0.00	\$0.00	\$0.00	\$0.00	\$0.00	\$0.00	
Mechanical Supervisor	\$691,452	\$48,402	4/3 DIDO	D	2	\$96,803	\$0.01	\$0.00	\$0.00	\$0.00	\$0.00	\$0.00	\$0.00	\$0.00	
Fitter	\$480,516	\$33,636	4/3 DIDO	D	2	\$67,272	\$0.01	\$0.00	\$0.00	\$0.00	\$0.00	\$0.00	\$0.00	\$0.00	
Boilermaker	\$480,516	\$33,636	4/3 DIDO	D	2	\$67,272	\$0.01	\$0.00	\$0.00	\$0.00	\$0.00	\$0.00	\$0.00	\$0.00	
Fitter / Boilermaker Apprentice	\$296,184	\$20,732.88	4/3 DIDO	D	3	\$62,199	\$0.01	\$0.00	\$0.00	\$0.00	\$0.00	\$0.00	\$0.00	\$0.00	
Trades Assisstant / Tool Storeman	\$338,772	\$23,714	4/3 DIDO	D	2	\$47,428	\$0.01	\$0.00	\$0.00	\$0.00	\$0.00	\$0.00	\$0.00	\$0.00	
Electrician	\$542,556	\$37,979	4/3 DIDO	D/N	4	\$151,916	\$0.02	\$0.01	\$0.00	\$0.00	\$0.00	\$0.00	\$0.00	\$0.00	
Instrumentation Technician	\$542,556	\$37,979	4/3 DIDO	D	2	\$75,958	\$0.01	\$0.00	\$0.00	\$0.00	\$0.00	\$0.00	\$0.00	\$0.00	
Electrical Apprentice	\$296,184	\$20,733	4/3 DIDO	D	1	\$20,733	\$0.00	\$0.00	\$0.00	\$0.00	\$0.00	\$0.00	\$0.00	\$0.00	
<b>Administration</b>															
Administration Manager	\$1,123,128	\$78,619	Full Time	D	1	\$78,619	\$0.01	\$0.00	\$0.00	\$0.00	\$0.00	\$0.00	\$0.00	\$0.00	
Senior Accountant	\$1,123,128	\$78,619	Full Time	D	1	\$78,619	\$0.01	\$0.00	\$0.00	\$0.00	\$0.00	\$0.00	\$0.00	\$0.00	
Reception and General Office	\$338,772	\$23,714	Full Time	D	1	\$23,714	\$0.00	\$0.00	\$0.00	\$0.00	\$0.00	\$0.00	\$0.00	\$0.00	
IT Officer	\$1,123,128	\$78,619	Full Time	D	1	\$78,619	\$0.01	\$0.00	\$0.00	\$0.00	\$0.00	\$0.00	\$0.00	\$0.00	
Shipping and Purchasing Officer	\$1,123,128	\$78,619	Full Time	D	1	\$78,619	\$0.01	\$0.00	\$0.00	\$0.00	\$0.00	\$0.00	\$0.00	\$0.00	
HR Superintendent	\$1,123,128	\$78,619	Full Time	D	1	\$78,619	\$0.01	\$0.00	\$0.00	\$0.00	\$0.00	\$0.00	\$0.00	\$0.00	
<b>Environmental and OH&amp;S</b>															
Environment, Health and Safety Manager	\$1,123,128	\$78,619	Full Time	D	1	\$78,619	\$0.01	\$0.00	\$0.00	\$0.00	\$0.00	\$0.00	\$0.00	\$0.00	
Environmental Officer	\$691,452	\$48,402	Full Time	D	1	\$48,402	\$0.01	\$0.00	\$0.00	\$0.00	\$0.00	\$0.00	\$0.00	\$0.00	
Safety and Training Co-ordinator	\$1,123,128	\$78,618.96	Full Time	D	1	\$78,619	\$0.01	\$0.00	\$0.00	\$0.00	\$0.00	\$0.00	\$0.00	\$0.00	
OH&S Technician	\$691,452	\$48,402	Full Time	D	1	\$48,402	\$0.01	\$0.00	\$0.00	\$0.00	\$0.00	\$0.00	\$0.00	\$0.00	
Emergency Response Co-ordinator	\$542,556	\$37,979	Full Time	D	1	\$37,979	\$0.00	\$0.00	\$0.00	\$0.00	\$0.00	\$0.00	\$0.00	\$0.00	
<b>On Costs -General</b>						\$1,152,407	\$0.14	\$0.04	\$0.03	\$0.02	\$0.02	\$0.01	\$0.01	\$0.01	
<b>On Costs - Messing</b>						\$0	\$0.00	\$0.00	\$0.00	\$0.00	\$0.00	\$0.00	\$0.00	\$0.00	
% Split								100%	30%	25%	15%	15%	5%	5%	
<b>Total</b>							<b>98</b>	<b>\$4,930,792</b>	<b>\$0.58</b>	<b>\$0.17</b>	<b>\$0.15</b>	<b>\$0.09</b>	<b>\$0.09</b>	<b>\$0.03</b>	<b>\$0.03</b>



**Document** OPEX-8.5 Mtpa @ 85% Cu Recovery +CuSO4  
**Area** Consumables  
**Client** Deep-South Resources  
**Project** Haib PEA  
**Job #** J5329  
**Doc #** J5329-ES-CA-000-001  
**Rev** A

Concentrator Area/ Equipment Name	Cost (USD) per unit	Unit	Consumption Rate/Unit/Year	Number of Units	Total quantity per Year	Total Cost (USD) per Annum	Estimated Freight Cost	Total Cost (USD) per Annum	USD/t ROM
<b>Crushing</b>									
Gyratory Crusher Liner - Mantle	\$200,000	set	2	1	2	\$400,000	\$36,000	\$436,000	\$0.05
Gyratory Crusher Liner - Concave	\$200,000	set	4	1	4	\$800,000	\$72,000	\$872,000	\$0.10
Cone Crusher Liners - Bowl	\$18,000	set	3	2	6	\$108,000	\$9,720	\$117,720	\$0.01
Cone Crusher Liners - Mantle	\$18,000	set	3	2	6	\$108,000	\$9,720	\$117,720	\$0.01
Secondary Screen	\$20,000	set	4	2	8	\$160,000	\$14,400	\$174,400	\$0.02
HPGR Liner and Plates	\$1,149,512	set	0.3	2	0.5	\$574,756	\$51,728	\$626,484	\$0.07
HPGR Double Deck Screen Liner	\$25,000	set	8	2	16	\$400,000	\$36,000	\$436,000	\$0.05
<b>Sub total - Crushing and Grinding</b>						<b>\$2,550,756</b>	<b>\$229,568</b>	<b>\$2,780,324</b>	<b>\$0.33</b>
<b>Agglomeration and Heap Leaching</b>									
Pad Clearance	\$0.65	m2	150840	1	150840	\$98,046		\$98,046	\$0.01
Pad Earthworks	\$2.50	m3	268610	1	268610	\$671,525		\$671,525	\$0.08
Pad Liner	\$8.40	m2	150840	1	150840	\$1,267,058	\$114,035.18	\$1,381,093	\$0.16
Irrigation Tubing	\$7.00	m	1795	3	5384	\$37,685	\$3,392	\$41,076	\$0.00
<b>Sub total - Agglomeration and Heap Leach</b>						<b>\$2,074,313</b>	<b>\$117,427</b>	<b>\$2,191,740</b>	<b>\$0.26</b>
<b>Electrowinning</b>									
Replacement Cathodes	\$150	set	530	1	530	\$79,500	\$7,155	\$86,655	\$0.01
Replacement Anodes	\$200	set	663	1	663	\$132,500	\$11,925	\$144,425	\$0.02
Copper Sulfate Bags	\$13	each	51081	1	51081	\$638,511	\$57,466	\$695,977	\$0.08
Copper Sulfate Pallets	\$15	each	51081	1	51081	\$766,213	\$68,959	\$835,172	\$0.10
<b>Sub total - Electrowinning</b>						<b>\$1,616,723.52</b>	<b>\$145,505.12</b>	<b>\$1,762,228.63</b>	<b>\$0.21</b>
<b>Services</b>									
Oil	\$900	t	1.08	365	394	\$354,167	\$31,875	\$386,042	\$0.05
Grease	\$450	t	1.08	365	394	\$177,083	\$15,938	\$193,021	\$0.02
Air Filters	\$3,745	set	1	1	1	\$1,873	\$169	\$2,041	\$0.00
<b>Sub total - Services</b>						<b>\$533,123</b>	<b>\$47,981</b>	<b>\$581,104</b>	<b>\$0.07</b>
<b>Misc</b>									
Mobile Lighting Tower Parts	\$700	set	1	3	3	\$2,100	\$189	\$2,289	\$0.00
Light Vehicle Parts	\$350	set	1	6	6	\$2,100	\$189	\$2,289	\$0.00
Water Truck Parts	\$2,100	set	1	1	1	\$2,100	\$189	\$2,289	\$0.00
Forklift Parts	\$1,750	set	1	2	2	\$3,500	\$315	\$3,815	\$0.00
Ambulance Parts/Consumables	\$700	set	1	1	1	\$700	\$63	\$763	\$0.00
<b>Sub total - Misc</b>						<b>\$10,500</b>	<b>\$945</b>	<b>\$11,445</b>	<b>\$0.00</b>
<b>Total</b>						<b>\$6,785,415</b>	<b>\$541,426</b>	<b>\$7,326,841</b>	<b>\$0.86</b>



Document  
Area  
Client  
Project  
Job #  
Doc #  
Rev

OPEX-8.5 Mtpa @ 85% Cu Recovery +CuSO4  
Reagents  
Deep-South Resources  
Haib PEA  
J5329  
J5329-ES-CA-000-001  
A

Reagents	USD per unit CIF Luderitz	Unit	Consumed per Year	Reagent Cost (USD) per Annum	Transport Cost (USD) Port to Haib	Total Cost (USD) per Annum	USD/t ROM
Sulphuric Acid	\$275	t	26,725	7,349,248		\$7,349,248	\$0.86
Polyacrylamide	\$2,150	t	1,241	2,667,688		\$2,667,688	\$0.31
LIX984N	\$12,000	t	233	2,797,055	10,489	\$2,807,544	\$0.33
Quicklime	\$300	t	6,127	1,838,244	275,737	\$2,113,980	\$0.25
Limestone	\$150	t	28,614	4,292,066	1,287,620	\$5,579,686	\$0.66
Calcrete/Dolomite	\$12.50	t	0	0		\$0	\$0.00
Kerosene	\$550	t	1,321	726,457	59,437	\$785,895	\$0.09
Raw Water	\$0.92	kL	1,114,137	1,020,883		\$1,020,883	\$0.12
Flocculant	\$2,150	t	54	115,771		\$115,771	\$0.01
Diesel	\$0.94	L	3,923,449	3,680,195	210,185	\$3,890,380	\$0.46
<b>Total</b>						<b>\$26,331,076</b>	<b>\$3.10</b>

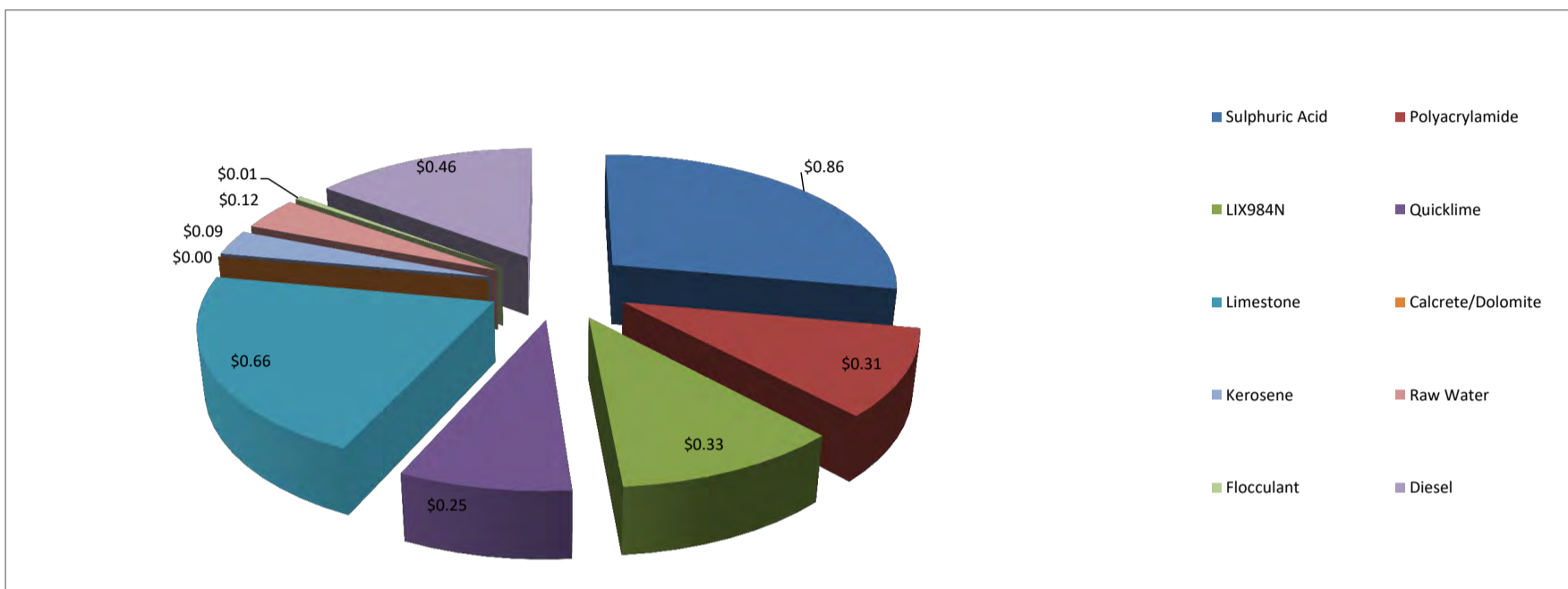



**Document** OPEX-8.5 Mtpa @ 85% Cu Recovery +CuSO4  
**Area** Power  
**Client** Deep-South Resources  
**Project** Haib PEA  
**Job #** J5329  
**Doc #** J5329-ES-CA-000-001  
**Rev** A

Concentrator Area/ Equipment Name	Installed Power (kW)	Utilisation %	Power Draw (kW)	Operating Hours	Consumption (kWhpa)	Total Cost (USD) per Annum	USD/t ROM
Crushing	3,666	70	2566	6,132	15,736,517	\$1,327,596	\$0.16
HPGR	4,661	90	4195	7,884	33,073,727	\$2,790,232	\$0.33
Agglomeration and Heap Leaching	2,057	98	2016	8,585	17,306,192	\$1,460,020	\$0.17
Copper SX, EW and Crystallisation	4,420	90	3978	7,884	31,361,975	\$2,645,822	\$0.31
Iron Removal and Tailings	202	90	182	7,884	1,434,560	\$121,025	\$0.01
Process and Raw Water	335	90	302	7,884	2,378,374	\$200,649	\$0.02
Reagents	30	90	27	7,884	215,561	\$18,186	\$0.00
Services	28	70	20	7,884	157,007	\$13,246	\$0.00
<b>Total</b>	<b>15,400</b>		<b>13,286</b>		<b>101,663,914</b>	<b>\$8,576,774</b>	<b>\$1.01</b>



**Document** OPEX-8.5 Mtpa @ 85% Cu Recovery +CuSO4  
**Area** Maintenance  
**Client** Deep-South Resources  
**Project** Haib PEA  
**Job #** J5329  
**Doc #** J5329-ES-CA-000-001  
**Rev** A

Area	Mechanical CAPEX (USD)	Maintenance Cost (%)	Maintenance Cost per year (USD)	USD/t ROM
Crushing	\$16,910,000	5%	\$845,500	\$0.10
HPGR	\$12,991,000	5%	\$649,550	\$0.08
Agglomeration and Heap Leaching	\$13,316,000	1%	\$133,160	\$0.02
Copper SX, EW and Crystallisation	\$24,187,000	3%	\$725,610	\$0.09
Iron Removal and Tailings	\$2,812,000	3%	\$84,360	\$0.01
Process and Raw Water	\$1,518,000	1%	\$15,180	\$0.00
Reagents	\$2,590,200	3%	\$77,706	\$0.01
Services	\$1,633,000	3%	\$48,990	\$0.01
<b>Total</b>	<b>\$75,957,200</b>		<b>\$2,580,056</b>	<b>\$0.30</b>





## DOCUMENT COVER SHEET

CLIENT:

PROJECT TITLE:

PROJECT NO.:

DOCUMENT TITLE:

DOCUMENT NO:

Option Description:

THIS DOCUMENT HAS BEEN PREPARED AND CHECKED IN ACCORDANCE WITH THE FOLLOWING WORK INSTRUCTIONS / CHECKLISTS TO THE NOMINATED CHECKING METHOD & LEVEL.		
CHECKING METHOD	CHECKING LEVEL	
WORK INSTRUCTION / CHECKLIST NO.	OR	CH
NAME		DATE
OR		
CH		

A	21/04/20	Issue as draft to client	DC		
A	8/04/20	Began populating updated layout	BM	LZ	
<b>Rev</b>	<b>Date</b>	<b>Revision</b>	<b>By</b>	<b>Ch'k</b>	<b>L.E.</b>



Title: OPEX-20 Mpa @ 80% Cu Recovery + CuSO4  
 Document No.: J529-ES-CA-000-001  
 Project: Halib PEA  
 Client: Deep-South Resources  
 Date: 08-Apr-20  
 Rev: A  
 Option: Whole Ore Heap Leach  
 Accuracy: ± 30%  
 Comments:

Key Inputs and Outputs			
Plant Throughput dry	20,000,000	tpa	
Utilisation (Crushing)	6,132	h/a	
Utilisation (Grinding)	7,884	h/a	
Plant Throughput dry	2,537	dph	
Head Grade	0.310%	% Cu	
Recovery	80	% Cu	
Annual Production	35,332	t Cu	
	77,894,214	lb Cu	
	51,981	t CuSO4.5H2O	
	112,613,875	lb CuSO4.5H2O	
	113,720,448	Total lb Cu Eq	
Power Cost	\$0.84	USD/kWh	
Total Power	11.05	MWh	
Abrasion Index	0.49		
Fixed Component	\$11,237,479	USD/a	
Fixed Component	\$0.56	USD/t ROM	
Variable Component	\$79,561,810	USD/a	
Variable Component	\$3.98	USD/t ROM	
<b>Operating Cost Estimation</b>	<b>\$4.54</b>	<b>USD/t ROM</b>	
<b>Operating Cost Estimation</b>	<b>\$0.80</b>	<b>USD/lb Cu Eq</b>	

Miscellaneous Costs Only		
Cost	USD/a	USD/t ROM
Laboratory Costs	\$1,000,000	\$0.05
Contractors	\$100,000	\$0.01
Vehicle Fleet	\$100,000	\$0.01
<b>Total</b>	<b>\$1,200,000</b>	<b>\$0.06</b>

Summary 1 - Cost per pound of copper produced (Based on Commodity)					
	Cost		Fixed %	Fixed Cost USD/a	Variable USD/a
	USD/a	USD/lb Cu Eq			
Power	\$18,636,581	\$0.16	15.0	\$2,795,487	\$15,841,094
Consumables	\$13,194,092	\$0.12	5.0	\$659,705	\$12,534,388
Reagents	\$47,202,042	\$0.42	0.0	\$0	\$47,202,042
Labour	\$5,879,177	\$0.05	100.0	\$5,879,177	\$0
Maintenance	\$4,687,396	\$0.04	15.0	\$703,109	\$3,984,287
Misc	\$1,200,000	\$0.01	100.0	\$1,200,000	\$0
<b>Total</b>	<b>\$90,799,289</b>	<b>\$0.80</b>	<b>12.4</b>	<b>\$11,237,479</b>	<b>\$79,561,810</b>

Summary 1 - Cost per tonne of Concentrate (Based on Commodity)					
	Cost		Fixed Cost USD/a	Variable USD/a	Overall Distribution %
	USD/a	USD/t ROM			
Power	\$18,636,581	\$0.93	\$15,841,094	20.5	
Consumables	\$13,194,092	\$0.66	\$659,705	14.5	
Reagents	\$47,202,042	\$2.36	\$0	52.0	
Labour	\$5,879,177	\$0.29	\$5,879,177	6.5	
Maintenance	\$4,687,396	\$0.23	\$703,109	5.2	
Miscellaneous	\$1,200,000	\$0.06	\$1,200,000	0.7	
<b>Total</b>	<b>\$90,799,289</b>	<b>\$4.54</b>	<b>\$11,237,479</b>	<b>\$79,561,810</b>	<b>100.0</b>

Reagents					
	Price USD/unit	Unit	Consumption (units/a)	Cost	
				USD/a	USD/t ROM
Sulphuric Acid	\$275	t	37607	\$12,034,277	0.60
Polyacrylamide	\$2,150	t	2926	\$6,422,349	0.32
LSOAN	\$12,000	t	540	\$6,505,996	0.33
Quicklime	\$300	t	13887	\$4,171,125	0.24
Limestone	\$150	t	46555	\$9,078,250	0.45
Calcrete/Dolomite	\$13	t	0	\$0	0.00
Kerosene	\$550	t	3106	\$1,849,164	0.09
Raw Water	\$1	kL	2476430	\$2,298,237	0.11
Flocculant	\$2,150	t	119	\$262,275	0.01
Diesel	\$1	L	3923449	\$3,890,380	0.19
<b>Total</b>				<b>\$47,202,042</b>	<b>\$2.36</b>

Maintenance				
	Mechanical Capital USD	Maintenance %	Cost	
			USD/a	USD/t ROM
Crushing	\$33,812,000	5%	\$1,690,600	\$0.08
HPGR	\$24,532,000	5%	\$1,226,600	\$0.06
Agglomeration and Heap Leaching	\$24,974,000	1%	\$249,740	\$0.01
Copper SX and EW	\$4,819,000	3%	\$1,254,570	\$0.06
Iron Removal and Tailings	\$3,583,000	3%	\$107,490	\$0.01
Process and Raw Water	\$2,357,000	1%	\$23,570	\$0.00
Reagents	\$2,891,200	3%	\$85,836	\$0.00
Services	\$1,633,000	3%	\$48,990	\$0.00
<b>Total</b>	<b>\$135,671,200</b>	<b>3.46%</b>	<b>\$4,687,396</b>	<b>\$0.23</b>

Plant Standby Cost				
	Assumptions and Bases	% of annual total cost	Standby Cost USD/a	Dist %
Consumables	Air and water service costs persist	5.0	\$659,705	5.9
Reagents	No reagent consumption due to no throughput	0.0	\$0	0.0
Labour	All staff retain their positions	100.0	\$5,879,177	52.3
Maintenance	Operational equipment maintenance	15.0	\$703,109	6.3
Miscellaneous	Contract agreements	100.0	\$1,200,000	10.7
<b>Total</b>		<b>12.4</b>	<b>\$11,237,479</b>	<b>100.0</b>

Power						
	Installed kW	Utilisation %	kW Draw	Total kWh/a	Cost	
					USD/a	USD/t ROM
Crushing	7,072	70	4,950	30,355,149	\$2,560,882	\$0.13
HPGR	8,607	90	7,746	61,071,929	\$5,152,272	\$0.26
Agglomeration and Heap Leaching	3,803	98	3,727	31,998,686	\$2,699,537	\$0.13
Copper SX and EW	12,917	90	11,625	91,653,407	\$7,732,248	\$0.39
Iron Removal and Tailings	309	90	279	2,192,125	\$184,936	\$0.01
Process and Raw Water	452	90	407	3,209,730	\$270,796	\$0.01
Reagents	38	90	34	268,764	\$22,674	\$0.00
Services	28	70	20	157,007	\$13,246	\$0.00
<b>Total</b>	<b>33,227</b>		<b>28,788</b>	<b>220,906,798</b>	<b>\$18,636,581</b>	<b>\$0.93</b>

Consumables						
	Unit	Price USD/unit	Consumption (units/a)	Cost		
				USD/a	Freight USD/t ROM	
Gyratory Crusher Liner - Mantle	set	\$200,000.00	4	\$800,000	\$72,000	\$0.04
Gyratory Crusher Liner - Concave	set	\$200,000.00	8	\$1,600,000	\$144,000	\$0.09
Cone Crusher Liners - Bowl	set	\$18,000.00	12	\$216,000	\$19,440	\$0.01
Cone Crusher Liners - Mantle	set	\$18,000.00	12	\$216,000	\$19,440	\$0.01
Secondary Screen	set	\$200,000.00	8	\$1,600,000	\$144,000	\$0.01
HPGR Liner and Plates	set	\$1,148,512.00	1	\$574,256	\$51,728	\$0.03
HPGR Double Deck Screen Liner	set	\$25,000.00	16	\$400,000	\$36,000	\$0.02
Pad Clearance	m2	\$0.65	354918	\$230,697	\$0.01	\$0.01
Pad Earthworks	m3	\$2.50	632023	\$1,580,058	\$0.08	\$0.08
Pad Liner	m2	\$8.40	354918	\$2,981,312	\$268,318	\$0.16
Irrigation Tubing	m	\$7.00	5384	\$37,688	\$3,362	\$0.00
Replacement Cathodes	set	\$159.00	2259	\$338,820	\$30,494	\$0.02
Replacement Anodes	set	\$200.00	2259	\$451,760	\$40,658	\$0.02
Copper Sulfate Bags	each	\$12.50	51081	\$638,511	\$57,466	\$0.03
Copper Sulfate Pallets	each	\$15.00	51081	\$766,213	\$68,959	\$0.04
Oil	t	\$90.00	926	\$83,333	\$75,000	\$0.05
Grease	t	\$450.00	926	\$416,667	\$37,500	\$0.02
Air Filters	set	\$3,745.28	1	\$1,873	\$169	\$0.00
Mobile Lighting Tower Parts	set	\$700.00	3	\$2,100	\$189	\$0.00
Light Vehicle Parts	set	\$350.00	6	\$2,100	\$189	\$0.00
Water Truck Parts	set	\$2,100.00	1	\$2,100	\$189	\$0.00
Forklift Parts	set	\$1,750.00	2	\$3,500	\$315	\$0.00
Ambulance Parts/Consumables	set	\$700.00	1	\$700	\$63	\$0.00
<b>Total</b>				<b>\$13,194,092</b>	<b>\$0.66</b>	

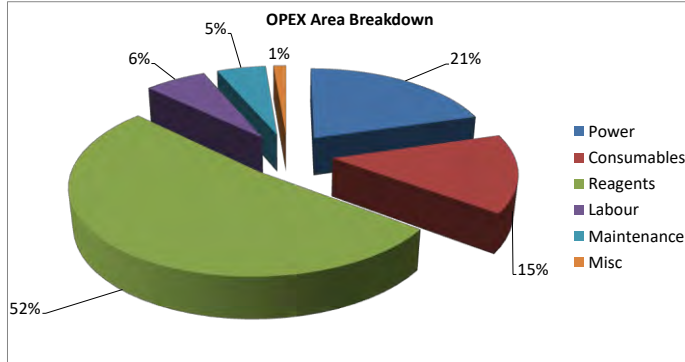

Rev	Date	Engineer	Comments
A	21/04/20	DC	Issue as draft to client
A	8/04/20	BM	Began populating updated layout

Key Input	Only Adjust variables in Blue	Source of information
Throughput (tph)	2537	Calculation
Throughput (tpe)	20,000,000	Basis value
Availability (Crushing)	70%	METS assumed value
Availability (Grinding)	90%	METS assumed value
Operating Hour pa (Crushing)	6132	Calculation
Operating Hour pa (Grinding)	7884	Calculation
Exchange rate (1 NAD = 0.07 USD)	\$0.07	<a href="http://www.xe.com">www.xe.com</a>

Price List	Units	Price USD/unit	Source of information
Gyratory Crusher Liner - Mantle	set	\$150,000	
Gyratory Crusher Liner - Concave	set	\$150,000	
Cone Crusher Liners - Bowl	set	\$18,000	
Cone Crusher Liners - Mantle	set	\$18,000	
Secondary Screen	set	\$20,000	
HPGR Liner and Plates	set	\$1,149,512	Koppers
HPGR Double Deck Screen Liner	set	\$25,000	
Pad Liner	m <sup>2</sup>	\$8.4	
Irrigation Tubing	m	\$7	
Oil	t	\$900	
Grease	t	\$450	
Air Filters	set	\$3,745	
Mobile Lighting Tower Parts	set	\$700	
Light Vehicle Parts	set	\$350	
Water Truck Parts	set	\$2,100	
Forklift Parts	set	\$1,750	
Ambulance Parts/Consumables	set	\$700	
Sulphuric Acid	t	\$275.00	DAP Noordoewer
Polyacrylamide	t	\$2,150.00	DAP Noordoewer
LIX984N	t	\$12,000	
Quicklime	t	\$300	
Limestone	t	\$150	
Calcrete/Dolomite	t	\$12.50	Assumption, mining cost+crushing cost
Kerosene	t	\$550	
Raw Water	kL	\$0.92	Calculation
Flocculant	t	\$2,150	DAP Noordoewer
Diesel	L	\$0.94	globalpetrolprices.com
Cathode	set	\$150.00	
Anode	set	\$200.00	
Power Cost (NS)	kWh	\$1.21	
Power Cost (US\$)	kWh	\$0.084	Calculation

\*Manipulation of the mass balance worksheet will automatically update the OPEX model



Document OPEX-20 Mtpa @ 80% Cu Recovery +CuSO4  
 Area Labour  
 Client Deep-South Resources  
 Project Haib PEA  
 Job # J5329  
 Doc # J5329-ES-CA-000-001  
 Rev A

Personnel	Annual Salary (N\$)	Annual Salary (USD)	Roster	Shift (D or D/N)	#	Total Cost (USD) per Annum	USD/t ROM	Crushing	Agglomeration and Heap Leaching	Copper SX and EW	Iron Removal and Tailings	Process and Raw Water	Reagents	Services	
<b>Process Plant</b>															
General Manager	\$2,255,964	\$157,917	Full Time	D	1	\$157,917	\$0.01	\$0.00	\$0.00	\$0.00	\$0.00	\$0.00	\$0.00	\$0.00	
Personal Assistant	\$296,184	\$20,733	Full Time	D	1	\$20,733	\$0.00	\$0.00	\$0.00	\$0.00	\$0.00	\$0.00	\$0.00	\$0.00	
<b>Processing</b>															
Process Manager	\$1,253,128	\$87,719	Full Time	D	1	\$87,719	\$0.00	\$0.00	\$0.00	\$0.00	\$0.00	\$0.00	\$0.00	\$0.00	
Plant Superintendent/Supervisor	\$1,123,128	\$78,619	Full Time	D	1	\$78,619	\$0.00	\$0.00	\$0.00	\$0.00	\$0.00	\$0.00	\$0.00	\$0.00	
Shift Supervisor	\$1,123,128	\$78,619	Full Time	D	1	\$78,619	\$0.00	\$0.00	\$0.00	\$0.00	\$0.00	\$0.00	\$0.00	\$0.00	
Plant Operator	\$296,184	\$20,733	4/3 DIDO	D/N	68	\$1,409,836	\$0.07	\$0.02	\$0.02	\$0.01	\$0.01	\$0.00	\$0.00	\$0.00	
Day Crew / Cleanup	\$296,184	\$20,733	4/3 DIDO	D	4	\$82,932	\$0.00	\$0.00	\$0.00	\$0.00	\$0.00	\$0.00	\$0.00	\$0.00	
Senior Metallurgist	\$1,253,128	\$87,719	4/3 DIDO	D	2	\$175,438	\$0.01	\$0.00	\$0.00	\$0.00	\$0.00	\$0.00	\$0.00	\$0.00	
Metallurgist / Process Engineer	\$1,123,128	\$78,619	4/3 DIDO	D	2	\$157,238	\$0.01	\$0.00	\$0.00	\$0.00	\$0.00	\$0.00	\$0.00	\$0.00	
Graduate Metallurgist	\$691,452	\$48,402	4/3 DIDO	D	2	\$96,803	\$0.00	\$0.00	\$0.00	\$0.00	\$0.00	\$0.00	\$0.00	\$0.00	
Metallurgical Accounting Clerk	\$691,452	\$48,402	4/3 DIDO	D	2	\$96,803	\$0.00	\$0.00	\$0.00	\$0.00	\$0.00	\$0.00	\$0.00	\$0.00	
Electrical/Process Control Engineer	\$1,253,128	\$87,719	4/3 DIDO	D	2	\$175,438	\$0.01	\$0.00	\$0.00	\$0.00	\$0.00	\$0.00	\$0.00	\$0.00	
Chief Chemist	\$1,253,128	\$87,719	Full Time	D	1	\$87,719	\$0.00	\$0.00	\$0.00	\$0.00	\$0.00	\$0.00	\$0.00	\$0.00	
Chemist	\$691,452	\$48,402	4/3 DIDO	D	1	\$48,402	\$0.00	\$0.00	\$0.00	\$0.00	\$0.00	\$0.00	\$0.00	\$0.00	
Laboratory Technician	\$480,516	\$33,636	4/3 DIDO	D	2	\$67,272	\$0.00	\$0.00	\$0.00	\$0.00	\$0.00	\$0.00	\$0.00	\$0.00	
<b>Maintenance</b>															
Maintenance Manager	\$1,253,128	\$87,719	Full Time	D	1	\$87,719	\$0.00	\$0.00	\$0.00	\$0.00	\$0.00	\$0.00	\$0.00	\$0.00	
Reliability Engineer	\$976,536	\$68,358	Full Time	D	1	\$68,358	\$0.00	\$0.00	\$0.00	\$0.00	\$0.00	\$0.00	\$0.00	\$0.00	
Mechanical Supervisor	\$691,452	\$48,402	4/3 DIDO	D	2	\$96,803	\$0.00	\$0.00	\$0.00	\$0.00	\$0.00	\$0.00	\$0.00	\$0.00	
Fitter	\$480,516	\$33,636	4/3 DIDO	D	3	\$100,908	\$0.01	\$0.00	\$0.00	\$0.00	\$0.00	\$0.00	\$0.00	\$0.00	
Boilermaker	\$480,516	\$33,636	4/3 DIDO	D	3	\$100,908	\$0.01	\$0.00	\$0.00	\$0.00	\$0.00	\$0.00	\$0.00	\$0.00	
Fitter / Boilermaker Apprentice	\$296,184	\$20,732.88	4/3 DIDO	D	5	\$103,664	\$0.01	\$0.00	\$0.00	\$0.00	\$0.00	\$0.00	\$0.00	\$0.00	
Trades Assisntant / Tool Storeman	\$338,772	\$23,714	4/3 DIDO	D	3	\$71,142	\$0.00	\$0.00	\$0.00	\$0.00	\$0.00	\$0.00	\$0.00	\$0.00	
Electrician	\$542,556	\$37,979	4/3 DIDO	D/N	6	\$227,874	\$0.01	\$0.00	\$0.00	\$0.00	\$0.00	\$0.00	\$0.00	\$0.00	
Instrumentation Technician	\$542,556	\$37,979	4/3 DIDO	D	2	\$75,958	\$0.00	\$0.00	\$0.00	\$0.00	\$0.00	\$0.00	\$0.00	\$0.00	
Electrical Apprentice	\$296,184	\$20,733	4/3 DIDO	D	2	\$41,466	\$0.00	\$0.00	\$0.00	\$0.00	\$0.00	\$0.00	\$0.00	\$0.00	
<b>Administration</b>															
Administration Manager	\$1,123,128	\$78,619	Full Time	D	1	\$78,619	\$0.00	\$0.00	\$0.00	\$0.00	\$0.00	\$0.00	\$0.00	\$0.00	
Senior Accountant	\$1,123,128	\$78,619	Full Time	D	1	\$78,619	\$0.00	\$0.00	\$0.00	\$0.00	\$0.00	\$0.00	\$0.00	\$0.00	
Reception and General Office	\$338,772	\$23,714	Full Time	D	1	\$23,714	\$0.00	\$0.00	\$0.00	\$0.00	\$0.00	\$0.00	\$0.00	\$0.00	
IT Officer	\$1,123,128	\$78,619	Full Time	D	1	\$78,619	\$0.00	\$0.00	\$0.00	\$0.00	\$0.00	\$0.00	\$0.00	\$0.00	
Shipping and Purchasing Officer	\$1,123,128	\$78,619	Full Time	D	1	\$78,619	\$0.00	\$0.00	\$0.00	\$0.00	\$0.00	\$0.00	\$0.00	\$0.00	
HR Superintendent	\$1,123,128	\$78,619	Full Time	D	1	\$78,619	\$0.00	\$0.00	\$0.00	\$0.00	\$0.00	\$0.00	\$0.00	\$0.00	
<b>Environmental and OH&amp;S</b>															
Environment, Health and Safety Manager	\$1,123,128	\$78,619	Full Time	D	1	\$78,619	\$0.00	\$0.00	\$0.00	\$0.00	\$0.00	\$0.00	\$0.00	\$0.00	
Environmental Officer	\$691,452	\$48,402	Full Time	D	1	\$48,402	\$0.00	\$0.00	\$0.00	\$0.00	\$0.00	\$0.00	\$0.00	\$0.00	
Safety and Training Co-ordinator	\$1,123,128	\$78,618.96	Full Time	D	1	\$78,619	\$0.00	\$0.00	\$0.00	\$0.00	\$0.00	\$0.00	\$0.00	\$0.00	
OH&S Technician	\$691,452	\$48,402	Full Time	D	1	\$48,402	\$0.00	\$0.00	\$0.00	\$0.00	\$0.00	\$0.00	\$0.00	\$0.00	
Emergency Response Co-ordinator	\$542,556	\$37,979	Full Time	D	1	\$37,979	\$0.00	\$0.00	\$0.00	\$0.00	\$0.00	\$0.00	\$0.00	\$0.00	
<b>On Costs -General</b>						\$1,374,061	\$0.07	\$0.02	\$0.02	\$0.01	\$0.01	\$0.00	\$0.00	\$0.00	
<b>On Costs - Messing</b>						\$0	\$0.00	\$0.00	\$0.00	\$0.00	\$0.00	\$0.00	\$0.00	\$0.00	
% Split							100%	30%	25%	15%	15%	5%	5%	5%	
<b>Total</b>						<b>130</b>	<b>\$5,879,177</b>	<b>\$0.29</b>	<b>\$0.09</b>	<b>\$0.07</b>	<b>\$0.04</b>	<b>\$0.04</b>	<b>\$0.01</b>	<b>\$0.01</b>	<b>\$0.01</b>



**Document** OPEX-20 Mtpa @ 80% Cu Recovery +CuSO4  
**Area** Consumables  
**Client** Deep-South Resources  
**Project** Hab PEA  
**Job #** J5329  
**Doc #** J5329-ES-CA-000-001  
**Rev** A

Concentrator Area/ Equipment Name	Cost (USD) per unit	Unit	Consumption Rate/Unit/Year	Number of Units	Total quantity per Year	Total Cost (USD) per Annum	Estimated Freight Cost	Total Cost (USD) per Annum	USD/t ROM
<b>Crushing</b>									
Gyratory Crusher Liner - Mantle	\$200,000	set	2	1	4	\$800,000	\$72,000	\$872,000	\$0.04
Gyratory Crusher Liner - Concave	\$200,000	set	4	1	8	\$1,600,000	\$144,000	\$1,744,000	\$0.09
Cone Crusher Liners - Bowl	\$18,000	set	3	2	12	\$216,000	\$19,440	\$235,440	\$0.01
Cone Crusher Liners - Mantle	\$18,000	set	3	2	12	\$216,000	\$19,440	\$235,440	\$0.01
Secondary Screen	\$20,000	set	4	2	8	\$160,000	\$14,400	\$174,400	\$0.01
HPGR Liner and Plates	\$1,149,512	set	0.3	2	0.5	\$574,756	\$51,728	\$626,484	\$0.03
HPGR Double Deck Screen Liner	\$25,000	set	8	2	16	\$400,000	\$36,000	\$436,000	\$0.02
<b>Sub total - Crushing and Grinding</b>						<b>\$3,966,756</b>	<b>\$357,008</b>	<b>\$4,323,764</b>	<b>\$0.22</b>
<b>Agglomeration and Heap Leaching</b>									
Pad Clearance	\$0.65	m2	354918	1	354918	\$230,697		\$230,697	\$0.01
Pad Earthworks	\$2.50	m3	632023	1	632023	\$1,580,058		\$1,580,058	\$0.08
Pad Liner	\$8.40	m2	354918	1	354918	\$2,981,312	\$268,318.08	\$3,249,630	\$0.16
Irrigation Tubing	\$7.00	m	1795	3	5384	\$37,685	\$3,392	\$41,076	\$0.00
<b>Sub total - Agglomeration and Heap Leach</b>						<b>\$4,829,752</b>	<b>\$271,710</b>	<b>\$5,101,461</b>	<b>\$0.26</b>
<b>Electrowinning</b>									
Replacement Cathodes	\$150	set	2259	1	2259	\$338,820	\$30,494	\$369,314	\$0.02
Replacement Anodes	\$200	set	2259	1	2259	\$451,760	\$40,658	\$492,418	\$0.02
Copper Sulfate Bags	\$13	each	51081	1	51081	\$638,511	\$57,466	\$695,977	\$0.03
Copper Sulfate Pallets	\$15	each	51081	1	51081	\$766,213	\$68,959	\$835,172	\$0.04
<b>Sub total - Electrowinning</b>						<b>\$790,580</b>	<b>\$71,152</b>	<b>\$2,392,881</b>	<b>\$0.04</b>
<b>Services</b>									
Oil	\$900	t	2.54	365	926	\$833,333	\$75,000	\$908,333	\$0.05
Grease	\$450	t	2.54	365	926	\$416,667	\$37,500	\$454,167	\$0.02
Air Filters	\$3,745	set	1	1	1	\$1,873	\$169	\$2,041	\$0.00
<b>Sub total - Services</b>						<b>\$1,251,873</b>	<b>\$112,669</b>	<b>\$1,364,541</b>	<b>\$0.07</b>
<b>Misc</b>									
Mobile Lighting Tower Parts	\$700	set	1	3	3	\$2,100	\$189	\$2,289	\$0.00
Light Vehicle Parts	\$350	set	1	6	6	\$2,100	\$189	\$2,289	\$0.00
Water Truck Parts	\$2,100	set	1	1	1	\$2,100	\$189	\$2,289	\$0.00
Forklift Parts	\$1,750	set	1	2	2	\$3,500	\$315	\$3,815	\$0.00
Ambulance Parts/Consumables	\$700	set	1	1	1	\$700	\$63	\$763	\$0.00
<b>Sub total - Misc</b>						<b>\$10,500</b>	<b>\$945</b>	<b>\$11,445</b>	<b>\$0.00</b>
<b>Total</b>						<b>\$10,849,460</b>	<b>\$813,483</b>	<b>\$13,194,092</b>	<b>\$0.58</b>



Document  
Area  
Client  
Project  
Job #  
Doc #  
Rev

OPEX-20 Mtpa @ 80% Cu Recovery +CuSO4  
Reagents  
Deep-South Resources  
Haib PEA  
J5329  
J5329-ES-CA-000-001  
A

Reagents	USD per unit CIF Luderitz	Unit	Consumed per Year	Reagent Cost (USD) per Annum	Transport Cost (USD) Port to Haib	Total Cost (USD) per Annum	USD/t ROM
Sulphuric Acid	\$275	t	37,607	10,341,957	1,692,320	\$12,034,277	\$0.60
Polyacrylamide	\$2,150	t	2,926	6,290,684	131,665	\$6,422,349	\$0.32
LIX984N	\$12,000	t	548	6,581,306	24,680	\$6,605,986	\$0.33
Quicklime	\$300	t	13,887	4,166,195	624,929	\$4,791,125	\$0.24
Limestone	\$150	t	46,555	6,983,269	2,094,981	\$9,078,250	\$0.45
Calcrete/Dolomite	\$12.50	t	0	0	0	\$0	\$0.00
Kerosene	\$550	t	3,108	1,709,311	139,853	\$1,849,164	\$0.09
Raw Water	\$0.92	kL	2,475,430	2,268,237	0	\$2,268,237	\$0.11
Flocculant	\$2,150	t	119	256,898	5,377	\$262,275	\$0.01
Diesel	\$0.94	L	3,923,449	3,680,195	210,185	\$3,890,380	\$0.19
<b>Total</b>						<b>\$47,202,042</b>	<b>\$2.36</b>

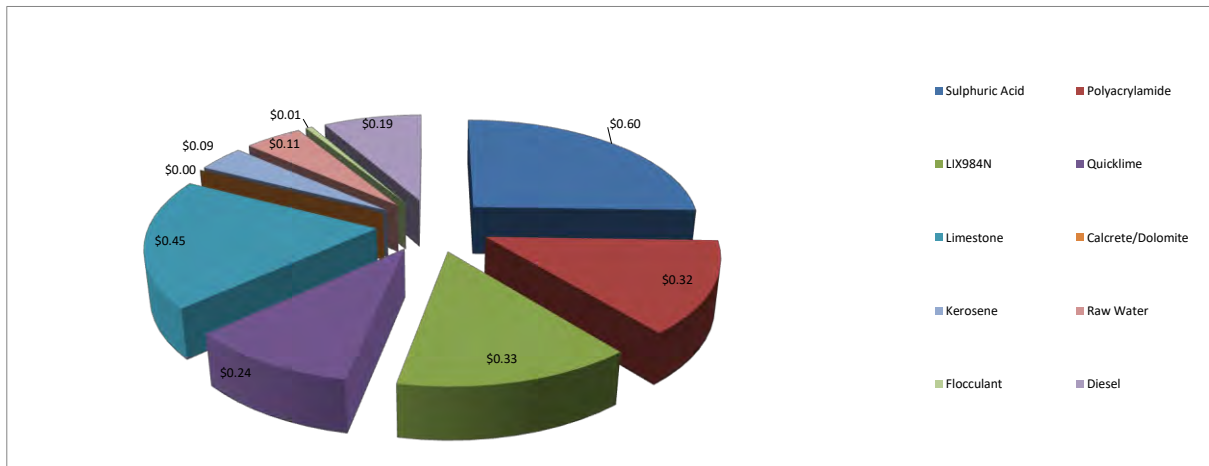



**Document** OPEX-20 Mtpa @ 80% Cu Recovery +CuSO4  
**Area** Power  
**Client** Deep-South Resources  
**Project** Haib PEA  
**Job #** J5329  
**Doc #** J5329-ES-CA-000-001  
**Rev** A

Concentrator Area/ Equipment Name	Installed Power (kW)	Utilisation %	Power Draw (kW)	Operating Hours	Consumption (kWhpa)	Total Cost (USD) per Annum	USD/t ROM
Crushing	7,072	70	4950	6,132	30,355,149	\$2,560,882	\$0.13
HPGR	8,607	90	7746	7,884	61,071,929	\$5,152,272	\$0.26
Agglomeration and Heap Leaching	3,803	98	3727	8,585	31,998,686	\$2,699,537	\$0.13
Copper SX and EW	12,917	90	11625	7,884	91,653,407	\$7,732,248	\$0.39
Iron Removal and Tailings	309	90	278	7,884	2,192,125	\$184,936	\$0.01
Process and Raw Water	452	90	407	7,884	3,209,730	\$270,786	\$0.01
Reagents	38	90	34	7,884	268,764	\$22,674	\$0.00
Services	28	70	20	7,884	157,007	\$13,246	\$0.00
<b>Total</b>	<b>33,227</b>		<b>28,788</b>		<b>220,906,798</b>	<b>\$18,636,581</b>	<b>\$0.93</b>





**Document** OPEX-20 Mtpa @ 80% Cu Recovery +CuSO4  
**Area** Maintenance  
**Client** Deep-South Resources  
**Project** Haib PEA  
**Job #** J5329  
**Doc #** J5329-ES-CA-000-001  
**Rev** A

Area	Mechanical CAPEX (USD)	Maintenance Cost (%)	Maintenance Cost per year (USD)	USD/t ROM
Crushing	\$33,812,000	5%	\$1,690,600	\$0.08
HPGR	\$24,532,000	5%	\$1,226,600	\$0.06
Agglomeration and Heap Leaching	\$24,974,000	1%	\$249,740	\$0.01
Copper SX and EW	\$41,819,000	3%	\$1,254,570	\$0.06
Iron Removal and Tailings	\$3,583,000	3%	\$107,490	\$0.01
Process and Raw Water	\$2,357,000	1%	\$23,570	\$0.00
Reagents	\$2,861,200	3%	\$85,836	\$0.00
Services	\$1,633,000	3%	\$48,990	\$0.00
<b>Total</b>	<b>\$135,571,200</b>		<b>\$4,687,396</b>	<b>\$0.23</b>



## DOCUMENT COVER SHEET

**CLIENT:** Deep-South Resources

**PROJECT TITLE:** Haib PEA

**PROJECT NO.:** J5329

**DOCUMENT TITLE:** OPEX-20 Mtpa @ 85% Cu Recovery

**DOCUMENT NO:** J5329-ES-CA-000-001

**Option Description:** Whole Ore Heap Leach

THIS DOCUMENT HAS BEEN PREPARED AND CHECKED IN ACCORDANCE WITH THE FOLLOWING WORK INSTRUCTIONS / CHECKLISTS TO THE NOMINATED CHECKING METHOD & LEVEL.			
CHECKING METHOD		CHECKING LEVEL	
WORK INSTRUCTION / CHECKLIST NO.	OR	CH	
NAME	DATE		
OR			
CH			

0	13/03/20	Issue as draft to client	DC		
A	10/01/20	Began populating updated layout	LZ	BM	
Rev	Date	Revision	By	Ch'k	L.E.



Title: OPEX-20 Mtpa @ 85% Cu Recovery  
 Document No.: J5329-ES-CA-000-001  
 Project: Halb PEA  
 Client: Deep-South Resources  
 Date: 10-Jan-20  
 Rev: A  
 Option: Whole Ore Heap Leach  
 Accuracy: ± 30%  
 Comments:

Summary 1 - Cost per pound of copper produced (Based on Commodity)					
	Cost		Fixed %	Fixed Cost USD/a	Variable USD/a
	USD/a	USD/lb Cu Eq			
Power	\$21,120,584	\$0.19	15.0	\$3,168,088	\$17,952,497
Consumables	\$12,086,191	\$0.11	5.0	\$604,310	\$11,481,881
Reagents	\$42,097,076	\$0.37	0.0	\$0	\$42,097,076
Labour	\$5,879,177	\$0.05	100.0	\$5,879,177	\$0
Maintenance	\$4,671,446	\$0.04	15.0	\$700,717	\$3,970,729
Misc	\$1,200,000	\$0.01	100.0	\$1,200,000	\$0
<b>Total</b>	<b>\$87,054,475</b>	<b>\$0.77</b>	<b>13.3</b>	<b>\$11,552,292</b>	<b>\$75,502,183</b>

Summary 1 - Cost per tonne of Concentrate (Based on Commodity)					
	Cost		Fixed Cost USD/a	Variable USD/a	Overall Distribution %
	USD/a	USD/t ROM			
Power	\$21,120,584	\$1.06	\$3,168,088	\$17,952,497	24.3
Consumables	\$12,086,191	\$0.60	\$604,310	\$11,481,881	13.9
Reagents	\$42,097,076	\$2.10	\$0	\$42,097,076	48.4
Labour	\$5,879,177	\$0.29	\$5,879,177	\$0	6.8
Maintenance	\$4,671,446	\$0.23	\$700,717	\$3,970,729	5.4
Miscellaneous	\$1,200,000	\$0.06	\$1,200,000	\$0	1.4
<b>Total</b>	<b>\$87,054,475</b>	<b>\$4.35</b>	<b>\$11,552,292</b>	<b>\$75,502,183</b>	<b>100.0</b>

Reagents					
	Price USD/unit	Unit	Consumption (unit/a)	Cost	
				USD/a	USD/t ROM
Sulphuric Acid	\$275	t	18926	\$6,056,391	0.30
Polycrylamide	\$2,150	t	2933	\$6,437,902	0.32
LIX984N	\$12,000	t	548	\$6,605,986	0.33
Quicklime	\$300	t	14418	\$4,974,071	0.25
Limestone	\$150	t	67327	\$13,128,672	0.66
Calcicrete/Dolomite	\$13	t	0	\$0	0.00
Kerosene	\$550	t	3108	\$1,849,184	0.09
Raw Water	\$1	kL	2370234	\$2,171,105	0.11
Flocculant	\$2,150	t	127	\$271,833	0.01
Diesel	\$1	L	600000	\$594,943	0.03
<b>Total</b>				<b>\$42,097,076</b>	<b>\$2.10</b>

Maintenance				
	Mechanical Capital USD	Maintenance %	Cost	
			USD/a	USD/t ROM
Crushing	\$33,812,000	5%	\$1,690,600	\$0.08
HPGR	\$24,532,000	5%	\$1,226,600	\$0.06
Agglomeration and Heap Leaching	\$25,049,000	1%	\$250,490	\$0.01
Copper SX and EW	\$41,326,000	3%	\$1,239,780	\$0.06
Iron Removal and Tailings	\$3,613,000	3%	\$108,390	\$0.01
Process and Raw Water	\$2,343,000	1%	\$23,430	\$0.00
Reagents	\$2,772,200	3%	\$83,166	\$0.00
Services	\$1,633,000	3%	\$48,990	\$0.00
<b>Total</b>	<b>\$135,080,200</b>	<b>3.46%</b>	<b>\$4,671,446</b>	<b>\$0.23</b>

Plant Standby Cost				
	Assumptions and Bases	% of annual total cost	Standby Cost USD/a	Dist %
Consumables	Air and water service costs persist	5.0	\$604,310	5.2
Reagents	No reagent consumption due to no throughput	0.0	\$0	0.0
Labour	All staff retain their positions	100.0	\$5,879,177	50.9
Maintenance	Operational equipment maintenance	15.0	\$700,717	6.1
Miscellaneous	Contract agreements	100.0	\$1,200,000	10.4
<b>Total</b>		<b>13.3</b>	<b>\$11,552,292</b>	<b>100.0</b>

Power						
	Installed kW	Utilisation %	kW Draw	Total kWh/a	Cost	
					USD/a	USD/t ROM
Crushing	7,072	70	4,950	30,355,149	\$2,560,882	\$0.13
HPGR	8,607	90	7,746	61,071,829	\$5,152,272	\$0.26
Agglomeration and Heap Leaching	3,808	98	3,732	32,036,730	\$2,702,747	\$0.14
Copper SX and EW	17,065	90	15,359	121,089,907	\$10,215,629	\$0.51
Iron Removal and Tailings	313	90	281	2,219,131	\$187,215	\$0.01
Process and Raw Water	451	90	406	3,199,140	\$269,892	\$0.01
Reagents	31	90	28	221,681	\$18,702	\$0.00
Services	28	70	20	157,007	\$13,246	\$0.00
<b>Total</b>	<b>37,376</b>		<b>32,523</b>	<b>250,350,674</b>	<b>\$21,120,584</b>	<b>\$1.06</b>

Consumables					
	Unit	Price USD/unit	Consumption (unit/a)	Cost	
				USD/a	USD/t ROM
Gyratory Crusher Liner - Mantle	set	\$200,000.00	4	\$800,000	\$72,000
Gyratory Crusher Liner - Concave	set	\$200,000.00	8	\$1,600,000	\$144,000
Cone Crusher Liners - Bowl	set	\$18,000.00	12	\$216,000	\$19,440
Cone Crusher Liners - Mantle	set	\$18,000.00	12	\$216,000	\$19,440
Secondary Screen	set	\$20,000.00	8	\$160,000	\$14,400
HPGR Liner and Plates	set	\$1,149,512.00	1	\$574,756	\$51,728
HPGR Double Deck Screen Liner	set	\$25,000.00	16	\$400,000	\$36,000
Pad Clearance	m2	\$0.65	354918	\$230,697	\$0.01
Pad Leveling	m3	\$2.50	632023	\$1,580,058	\$0.08
Pad Liner	m2	\$8.40	364918	\$2,981,312	\$268,318
Irrigation Tubing	m	\$7.00	5384	\$37,685	\$3,392
Cathode	set	\$150.00	2947	\$442,800	\$39,787
Anode	set	\$200.00	3684	\$736,800	\$66,312
Oil	t	\$900.00	926	\$833,333	\$75,000
Grease	t	\$450.00	926	\$416,667	\$37,500
Air Filters	set	\$3,745.28	1	\$1,873	\$169
Mobile Lighting Tower Parts	set	\$700.00	3	\$2,100	\$189
Light Vehicle Parts	set	\$350.00	6	\$2,100	\$189
Water Truck Parts	set	\$2,100.00	1	\$2,100	\$189
Forklift Parts	set	\$1,750.00	2	\$3,500	\$315
Ambulance Parts/Consumables	set	\$700.00	1	\$700	\$63
<b>Total</b>				<b>\$12,086,191</b>	<b>\$0.60</b>

Key Inputs and Outputs		
Plant Throughput dry	20,000,000	tpa
Utilisation (Crushing)	6,132	h/a
Utilisation (Grinding)	7,864	h/a
Plant Throughput dry	2,537	dtp/h
Head Grade	0.310%	% Cu
Recovery	84.9	% Cu
Annual Production	\$1,077	t Cu
	112,606,047	lb Cu
Power Cost	\$0.084	USD/kWh
Total Power	12.52	kWh/t
Abrasion Index	0.49	
Fixed Component	\$11,552,292	USD/a
Fixed Component	\$0.58	USD/t ROM
Variable Component	\$75,502,183	USD/a
Variable Component	\$3.78	USD/t ROM
<b>Operating Cost Estimation</b>	<b>\$4.35</b>	<b>USD/t ROM</b>
<b>Operating Cost Estimation</b>	<b>\$0.77</b>	<b>USD/lb Cu Eq</b>

Miscellaneous Costs Only		
	Cost	
	USD/a	USD/t ROM
Laboratory Costs	\$1,000,000	\$0.05
Contractors	\$100,000	\$0.01
Vehicle Fleet	\$100,000	\$0.01
<b>Total</b>	<b>\$1,200,000</b>	<b>\$0.06</b>

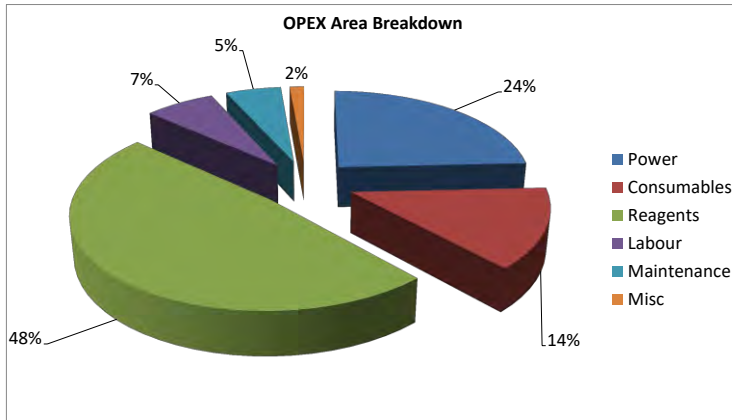

Rev	Date	Engineer	Comments
0	13/03/20	DC	Issue as draft to client
A	10/01/20	LZ	Began populating updated layout

Key Input	Only Adjust variables in Blue	Source of information
Throughput (tph)	2537	Calculation
Throughput (tpa)	20,000,000	Basis value
Availability (Crushing)	70%	METS assumed value
Availability (Grinding)	90%	METS assumed value
Operating Hour pa (Crushing)	6132	Calculation
Operating Hour pa (Grinding)	7884	Calculation
Exchange rate (1 NAD = 0.07 USD)	\$0.07	<a href="http://www.xe.com">www.xe.com</a>

Price List	Units	Price USD/unit	Source of information
Gyratory Crusher Liner - Mantle	set	\$150,000	
Gyratory Crusher Liner - Concave	set	\$150,000	
Cone Crusher Liners - Bowl	set	\$18,000	
Cone Crusher Liners - Mantle	set	\$18,000	
Secondary Screen	set	\$20,000	
HPGR Liner and Plates	set	\$1,149,512	Koppers
HPGR Double Deck Screen Liner	set	\$25,000	
Pad Liner	m <sup>2</sup>	\$8.4	
Irrigation Tubing	m	\$7	
Oil	t	\$900	
Grease	t	\$450	
Air Filters	set	\$3,745	
Mobile Lighting Tower Parts	set	\$700	
Light Vehicle Parts	set	\$350	
Water Truck Parts	set	\$2,100	
Forklift Parts	set	\$1,750	
Ambulance Parts/Consumables	set	\$700	
Sulphuric Acid	t	\$275.00	DAP Noordoewer
Polyacrylamide	t	\$2,150.00	DAP Noordoewer
LIX984N	t	\$12,000	
Quicklime	t	\$300	
Limestone	t	\$150	
Calcrete/Dolomite	t	\$12.50	Assumption, mining cost+crushing cost
Kerosene	t	\$550	
Raw Water	kL	\$0.92	Calculation
Flocculant	t	\$2,150	DAP Noordoewer
Diesel	L	\$0.94	globalpetrolprices.com
Cathode	set	\$150.00	
Anode	set	\$200.00	
Power Cost (N\$)	kWh	\$1.21	
Power Cost (US\$)	kWh	\$0.084	Calculation

\*Manipulation of the mass balance worksheet will automatically update the OPEX model



**Document** OPEX-20 Mtpa @ 85% Cu Recovery  
**Area** Labour  
**Client** Deep-South Resources  
**Project** Haib PEA  
**Job #** J5329  
**Doc #** J5329-ES-CA-000-001  
**Rev** A

Personnel	Annual Salary (N\$)	Annual Salary (USD)	Roster	Shift or D/N (D)	#	Total Cost (USD) per Annum	USD/t ROM	Crushing	Agglomeration and Heap Leaching	Copper SX and EW	Iron Removal and Tailings	Process and Raw Water	Reagents	Services		
<b>Process Plant</b>																
General Manager	\$2,255,964	\$157,917	Full Time	D	1	\$157,917	\$0.01	\$0.00	\$0.00	\$0.00	\$0.00	\$0.00	\$0.00	\$0.00		
Personal Assistant	\$296,184	\$20,733	Full Time	D	1	\$20,733	\$0.00	\$0.00	\$0.00	\$0.00	\$0.00	\$0.00	\$0.00	\$0.00		
<b>Processing</b>																
Process Manager	\$1,253,128	\$87,719	Full Time	D	1	\$87,719	\$0.00	\$0.00	\$0.00	\$0.00	\$0.00	\$0.00	\$0.00	\$0.00		
Plant Superintendent/Supervisor	\$1,123,128	\$78,619	Full Time	D	1	\$78,619	\$0.00	\$0.00	\$0.00	\$0.00	\$0.00	\$0.00	\$0.00	\$0.00		
Shift Supervisor	\$1,123,128	\$78,619	Full Time	D	1	\$78,619	\$0.00	\$0.00	\$0.00	\$0.00	\$0.00	\$0.00	\$0.00	\$0.00		
Plant Operator	\$296,184	\$20,733	4/3 DIDO	D/N	68	\$1,409,836	\$0.07	\$0.02	\$0.02	\$0.01	\$0.01	\$0.00	\$0.00	\$0.00		
Day Crew / Cleanup	\$296,184	\$20,733	4/3 DIDO	D	4	\$82,932	\$0.00	\$0.00	\$0.00	\$0.00	\$0.00	\$0.00	\$0.00	\$0.00		
Senior Metallurgist	\$1,253,128	\$87,719	4/3 DIDO	D	2	\$175,438	\$0.01	\$0.00	\$0.00	\$0.00	\$0.00	\$0.00	\$0.00	\$0.00		
Metallurgist / Process Engineer	\$1,123,128	\$78,619	4/3 DIDO	D	2	\$157,238	\$0.01	\$0.00	\$0.00	\$0.00	\$0.00	\$0.00	\$0.00	\$0.00		
Graduate Metallurgist	\$691,452	\$48,402	4/3 DIDO	D	2	\$96,803	\$0.00	\$0.00	\$0.00	\$0.00	\$0.00	\$0.00	\$0.00	\$0.00		
Metallurgical Accounting Clerk	\$691,452	\$48,402	4/3 DIDO	D	2	\$96,803	\$0.00	\$0.00	\$0.00	\$0.00	\$0.00	\$0.00	\$0.00	\$0.00		
Electrical/Process Control Engineer	\$1,253,128	\$87,719	4/3 DIDO	D	2	\$175,438	\$0.01	\$0.00	\$0.00	\$0.00	\$0.00	\$0.00	\$0.00	\$0.00		
Chief Chemist	\$1,253,128	\$87,719	Full Time	D	1	\$87,719	\$0.00	\$0.00	\$0.00	\$0.00	\$0.00	\$0.00	\$0.00	\$0.00		
Chemist	\$691,452	\$48,402	4/3 DIDO	D	1	\$48,402	\$0.00	\$0.00	\$0.00	\$0.00	\$0.00	\$0.00	\$0.00	\$0.00		
Laboratory Technician	\$480,516	\$33,636	4/3 DIDO	D	2	\$67,272	\$0.00	\$0.00	\$0.00	\$0.00	\$0.00	\$0.00	\$0.00	\$0.00		
<b>Maintenance</b>																
Maintenance Manager	\$1,253,128	\$87,719	Full Time	D	1	\$87,719	\$0.00	\$0.00	\$0.00	\$0.00	\$0.00	\$0.00	\$0.00	\$0.00		
Reliability Engineer	\$976,536	\$68,358	Full Time	D	1	\$68,358	\$0.00	\$0.00	\$0.00	\$0.00	\$0.00	\$0.00	\$0.00	\$0.00		
Mechanical Supervisor	\$691,452	\$48,402	4/3 DIDO	D	2	\$96,803	\$0.00	\$0.00	\$0.00	\$0.00	\$0.00	\$0.00	\$0.00	\$0.00		
Fitter	\$480,516	\$33,636	4/3 DIDO	D	3	\$100,908	\$0.01	\$0.00	\$0.00	\$0.00	\$0.00	\$0.00	\$0.00	\$0.00		
Boilermaker	\$480,516	\$33,636	4/3 DIDO	D	3	\$100,908	\$0.01	\$0.00	\$0.00	\$0.00	\$0.00	\$0.00	\$0.00	\$0.00		
Fitter / Boilermaker Apprentice	\$296,184	\$20,732.88	4/3 DIDO	D	5	\$103,664	\$0.01	\$0.00	\$0.00	\$0.00	\$0.00	\$0.00	\$0.00	\$0.00		
Trades Assisstant / Tool Storeman	\$338,772	\$23,714	4/3 DIDO	D	3	\$71,142	\$0.00	\$0.00	\$0.00	\$0.00	\$0.00	\$0.00	\$0.00	\$0.00		
Electrician	\$542,556	\$37,979	4/3 DIDO	D/N	6	\$227,874	\$0.01	\$0.00	\$0.00	\$0.00	\$0.00	\$0.00	\$0.00	\$0.00		
Instrumentation Technician	\$542,556	\$37,979	4/3 DIDO	D	2	\$75,958	\$0.00	\$0.00	\$0.00	\$0.00	\$0.00	\$0.00	\$0.00	\$0.00		
Electrical Apprentice	\$296,184	\$20,733	4/3 DIDO	D	2	\$41,466	\$0.00	\$0.00	\$0.00	\$0.00	\$0.00	\$0.00	\$0.00	\$0.00		
<b>Administration</b>																
Administration Manager	\$1,123,128	\$78,619	Full Time	D	1	\$78,619	\$0.00	\$0.00	\$0.00	\$0.00	\$0.00	\$0.00	\$0.00	\$0.00		
Senior Accountant	\$1,123,128	\$78,619	Full Time	D	1	\$78,619	\$0.00	\$0.00	\$0.00	\$0.00	\$0.00	\$0.00	\$0.00	\$0.00		
Reception and General Office	\$338,772	\$23,714	Full Time	D	1	\$23,714	\$0.00	\$0.00	\$0.00	\$0.00	\$0.00	\$0.00	\$0.00	\$0.00		
IT Officer	\$1,123,128	\$78,619	Full Time	D	1	\$78,619	\$0.00	\$0.00	\$0.00	\$0.00	\$0.00	\$0.00	\$0.00	\$0.00		
Shipping and Purchasing Officer	\$1,123,128	\$78,619	Full Time	D	1	\$78,619	\$0.00	\$0.00	\$0.00	\$0.00	\$0.00	\$0.00	\$0.00	\$0.00		
HR Superintendent	\$1,123,128	\$78,619	Full Time	D	1	\$78,619	\$0.00	\$0.00	\$0.00	\$0.00	\$0.00	\$0.00	\$0.00	\$0.00		
<b>Environmental and OH&amp;S</b>																
Environment, Health and Safety Manager	\$1,123,128	\$78,619	Full Time	D	1	\$78,619	\$0.00	\$0.00	\$0.00	\$0.00	\$0.00	\$0.00	\$0.00	\$0.00		
Environmental Officer	\$691,452	\$48,402	Full Time	D	1	\$48,402	\$0.00	\$0.00	\$0.00	\$0.00	\$0.00	\$0.00	\$0.00	\$0.00		
Safety and Training Co-ordinator	\$1,123,128	\$78,618.96	Full Time	D	1	\$78,619	\$0.00	\$0.00	\$0.00	\$0.00	\$0.00	\$0.00	\$0.00	\$0.00		
OH&S Technician	\$691,452	\$48,402	Full Time	D	1	\$48,402	\$0.00	\$0.00	\$0.00	\$0.00	\$0.00	\$0.00	\$0.00	\$0.00		
Emergency Response Co-ordinator	\$542,556	\$37,979	Full Time	D	1	\$37,979	\$0.00	\$0.00	\$0.00	\$0.00	\$0.00	\$0.00	\$0.00	\$0.00		
<b>On Costs -General</b>						\$1,374,061	\$0.07	\$0.02	\$0.02	\$0.01	\$0.01	\$0.00	\$0.00	\$0.00		
<b>On Costs - Messing</b>						\$0	\$0.00	\$0.00	\$0.00	\$0.00	\$0.00	\$0.00	\$0.00	\$0.00		
% Split								100%	30%	25%	15%	15%	5%	5%		
<b>Total</b>							<b>130</b>	<b>\$5,879,177</b>	<b>\$0.29</b>	<b>\$0.09</b>	<b>\$0.07</b>	<b>\$0.04</b>	<b>\$0.04</b>	<b>\$0.01</b>	<b>\$0.01</b>	<b>\$0.01</b>



**Document** OPEX-20 Mtpa @ 85% Cu Recovery  
**Area** Consumables  
**Client** Deep-South Resources  
**Project** Haib PEA  
**Job #** J5329  
**Doc #** J5329-ES-CA-000-001  
**Rev** A

Concentrator Area/ Equipment Name	Cost (USD) per unit	Unit	Consumption Rate/Unit/Year	Number of Units	Total quantity per Year	Total Cost (USD) per Annum	Estimated Freight Cost	Total Cost (USD) per Annum	USD/t ROM
<b>Crushing</b>									
Gyratory Crusher Liner - Mantle	\$200,000	set	2	1	4	\$800,000	\$72,000	\$872,000	\$0.04
Gyratory Crusher Liner - Concave	\$200,000	set	4	1	8	\$1,600,000	\$144,000	\$1,744,000	\$0.09
Cone Crusher Liners - Bowl	\$18,000	set	3	2	12	\$216,000	\$19,440	\$235,440	\$0.01
Cone Crusher Liners - Mantle	\$18,000	set	3	2	12	\$216,000	\$19,440	\$235,440	\$0.01
Secondary Screen	\$20,000	set	4	2	8	\$160,000	\$14,400	\$174,400	\$0.01
HPGR Liner and Plates	\$1,149,512	set	0.3	2	0.5	\$574,756	\$51,728	\$626,484	\$0.03
HPGR Double Deck Screen Liner	\$25,000	set	8	2	16	\$400,000	\$36,000	\$436,000	\$0.02
<b>Sub total - Crushing and Grinding</b>						<b>\$3,966,756</b>	<b>\$357,008</b>	<b>\$4,323,764</b>	<b>\$0.22</b>
<b>Agglomeration and Heap Leaching</b>									
Pad Clearance	\$1	m2	354918	1	354918	\$230,697		\$230,697	\$0.01
Pad Leveling	\$3	m3	632023	1	632023	\$1,580,058		\$1,580,058	\$0.08
Pad Liner	\$8	m2	354918	1	354918	\$2,981,312	\$268,318.08	\$3,249,630	\$0.16
Irrigation Tubing	\$7	m	1795	3	5384	\$37,685	\$3,392	\$41,076	\$0.00
<b>Sub total - Agglomeration and Heap Leach</b>						<b>\$4,829,752</b>	<b>\$271,710</b>	<b>\$5,101,461</b>	<b>\$0.26</b>
<b>Electrowinning</b>									
Cathode	\$150	set	2947	1	2947	\$442,080	\$39,787	\$481,867	\$0.02
Anode	\$200	set	3684	1	3684	\$736,800	\$66,312	\$803,112	\$0.04
<b>Sub total - Electrowinning</b>						<b>\$1,178,880</b>	<b>\$106,099</b>	<b>\$1,284,979</b>	<b>\$0.06</b>
<b>Services</b>									
Oil	\$900	t	2.54	365	926	\$833,333	\$75,000	\$908,333	\$0.05
Grease	\$450	t	2.54	365	926	\$416,667	\$37,500	\$454,167	\$0.02
Air Filters	\$3,745	set	1	1	1	\$1,873	\$169	\$2,041	\$0.00
<b>Sub total - Services</b>						<b>\$1,251,873</b>	<b>\$112,669</b>	<b>\$1,364,541</b>	<b>\$0.07</b>
<b>Misc</b>									
Mobile Lighting Tower Parts	\$700	set	1	3	3	\$2,100	\$189	\$2,289	\$0.00
Light Vehicle Parts	\$350	set	1	6	6	\$2,100	\$189	\$2,289	\$0.00
Water Truck Parts	\$2,100	set	1	1	1	\$2,100	\$189	\$2,289	\$0.00
Forklift Parts	\$1,750	set	1	2	2	\$3,500	\$315	\$3,815	\$0.00
Ambulance Parts/Consumables	\$700	set	1	1	1	\$700	\$63	\$763	\$0.00
<b>Sub total - Misc</b>						<b>\$10,500</b>	<b>\$945</b>	<b>\$11,445</b>	<b>\$0.00</b>
<b>Total</b>						<b>\$11,237,760</b>	<b>\$848,430</b>	<b>\$12,086,191</b>	<b>\$0.60</b>



Document  
Area  
Client  
Project  
Job #  
Doc #  
Rev

OPEX-20 Mtpa @ 85% Cu Recovery  
Reagents  
Deep-South Resources  
Haib PEA  
J5329  
J5329-ES-CA-000-001  
A

Reagents	USD per unit CIF Luderitz	Unit	Consumed per Year	Reagent Cost (USD) per Annum	Transport Cost (USD) Port to Haib	Total Cost (USD) per Annum	USD/t ROM
Sulphuric Acid	\$275	t	18,926	5,204,711	851,680	\$6,056,391	\$0.30
Polyacrylamide	\$2,150	t	2,933	6,305,917	131,984	\$6,437,902	\$0.32
LIX984N	\$12,000	t	548	6,581,306	24,680	\$6,605,986	\$0.33
Quicklime	\$300	t	14,418	4,325,279	648,792	\$4,974,071	\$0.25
Limestone	\$150	t	67,327	10,098,978	3,029,693	\$13,128,672	\$0.66
Calcrete/Dolomite	\$12.5	t	0	0		\$0	\$0.00
Kerosene	\$550	t	3,108	1,709,311	139,853	\$1,849,164	\$0.09
Raw Water	\$0.92	kL	2,370,234	2,171,845	0	\$2,171,845	\$0.11
Flocculant	\$2,150	t	127	272,402	5,701	\$278,103	\$0.01
Diesel	\$0.94	L	600,000	562,800	32,143	\$594,943	\$0.03
<b>Total</b>						<b>\$42,097,076</b>	<b>\$2.10</b>

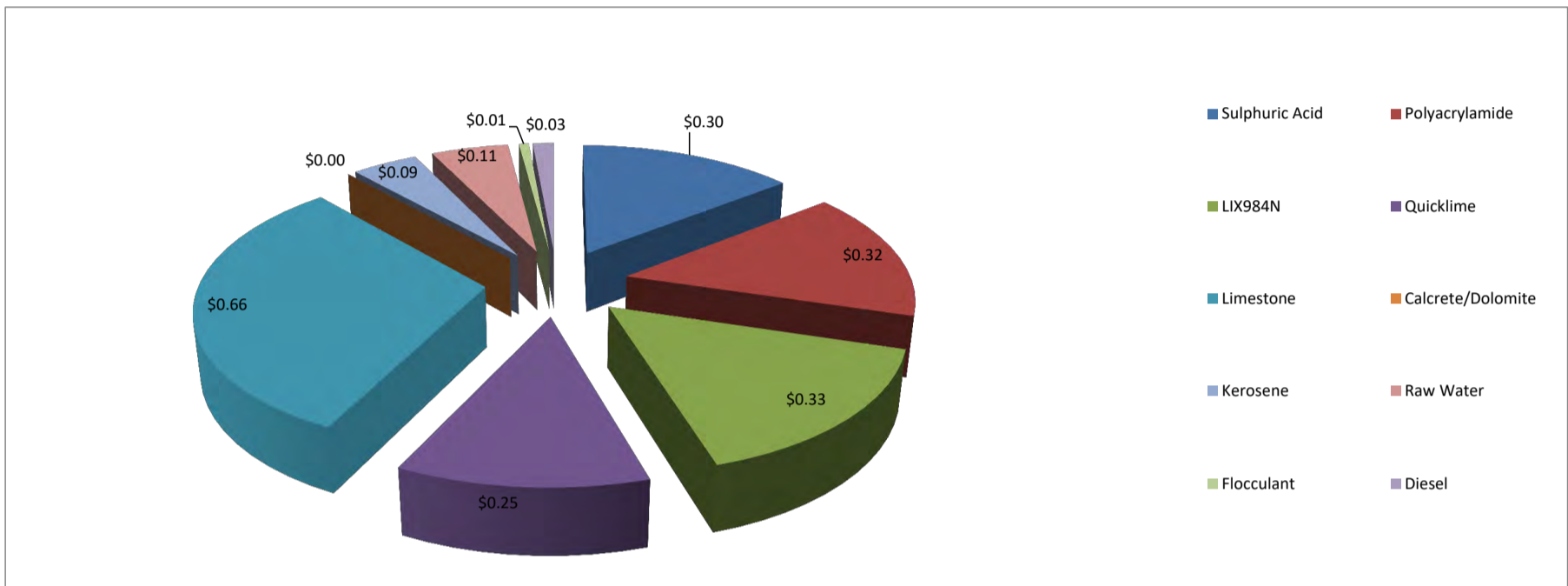





**Document** OPEX-20 Mtpa @ 85% Cu Recovery  
**Area** Power  
**Client** Deep-South Resources  
**Project** Haib PEA  
**Job #** J5329  
**Doc #** J5329-ES-CA-000-001  
**Rev** A

Concentrator Area/ Equipment Name	Installed Power (kW)	Utilisation %	Power Draw (kW)	Operating Hours	Consumption (kWhpa)	Total Cost (USD) per Annum	USD/t ROM
Crushing	7,072	70	4950	6,132	30,355,149	\$2,560,882	\$0.13
HPGR	8,607	90	7746	7,884	61,071,929	\$5,152,272	\$0.26
Agglomeration and Heap Leaching	3,808	98	3732	8,585	32,036,730	\$2,702,747	\$0.14
Copper SX and EW	17,065	90	15359	7,884	121,089,907	\$10,215,629	\$0.51
Iron Removal and Tailings	313	90	281	7,884	2,219,131	\$187,215	\$0.01
Process and Raw Water	451	90	406	7,884	3,199,140	\$269,892	\$0.01
Reagents	31	90	28	7,884	221,681	\$18,702	\$0.00
Services	28	70	20	7,884	157,007	\$13,246	\$0.00
<b>Total</b>	<b>37,376</b>		<b>32,523</b>		<b>250,350,674</b>	<b>\$21,120,584</b>	<b>\$1.06</b>

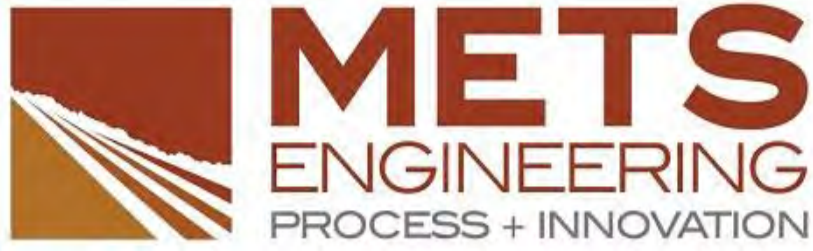

**Document** OPEX-20 Mtpa @ 85% Cu Recovery  
**Area** Maintenance  
**Client** Deep-South Resources  
**Project** Haib PEA  
**Job #** J5329  
**Doc #** J5329-ES-CA-000-001  
**Rev** A

Area	Mechanical CAPEX (USD)	Maintenance Cost (%)	Maintenance Cost per year (USD)	USD/t ROM
Crushing	\$33,812,000	5%	\$1,690,600	\$0.08
HPGR	\$24,532,000	5%	\$1,226,600	\$0.06
Agglomeration and Heap Leaching	\$25,049,000	1%	\$250,490	\$0.01
Copper SX and EW	\$41,326,000	3%	\$1,239,780	\$0.06
Iron Removal and Tailings	\$3,613,000	3%	\$108,390	\$0.01
Process and Raw Water	\$2,343,000	1%	\$23,430	\$0.00
Reagents	\$2,772,200	3%	\$83,166	\$0.00
Services	\$1,633,000	3%	\$48,990	\$0.00
<b>Total</b>	<b>\$135,080,200</b>		<b>\$4,671,446</b>	<b>\$0.23</b>



## DOCUMENT COVER SHEET

**CLIENT:** Deep-South Resources

**PROJECT TITLE:** Haib PEA

**PROJECT NO.:** J5329

**DOCUMENT TITLE:** OPEX-20 Mtpa @ 85% Cu Recovery +CuSO4

**DOCUMENT NO:** J5329-ES-CA-000-001

**Option Description:** Whole Ore Heap Leach

THIS DOCUMENT HAS BEEN PREPARED AND CHECKED IN ACCORDANCE WITH THE FOLLOWING WORK INSTRUCTIONS / CHECKLISTS TO THE NOMINATED CHECKING METHOD & LEVEL.				
CHECKING METHOD		CHECKING LEVEL		
WORK INSTRUCTION / CHECKLIST NO.		OR	CH	
NAME		DATE		
OR				
CH				

0	13/03/20	Issue as draft to client	DC		
A	6/03/20	Began populating updated layout	LZ	BM	
<b>Rev</b>	<b>Date</b>	<b>Revision</b>	<b>By</b>	<b>Ch'k</b>	<b>L.E.</b>



Title: OPEX-20 Mpa @ 85% Cu Recovery +CuSO4  
 Document No.: J5329-ES-CA-000-001  
 Project: Half PEA  
 Client: Deep-South Resources  
 Date: 06-Mar-20  
 Rev: A  
 Option: Whole Ore Heap Leach  
 Accuracy: ± 30%  
 Comments:

Key Inputs and Outputs			
Plant Throughput dry	20,000,000	tpa	
Utilisation (Crushing)	6.132	h/a	
Utilisation (Grinding)	7.884	h/a	
Plant Throughput dry	2,537	dtp/h	
Head Grade	0.310%	% Cu	
Recovery	85	% Cu	
Annual Production	38,337	t Cu	
	84,518,099	lb Cu	
	51,081	t CuSO4.5H2O	
	112,613,875	lb CuSO4.5H2O	
	120,344,334	Total lb Cu Eq	
Power Cost	\$0.084	USD/kWh	
Total Power	11.36	kWh/t	
Abrasion Index	0.49		
Fixed Component	\$11,317,331	USD/a	
Fixed Component	\$0.57	USD/t ROM	
Variable Component	\$84,267,931	USD/a	
Variable Component	\$4.21	USD/t ROM	
<b>Operating Cost Estimation</b>	<b>\$4.78</b>	<b>USD/t ROM</b>	
<b>Operating Cost Estimation</b>	<b>\$0.79</b>	<b>USD/lb Cu Eq</b>	

Miscellaneous Costs Only		
	Cost	
	USD/a	USD/t ROM
Laboratory Costs	\$1,000,000	\$0.05
Contractors	\$100,000	\$0.01
Vehicle Fleet	\$100,000	\$0.01
<b>Total</b>	<b>\$1,200,000</b>	<b>\$0.06</b>

Summary 1 - Cost per pound of copper produced (Based on Commodity)					
	Cost		Fixed %	Fixed Cost USD/a	Variable USD/a
	USD/a	USD/lb Cu Eq			
Power	\$19,162,721	\$0.16	15.0	\$2,874,408	\$16,288,313
Consumables	\$13,194,092	\$0.11	5.0	\$659,705	\$12,534,388
Reagents	\$51,455,665	\$0.43	0.0	\$0	\$51,455,665
Labour	\$5,879,177	\$0.05	100.0	\$5,879,177	\$0
Maintenance	\$4,693,606	\$0.04	15.0	\$704,041	\$3,989,565
Misc	\$1,200,000	\$0.01	100.0	\$1,200,000	\$0
<b>Total</b>	<b>\$95,585,262</b>	<b>\$0.79</b>	<b>11.8</b>	<b>\$11,317,331</b>	<b>\$84,267,931</b>

Summary 1 - Cost per tonne of Concentrate (Based on Commodity)					
	Cost		Fixed Cost USD/a	Variable USD/a	Overall Distribution %
	USD/a	USD/t ROM			
Power	\$19,162,721	\$0.96	\$2,874,408	\$16,288,313	20.0
Consumables	\$13,194,092	\$0.66	\$659,705	\$12,534,388	13.8
Reagents	\$51,455,665	\$2.57	\$0	\$51,455,665	53.8
Labour	\$5,879,177	\$0.29	\$5,879,177	\$0	6.2
Maintenance	\$4,693,606	\$0.23	\$704,041	\$3,989,565	4.9
Miscellaneous	\$1,200,000	\$0.06	\$1,200,000	\$0	1.3
<b>Total</b>	<b>\$95,585,262</b>	<b>\$4.78</b>	<b>\$11,317,331</b>	<b>\$84,267,931</b>	<b>100.0</b>

Reagents					
	Price USD/unit	Unit	Consumption (unit/a)	Cost	
				USD/a	USD/t ROM
Sulphuric Acid	\$275	t	37607	\$10,342,277	0.60
Polyacrylamide	\$2,150	t	2927	\$6,423,317	0.32
LIX84N	\$12,000	t	548	\$6,605,986	0.33
Quicklime	\$300	t	14418	\$4,374,071	0.25
Limestone	\$150	t	67327	\$10,102,672	0.66
Calcite/Dolomite	\$13	t	0	\$0	0.00
Kerosene	\$550	t	3108	\$1,710,450	0.09
Raw Water	\$1	kL	2477021	\$2,269,694	0.11
Flocculant	\$2,150	t	127	\$276,103	0.01
Diesel	\$1	L	3923449	\$3,890,380	0.19
<b>Total</b>				<b>\$51,455,665</b>	<b>\$2.57</b>

Maintenance					
	Mechanical Capital USD	Maintenance %	Cost		
			USD/a	USD/t ROM	USD/t ROM
Crushing	\$33,812,000	5%	\$1,690,600	\$0.08	
HPGR	\$24,532,000	5%	\$1,226,600	\$0.06	
Agglomeration and Heap Leaching	\$25,049,000	1%	\$250,490	\$0.01	
Copper SX and EW	\$41,908,000	3%	\$1,257,240	\$0.06	
Iron Removal and Tailings	\$3,813,000	3%	\$108,390	\$0.01	
Process and Raw Water	\$2,357,000	1%	\$23,570	\$0.00	
Reagents	\$2,924,200	3%	\$87,726	\$0.00	
Services	\$1,833,000	3%	\$48,990	\$0.00	
<b>Total</b>	<b>\$135,829,200</b>	<b>3.46%</b>	<b>\$4,693,606</b>	<b>\$0.23</b>	

Plant Standby Cost					
	Assumptions and Bases		% of annual total cost	Standby Cost USD/a	Dist %
Power	Agitators, thickeners and lighting persist		15.0	\$2,874,408	25.4
Consumables	Air and water service costs persist		5.0	\$659,705	5.8
Reagents	No reagent consumption due to no throughput		0.0	\$0	0.0
Labour	All staff retain their positions		100.0	\$5,879,177	51.9
Maintenance	Operational equipment maintenance		15.0	\$704,041	6.2
Miscellaneous	Contract agreements		100.0	\$1,200,000	10.6
<b>Total</b>			<b>11.8</b>	<b>\$11,317,331</b>	<b>100.0</b>

Power						
	Installed kW	Utilisation %	kW Draw	Total kWh/a	Cost	
					USD/a	USD/t ROM
Crushing	7,072	70	4,950	30,355,149	\$2,560,892	\$0.13
HPGR	8,607	90	7,746	61,071,929	\$5,152,272	\$0.26
Agglomeration and Heap Leaching	3,808	98	3,732	32,036,730	\$2,702,747	\$0.14
Copper SX and EW	13,785	90	12,407	97,814,727	\$8,252,042	\$0.41
Iron Removal and Tailings	313	90	281	2,219,131	\$187,215	\$0.01
Process and Raw Water	452	90	407	3,269,730	\$270,766	\$0.01
Reagents	39	90	35	278,942	\$23,533	\$0.00
Services	28	70	20	157,007	\$13,246	\$0.00
<b>Total</b>	<b>34,105</b>		<b>29,579</b>	<b>227,143,346</b>	<b>\$19,162,721</b>	<b>\$0.96</b>

Consumables						
	Unit	Price USD/unit	Consumption (unit/a)	Cost		
				USD/a	Freight	USD/t ROM
Gyratory Crusher Liner - Mantle	set	\$200,000.00	4	\$800,000	\$72,000	\$0.04
Gyratory Crusher Liner - Concave	set	\$200,000.00	8	\$1,600,000	\$144,000	\$0.09
Cone Crusher Liners - Bowl	set	\$18,000.00	12	\$216,000	\$19,440	\$0.01
Cone Crusher Liners - Mantle	set	\$18,000.00	12	\$216,000	\$19,440	\$0.01
Secondary Screen	set	\$20,000.00	8	\$160,000	\$14,400	\$0.01
HPGR Liner and Plates	set	\$1,149,512.00	1	\$574,756	\$51,728	\$0.03
HPGR Double Deck Screen Liner	set	\$25,000.00	16	\$400,000	\$36,000	\$0.02
Pad Clearance	m2	\$0.65	354918	\$230,697	\$0.01	
Pad Earthworks	m3	\$2.50	630023	\$1,590,058	\$0.08	
Pad Liner	m2	\$8.40	354918	\$2,981,312	\$268,318	\$0.16
Irrigation Tubing	m	\$7.00	5384	\$37,685	\$3,392	\$0.00
Replacement Cathodes	set	\$150.00	2259	\$338,820	\$30,494	\$0.02
Replacement Anodes	set	\$200.00	2259	\$451,760	\$40,658	\$0.02
Copper Sulfate Bags	each	\$12.50	51081	\$638,511	\$57,466	\$0.03
Copper Sulfate Pallets	each	\$15.00	51081	\$766,213	\$68,959	\$0.04
Oil	t	\$900.00	926	\$833,333	\$75,000	\$0.05
Grease	t	\$450.00	926	\$416,667	\$37,500	\$0.02
Air Filters	set	\$3,745.28	1	\$1,873	\$169	\$0.00
Mobile Lighting Tower Parts	set	\$700.00	3	\$2,100	\$189	\$0.00
Light Vehicle Parts	set	\$350.00	6	\$2,100	\$189	\$0.00
Water Truck Parts	set	\$2,100.00	1	\$2,100	\$189	\$0.00
Forklift Parts	set	\$1,750.00	2	\$3,500	\$315	\$0.00
Ambulance Parts/Consumables	set	\$700.00	1	\$700	\$63	\$0.00
<b>Total</b>					<b>\$13,194,092</b>	<b>\$0.66</b>

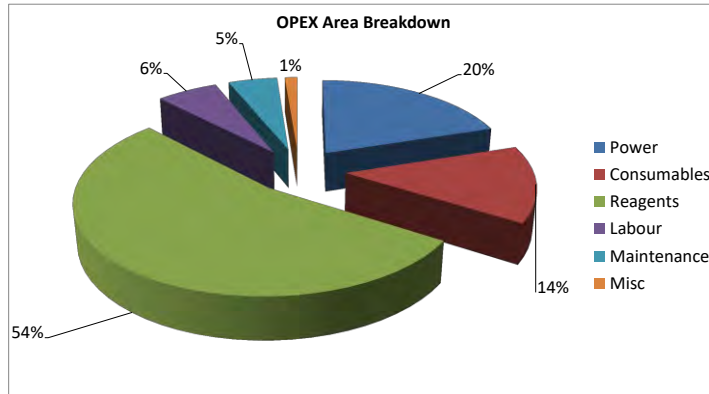

Rev	Date	Engineer	Comments
0	12/03/20	DC	Issue as draft to client
A	01/03/20	LZ	Revan proposal/active updated layout

Key Input	Only Adjust variables in Blue	Source of information
Throughput (tph)	2537	Calculation
Throughput (tpa)	20,000,000	Basis value
Availability (Crushing)	70%	METS assumed value
Availability (Grinding)	90%	METS assumed value
Operating Hour pa (Crushing)	6132	Calculation
Operating Hour pa (Grinding)	7884	Calculation
Exchange rate (1 NAD = 0.07 USD)	\$0.07	<a href="http://www.xe.com">www.xe.com</a>

Price List	Units	Price USD/unit	Source of information
Gyratory Crusher Liner - Mantle	set	\$150,000	
Gyratory Crusher Liner - Concave	set	\$150,000	
Cone Crusher Liners - Bowl	set	\$18,000	
Cone Crusher Liners - Mantle	set	\$18,000	
Secondary Screen	set	\$20,000	
HPGR Liner and Plates	set	\$1,149,512	Koppers
HPGR Double Deck Screen Liner	set	\$25,000	
Pad Liner	m <sup>2</sup>	\$8.4	
Irrigation Tubing	m	\$7	
Oil	t	\$900	
Grease	t	\$450	
Air Filters	set	\$3,745	
Mobile Lighting Tower Parts	set	\$700	
Light Vehicle Parts	set	\$350	
Water Truck Parts	set	\$2,100	
Forklift Parts	set	\$1,750	
Ambulance Parts/Consumables	set	\$700	
Sulphuric Acid	t	\$275.00	DAP Noordoewer
Polyacrylamide	t	\$2,150.00	DAP Noordoewer
LIX984N	t	\$12,000	
Quicklime	t	\$300	
Limestone	t	\$150	
Calcrete/Dolomite	t	\$12.50	Assumption, mining cost+crushing cost
Kerosene	t	\$550	
Raw Water	kL	\$0.92	Calculation
Flocculant	t	\$2,150	DAP Noordoewer
Diesel	L	\$0.94	<a href="http://globalpetrolprices.com">globalpetrolprices.com</a>
Cathode	set	\$150.00	
Anode	set	\$200.00	
Power Cost (N\$)	kWh	\$1.21	
Power Cost (US\$)	kWh	\$0.084	Calculation

\*Manipulation of the mass balance worksheet will automatically update the OPEX model



**Document** OPEX-20 Mtpa @ 85% Cu Recovery +CuSO4  
**Area** Labour  
**Client** Deep-South Resources  
**Project** Haib PEA  
**Job #** J5329  
**Doc #** J5329-ES-CA-000-001  
**Rev** A

Personnel	Annual Salary (N\$)	Annual Salary (USD)	Roster	Shift or D/N (D)	#	Total Cost (USD) per Annum	USD/t ROM	Crushing	Agglomeration and Heap Leaching	Copper SX and EW	Iron Removal and Tailings	Process and Raw Water	Reagents	Services	
<b>Process Plant</b>															
General Manager	\$2,255,964	\$157,917	Full Time	D	1	\$157,917	\$0.01	\$0.00	\$0.00	\$0.00	\$0.00	\$0.00	\$0.00	\$0.00	
Personal Assistant	\$296,184	\$20,733	Full Time	D	1	\$20,733	\$0.00	\$0.00	\$0.00	\$0.00	\$0.00	\$0.00	\$0.00	\$0.00	
<b>Processing</b>															
Process Manager	\$1,253,128	\$87,719	Full Time	D	1	\$87,719	\$0.00	\$0.00	\$0.00	\$0.00	\$0.00	\$0.00	\$0.00	\$0.00	
Plant Superintendent/Supervisor	\$1,123,128	\$78,619	Full Time	D	1	\$78,619	\$0.00	\$0.00	\$0.00	\$0.00	\$0.00	\$0.00	\$0.00	\$0.00	
Shift Supervisor	\$1,123,128	\$78,619	Full Time	D	1	\$78,619	\$0.00	\$0.00	\$0.00	\$0.00	\$0.00	\$0.00	\$0.00	\$0.00	
Plant Operator	\$296,184	\$20,733	4/3 DIDO	D/N	68	\$1,409,836	\$0.07	\$0.02	\$0.02	\$0.01	\$0.01	\$0.00	\$0.00	\$0.00	
Day Crew / Cleanup	\$296,184	\$20,733	4/3 DIDO	D	4	\$82,932	\$0.00	\$0.00	\$0.00	\$0.00	\$0.00	\$0.00	\$0.00	\$0.00	
Senior Metallurgist	\$1,253,128	\$87,719	4/3 DIDO	D	2	\$175,438	\$0.01	\$0.00	\$0.00	\$0.00	\$0.00	\$0.00	\$0.00	\$0.00	
Metallurgist / Process Engineer	\$1,123,128	\$78,619	4/3 DIDO	D	2	\$157,238	\$0.01	\$0.00	\$0.00	\$0.00	\$0.00	\$0.00	\$0.00	\$0.00	
Graduate Metallurgist	\$691,452	\$48,402	4/3 DIDO	D	2	\$96,803	\$0.00	\$0.00	\$0.00	\$0.00	\$0.00	\$0.00	\$0.00	\$0.00	
Metallurgical Accounting Clerk	\$691,452	\$48,402	4/3 DIDO	D	2	\$96,803	\$0.00	\$0.00	\$0.00	\$0.00	\$0.00	\$0.00	\$0.00	\$0.00	
Electrical/Process Control Engineer	\$1,253,128	\$87,719	4/3 DIDO	D	2	\$175,438	\$0.01	\$0.00	\$0.00	\$0.00	\$0.00	\$0.00	\$0.00	\$0.00	
Chief Chemist	\$1,253,128	\$87,719	Full Time	D	1	\$87,719	\$0.00	\$0.00	\$0.00	\$0.00	\$0.00	\$0.00	\$0.00	\$0.00	
Chemist	\$691,452	\$48,402	4/3 DIDO	D	1	\$48,402	\$0.00	\$0.00	\$0.00	\$0.00	\$0.00	\$0.00	\$0.00	\$0.00	
Laboratory Technician	\$480,516	\$33,636	4/3 DIDO	D	2	\$67,272	\$0.00	\$0.00	\$0.00	\$0.00	\$0.00	\$0.00	\$0.00	\$0.00	
<b>Maintenance</b>															
Maintenance Manager	\$1,253,128	\$87,719	Full Time	D	1	\$87,719	\$0.00	\$0.00	\$0.00	\$0.00	\$0.00	\$0.00	\$0.00	\$0.00	
Reliability Engineer	\$976,536	\$68,358	Full Time	D	1	\$68,358	\$0.00	\$0.00	\$0.00	\$0.00	\$0.00	\$0.00	\$0.00	\$0.00	
Mechanical Supervisor	\$691,452	\$48,402	4/3 DIDO	D	2	\$96,803	\$0.00	\$0.00	\$0.00	\$0.00	\$0.00	\$0.00	\$0.00	\$0.00	
Fitter	\$480,516	\$33,636	4/3 DIDO	D	3	\$100,908	\$0.01	\$0.00	\$0.00	\$0.00	\$0.00	\$0.00	\$0.00	\$0.00	
Boilermaker	\$480,516	\$33,636	4/3 DIDO	D	3	\$100,908	\$0.01	\$0.00	\$0.00	\$0.00	\$0.00	\$0.00	\$0.00	\$0.00	
Fitter / Boilermaker Apprentice	\$296,184	\$20,732.88	4/3 DIDO	D	5	\$103,664	\$0.01	\$0.00	\$0.00	\$0.00	\$0.00	\$0.00	\$0.00	\$0.00	
Trades Assisstant / Tool Storeman	\$338,772	\$23,714	4/3 DIDO	D	3	\$71,142	\$0.00	\$0.00	\$0.00	\$0.00	\$0.00	\$0.00	\$0.00	\$0.00	
Electrician	\$542,556	\$37,979	4/3 DIDO	D/N	6	\$227,874	\$0.01	\$0.00	\$0.00	\$0.00	\$0.00	\$0.00	\$0.00	\$0.00	
Instrumentation Technician	\$542,556	\$37,979	4/3 DIDO	D	2	\$75,958	\$0.00	\$0.00	\$0.00	\$0.00	\$0.00	\$0.00	\$0.00	\$0.00	
Electrical Apprentice	\$296,184	\$20,733	4/3 DIDO	D	2	\$41,466	\$0.00	\$0.00	\$0.00	\$0.00	\$0.00	\$0.00	\$0.00	\$0.00	
<b>Administration</b>															
Administration Manager	\$1,123,128	\$78,619	Full Time	D	1	\$78,619	\$0.00	\$0.00	\$0.00	\$0.00	\$0.00	\$0.00	\$0.00	\$0.00	
Senior Accountant	\$1,123,128	\$78,619	Full Time	D	1	\$78,619	\$0.00	\$0.00	\$0.00	\$0.00	\$0.00	\$0.00	\$0.00	\$0.00	
Reception and General Office	\$338,772	\$23,714	Full Time	D	1	\$23,714	\$0.00	\$0.00	\$0.00	\$0.00	\$0.00	\$0.00	\$0.00	\$0.00	
IT Officer	\$1,123,128	\$78,619	Full Time	D	1	\$78,619	\$0.00	\$0.00	\$0.00	\$0.00	\$0.00	\$0.00	\$0.00	\$0.00	
Shipping and Purchasing Officer	\$1,123,128	\$78,619	Full Time	D	1	\$78,619	\$0.00	\$0.00	\$0.00	\$0.00	\$0.00	\$0.00	\$0.00	\$0.00	
HR Superintendent	\$1,123,128	\$78,619	Full Time	D	1	\$78,619	\$0.00	\$0.00	\$0.00	\$0.00	\$0.00	\$0.00	\$0.00	\$0.00	
<b>Environmental and OH&amp;S</b>															
Environment, Health and Safety Manager	\$1,123,128	\$78,619	Full Time	D	1	\$78,619	\$0.00	\$0.00	\$0.00	\$0.00	\$0.00	\$0.00	\$0.00	\$0.00	
Environmental Officer	\$691,452	\$48,402	Full Time	D	1	\$48,402	\$0.00	\$0.00	\$0.00	\$0.00	\$0.00	\$0.00	\$0.00	\$0.00	
Safety and Training Co-ordinator	\$1,123,128	\$78,618.96	Full Time	D	1	\$78,619	\$0.00	\$0.00	\$0.00	\$0.00	\$0.00	\$0.00	\$0.00	\$0.00	
OH&S Technician	\$691,452	\$48,402	Full Time	D	1	\$48,402	\$0.00	\$0.00	\$0.00	\$0.00	\$0.00	\$0.00	\$0.00	\$0.00	
Emergency Response Co-ordinator	\$542,556	\$37,979	Full Time	D	1	\$37,979	\$0.00	\$0.00	\$0.00	\$0.00	\$0.00	\$0.00	\$0.00	\$0.00	
<b>On Costs -General</b>						\$1,374,061	\$0.07	\$0.02	\$0.02	\$0.01	\$0.01	\$0.00	\$0.00	\$0.00	
<b>On Costs - Messing</b>						\$0	\$0.00	\$0.00	\$0.00	\$0.00	\$0.00	\$0.00	\$0.00	\$0.00	
% Split								100%	30%	25%	15%	15%	5%	5%	
<b>Total</b>							<b>130</b>	<b>\$5,879,177</b>	<b>\$0.29</b>	<b>\$0.09</b>	<b>\$0.07</b>	<b>\$0.04</b>	<b>\$0.04</b>	<b>\$0.01</b>	<b>\$0.01</b>



**Document** OPEX-20 Mtpa @ 85% Cu Recovery +CuSO4  
**Area** Consumables  
**Client** Deep-South Resources  
**Project** Haib PEA  
**Job #** J5329  
**Doc #** J5329-ES-CA-000-001  
**Rev** A

Concentrator Area/ Equipment Name	Cost (USD) per unit	Unit	Consumption Rate/Unit/Year	Number of Units	Total quantity per Year	Total Cost (USD) per Annum	Estimated Freight Cost	Total Cost (USD) per Annum	USD/t ROM
<b>Crushing</b>									
Gyratory Crusher Liner - Mantle	\$200,000	set	2	1	4	\$800,000	\$72,000	\$872,000	\$0.04
Gyratory Crusher Liner - Concave	\$200,000	set	4	1	8	\$1,600,000	\$144,000	\$1,744,000	\$0.09
Cone Crusher Liners - Bowl	\$18,000	set	3	2	12	\$216,000	\$19,440	\$235,440	\$0.01
Cone Crusher Liners - Mantle	\$18,000	set	3	2	12	\$216,000	\$19,440	\$235,440	\$0.01
Secondary Screen	\$20,000	set	4	2	8	\$160,000	\$14,400	\$174,400	\$0.01
HPGR Liner and Plates	\$1,149,512	set	0.3	2	0.5	\$574,756	\$51,728	\$626,484	\$0.03
HPGR Double Deck Screen Liner	\$25,000	set	8	2	16	\$400,000	\$36,000	\$436,000	\$0.02
<b>Sub total - Crushing and Grinding</b>						<b>\$3,966,756</b>	<b>\$357,008</b>	<b>\$4,323,764</b>	<b>\$0.22</b>
<b>Agglomeration and Heap Leaching</b>									
Pad Clearance	\$0.65	m2	354918	1	354918	\$230,697		\$230,697	\$0.01
Pad Earthworks	\$2.50	m3	632023	1	632023	\$1,580,058		\$1,580,058	\$0.08
Pad Liner	\$8.40	m2	354918	1	354918	\$2,981,312	\$268,318.08	\$3,249,630	\$0.16
Irrigation Tubing	\$7.00	m	1795	3	5384	\$37,685	\$3,392	\$41,076	\$0.00
<b>Sub total - Agglomeration and Heap Leach</b>						<b>\$4,829,752</b>	<b>\$271,710</b>	<b>\$5,101,461</b>	<b>\$0.26</b>
<b>Electrowinning</b>									
Replacement Cathodes	\$150	set	2259	1	2259	\$338,820	\$30,494	\$369,314	\$0.02
Replacement Anodes	\$200	set	2259	1	2259	\$451,760	\$40,658	\$492,418	\$0.02
Copper Sulfate Bags	\$13	each	51081	1	51081	\$638,511	\$57,466	\$695,977	\$0.03
Copper Sulfate Pallets	\$15	each	51081	1	51081	\$766,213	\$68,959	\$835,172	\$0.04
<b>Sub total - Electrowinning</b>						<b>\$790,580</b>	<b>\$71,152</b>	<b>\$2,392,881</b>	<b>\$0.04</b>
<b>Services</b>									
Oil	\$900	t	2.54	365	926	\$833,333	\$75,000	\$908,333	\$0.05
Grease	\$450	t	2.54	365	926	\$416,667	\$37,500	\$454,167	\$0.02
Air Filters	\$3,745	set	1	1	1	\$1,873	\$169	\$2,041	\$0.00
<b>Sub total - Services</b>						<b>\$1,251,873</b>	<b>\$112,669</b>	<b>\$1,364,541</b>	<b>\$0.07</b>
<b>Misc</b>									
Mobile Lighting Tower Parts	\$700	set	1	3	3	\$2,100	\$189	\$2,289	\$0.00
Light Vehicle Parts	\$350	set	1	6	6	\$2,100	\$189	\$2,289	\$0.00
Water Truck Parts	\$2,100	set	1	1	1	\$2,100	\$189	\$2,289	\$0.00
Forklift Parts	\$1,750	set	1	2	2	\$3,500	\$315	\$3,815	\$0.00
Ambulance Parts/Consumables	\$700	set	1	1	1	\$700	\$63	\$763	\$0.00
<b>Sub total - Misc</b>						<b>\$10,500</b>	<b>\$945</b>	<b>\$11,445</b>	<b>\$0.00</b>
<b>Total</b>						<b>\$10,849,460</b>	<b>\$813,483</b>	<b>\$13,194,092</b>	<b>\$0.58</b>





Document  
Area  
Client  
Project  
Job #  
Doc #  
Rev

OPEX-20 Mtpa @ 85% Cu Recovery +CuSO4  
Reagents  
Deep-South Resources  
Haib PEA  
J5329  
J5329-ES-CA-000-001  
A

Reagents	USD per unit CIF Luderitz	Unit	Consumed per Year	Reagent Cost (USD) per Annum	Transport Cost (USD) Port to Haib	Total Cost (USD) per Annum	USD/t ROM
Sulphuric Acid	\$275	t	37,607	10,341,957	1,692,320	\$12,034,277	\$0.60
Polyacrylamide	\$2,150	t	2,927	6,293,591	131,726	\$6,425,317	\$0.32
LIX984N	\$12,000	t	548	6,581,306	24,680	\$6,605,986	\$0.33
Quicklime	\$300	t	14,418	4,325,279	648,792	\$4,974,071	\$0.25
Limestone	\$150	t	67,327	10,098,978	3,029,694	\$13,128,672	\$0.66
Calcrete/Dolomite	\$12.50	t	0	0		\$0	\$0.00
Kerosene	\$550	t	3,108	1,709,311	139,853	\$1,849,164	\$0.09
Raw Water	\$0.92	kL	2,477,021	2,269,694	0	\$2,269,694	\$0.11
Flocculant	\$2,150	t	127	272,402	5,701	\$278,103	\$0.01
Diesel	\$0.94	L	3,923,449	3,680,195	210,185	\$3,890,380	\$0.19
<b>Total</b>						<b>\$51,455,665</b>	<b>\$2.57</b>

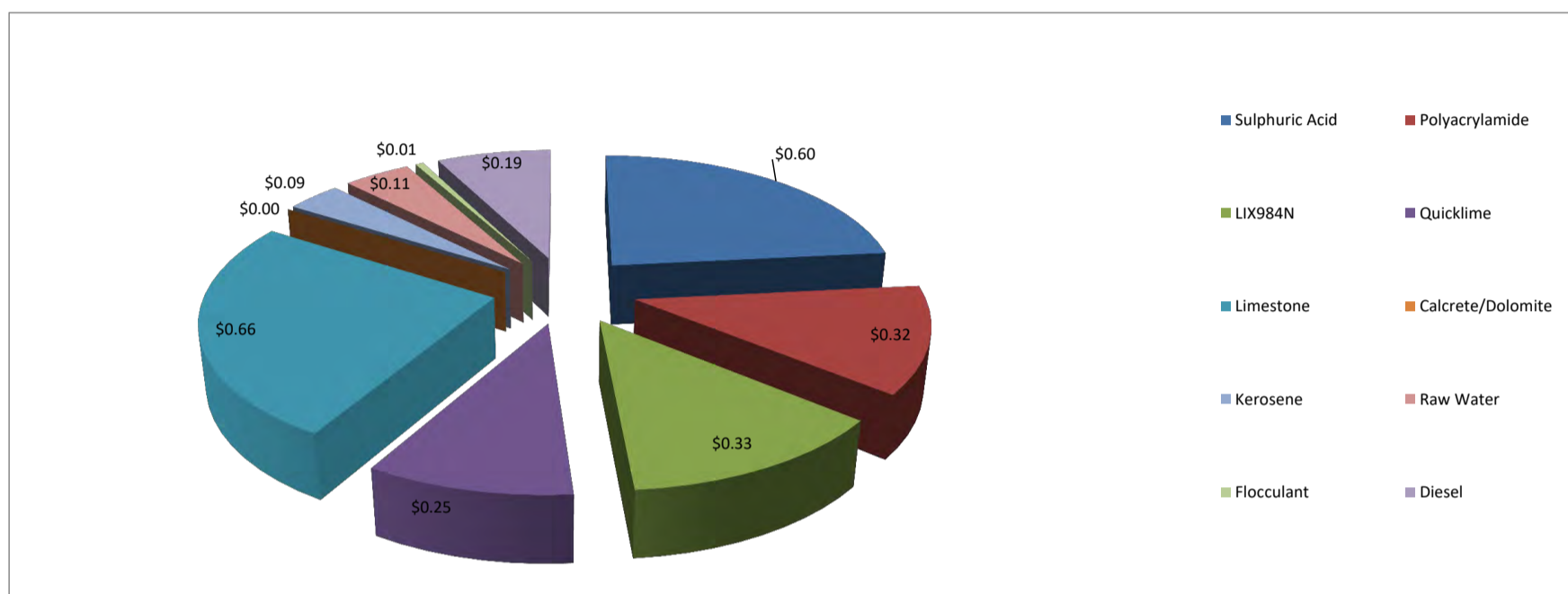



**Document** OPEX-20 Mtpa @ 85% Cu Recovery +CuSO4  
**Area** Power  
**Client** Deep-South Resources  
**Project** Haib PEA  
**Job #** J5329  
**Doc #** J5329-ES-CA-000-001  
**Rev** A

Concentrator Area/ Equipment Name	Installed Power (kW)	Utilisation %	Power Draw (kW)	Operating Hours	Consumption (kWHPa)	Total Cost (USD) per Annum	USD/t ROM
Crushing	7,072	70	4950	6,132	30,355,149	\$2,560,882	\$0.13
HPGR	8,607	90	7746	7,884	61,071,929	\$5,152,272	\$0.26
Agglomeration and Heap Leaching	3,808	98	3732	8,585	32,036,730	\$2,702,747	\$0.14
Copper SX and EW	13,785	90	12407	7,884	97,814,727	\$8,252,042	\$0.41
Iron Removal and Tailings	313	90	281	7,884	2,219,131	\$187,215	\$0.01
Process and Raw Water	452	90	407	7,884	3,209,730	\$270,786	\$0.01
Reagents	39	90	35	7,884	278,942	\$23,533	\$0.00
Services	28	70	20	7,884	157,007	\$13,246	\$0.00
<b>Total</b>	<b>34,105</b>		<b>29,579</b>		<b>227,143,346</b>	<b>\$19,162,721</b>	<b>\$0.96</b>

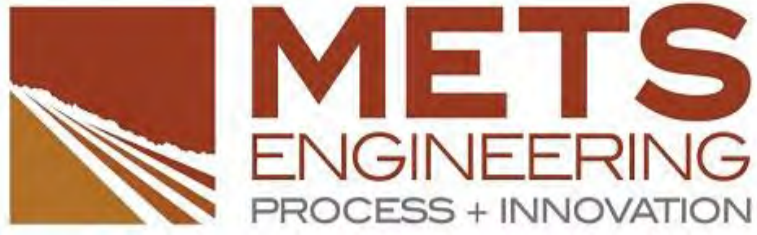

**Document** OPEX-20 Mtpa @ 85% Cu Recovery +CuSO4  
**Area** Maintenance  
**Client** Deep-South Resources  
**Project** Haib PEA  
**Job #** J5329  
**Doc #** J5329-ES-CA-000-001  
**Rev** A

Area	Mechanical CAPEX (USD)	Maintenance Cost (%)	Maintenance Cost per year (USD)	USD/t ROM
Crushing	\$33,812,000	5%	\$1,690,600	\$0.08
HPGR	\$24,532,000	5%	\$1,226,600	\$0.06
Agglomeration and Heap Leaching	\$25,049,000	1%	\$250,490	\$0.01
Copper SX and EW	\$41,908,000	3%	\$1,257,240	\$0.06
Iron Removal and Tailings	\$3,613,000	3%	\$108,390	\$0.01
Process and Raw Water	\$2,357,000	1%	\$23,570	\$0.00
Reagents	\$2,924,200	3%	\$87,726	\$0.00
Services	\$1,633,000	3%	\$48,990	\$0.00
<b>Total</b>	<b>\$135,828,200</b>		<b>\$4,693,606</b>	<b>\$0.23</b>